

Matching Transformer

Z7550-FFSF+

50/75Ω

DC to 2500 MHz



Generic photo used for illustration purposes only
CASE STYLE: H557-1

The Big Deal

- Low Insertion loss 0.5 dB typical.
- Wideband coverage, DC-2500 MHz
- Maximum DC current handling capability of 5A
- 2W power handling
- SMA-F (50Ω) to F-Type-F (75Ω) Connectors

Product Overview

Mini-Circuits' Z7550-FFSF+ is a coaxial 50/75Ω matching transformer covering the DC to 2500 MHz frequency range, supporting impedance matching in a wide range of systems including CATV, broadband networks, and more. This model is ideal for 50/75Ω impedance matching in systems where minimizing overall signal loss is a priority. The transformer handles RF input power up to 2W and comes housed in a rugged, compact aluminum alloy case (1.25 x 1.25 x 0.75") with SMA-F (50Ω) to F-Type-F (75Ω) connectors.

Key Features

Feature	Advantages
Wideband, DC to 2500 MHz	Supports a wide variety of applications including CATV and DOCSIS® 3.1 systems and equipment.
Low insertion loss, 0.5 dB	Enables excellent signal power transmission from input to output, minimizing overall system losses.
2W Power handling	Supports a range of system power requirements.
Compact size, 1.25 x 1.25 x 0.75"	Accommodates tight space requirements for crowded system layouts.
Connectorized package SMA-F (50Ω) to F-Type-F (75Ω) connectors	Supports connections between components with different connector types.

Notes

- A. Performance and quality attributes and conditions not expressly stated in this specification document are intended to be excluded and do not form a part of this specification document.
B. Electrical specifications and performance data contained in this specification document are based on Mini-Circuit's applicable established test performance criteria and measurement instructions.
C. The parts covered by this specification document are subject to Mini-Circuits standard limited warranty and terms and conditions (collectively, "Standard Terms"); Purchasers of this part are entitled to the rights and benefits contained therein. For a full statement of the Standard Terms and the exclusive rights and remedies thereunder, please visit Mini-Circuits' website at www.minicircuits.com/MCLStore/terms.jsp



Matching Transformer

Z7550-FFSF+

50/75Ω

DC to 2500 MHz



Generic photo used for illustration purposes only
CASE STYLE: H557-1

Connectors	Model
75Ω F-F	Z7550-FFSF+
50Ω S-F	

+RoHS Compliant

The +Suffix identifies RoHS Compliance. See our web site for RoHS Compliance methodologies and qualifications

Maximum Ratings

Operating Temperature	-55°C to 100°C
Storage Temperature	-55°C to 100°C
DC Current	5A max.
DC Resistance	0.2Ω max.

Permanent damage may occur if any of these limits are exceeded.

Features

- Low loss (0.5 dB) matching device
- Wideband coverage, DC-2500MHz
- Maximum DC current handling capability of 5A
- Connectorized package

Applications

- Impedance matching
- CATV

Coaxial Connections

Input	SMA-Female
Output	F-Female

Outline Drawing

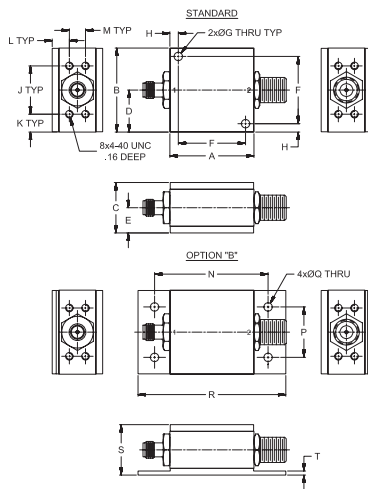

Outline Dimensions (inch mm)

A	B	C	D	E	F	G	H	J	K
1.25	1.25	.75	.63	.38	1.00	.13	.125	.72	.27
31.75	31.75	19.05	15.88	9.53	25.40	3.18	3.18	18.24	6.76
L	M	N	P	Q	R	S	T		Wt.
.26	.24	1.69	.75	.13	2.20	.75	.06		grams
6.48	6.10	42.88	19.05	3.18	55.83	19.05	1.52		37

Note: Please refer to case style drawing for details

Electrical Specifications at 25°C

Parameter	Frequency (MHz)	Min.	Typ.	Max.	Unit
Frequency Range	-	DC	-	2500	MHz
Insertion Loss	10	-	-	1.0	dB
	950-2500	-	0.5	1.2	
VSWR	10	-	-	1.8	:1
	950-2500	-	-	1.7	
Power	DC-2500	-	-	2	W

Typical Performance Data

Frequency (MHz)	Insertion Loss (dB)	VSWR	
		50 Ω	75 Ω
10	0.01	1.50	1.50
50	0.04	1.50	1.49
100	0.08	1.50	1.49
250	0.21	1.47	1.46
300	0.26	1.46	1.45
950	0.26	1.30	1.31
1500	0.30	1.14	1.09
2150	0.40	1.12	1.10
2300	0.41	1.11	1.10
2500	0.42	1.09	1.09

Functional Schematic

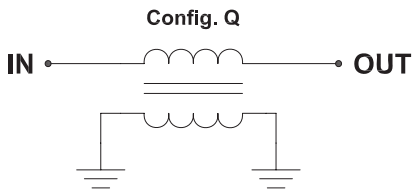

Notes

- Performance and quality attributes and conditions not expressly stated in this specification document are intended to be excluded and do not form a part of this specification document.
- Electrical specifications and performance data contained in this specification document are based on Mini-Circuit's applicable established test performance criteria and measurement instructions.
- The parts covered by this specification document are subject to Mini-Circuits standard limited warranty and terms and conditions (collectively, "Standard Terms"); Purchasers of this part are entitled to the rights and benefits contained therein. For a full statement of the Standard Terms and the exclusive rights and remedies thereunder, please visit Mini-Circuits' website at www.minicircuits.com/MCLStore/terms.jsp

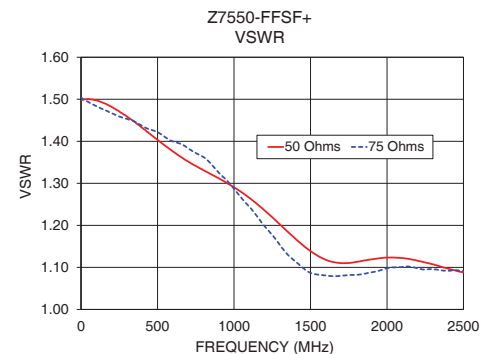
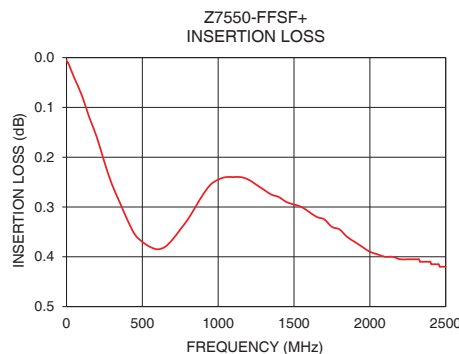

Typical Performance Data

FREQ.	INSERTION LOSS	INPUT RETURN LOSS (50Ω)	OUTPUT RETURN LOSS (75Ω)
(MHz)	(dB)	(dB)	(dB)
1.00	0.01	13.99	13.92
10.00	0.01	13.99	13.96
50.00	0.04	13.97	14.05
100.00	0.08	14.02	14.19
150.00	0.12	14.11	14.31
200.00	0.16	14.24	14.43
225.00	0.19	14.32	14.49
250.00	0.21	14.40	14.56
275.00	0.24	14.49	14.61
300.00	0.26	14.58	14.66
350.00	0.29	14.78	14.74
375.00	0.31	14.89	14.81
400.00	0.33	15.01	14.90
450.00	0.36	15.25	15.05
500.00	0.37	15.50	15.16
525.00	0.38	15.63	15.24
550.00	0.38	15.76	15.34
600.00	0.39	16.01	15.54
650.00	0.38	16.26	15.65
700.00	0.37	16.50	15.82
725.00	0.36	16.62	15.94
750.00	0.35	16.73	16.06
800.00	0.33	16.95	16.24
825.00	0.32	17.06	16.36
850.00	0.30	17.17	16.54
875.00	0.29	17.28	16.76
900.00	0.28	17.40	16.99
925.00	0.27	17.52	17.21
950.00	0.26	17.65	17.41
975.00	0.25	17.79	17.64
1000.00	0.25	17.93	17.91
1025.00	0.24	18.09	18.21
1050.00	0.24	18.25	18.53
1075.00	0.24	18.43	18.84
1100.00	0.24	18.62	19.14
1150.00	0.24	19.06	19.85
1200.00	0.25	19.55	20.72
1225.00	0.25	19.82	21.17
1250.00	0.26	20.11	21.62
1300.00	0.27	20.75	22.70
1400.00	0.28	22.19	25.11
1500.00	0.30	23.76	27.45
1600.00	0.31	25.08	28.20
1650.00	0.32	25.46	28.37
1700.00	0.33	25.64	28.33
1750.00	0.34	25.62	28.16
1800.00	0.35	25.44	28.06
1850.00	0.36	25.20	27.90
1900.00	0.37	25.00	27.55
1950.00	0.38	24.83	27.18
2000.00	0.39	24.73	26.69
2050.00	0.40	24.72	26.43
2075.00	0.40	24.75	26.45
2100.00	0.40	24.80	26.38
2125.00	0.40	24.87	26.29
2150.00	0.40	24.97	26.29
2200.00	0.41	25.24	26.55
2250.00	0.41	25.53	26.87
2300.00	0.41	25.87	26.74
2500.00	0.42	27.52	27.17

Typical Performance Curves

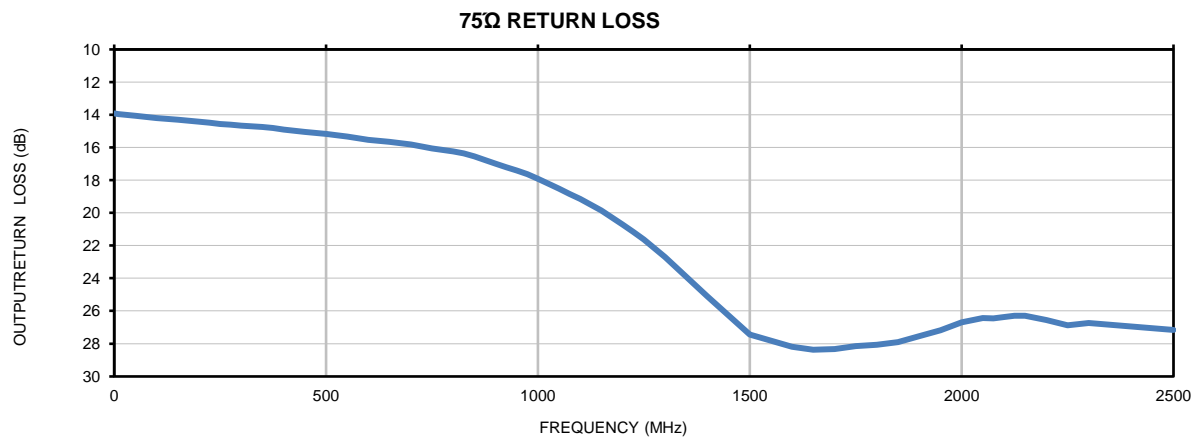
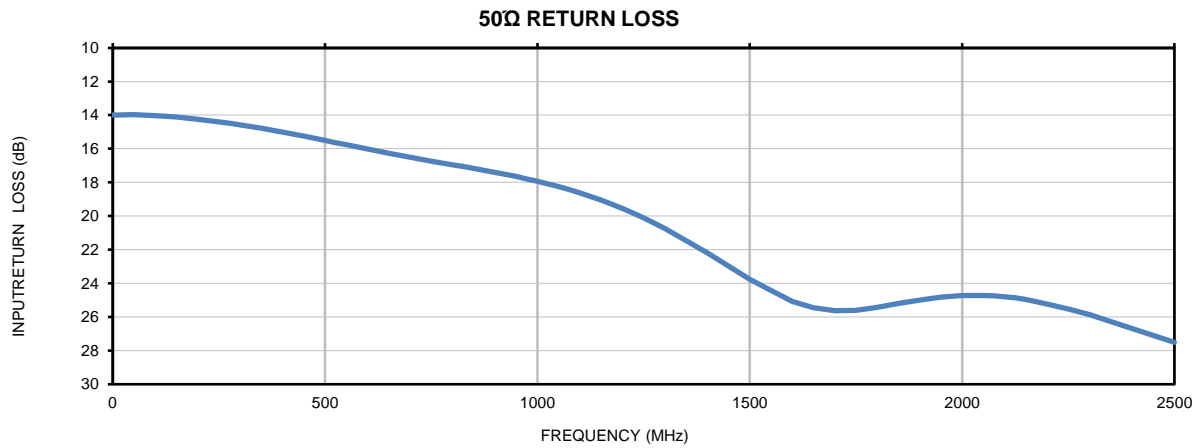

Outline Dimensions

H557-1

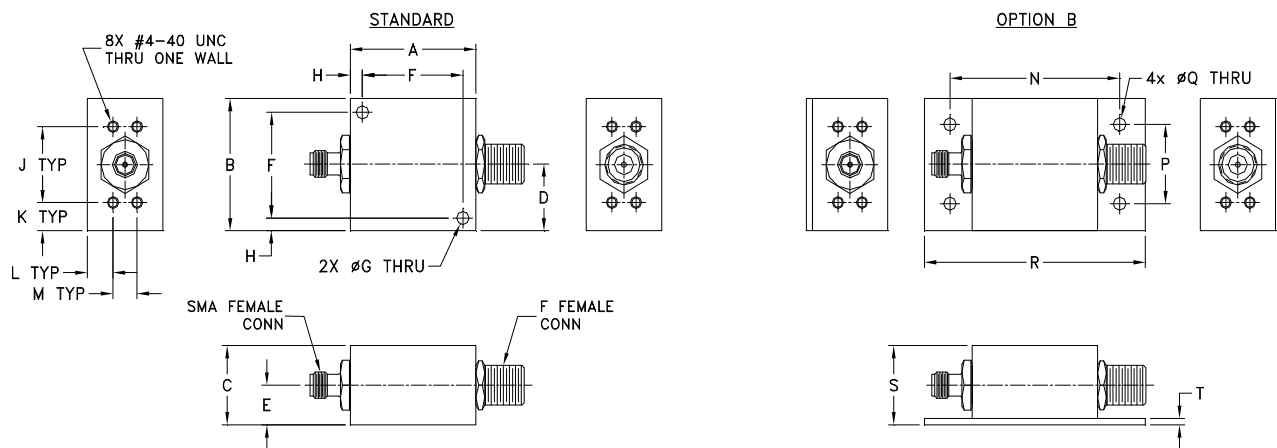

CASE#	A	B	C	D	E	F	G	H	J	K	L
H557-1	1.25 (31.75)	1.25 (31.75)	.75 (19.05)	.63 (15.88)	.38 (9.53)	1.000 (25.40)	.125 (3.18)	.125 (3.18)	.718 (18.24)	.27 (6.76)	.255 (6.48)

CASE#	M	N	P	Q	R	S	T	WT.GRAMS
H557-1	.240 (6.10)	1.69 (42.88)	.75 (19.05)	.13 (3.18)	2.20 (55.83)	.75 (19.05)	.06 (1.52)	37

Dimensions are in inches (mm). Tolerances: 2PL. ± .03; 3PL. ± .015

Notes:

1. Case material: Aluminum alloy.
2. Case finish:
For RoHS Case Styles: Clear chemical conversion coating, non-chrome or trivalent chrome based.
3. Refer to the individual model data sheet for the type of connectors available.
4. Mounting bracket available on request. Add suffix B to part number.

Mini-Circuits®
ISO 9001 ISO 14001 CERTIFIED

ALL NEW
minicircuits.com

P.O. Box 350166, Brooklyn, New York 11235-0003 (718) 934-4500 Fax (718) 332-4661 For detailed performance specs & shopping online see Mini-Circuits web site



The Design Engineers Search Engine Provides ACTUAL Data Instantly From MINI-CIRCUITS At: www.minicircuits.com

RF/IF MICROWAVE COMPONENTS

All Mini-Circuits products are manufactured under exacting quality assurance and control standards, and are capable of meeting published specifications after being subjected to any or all of the following physical and environmental test.

Specification	Test/Inspection Condition	Reference/Spec
Operating Temperature	-55° to 100°C Ambient Environment	Individual Model Data Sheet
Storage Temperature	-55° to 100° C Ambient Environment	Individual Model Data Sheet
Barometric Pressure	100,000 Feet	MIL-STD-202, Method 105, Condition D
Humidity	90% RH, 65°C Units may require bake-out after humidity to restore full performance.	MIL-STD-202, Method 103
Thermal Shock	-65° to 125°C, 5 cycles	MIL-STD-202, Method 107, Condition B
Vibration (High Frequency)	20g peak, 10-2000 Hz, 12 times in each of three perpendicular directions (total 36)	MIL-STD-202, Method 204, Condition D
Mechanical Shock	100g, 6ms sawtooth, 3 shocks each direction 3 axes (total 18)	MIL-STD-202, Method 213, Condition I