

The Big Deal:

- Excellent Combination of gain, P1dB, IP3 and NF
- Flat Gain Response:
± 2.2 dB over 900-3200 MHz
- 50Ω Input and Output:
no External Components Required



CASE STYLE: DL1636

LTE Performance

Product Overview:

YSF-322+ is an advanced amplifier module in a Mini-Circuits System In Package **MSiP[®]**. This module is fully matched to 50Ω in/out impedance and has built-in Input & Output DC block capacitors. It is enclosed in a 5 x 6 mm MCLP plastic package. The YSF-322+ uses E-PHEMT technology enabling it to work with a single positive supply voltage.

Key Features

Feature	Advantages
Strong Combination of Performance	The YSF-322+ provides a strong combination of performance parameters including high gain (20 dB), high IP3 (+35 dBm) and P1dB (+20 dBm) and low noise figures (2.8 dB) that are difficult to achieve in a single stage design and available only in the YSF amplifier series.
Broadband Gain Flatness ± 2.2dB	The YSF-322+ provides outstanding gain flatness over a broad frequency range covering 900 to 3200 MHz making this ideal for use in applications where gain-flatness and repeatability are critical performance requirements.
High Gain	The YSF-322+ is a two-stage design with internal feedback and bias to provide flat 20 dB nominal gain, supporting applications where a single gain block must overcome large system losses such as long cable runs and lossy components.
Integrated Matching, DC Blocking and Bias in Small Package	The YSF-322+ includes all support circuits including: Matching, Bias and DC Blocking, all integrated into a single 5x6mm package making the total footprint equal to or smaller than most solutions.
Excellent Return Loss	The YSF-322+ includes integrated input and output matching and bias circuits to make this amplifier a simple, complete drop-in solution. The matching circuits provide excellent output return loss (20dB), and are designed to give optimal P1dB and IP3 performance in a 50Ω environment.
High Reverse Isolation	With 30 dB of reverse isolation – the YSF-322+ is an ideal gain block for use in integrated systems to minimize VSWR interactions resulting from cascading highly reflective components such as sharp filters.

Notes

- A. Performance and quality attributes and conditions not expressly stated in this specification document are intended to be excluded and do not form a part of this specification document.
 B. Electrical specifications and performance data contained in this specification document are based on Mini-Circuit's applicable established test performance criteria and measurement instructions.
 C. The parts covered by this specification document are subject to Mini-Circuits standard limited warranty and terms and conditions (collectively, "Standard Terms"); Purchasers of this part are entitled to the rights and benefits contained therein. For a full statement of the Standard Terms and the exclusive rights and remedies thereunder, please visit Mini-Circuits' website at www.minicircuits.com/MCLStore/terms.jsp



Wideband Amplifier

0.9-3.2 GHz

Product Features

- Matched 50-ohm surface mount amplifier
- High gain, 20 dB typ. at 2 GHz
- Up to +20 dBm typ. output power at 2 GHz
- High IP3, +35 dBm at 2 GHz
- Low Noise Figure, 2.8 dB typ. at 2 GHz
- High directivity, 30 dB isolation
- Internal Input & Output DC Block
- Separate terminal for DC
- Protected by us patent 8,994,157



YSF-322+

CASE STYLE: DL1636

Typical Applications

- Cellular
- Portable Wireless
- Receivers & transmitters
- Radar
- GSM
- WiMax
- Instrumentation

+RoHS Compliant

The +Suffix identifies RoHS Compliance. See our web site for RoHS Compliance methodologies and qualifications

LTE Performance

General Description

YSF-322+ is an advanced amplifier module in a Mini-Circuits System In Package MSiP[®]. This module is fully matched to 50Ω in/out impedance and has built-in Input & Output DC block capacitors. It is enclosed in a 5 x 6 mm MCLP plastic package. The YSF-322+ uses E-PHEMT* technology enabling it to work with a single positive supply voltage.

simplified schematic and pad description

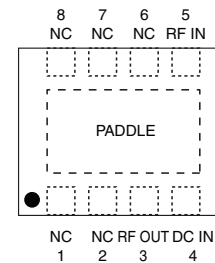
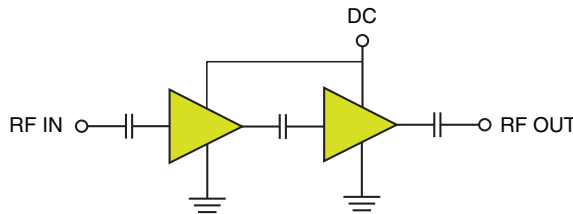

Function	Pad Number	Description
RF-IN	5	RF Input
RF-OUT	3	RF Output
DC	4	DC Supply
GND	Paddle	Connected to ground
NOT USED	1,2,6,7,8	No internal connection

*Enhancement mode Pseudomorphic High Electron Mobility Transistor

Notes

- A. Performance and quality attributes and conditions not expressly stated in this specification document are intended to be excluded and do not form a part of this specification document.
 B. Electrical specifications and performance data contained in this specification document are based on Mini-Circuit's applicable established test performance criteria and measurement instructions.
 C. The parts covered by this specification document are subject to Mini-Circuits standard limited warranty and terms and conditions (collectively, "Standard Terms"); Purchasers of this part are entitled to the rights and benefits contained therein. For a full statement of the Standard Terms and the exclusive rights and remedies thereunder, please visit Mini-Circuits' website at www.minicircuits.com/MCLStore/terms.jsp



Electrical Specifications⁽¹⁾ at 25°C, Zo=50Ω unless noted

Parameter	Condition (MHz)	Min.	Typ.	Max.	Units
Frequency Range		900		3200	MHz
Gain	900	18.6	20.4	22.4	dB
	1700	17.8	19.8	22.0	
	2500	17.1	19.0	21.5	
	3200	14.4	16.0	18.6	
Gain Flatness			± 2.2		dB
Input Return Loss	900	—	10.0		dB
	1700	—	10.0		
	2500	10.0	15.0		
	3200	—	21.0		
Output Return Loss	900	—	14.0		dB
	1700	—	23.5		
	2500	12.0	17.0		
	3200	—	10.4		
Reverse Isolation			30.0		dB
Output Power @ 1 dB compression	900	—	20.0		dBm
	1700	—	20.0		
	2500	18.0	20.0		
	3200	—	20.0		
Output Power @ 3 dB compression			21.0		dBm
Output IP3	900	—	36.0		dBm
	1700	30.0	35.0		
	2500	—	35.0		
	3200	—	35.0		
Noise Figure	900		3.5	—	dB
	1700		3.0	4.0	
	2500		2.5	—	
	3200		2.5	—	
Device Operating Voltage			5		V
Device Operating Current			118	145	mA
Device Current Variation vs. Temperature ⁽²⁾			2		μA/°C
Device Current Variation vs Voltage			0.002		mA/mV
Thermal Resistance, junction-to-ground lead ⁽³⁾			56		°C/W

⁽¹⁾ Measured on Mini-Circuits Characterization test board TB-616+. See Characterization Test Circuit (Fig. 1)

⁽²⁾ D(+85°C to -45°C)

⁽³⁾ Thermal Resistance= $\frac{\text{Hot spot temperature} - \text{Ground lead temperature}}{\text{Power Dissipation}}$

Absolute Maximum Ratings

Parameter	Ratings	Units
Operating Temperature ⁽⁴⁾	-40 to 85	°C
Storage Temperature	-65 to 150	°C
DC Voltage on Pad 4	7	V
Power Dissipation	1.5	W
Input Power	21	dBm

Note: Permanent damage may occur if any of these limits are exceeded. These ratings are not intended for continuous normal operation.

⁽⁴⁾ Case is defined as ground paddle.

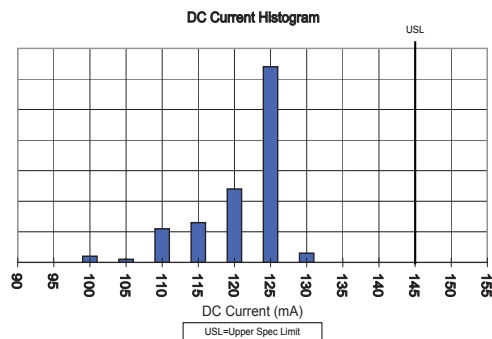

Notes

- A. Performance and quality attributes and conditions not expressly stated in this specification document are intended to be excluded and do not form a part of this specification document.
- B. Electrical specifications and performance data contained in this specification document are based on Mini-Circuit's applicable established test performance criteria and measurement instructions.
- C. The parts covered by this specification document are subject to Mini-Circuits standard limited warranty and terms and conditions (collectively, "Standard Terms"); Purchasers of this part are entitled to the rights and benefits contained therein. For a full statement of the Standard Terms and the exclusive rights and remedies thereunder, please visit Mini-Circuits' website at www.minicircuits.com/MCLStore/terms.jsp



Characterization Test Circuit

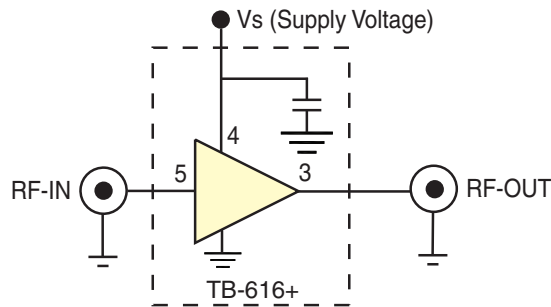

Fig 1. Block Diagram of Test Circuit used for characterization. (DUT soldered on Mini-Circuits Characterization Test Fixture TB-616+) Gain, Return loss, Output power at 1dB compression (P1 dB), Output IP3 (OIP3) and Noise Figure measured using Agilent's N5242A PNA-X microwave network analyzer.

Conditions:

1. Gain: Pin= -25dBm
2. Output IP3 (OIP3): Two tones, spaced 1 MHz apart, 0 dBm/tone at output.

Recommended Application Circuit

(refer to evaluation board for PCB Layout and component values)

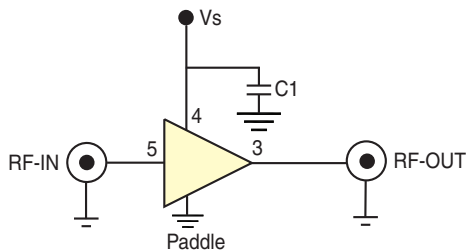
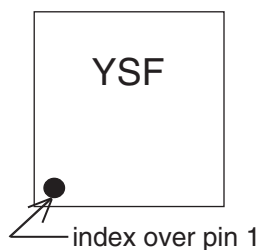

Fig 2. Recommended Application Circuit

Product Marking



Notes

- A. Performance and quality attributes and conditions not expressly stated in this specification document are intended to be excluded and do not form a part of this specification document.
- B. Electrical specifications and performance data contained in this specification document are based on Mini-Circuit's applicable established test performance criteria and measurement instructions.
- C. The parts covered by this specification document are subject to Mini-Circuits standard limited warranty and terms and conditions (collectively, "Standard Terms"); Purchasers of this part are entitled to the rights and benefits contained therein. For a full statement of the Standard Terms and the exclusive rights and remedies thereunder, please visit Mini-Circuits' website at www.minicircuits.com/MCLStore/terms.jsp

Additional Detailed Technical Information	
<i>additional information is available on our dash board. To access this information click here</i>	
Performance Data	Data Table
	Swept Graphs
	S-Parameter (S2P Files) Data Set (.zip file)
Case Style	DL1636 <i>Plastic package, exposed paddle, lead finish: tin/silver/nickel</i>
Tape & Reel Standard quantities available on reel	F68 <i>7" reels with 20, 50, 100, 200, 500 or 1K devices. 13" reels with 2K, or 4K devices.</i>
Suggested Layout for PCB Design	PL-352
Evaluation Board	TB-616-1+
Environmental Ratings	ENV08T1

ESD Rating

Human Body Model (HBM): Class 1A in accordance with ANSI/ESD STM 5.1 - 2001

Machine Model (MM): Class M1 (25V) in accordance with ANSI/ESD STM5.2-1999



Attention
 Observe precautions
 for handling electrostatic
 sensitive devices

MSL Rating

Moisture Sensitivity: MSL1 in accordance with IPC/JEDEC J-STD-020D

MSL Test Flow Chart

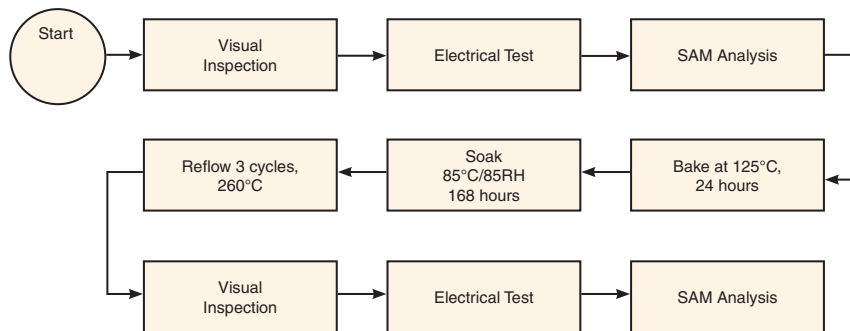

Notes

- A. Performance and quality attributes and conditions not expressly stated in this specification document are intended to be excluded and do not form a part of this specification document.
- B. Electrical specifications and performance data contained in this specification document are based on Mini-Circuit's applicable established test performance criteria and measurement instructions.
- C. The parts covered by this specification document are subject to Mini-Circuits standard limited warranty and terms and conditions (collectively, "Standard Terms"); Purchasers of this part are entitled to the rights and benefits contained therein. For a full statement of the Standard Terms and the exclusive rights and remedies thereunder, please visit Mini-Circuits' website at www.minicircuits.com/MCLStore/terms.jsp



Typical Performance Data

NOTE: Use PDF Bookmarks to view DATA at required conditions

Definitions:

Input Return Loss = -S11 (dB)

Gain(Power Gain) = S21 (dB)

Reverse Isolation = -S12 (dB)

Output Return Loss = -S22 (dB)

TEST CONDITIONS: Vd = 5.00V, Id=122.35mA @ Temperature = +25degC

FREQ	Gain	Isolation	Input Return Loss	Output Return Loss	Stability		IP-3 Output	1dB Comp. Output	Noise Figure
					K	Measure			
(MHz)	(dB)	(dB)	(dB)	(dB)	K	Measure	(dBm)	(dBm)	(dB)
900.0	20.65	32.53	11.13	15.25	1.87	0.99	37.57	20.86	3.44
950.0	20.69	32.33	11.79	15.95	1.86	0.98	37.25	20.89	3.36
1000.0	20.69	32.13	12.25	16.66	1.83	0.97	37.35	20.92	3.41
1050.0	20.66	31.75	12.60	17.39	1.78	0.97	37.10	20.90	3.39
1100.0	20.62	31.71	12.70	18.03	1.79	0.97	37.18	20.87	3.36
1150.0	20.55	31.53	12.69	18.54	1.77	0.97	36.97	20.90	3.32
1200.0	20.49	31.46	12.59	19.02	1.77	0.97	36.81	20.81	3.31
1250.0	20.43	31.33	12.42	19.45	1.76	0.98	36.94	20.77	3.27
1300.0	20.36	31.12	12.28	19.96	1.73	0.98	37.02	20.81	3.27
1350.0	20.30	31.14	12.10	20.44	1.74	0.98	36.87	20.79	3.21
1400.0	20.25	31.02	11.94	20.78	1.73	0.98	36.47	20.80	3.19
1450.0	20.21	30.96	11.80	21.01	1.72	0.99	36.37	20.73	3.14
1500.0	20.17	30.89	11.68	21.24	1.71	0.99	36.16	20.64	3.12
1550.0	20.14	30.69	11.59	21.47	1.68	0.99	36.34	20.71	3.06
1600.0	20.12	30.82	11.52	21.70	1.71	0.99	36.09	20.68	3.02
1650.0	20.11	30.75	11.45	22.12	1.70	0.99	36.12	20.71	2.97
1700.0	20.12	30.66	11.46	22.34	1.68	0.99	36.12	20.79	2.92
1750.0	20.12	30.63	11.43	22.47	1.68	0.99	35.84	20.76	2.89
1800.0	20.14	30.52	11.44	22.48	1.66	0.99	36.05	20.76	2.81
1850.0	20.15	30.64	11.55	22.48	1.68	0.99	35.76	20.81	2.80
1900.0	20.17	30.44	11.60	22.67	1.65	0.98	35.73	20.80	2.80
1950.0	20.20	30.53	11.70	22.80	1.66	0.98	35.83	20.81	2.90
2000.0	20.22	30.55	11.84	22.87	1.66	0.98	35.73	20.85	2.72
2050.0	20.24	30.42	12.00	22.77	1.65	0.97	35.87	20.81	2.69
2100.0	20.25	30.45	12.25	22.66	1.65	0.97	35.59	20.81	2.65
2150.0	20.25	30.48	12.46	22.40	1.66	0.96	35.58	20.84	2.60
2200.0	20.25	30.53	12.75	22.04	1.68	0.96	35.60	20.86	2.64
2250.0	20.22	30.52	13.19	21.65	1.69	0.95	35.60	20.87	2.55
2300.0	20.16	30.71	13.61	21.40	1.74	0.95	35.49	20.90	2.57
2350.0	20.11	30.67	14.03	20.68	1.75	0.94	35.51	20.88	2.47
2400.0	20.05	30.66	14.46	20.01	1.77	0.94	35.49	20.90	2.47
2450.0	19.97	30.79	14.90	19.24	1.81	0.94	35.57	20.91	2.50
2500.0	19.88	30.82	15.40	18.50	1.83	0.93	35.58	20.91	2.49
2550.0	19.77	30.88	16.06	17.71	1.87	0.93	35.62	20.86	2.45
2600.0	19.63	30.87	16.85	16.96	1.90	0.92	35.92	20.88	2.43
2650.0	19.49	30.96	17.48	16.17	1.94	0.92	35.66	20.85	2.38
2700.0	19.34	30.95	18.20	15.53	1.97	0.91	36.03	20.79	2.44
2750.0	19.16	31.09	19.03	14.89	2.03	0.91	36.27	20.87	2.39
2800.0	19.00	31.06	19.66	14.41	2.05	0.90	36.14	20.82	2.30
2850.0	18.81	31.05	20.34	13.93	2.08	0.90	36.24	20.79	2.40
2900.0	18.62	31.08	20.93	13.41	2.13	0.90	36.27	20.79	2.38
2950.0	18.40	31.02	21.59	12.91	2.15	0.89	36.59	20.78	2.38
3000.0	18.20	31.04	21.46	12.48	2.19	0.89	36.53	20.80	2.32
3050.0	17.96	31.02	21.44	12.03	2.22	0.89	36.98	20.86	2.44
3100.0	17.77	31.06	21.45	11.75	2.27	0.88	36.93	20.78	2.40
3150.0	17.55	31.01	20.69	11.45	2.29	0.88	37.21	20.85	2.42
3200.0	17.32	30.87	20.01	11.10	2.30	0.88	37.00	20.85	2.42

Typical Performance Data

Definitions:

Input Return Loss = -S11 (dB)

Gain(Power Gain) = S21 (dB)

Reverse Isolation = -S12 (dB)

Output Return Loss = -S22 (dB)

TEST CONDITIONS: Vd = 4.75V, Id=121.67mA @ Temperature = +25degC

FREQ	Gain	Isolation	Input Return Loss	Output Return Loss	Stability		IP-3 Output	1dB Comp. Output	Noise Figure
					K	Measure			
(MHz)	(dB)	(dB)	(dB)	(dB)	K	Measure	(dBm)	(dBm)	(dB)
900.0	20.69	32.53	11.17	15.31	1.87	0.98	37.23	20.59	3.37
950.0	20.73	32.34	11.84	16.03	1.85	0.98	37.16	20.61	3.37
1000.0	20.72	32.01	12.33	16.79	1.81	0.97	36.93	20.64	3.34
1050.0	20.69	31.90	12.65	17.52	1.81	0.97	36.73	20.62	3.38
1100.0	20.65	31.62	12.76	18.19	1.77	0.97	36.98	20.59	3.33
1150.0	20.58	31.54	12.75	18.72	1.77	0.97	36.74	20.62	3.34
1200.0	20.52	31.44	12.63	19.24	1.76	0.97	36.58	20.52	3.30
1250.0	20.45	31.21	12.47	19.70	1.73	0.97	36.60	20.48	3.24
1300.0	20.39	31.19	12.31	20.27	1.74	0.98	36.68	20.52	3.25
1350.0	20.33	31.05	12.15	20.78	1.72	0.98	36.33	20.49	3.20
1400.0	20.28	31.01	11.98	21.10	1.72	0.98	36.17	20.50	3.18
1450.0	20.24	30.85	11.85	21.38	1.70	0.98	36.07	20.44	3.16
1500.0	20.19	30.86	11.73	21.65	1.71	0.99	36.02	20.35	3.08
1550.0	20.17	30.75	11.65	21.82	1.69	0.99	35.81	20.43	3.04
1600.0	20.15	30.71	11.56	22.07	1.69	0.99	35.69	20.40	3.02
1650.0	20.14	30.66	11.51	22.45	1.68	0.99	35.94	20.42	2.95
1700.0	20.15	30.58	11.48	22.69	1.67	0.99	35.86	20.52	2.91
1750.0	20.15	30.47	11.46	22.81	1.65	0.98	35.82	20.48	2.90
1800.0	20.17	30.45	11.48	22.73	1.64	0.98	35.59	20.48	2.83
1850.0	20.18	30.50	11.60	22.63	1.65	0.98	35.50	20.53	2.82
1900.0	20.20	30.43	11.64	22.76	1.64	0.98	35.67	20.53	2.82
1950.0	20.23	30.36	11.75	22.77	1.63	0.97	35.49	20.53	2.83
2000.0	20.25	30.40	11.88	22.75	1.64	0.97	35.49	20.58	2.74
2050.0	20.28	30.38	12.03	22.53	1.63	0.97	35.58	20.54	2.68
2100.0	20.29	30.50	12.27	22.23	1.66	0.97	35.12	20.53	2.68
2150.0	20.30	30.33	12.49	21.96	1.64	0.96	35.14	20.57	2.61
2200.0	20.30	30.37	12.77	21.52	1.65	0.95	35.46	20.58	2.61
2250.0	20.27	30.53	13.22	20.97	1.69	0.95	35.30	20.60	2.55
2300.0	20.21	30.49	13.62	20.62	1.70	0.94	35.43	20.62	2.56
2350.0	20.16	30.54	14.05	19.90	1.72	0.94	35.31	20.61	2.47
2400.0	20.10	30.63	14.45	19.28	1.75	0.93	35.38	20.63	2.47
2450.0	20.02	30.72	14.88	18.53	1.78	0.93	35.47	20.64	2.47
2500.0	19.94	30.64	15.38	17.81	1.79	0.92	35.45	20.63	2.45
2550.0	19.82	30.69	16.04	17.08	1.82	0.92	35.60	20.58	2.43
2600.0	19.69	30.81	16.77	16.40	1.87	0.91	35.63	20.59	2.41
2650.0	19.55	30.73	17.44	15.61	1.88	0.91	35.82	20.55	2.37
2700.0	19.40	30.87	18.12	15.02	1.93	0.90	35.94	20.49	2.42
2750.0	19.22	30.77	18.99	14.42	1.95	0.90	36.01	20.57	2.40
2800.0	19.05	30.91	19.67	13.95	2.00	0.90	36.12	20.51	2.32
2850.0	18.87	30.84	20.43	13.48	2.02	0.89	35.83	20.47	2.36
2900.0	18.67	30.93	21.05	13.00	2.07	0.89	35.96	20.45	2.38
2950.0	18.46	30.94	21.73	12.53	2.11	0.89	36.46	20.42	2.37
3000.0	18.26	30.83	21.69	12.12	2.12	0.88	36.62	20.44	2.34
3050.0	18.02	30.81	21.73	11.71	2.15	0.88	36.56	20.50	2.40
3100.0	17.83	30.86	21.81	11.43	2.20	0.88	36.66	20.41	2.38
3150.0	17.60	30.86	21.11	11.13	2.24	0.87	36.92	20.49	2.40
3200.0	17.37	30.86	20.43	10.80	2.27	0.87	36.55	20.49	2.41

Typical Performance Data

Definitions:

Input Return Loss = -S11 (dB)

Gain(Power Gain) = S21 (dB)

Reverse Isolation = -S12 (dB)

Output Return Loss = -S22 (dB)

TEST CONDITIONS: Vd = 5.25V, Id=122.70mA @ Temperature = +25degC

FREQ	Gain	Isolation	Input Return Loss	Output Return Loss	Stability		IP-3 Output	1dB Comp. Output	Noise Figure
					K	Measure			
(MHz)	(dB)	(dB)	(dB)	(dB)	K	Measure	(dBm)	(dBm)	(dB)
900.0	20.63	32.63	11.09	15.19	1.89	0.99	37.61	21.13	3.43
950.0	20.67	32.28	11.74	15.89	1.85	0.98	37.55	21.16	3.34
1000.0	20.67	32.21	12.20	16.58	1.85	0.98	37.51	21.19	3.40
1050.0	20.64	31.95	12.54	17.24	1.82	0.97	36.93	21.16	3.36
1100.0	20.59	31.82	12.66	17.87	1.81	0.97	36.97	21.14	3.33
1150.0	20.54	31.53	12.64	18.37	1.77	0.97	37.16	21.16	3.31
1200.0	20.47	31.53	12.54	18.83	1.78	0.98	37.25	21.08	3.33
1250.0	20.41	31.36	12.37	19.23	1.76	0.98	36.86	21.05	3.28
1300.0	20.34	31.25	12.22	19.70	1.75	0.98	37.08	21.09	3.28
1350.0	20.28	31.23	12.06	20.13	1.76	0.98	36.76	21.06	3.22
1400.0	20.24	31.09	11.90	20.48	1.74	0.99	36.89	21.08	3.19
1450.0	20.19	31.05	11.77	20.67	1.73	0.99	36.77	21.01	3.14
1500.0	20.15	30.93	11.64	20.95	1.72	0.99	36.62	20.92	3.13
1550.0	20.12	30.84	11.54	21.15	1.71	0.99	36.34	20.97	3.05
1600.0	20.10	30.82	11.47	21.38	1.70	0.99	36.46	20.96	3.04
1650.0	20.10	30.74	11.41	21.74	1.69	0.99	36.53	20.99	2.97
1700.0	20.10	30.73	11.41	22.00	1.69	0.99	36.16	21.05	2.94
1750.0	20.10	30.61	11.40	22.21	1.67	0.99	36.22	21.03	2.93
1800.0	20.12	30.61	11.41	22.29	1.67	0.99	36.06	21.03	2.82
1850.0	20.13	30.67	11.52	22.32	1.68	0.99	36.16	21.07	2.82
1900.0	20.15	30.57	11.54	22.57	1.67	0.98	36.05	21.07	2.78
1950.0	20.17	30.70	11.67	22.75	1.69	0.98	35.92	21.08	2.90
2000.0	20.20	30.48	11.80	22.86	1.65	0.98	35.98	21.12	2.74
2050.0	20.21	30.48	11.99	22.87	1.66	0.97	35.74	21.08	2.67
2100.0	20.22	30.56	12.21	22.87	1.67	0.97	35.74	21.07	2.68
2150.0	20.22	30.59	12.44	22.82	1.69	0.97	35.49	21.10	2.58
2200.0	20.22	30.56	12.74	22.53	1.69	0.96	35.56	21.12	2.60
2250.0	20.19	30.70	13.15	22.25	1.73	0.96	35.66	21.13	2.55
2300.0	20.12	30.74	13.62	22.01	1.76	0.95	35.64	21.16	2.58
2350.0	20.07	30.77	14.02	21.37	1.78	0.95	35.57	21.15	2.51
2400.0	20.02	30.78	14.38	20.72	1.79	0.94	35.72	21.17	2.46
2450.0	19.93	30.75	14.86	19.86	1.81	0.94	35.68	21.16	2.49
2500.0	19.84	30.83	15.39	19.06	1.85	0.93	35.61	21.18	2.50
2550.0	19.72	31.02	16.12	18.25	1.91	0.93	35.67	21.13	2.45
2600.0	19.59	30.98	16.83	17.43	1.93	0.92	35.95	21.16	2.42
2650.0	19.45	31.10	17.49	16.62	1.98	0.92	35.67	21.13	2.38
2700.0	19.30	31.03	18.21	15.95	2.00	0.92	36.20	21.09	2.43
2750.0	19.13	30.99	18.93	15.29	2.02	0.91	36.22	21.15	2.41
2800.0	18.96	31.11	19.56	14.75	2.08	0.91	36.39	21.11	2.35
2850.0	18.76	31.03	20.22	14.24	2.10	0.90	36.38	21.10	2.37
2900.0	18.58	31.14	20.82	13.73	2.15	0.90	36.16	21.11	2.42
2950.0	18.36	31.16	21.32	13.22	2.20	0.90	36.64	21.11	2.40
3000.0	18.16	31.03	21.25	12.75	2.20	0.89	36.93	21.13	2.33
3050.0	17.92	31.06	21.32	12.30	2.25	0.89	37.05	21.19	2.42
3100.0	17.73	31.10	21.00	12.01	2.29	0.89	37.03	21.13	2.38
3150.0	17.51	31.02	20.23	11.72	2.31	0.89	37.32	21.18	2.40
3200.0	17.27	30.97	19.70	11.35	2.34	0.89	36.84	21.17	2.45

Typical Performance Data

Definitions:

Input Return Loss = -S11 (dB)

Gain(Power Gain) = S21 (dB)

Reverse Isolation = -S12 (dB)

Output Return Loss = -S22 (dB)

TEST CONDITIONS: Vd = 5.00V, Id=120.34mA @ Temperature = -45degC

FREQ	Gain	Isolation	Input Return Loss	Output Return Loss	Stability		IP-3 Output	1dB Comp. Output	Noise Figure
					K	Measure			
(MHz)	(dB)	(dB)	(dB)	(dB)	K	Measure	(dBm)	(dBm)	(dB)
900.0	21.11	32.74	11.16	14.97	1.82	0.98	37.97	20.96	2.84
950.0	21.16	32.42	11.91	15.69	1.79	0.97	38.15	21.00	2.75
1000.0	21.17	32.31	12.44	16.37	1.78	0.97	38.35	21.03	2.80
1050.0	21.15	32.14	12.86	16.97	1.77	0.96	38.24	21.01	2.77
1100.0	21.11	31.82	13.06	17.57	1.73	0.96	38.34	20.98	2.78
1150.0	21.06	31.68	13.11	18.07	1.72	0.96	38.23	21.00	2.79
1200.0	21.01	31.55	13.05	18.65	1.70	0.96	38.44	20.91	2.74
1250.0	20.95	31.47	12.88	19.08	1.70	0.96	38.68	20.87	2.72
1300.0	20.90	31.41	12.77	19.53	1.70	0.97	38.57	20.90	2.71
1350.0	20.84	31.15	12.59	19.83	1.66	0.97	38.50	20.88	2.64
1400.0	20.79	31.08	12.41	20.09	1.65	0.97	38.29	20.90	2.63
1450.0	20.77	31.11	12.34	20.40	1.66	0.97	38.12	20.85	2.61
1500.0	20.73	30.96	12.19	20.63	1.64	0.97	38.20	20.73	2.57
1550.0	20.71	30.94	12.10	20.86	1.64	0.97	38.08	20.79	2.49
1600.0	20.70	30.80	11.99	21.12	1.62	0.97	37.78	20.77	2.47
1650.0	20.69	30.76	11.91	21.44	1.62	0.97	38.04	20.80	2.41
1700.0	20.70	30.73	11.88	21.60	1.61	0.97	37.79	20.88	2.36
1750.0	20.72	30.64	11.84	21.81	1.59	0.97	37.72	20.87	2.41
1800.0	20.73	30.69	11.91	21.88	1.60	0.97	37.75	20.87	2.27
1850.0	20.76	30.56	12.01	21.91	1.58	0.96	37.78	20.93	2.28
1900.0	20.79	30.50	12.05	22.08	1.57	0.96	37.26	20.91	2.26
1950.0	20.83	30.52	12.12	22.19	1.57	0.96	37.47	20.92	2.27
2000.0	20.86	30.46	12.20	22.25	1.56	0.96	37.17	20.98	2.22
2050.0	20.89	30.50	12.42	22.35	1.57	0.95	36.99	20.95	2.13
2100.0	20.91	30.56	12.58	22.26	1.58	0.95	36.56	20.95	2.15
2150.0	20.95	30.52	12.80	21.90	1.57	0.94	36.99	20.98	2.08
2200.0	20.95	30.56	13.14	22.00	1.58	0.94	36.66	20.99	2.06
2250.0	20.98	30.42	13.39	21.42	1.56	0.93	36.71	21.00	2.04
2300.0	20.87	30.63	14.01	21.45	1.62	0.93	36.75	21.02	2.00
2350.0	20.84	30.62	14.33	21.05	1.63	0.93	36.70	21.03	1.95
2400.0	20.81	30.64	14.55	20.30	1.64	0.92	36.47	21.04	1.97
2450.0	20.76	30.46	14.90	19.57	1.62	0.91	36.66	21.03	1.99
2500.0	20.65	30.68	15.62	18.65	1.68	0.91	36.54	21.03	1.95
2550.0	20.52	30.90	16.54	17.97	1.74	0.91	36.43	20.98	1.91
2600.0	20.43	30.82	17.03	17.36	1.75	0.91	36.34	21.00	1.86
2650.0	20.28	30.90	18.00	16.41	1.79	0.90	36.30	20.98	1.87
2700.0	20.14	30.84	18.68	16.03	1.80	0.90	36.54	20.95	1.89
2750.0	19.99	30.88	19.33	15.35	1.83	0.89	36.50	20.98	1.89
2800.0	19.82	30.83	20.09	14.68	1.85	0.89	36.44	20.92	1.82
2850.0	19.67	30.88	20.92	14.32	1.89	0.89	36.39	20.92	1.88
2900.0	19.48	30.80	21.93	13.67	1.90	0.88	36.47	20.92	1.87
2950.0	19.30	30.79	22.34	13.22	1.92	0.88	36.46	20.92	1.87
3000.0	19.03	30.84	23.55	12.53	1.97	0.87	36.54	20.91	1.83
3050.0	18.85	30.76	23.68	12.27	1.99	0.87	36.69	20.97	1.85
3100.0	18.54	30.86	24.88	11.56	2.05	0.87	37.01	20.91	1.80
3150.0	18.41	30.76	23.65	11.44	2.05	0.87	37.11	20.96	1.86
3200.0	18.21	30.59	22.86	11.18	2.05	0.86	36.56	20.95	1.86

Typical Performance Data

Definitions:

Input Return Loss = -S11 (dB)

Gain(Power Gain) = S21 (dB)

Reverse Isolation = -S12 (dB)

Output Return Loss = -S22 (dB)

TEST CONDITIONS: Vd = 4.75V, Id=120.40mA @ Temperature = -45degC

FREQ	Gain	Isolation	Input Return Loss	Output Return Loss	Stability		IP-3 Output	1dB Comp. Output	Noise Figure
(MHz)	(dB)	(dB)	(dB)	(dB)	K	Measure	(dBm)	(dBm)	(dB)
900.0	21.09	32.84	11.16	15.01	1.85	0.98	38.52	20.68	2.84
950.0	21.14	32.53	11.90	15.77	1.81	0.97	38.47	20.72	2.80
1000.0	21.15	32.28	12.44	16.42	1.78	0.97	38.46	20.74	2.81
1050.0	21.13	32.08	12.83	17.04	1.76	0.96	38.32	20.73	2.78
1100.0	21.09	31.83	13.04	17.65	1.73	0.96	38.34	20.70	2.79
1150.0	21.03	31.68	13.10	18.20	1.72	0.96	38.17	20.72	2.77
1200.0	20.99	31.49	13.04	18.76	1.70	0.96	38.56	20.62	2.77
1250.0	20.92	31.42	12.86	19.22	1.69	0.96	38.77	20.58	2.70
1300.0	20.87	31.35	12.74	19.65	1.69	0.97	39.30	20.61	2.69
1350.0	20.81	31.17	12.56	19.97	1.67	0.97	38.57	20.59	2.64
1400.0	20.77	31.04	12.38	20.27	1.65	0.97	38.09	20.61	2.61
1450.0	20.74	31.16	12.31	20.57	1.68	0.97	38.38	20.56	2.63
1500.0	20.70	30.98	12.17	20.77	1.65	0.97	38.53	20.45	2.57
1550.0	20.68	30.89	12.09	21.07	1.64	0.97	38.51	20.52	2.51
1600.0	20.67	30.85	11.98	21.31	1.63	0.97	38.03	20.49	2.48
1650.0	20.66	30.77	11.87	21.61	1.62	0.97	38.24	20.52	2.43
1700.0	20.67	30.75	11.84	21.77	1.62	0.97	37.91	20.62	2.38
1750.0	20.69	30.57	11.82	22.01	1.59	0.97	37.76	20.59	2.38
1800.0	20.71	30.57	11.88	22.06	1.59	0.97	37.45	20.59	2.28
1850.0	20.73	30.49	11.97	22.04	1.57	0.96	37.51	20.65	2.27
1900.0	20.76	30.48	12.02	22.20	1.57	0.96	37.76	20.64	2.26
1950.0	20.80	30.47	12.08	22.30	1.57	0.96	37.36	20.65	2.26
2000.0	20.84	30.46	12.16	22.39	1.56	0.96	37.11	20.72	2.18
2050.0	20.86	30.62	12.39	22.40	1.59	0.96	37.07	20.68	2.13
2100.0	20.89	30.37	12.51	22.32	1.55	0.95	36.78	20.67	2.14
2150.0	20.93	30.29	12.74	21.87	1.54	0.94	36.58	20.71	2.08
2200.0	20.92	30.53	13.08	21.87	1.58	0.94	36.73	20.71	2.09
2250.0	20.96	30.27	13.30	21.29	1.54	0.93	36.80	20.73	2.04
2300.0	20.86	30.60	13.91	21.35	1.62	0.93	36.71	20.75	2.01
2350.0	20.83	30.63	14.24	20.86	1.63	0.93	36.15	20.76	1.98
2400.0	20.80	30.48	14.46	20.06	1.62	0.92	36.19	20.77	1.95
2450.0	20.75	30.51	14.74	19.37	1.63	0.92	36.50	20.76	1.97
2500.0	20.65	30.61	15.50	18.47	1.67	0.91	36.07	20.76	1.95
2550.0	20.51	30.80	16.35	17.79	1.73	0.91	36.29	20.71	1.92
2600.0	20.42	30.60	16.85	17.19	1.71	0.90	36.01	20.72	1.88
2650.0	20.28	30.82	17.81	16.23	1.77	0.90	36.13	20.70	1.86
2700.0	20.14	30.88	18.43	15.85	1.81	0.90	36.21	20.65	1.92
2750.0	19.99	30.80	19.06	15.21	1.82	0.89	36.19	20.69	1.88
2800.0	19.82	30.77	19.86	14.56	1.84	0.89	36.11	20.62	1.82
2850.0	19.67	30.78	20.70	14.19	1.86	0.89	36.15	20.61	1.88
2900.0	19.48	30.87	21.62	13.56	1.91	0.88	36.12	20.59	1.88
2950.0	19.31	30.75	22.11	13.10	1.91	0.88	36.02	20.58	1.86
3000.0	19.03	30.81	23.44	12.41	1.96	0.87	36.00	20.56	1.83
3050.0	18.87	30.69	23.64	12.16	1.97	0.87	36.18	20.60	1.86
3100.0	18.54	30.93	25.13	11.48	2.06	0.87	36.46	20.52	1.83
3150.0	18.43	30.68	23.89	11.35	2.03	0.86	36.47	20.60	1.85
3200.0	18.22	30.60	23.19	11.10	2.04	0.86	35.98	20.59	1.85

Typical Performance Data

Definitions:

Input Return Loss = -S11 (dB)

Gain(Power Gain) = S21 (dB)

Reverse Isolation = -S12 (dB)

Output Return Loss = -S22 (dB)

TEST CONDITIONS: Vd = 5.25V, Id=120.94mA @ Temperature = -45degC

FREQ	Gain	Isolation	Input Return Loss	Output Return Loss	Stability		IP-3 Output	1dB Comp. Output	Noise Figure
					K	Measure			
(MHz)	(dB)	(dB)	(dB)	(dB)	K	Measure	(dBm)	(dBm)	(dB)
900.0	21.13	32.77	11.17	14.93	1.83	0.98	38.19	21.22	2.85
950.0	21.17	32.44	11.91	15.66	1.79	0.97	37.98	21.26	2.74
1000.0	21.19	32.33	12.46	16.31	1.78	0.97	38.60	21.29	2.82
1050.0	21.16	32.12	12.86	16.94	1.76	0.96	38.14	21.27	2.79
1100.0	21.13	31.98	13.06	17.50	1.75	0.96	38.24	21.24	2.77
1150.0	21.07	31.68	13.13	18.00	1.71	0.96	38.36	21.26	2.76
1200.0	21.03	31.55	13.05	18.55	1.70	0.96	38.51	21.17	2.77
1250.0	20.97	31.53	12.88	18.98	1.70	0.96	38.23	21.14	2.73
1300.0	20.91	31.32	12.76	19.40	1.68	0.96	38.40	21.17	2.70
1350.0	20.86	31.28	12.58	19.70	1.68	0.97	38.37	21.15	2.64
1400.0	20.81	31.05	12.43	19.93	1.65	0.97	38.16	21.17	2.62
1450.0	20.79	31.16	12.35	20.27	1.67	0.97	37.96	21.12	2.60
1500.0	20.75	30.99	12.20	20.45	1.64	0.97	38.18	21.00	2.56
1550.0	20.73	30.91	12.11	20.72	1.64	0.97	37.80	21.05	2.49
1600.0	20.71	30.80	12.01	20.95	1.62	0.97	37.67	21.04	2.49
1650.0	20.71	30.85	11.91	21.28	1.63	0.97	37.77	21.07	2.40
1700.0	20.72	30.78	11.87	21.47	1.61	0.97	37.88	21.13	2.37
1750.0	20.74	30.73	11.86	21.61	1.60	0.97	37.47	21.12	2.40
1800.0	20.75	30.71	11.93	21.75	1.60	0.97	37.41	21.13	2.26
1850.0	20.78	30.63	12.01	21.74	1.59	0.97	37.44	21.18	2.27
1900.0	20.81	30.54	12.06	21.95	1.57	0.96	37.44	21.17	2.27
1950.0	20.85	30.53	12.14	22.13	1.57	0.96	37.47	21.18	2.25
2000.0	20.88	30.48	12.22	22.18	1.56	0.96	37.09	21.24	2.19
2050.0	20.90	30.57	12.47	22.30	1.58	0.95	37.05	21.20	2.15
2100.0	20.93	30.57	12.58	22.24	1.57	0.95	36.97	21.20	2.13
2150.0	20.96	30.55	12.81	21.96	1.57	0.95	36.62	21.23	2.08
2200.0	20.96	30.55	13.18	22.06	1.58	0.94	36.63	21.24	2.10
2250.0	20.99	30.40	13.44	21.45	1.56	0.93	36.69	21.25	2.01
2300.0	20.88	30.70	14.08	21.65	1.63	0.93	36.74	21.27	2.03
2350.0	20.85	30.70	14.38	21.16	1.64	0.93	36.35	21.29	1.98
2400.0	20.82	30.66	14.63	20.41	1.64	0.92	36.51	21.29	1.93
2450.0	20.77	30.63	14.93	19.78	1.65	0.92	36.64	21.28	1.97
2500.0	20.66	30.72	15.72	18.83	1.69	0.91	36.35	21.29	1.95
2550.0	20.52	30.79	16.67	18.12	1.73	0.91	36.52	21.25	1.90
2600.0	20.43	30.77	17.18	17.52	1.74	0.91	36.60	21.26	1.87
2650.0	20.28	30.90	18.11	16.53	1.79	0.90	36.73	21.25	1.85
2700.0	20.14	31.02	18.78	16.16	1.84	0.90	36.88	21.23	1.91
2750.0	19.99	30.88	19.45	15.52	1.84	0.90	36.80	21.26	1.89
2800.0	19.82	30.90	20.22	14.83	1.87	0.89	37.00	21.21	1.83
2850.0	19.66	30.89	21.15	14.42	1.89	0.89	36.71	21.22	1.87
2900.0	19.47	31.00	22.07	13.78	1.94	0.89	36.78	21.23	1.83
2950.0	19.29	30.82	22.44	13.33	1.93	0.88	36.62	21.25	1.88
3000.0	19.02	30.91	23.40	12.64	1.99	0.88	36.94	21.25	1.82
3050.0	18.84	30.77	23.58	12.36	1.99	0.87	37.12	21.31	1.81
3100.0	18.52	31.04	24.44	11.65	2.09	0.87	37.25	21.26	1.81
3150.0	18.40	30.81	23.44	11.52	2.06	0.87	37.31	21.30	1.87
3200.0	18.20	30.65	22.56	11.29	2.06	0.87	36.94	21.29	1.83

Typical Performance Data

Definitions:

Input Return Loss = -S11 (dB)

Gain(Power Gain) = S21 (dB)

Reverse Isolation = -S12 (dB)

Output Return Loss = -S22 (dB)

TEST CONDITIONS: Vd = 5.00V, Id=121.83mA @ Temperature = +85degC

FREQ	Gain	Isolation	Input Return Loss	Output Return Loss	Stability		IP-3 Output	1dB Comp. Output	Noise Figure
					K	Measure			
(MHz)	(dB)	(dB)	(dB)	(dB)	K	Measure	(dBm)	(dBm)	(dB)
900.0	20.18	32.41	10.83	15.30	1.93	1.00	37.10	20.70	3.96
950.0	20.21	32.26	11.40	15.97	1.92	0.99	37.02	20.73	3.92
1000.0	20.20	31.98	11.82	16.68	1.88	0.99	36.85	20.75	3.96
1050.0	20.16	31.70	12.10	17.45	1.85	0.98	36.81	20.73	3.94
1100.0	20.11	31.65	12.18	18.15	1.86	0.99	36.56	20.71	3.91
1150.0	20.04	31.48	12.11	18.76	1.84	0.99	36.71	20.73	3.88
1200.0	19.97	31.32	11.97	19.21	1.82	0.99	36.51	20.65	3.89
1250.0	19.89	31.15	11.75	19.61	1.80	0.99	36.41	20.61	3.85
1300.0	19.82	31.19	11.59	20.01	1.82	1.00	36.42	20.65	3.83
1350.0	19.75	31.02	11.44	20.45	1.80	1.00	36.34	20.62	3.75
1400.0	19.69	30.92	11.29	20.80	1.78	1.00	36.10	20.63	3.73
1450.0	19.65	30.92	11.19	21.07	1.79	1.01	35.89	20.56	3.74
1500.0	19.60	30.81	11.08	21.32	1.78	1.01	35.86	20.49	3.67
1550.0	19.56	30.74	10.97	21.47	1.77	1.01	35.82	20.56	3.63
1600.0	19.54	30.68	10.89	21.73	1.76	1.01	35.55	20.53	3.58
1650.0	19.52	30.63	10.85	22.16	1.75	1.01	35.78	20.56	3.53
1700.0	19.52	30.53	10.85	22.50	1.74	1.01	35.64	20.63	3.49
1750.0	19.52	30.55	10.87	22.83	1.75	1.01	35.34	20.60	3.46
1800.0	19.52	30.54	10.93	23.11	1.75	1.01	35.43	20.59	3.36
1850.0	19.53	30.47	11.00	23.10	1.74	1.00	35.37	20.63	3.38
1900.0	19.54	30.51	11.06	23.38	1.75	1.00	35.45	20.64	3.35
1950.0	19.56	30.39	11.18	23.50	1.73	1.00	35.29	20.64	3.37
2000.0	19.57	30.36	11.33	23.71	1.72	0.99	35.03	20.68	3.31
2050.0	19.59	30.51	11.57	23.52	1.75	0.99	35.08	20.63	3.22
2100.0	19.59	30.48	11.78	23.81	1.76	0.99	34.99	20.62	3.23
2150.0	19.59	30.56	12.04	23.34	1.78	0.98	35.11	20.65	3.16
2200.0	19.56	30.51	12.29	23.40	1.79	0.98	34.97	20.66	3.18
2250.0	19.54	30.70	12.70	22.51	1.83	0.97	35.18	20.67	3.12
2300.0	19.44	30.74	13.35	22.09	1.88	0.97	35.14	20.70	3.12
2350.0	19.38	31.01	13.72	21.27	1.94	0.97	35.04	20.66	3.04
2400.0	19.32	30.75	14.10	20.45	1.91	0.96	35.07	20.69	3.05
2450.0	19.24	30.59	14.49	19.73	1.90	0.95	35.29	20.71	3.09
2500.0	19.13	30.98	15.12	18.74	2.01	0.95	35.30	20.71	3.04
2550.0	18.99	31.03	15.83	17.82	2.05	0.94	35.18	20.66	2.98
2600.0	18.86	31.13	16.47	17.03	2.10	0.94	35.29	20.69	2.98
2650.0	18.72	31.29	17.16	16.20	2.17	0.93	35.41	20.64	2.97
2700.0	18.56	31.14	17.85	15.56	2.17	0.93	35.62	20.59	3.01
2750.0	18.39	31.15	18.40	14.98	2.21	0.92	35.78	20.68	3.02
2800.0	18.22	31.09	18.67	14.36	2.23	0.92	35.81	20.64	2.96
2850.0	18.05	31.27	19.47	14.09	2.31	0.92	35.82	20.61	2.98
2900.0	17.85	31.32	19.67	13.55	2.36	0.91	35.89	20.62	2.99
2950.0	17.66	31.20	19.82	13.13	2.36	0.91	35.92	20.60	2.98
3000.0	17.45	31.23	19.46	12.70	2.41	0.91	36.52	20.65	2.97
3050.0	17.23	31.09	19.24	12.42	2.42	0.90	36.43	20.70	2.95
3100.0	16.92	31.40	18.65	11.84	2.56	0.90	36.69	20.62	2.98
3150.0	16.81	31.33	18.50	11.80	2.56	0.90	36.72	20.70	3.02
3200.0	16.62	31.24	17.82	11.57	2.58	0.90	36.30	20.71	3.02

Typical Performance Data

Definitions:

Input Return Loss = -S11 (dB)

Gain(Power Gain) = S21 (dB)

Reverse Isolation = -S12 (dB)

Output Return Loss = -S22 (dB)

TEST CONDITIONS: Vd = 4.75V, Id=120.86mA @ Temperature = +85degC

FREQ	Gain	Isolation	Input Return Loss	Output Return Loss	Stability		IP-3 Output	1dB Comp. Output	Noise Figure
					K	Measure			
(MHz)	(dB)	(dB)	(dB)	(dB)	K	Measure	(dBm)	(dBm)	(dB)
900.0	20.21	32.42	10.91	15.38	1.94	0.99	36.71	20.41	3.94
950.0	20.23	32.11	11.47	16.07	1.89	0.99	36.69	20.44	3.91
1000.0	20.22	31.87	11.89	16.82	1.87	0.98	36.42	20.46	3.93
1050.0	20.18	31.70	12.16	17.62	1.85	0.98	36.16	20.44	3.87
1100.0	20.13	31.55	12.23	18.37	1.84	0.98	36.14	20.42	3.86
1150.0	20.05	31.38	12.17	19.01	1.82	0.98	36.01	20.44	3.88
1200.0	19.98	31.15	12.02	19.50	1.79	0.99	35.95	20.35	3.85
1250.0	19.90	31.18	11.78	19.91	1.81	0.99	35.86	20.31	3.79
1300.0	19.83	31.05	11.63	20.39	1.80	1.00	36.01	20.35	3.81
1350.0	19.75	30.95	11.46	20.88	1.79	1.00	35.60	20.32	3.70
1400.0	19.70	30.89	11.32	21.25	1.78	1.00	35.45	20.32	3.71
1450.0	19.66	30.79	11.22	21.59	1.77	1.00	35.29	20.25	3.67
1500.0	19.60	30.70	11.11	21.81	1.76	1.00	35.34	20.18	3.65
1550.0	19.57	30.66	11.01	22.02	1.76	1.01	35.28	20.27	3.57
1600.0	19.54	30.65	10.93	22.27	1.76	1.01	35.13	20.23	3.55
1650.0	19.53	30.51	10.87	22.66	1.74	1.01	35.17	20.26	3.48
1700.0	19.53	30.46	10.87	22.99	1.73	1.01	35.14	20.34	3.44
1750.0	19.53	30.46	10.88	23.23	1.73	1.01	34.88	20.30	3.42
1800.0	19.53	30.40	10.95	23.45	1.72	1.00	34.82	20.29	3.31
1850.0	19.53	30.26	11.03	23.38	1.70	1.00	34.83	20.33	3.36
1900.0	19.55	30.35	11.09	23.48	1.72	1.00	34.83	20.34	3.31
1950.0	19.57	30.31	11.20	23.51	1.71	1.00	34.89	20.34	3.31
2000.0	19.59	30.29	11.35	23.54	1.71	0.99	34.61	20.38	3.24
2050.0	19.61	30.36	11.58	23.11	1.73	0.99	34.55	20.33	3.21
2100.0	19.60	30.26	11.80	23.19	1.72	0.98	34.68	20.32	3.15
2150.0	19.60	30.40	12.05	22.57	1.75	0.98	34.60	20.36	3.13
2200.0	19.58	30.25	12.29	22.43	1.74	0.97	34.68	20.36	3.13
2250.0	19.56	30.59	12.70	21.42	1.81	0.97	34.72	20.38	3.07
2300.0	19.46	30.65	13.32	20.89	1.85	0.96	34.75	20.39	3.09
2350.0	19.41	30.72	13.72	20.12	1.88	0.96	34.63	20.35	3.02
2400.0	19.35	30.64	14.08	19.41	1.88	0.95	34.70	20.39	2.99
2450.0	19.27	30.68	14.46	18.66	1.91	0.95	34.88	20.42	3.07
2500.0	19.16	30.75	15.07	17.80	1.95	0.94	34.89	20.40	2.98
2550.0	19.02	30.94	15.81	16.96	2.02	0.94	34.82	20.35	2.97
2600.0	18.89	30.96	16.47	16.23	2.05	0.93	35.04	20.37	2.95
2650.0	18.75	30.99	17.12	15.46	2.09	0.92	35.07	20.31	2.90
2700.0	18.60	30.86	17.81	14.91	2.09	0.92	35.48	20.24	2.99
2750.0	18.43	31.04	18.43	14.34	2.16	0.91	35.53	20.36	2.97
2800.0	18.26	31.03	18.75	13.77	2.19	0.91	35.66	20.30	2.90
2850.0	18.08	30.95	19.56	13.51	2.21	0.90	35.53	20.26	2.92
2900.0	17.89	31.15	19.81	12.99	2.30	0.90	35.45	20.25	2.96
2950.0	17.69	31.08	20.01	12.61	2.32	0.90	35.77	20.21	2.98
3000.0	17.49	31.02	19.66	12.21	2.34	0.90	35.99	20.27	2.92
3050.0	17.27	31.00	19.52	11.93	2.38	0.89	36.33	20.32	2.94
3100.0	16.95	31.19	18.89	11.40	2.48	0.89	36.32	20.22	2.96
3150.0	16.84	31.14	18.80	11.35	2.49	0.89	36.54	20.33	2.93
3200.0	16.65	30.88	18.12	11.15	2.46	0.89	36.01	20.33	2.94

Typical Performance Data

Definitions:

Input Return Loss = -S11 (dB)

Gain(Power Gain) = S21 (dB)

Reverse Isolation = -S12 (dB)

Output Return Loss = -S22 (dB)

TEST CONDITIONS: Vd = 5.25V, Id=122.63mA @ Temperature = +85degC

FREQ	Gain	Isolation	Input Return Loss	Output Return Loss	Stability		IP-3 Output	1dB Comp. Output	Noise Figure
					K	Measure			
(MHz)	(dB)	(dB)	(dB)	(dB)	K	Measure	(dBm)	(dBm)	(dB)
900.0	20.17	32.37	10.79	15.25	1.92	1.00	37.40	20.98	4.03
950.0	20.20	32.16	11.36	15.91	1.90	0.99	36.96	21.02	3.95
1000.0	20.19	32.03	11.77	16.59	1.89	0.99	37.37	21.04	3.96
1050.0	20.16	31.77	12.08	17.32	1.86	0.99	37.02	21.02	3.94
1100.0	20.11	31.61	12.15	18.01	1.85	0.99	36.74	20.99	3.95
1150.0	20.03	31.43	12.08	18.60	1.83	0.99	36.86	21.02	3.90
1200.0	19.97	31.32	11.94	19.01	1.82	0.99	36.88	20.94	3.94
1250.0	19.89	31.29	11.72	19.35	1.82	1.00	36.65	20.91	3.87
1300.0	19.81	31.29	11.56	19.74	1.83	1.00	36.67	20.95	3.88
1350.0	19.75	31.07	11.41	20.14	1.80	1.00	36.58	20.92	3.77
1400.0	19.69	30.98	11.27	20.49	1.79	1.00	36.42	20.93	3.78
1450.0	19.65	30.92	11.18	20.76	1.79	1.01	36.28	20.85	3.77
1500.0	19.60	30.89	11.06	20.96	1.79	1.01	35.94	20.78	3.72
1550.0	19.56	30.75	10.96	21.14	1.77	1.01	35.98	20.85	3.64
1600.0	19.54	30.73	10.87	21.37	1.77	1.01	36.19	20.82	3.64
1650.0	19.52	30.64	10.82	21.75	1.75	1.01	35.92	20.86	3.53
1700.0	19.52	30.68	10.84	22.09	1.76	1.01	35.86	20.92	3.51
1750.0	19.52	30.52	10.86	22.48	1.74	1.01	35.62	20.89	3.51
1800.0	19.52	30.62	10.92	22.75	1.76	1.01	35.58	20.89	3.41
1850.0	19.52	30.58	11.00	22.83	1.76	1.01	35.47	20.92	3.42
1900.0	19.53	30.52	11.05	23.13	1.75	1.00	35.42	20.93	3.40
1950.0	19.55	30.53	11.18	23.41	1.75	1.00	35.55	20.93	3.40
2000.0	19.57	30.49	11.32	23.68	1.75	1.00	35.29	20.96	3.32
2050.0	19.58	30.63	11.60	23.68	1.78	0.99	35.41	20.91	3.24
2100.0	19.58	30.57	11.79	24.02	1.78	0.99	35.14	20.90	3.25
2150.0	19.57	30.74	12.02	23.81	1.81	0.99	35.57	20.94	3.20
2200.0	19.55	30.57	12.26	23.89	1.80	0.98	35.43	20.95	3.21
2250.0	19.52	30.76	12.69	23.29	1.85	0.98	35.16	20.96	3.15
2300.0	19.42	30.96	13.37	22.85	1.92	0.97	35.22	20.99	3.11
2350.0	19.37	30.92	13.72	22.13	1.93	0.97	35.35	20.97	3.06
2400.0	19.31	30.95	14.11	21.26	1.96	0.96	35.32	20.99	3.06
2450.0	19.22	30.96	14.52	20.39	1.98	0.96	35.31	21.00	3.16
2500.0	19.11	30.92	15.10	19.46	2.00	0.95	35.17	21.01	3.05
2550.0	18.97	31.12	15.84	18.43	2.08	0.95	35.37	20.96	3.03
2600.0	18.84	31.21	16.49	17.58	2.13	0.94	35.55	20.99	3.00
2650.0	18.70	31.28	17.09	16.70	2.18	0.94	35.50	20.96	3.00
2700.0	18.54	31.32	17.77	16.04	2.22	0.93	35.75	20.91	3.05
2750.0	18.37	31.38	18.38	15.43	2.27	0.93	36.03	20.99	3.02
2800.0	18.20	31.37	18.61	14.78	2.30	0.92	35.88	20.96	2.97
2850.0	18.03	31.45	19.35	14.50	2.36	0.92	35.79	20.94	3.02
2900.0	17.83	31.40	19.53	13.92	2.39	0.92	35.98	20.97	3.02
2950.0	17.64	31.50	19.60	13.50	2.45	0.92	36.41	20.96	3.04
3000.0	17.43	31.42	19.24	13.02	2.47	0.91	36.35	21.00	3.03
3050.0	17.21	31.35	19.04	12.73	2.50	0.91	36.52	21.04	3.01
3100.0	16.91	31.51	18.47	12.15	2.60	0.91	36.72	20.99	2.99
3150.0	16.80	31.37	18.24	12.11	2.59	0.91	37.10	21.05	3.03
3200.0	16.59	31.33	17.60	11.85	2.62	0.91	36.37	21.05	3.05

Typical Performance Curves

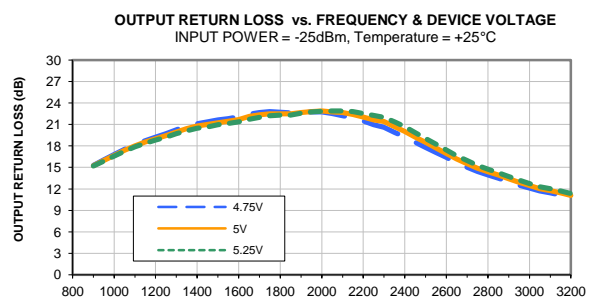
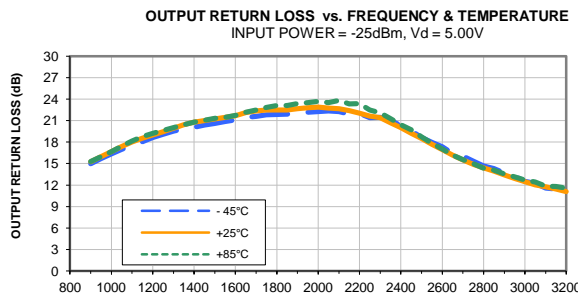
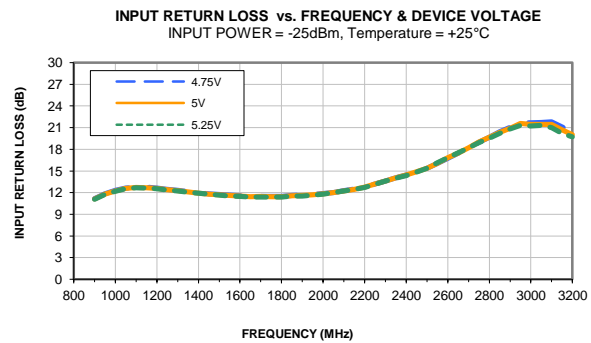
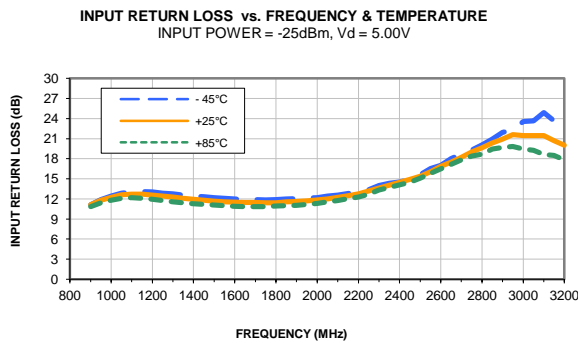
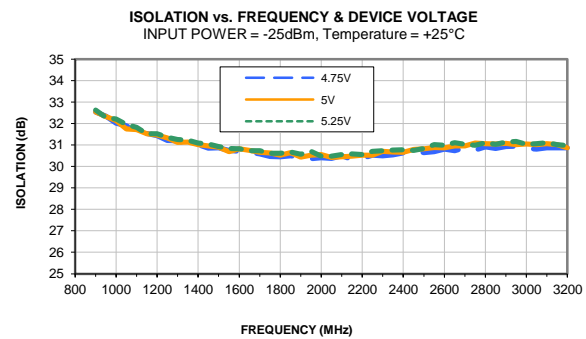
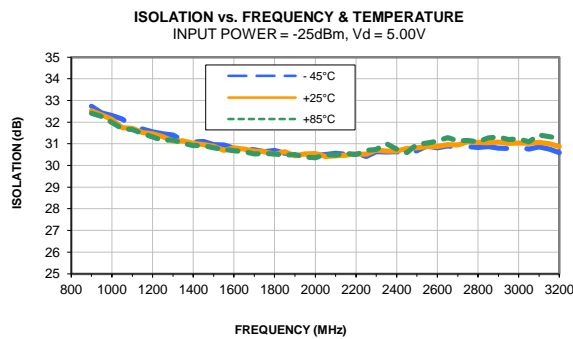
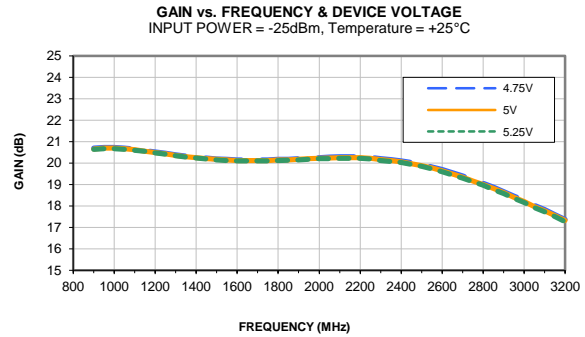
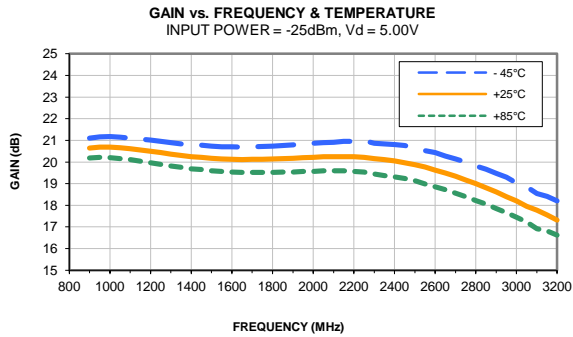

Typical Performance Curves

OUTPUT IP3 vs. FREQUENCY & TEMPERATURE
OUTPUT POWER = 2.5 dBm/tone, Vd = 5.00V

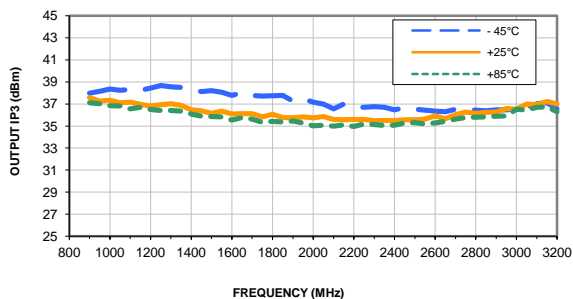

OUTPUT IP3 vs. FREQUENCY & DEVICE VOLTAGE
OUTPUT POWER = 2.5 dBm/tone, Temperature = +25°C

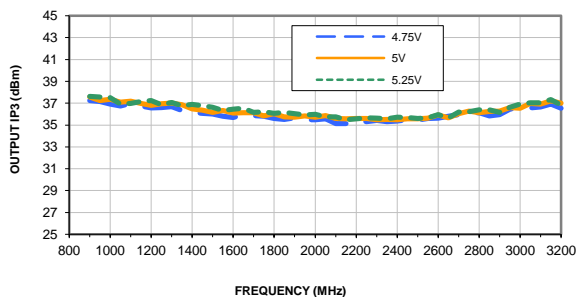

P1dB vs. FREQUENCY & TEMPERATURE
Vd = 5.00V

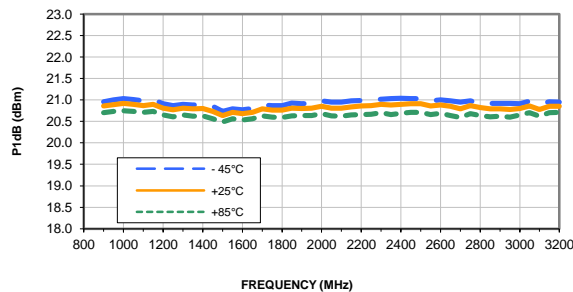

P1dB vs. FREQUENCY & DEVICE VOLTAGE
Temperature = +25°C

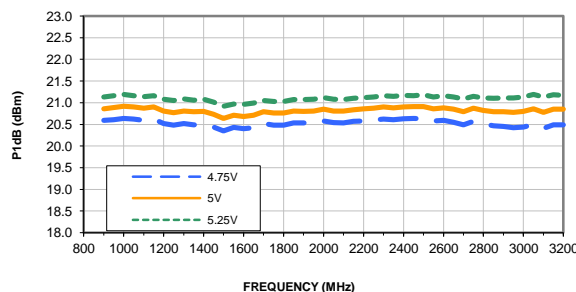

NOISE FIGURE vs. FREQUENCY & TEMPERATURE
Vd = 5.00V

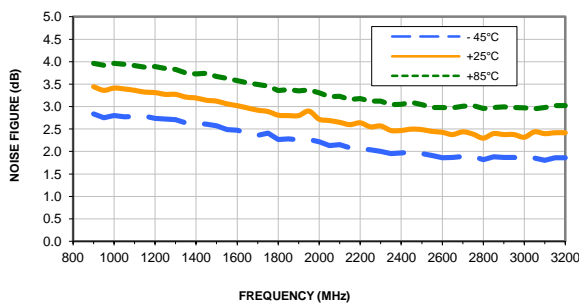

NOISE FIGURE vs. FREQUENCY & DEVICE VOLTAGE
Temperature = +25°C

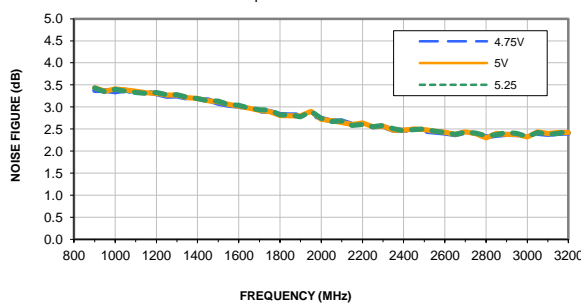

GAIN VARIATION vs. FREQUENCY & TEMPERATURE
INPUT POWER = -25dBm, Vd = 5.00V

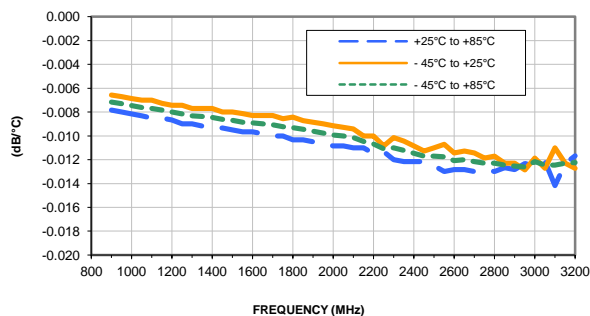

Outline Dimensions

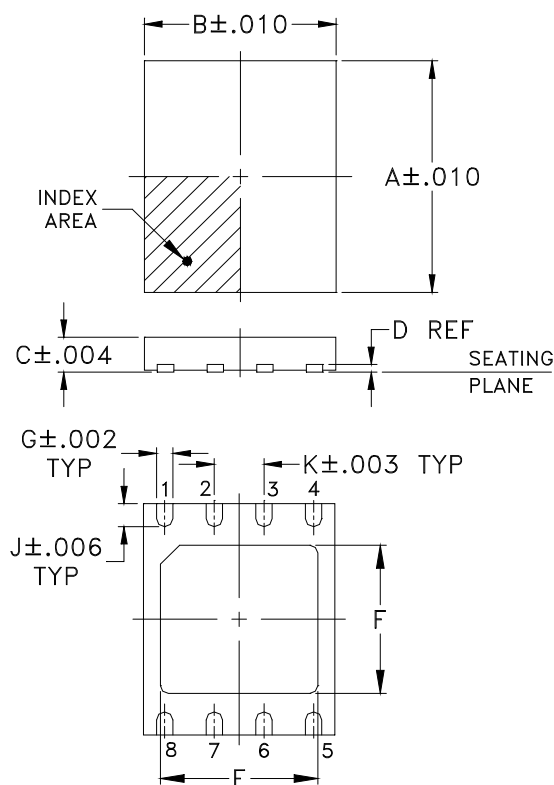

PCB Land Pattern

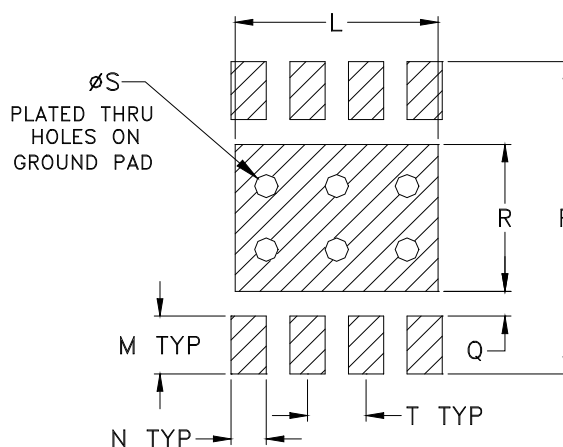

Suggested Layout,
Tolerance to be within $\pm .002$

CASE #	A	B	C	D	E	F	G	H	J	K	L	M	N
DL1636	.236 (6.00)	.193 (4.90)	.035 (0.90)	.008 (0.20)	.160 (4.05)	.153 (3.89)	.017 (0.42)	-- --	.024 (0.60)	.050 (1.27)	.162 (4.11)	.040 (1.02)	.020 (0.51)

CASE #	P	Q	R	S	T	WT. GRAM
DL1636	.257 (6.53)	.011 (0.28)	.155 (3.94)	.020 (0.51)	.050 (1.27)	.08

Dimensions are in inches (mm). Tolerances: 3Pl. $\pm .004$, unless otherwise specified.

Notes:

- Case material: Plastic.
- Termination finish:

For RoHS Case Styles: Tin-Silver-Nickel plate or Matte-Tin. All models, (+) suffix. See model data sheet.
For RoHS-5 Case Styles: Tin-Lead plate. All models, no (+) suffix.



P.O. Box 350166, Brooklyn, New York 11235-0003 (718) 934-4500 Fax (718) 332-4661 For detailed performance specs & shopping online see Mini-Circuits web site



The Design Engineers Search Engine Provides ACTUAL Data Instantly From MINI-CIRCUITS At: www.minicircuits.com

RF/IF MICROWAVE COMPONENTS

Tape & Reel Packaging TR-F68

DEVICE ORIENTATION IN T&R

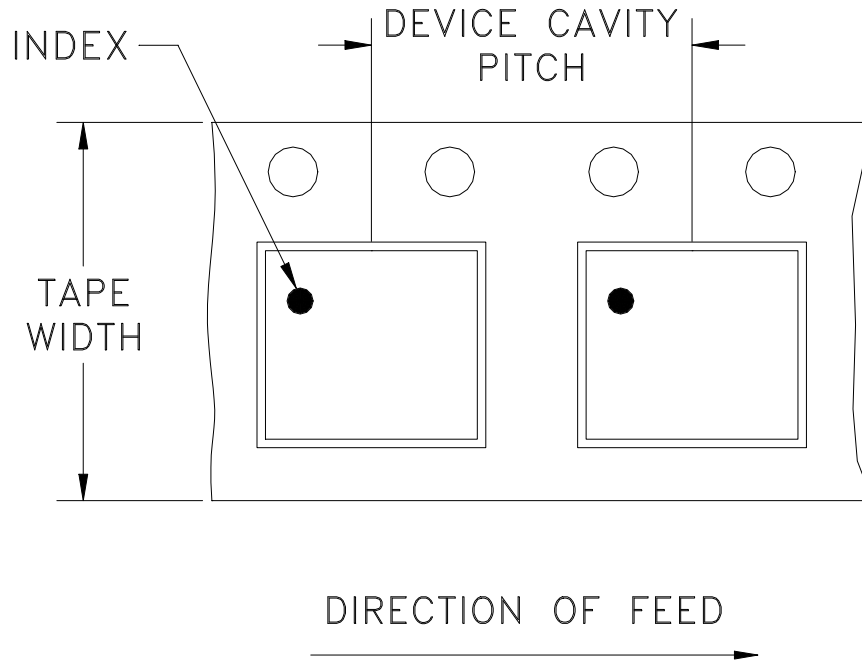

Tape Width, mm	Device Cavity Pitch, mm	Reel Size, inches	Devices per Reel see note	
12	8	7	Small quantity standard	20
				50
				100
				200
				500
		7	Standard	1000
		13	Standard	2000
				3000
4000				

Mini-Circuits carrier tape materials provide protection from ESD (Electro-Static Discharge) during handling and transportation. Tapes are static dissipative and comply with industry standards EIA-481/EIA-541.

Go to: www.minicircuits.com/pages/pdfs/tape.pdf



INTERNET <http://www.minicircuits.com>

P.O. Box 350166, Brooklyn, New York 11235-0003 (718) 934-4500 Fax (718) 332-4661

Distribution Centers NORTH AMERICA 800-654-7949 • 417-335-5935 • Fax 417-335-5945 • EUROPE 44-1252-832600 • Fax 44-1252-837010

Mini-Circuits ISO 9001 & ISO 14001 Certified

THIRD ANGLE PROJECTION

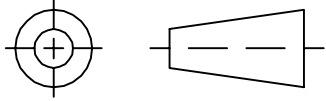

REVISIONS

REV	ECN No.	DESCRIPTION	DATE	DR	AUTH
OR	M133331	NEW RELEASE	11/07/11	PW	TH

SUGGESTED MOUNTING CONFIGURATION FOR DL1636 CASE STYLE, "08AM05" PIN CODE

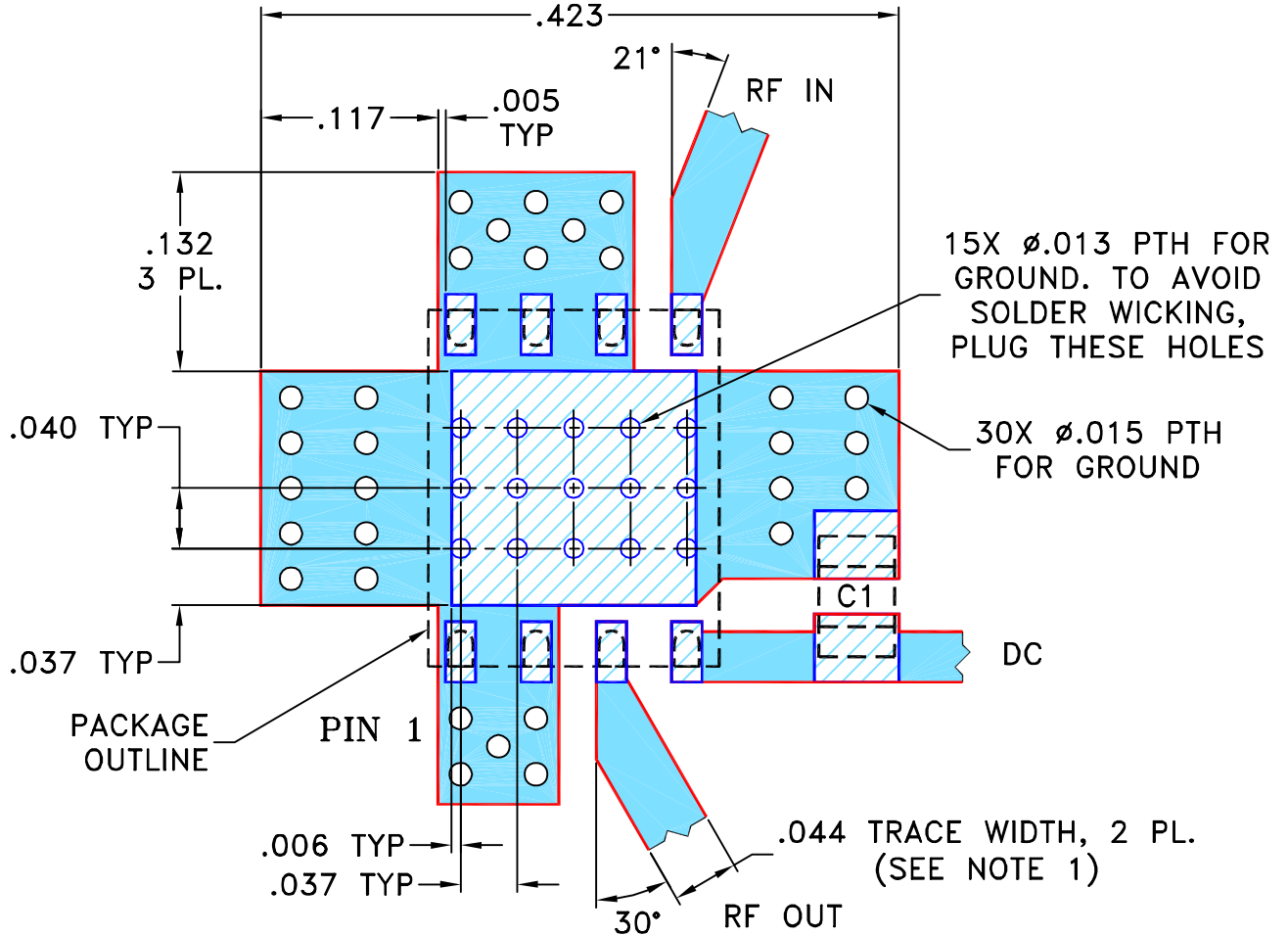

- NOTES: 1. TRACE WIDTH IS SHOWN FOR ROGERS R04350B WITH DIELECTRIC THICKNESS .020" ± .0015". COPPER: 1/2 OZ. EACH SIDE. FOR OTHER MATERIALS TRACE WIDTH MAY NEED TO BE MODIFIED.
 2. FOOTPRINT FOR 0805 CHIP CAPACITOR IS SHOWN FOR REFERENCE.
 3. BOTTOM SIDE OF THE PCB IS CONTINUOUS GROUND PLANE.



DENOTES PCB COPPER LAYOUT WITH SMOBC (SOLDER MASK OVER BARE COPPER)



DENOTES COPPER LAND PATTERN FREE OF SOLDER MASK

UNLESS OTHERWISE SPECIFIED	INITIALS	DATE
DRAWN	PW	08/25/11
CHECKED	IL	10/21/11
APPROVED	TH	11/07/11



Mini-Circuits®

13 Neptune Avenue
Brooklyn NY 11235

PL, 08AM05, DL1636, TB-616-X+

THIS DOCUMENT AND ITS CONTENTS ARE THE PROPERTY OF MINI-CIRCUITS. EXCEPT FOR USE EXPRESSLY GRANTED, IN WRITING, TO ITS VENDORS, VENDEE AND THE UNITED STATES GOVERNMENT, MINI-CIRCUITS RESERVES ALL PROPRIETARY DESIGN, USE, MANUFACTURING AND REPRODUCTION RIGHTS THERETO. THESE CONTENTS SHALL NOT BE USED, DUPLICATED OR DISCLOSED TO ANY OUTSIDE PARTY, IN WHOLE OR IN PART, WITHOUT WRITTEN PERMISSION OF MINI-CIRCUITS.

SIZE	CODE IDENT	DRAWING NO:	REV:
A	15542	98-PL-352	OR
FILE:	98PL352	SCALE:	8:1
SHEET:	1	OF	1

Evaluation Board and Circuit

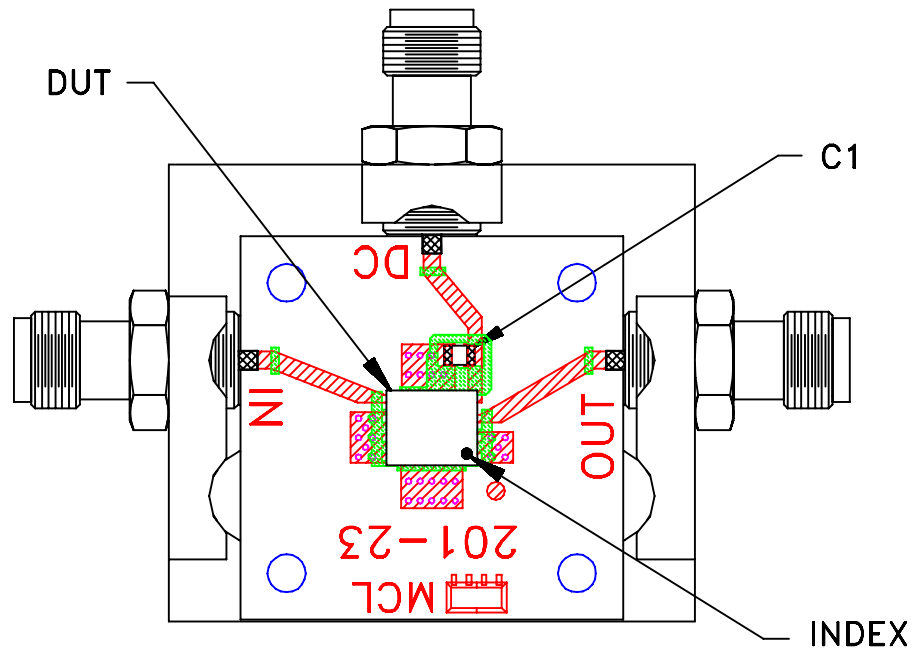

TB-616-1+

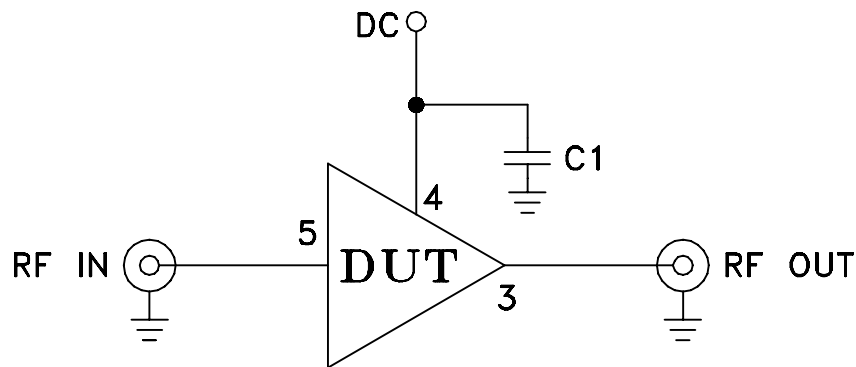

COMPONENT	VALUE
DUT	YSF-322+
C1	1000 pF

Schematic Diagram

Notes:

1. 50 Ohm SMA Female connectors.
2. PCB Material: R04350 or equivalent,
Dielectric Constant=3.5, Thickness=.020 inch.

 **Mini-Circuits®**

All Mini-Circuits products are manufactured under exacting quality assurance and control standards, and are capable of meeting published specifications after being subjected to any or all of the following physical and environmental test.

Specification	Test/Inspection Condition	Reference/Spec
Operating Temperature	-40° to 85°C or -45° to 85°C Ambient Environment	Individual Model Data Sheet
Storage Temperature	-55° to 100° C or -65° to 150° Ambient Environment	Individual Model Data Sheet
Thermal Shock	-55° to 100°C, 100 cycles	MIL-STD-202, Method 107, Condition A-3, except +100°C
Mechanical Shock	1.5Kg, 0.5 ms, 5 shock pulses, Y1 direction only	MIL-STD-883, Method 2002, Condition B, except Y1 direction only
Vibration (Variable Frequency)	50g peak	MIL-STD-883, Method 2007, Condition B
Autoclave	15 psig, 100% RH, 121°C, 96 hours	JESD22-A102, Condition C
HAST	130°C, 85% RH, 96 hours	JESD22-A110
Solderability	10X Magnification	J-STD-002, Para 4.2.5, Test S, 95% Coverage
Solder Reflow Heat	Sn-Pb Eutetic Process: 240°C peak Pb-Free Process: 260°C peak	J-STD-020, Table 4-1, 4-2 and 5-2; Figure 5-1
Moisture Sensitivity: Level 1	Bake at 125°C for 24 hours Soak at 85°C/85% RH for 168 hours, Reflow 3 cycles at 260°C peak	J-STD-020
Marking Resistance to Solvents	Isopropyl alcohol + mineral spirits at 25°C; terpene defluxer at 25°C; distilled water + proylene glycol monomethyl ether +	MIL-STD-202, Method 215



All Mini-Circuits products are manufactured under exacting quality assurance and control standards, and are capable of meeting published specifications after being subjected to any or all of the following physical and environmental test.

Specification	Test/Inspection Condition	Reference/Spec
	monoethanolamine at 63°C to 70°C	