

The Big Deal:

- Ultra Flat Gain Response:
± 0.7 dB over 2300-2700 MHz
- Excellent Combination of gain, P1dB, IP3 and NF
- 50Ω Input and Output:
no External Components Required



CASE STYLE: DL1636

Product Overview:

YSF-272+ is an advanced amplifier module in a Mini-Circuits System In Package **MSiP[®]**. This module is fully matched to 50Ω in/out impedance and has built-in Input & Output DC block capacitors. It is enclosed in a 5 x 6 mm MCLP plastic package. The YSF-272+ uses E-PHEMT technology enabling it to work with a single positive supply voltage.

Key Features

| Feature | Advantages |
|--|---|
| Superior Gain Flatness ± 0.7dB | The YSF-272+ provides industry leading gain flatness over the 2GHz Wimax and UMTS bands (2.3,2.5 and 2.5 to 2.7GHz) making this ideal for use in applications where gain-flatness and repeatability are critical performance requirements. |
| High Gain | The YSF-272+ is a two-stage design with internal feedback and bias to provide flat 20 dB nominal gain, supporting applications where a single gain block must overcome large system losses such as long cable runs and lossy components. |
| Strong Combination of Performance | The YSF-272+ provides a strong combination of performance parameters including high gain (20 dB), high IP3 (+35 dBm) and P1dB (+20 dBm) and low noise figures (2.4 dB) that are difficult to achieve in a single stage design and available only in the YSF amplifier series. |
| Integrated Matching, DC Blocking and Bias in Small Package | The YSF-272+ includes all support circuits including: Matching, Bias and DC Blocking, all integrated into a single 5x6mm package making the total footprint equal to or smaller than most solutions. |
| Excellent Return Loss | The YSF-272+ includes integrated input and output matching and bias circuits to make this amplifier a simple, complete drop-in solution. The matching circuits provide excellent output return loss (20dB), and are designed to give optimal P1dB and IP3 performance in a 50Ω environment. |
| High Reverse Isolation | With 30 dB of reverse isolation – the YSF-272+ is an ideal gain block for use in integrated systems to minimize VSWR interactions resulting from cascading highly reflective components such as sharp filters. |

Notes

- A. Performance and quality attributes and conditions not expressly stated in this specification document are intended to be excluded and do not form a part of this specification document.
 B. Electrical specifications and performance data contained in this specification document are based on Mini-Circuit's applicable established test performance criteria and measurement instructions.
 C. The parts covered by this specification document are subject to Mini-Circuits standard limited warranty and terms and conditions (collectively, "Standard Terms"); Purchasers of this part are entitled to the rights and benefits contained therein. For a full statement of the Standard Terms and the exclusive rights and remedies thereunder, please visit Mini-Circuits' website at www.minicircuits.com/MCLStore/terms.jsp



Flat Gain Amplifier

2.3-2.7 GHz

Product Features

- Matched 50-ohm surface mount amplifier
- High gain, 19 dB typ.
- Up to +20 dBm typ. output power
- High IP3, +35 dBm
- Low Noise Figure, 2.5 dB typ.
- High directivity, 30 dB isolation
- Internal Input & Output DC Block
- Separate terminal for DC
- Protected by us patent 8,994,157



YSF-272+

CASE STYLE: DL1636

+RoHS Compliant

The +Suffix identifies RoHS Compliance. See our web site for RoHS Compliance methodologies and qualifications

Typical Applications

- WiMax
- Portable Wireless
- Receivers & transmitters
- Radar

General Description

YSF-272+ is an advanced amplifier module in a Mini-Circuits System In Package **MSiP[®]**. This module is fully matched to 50Ω in/out impedance and has built-in Input & Output DC block capacitors. It is enclosed in a 5 x 6 mm MCLP plastic package. The YSF-272+ uses E-PHEMT* technology enabling it to work with a single positive supply voltage.

simplified schematic and pad description

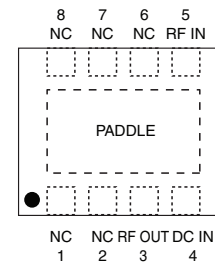
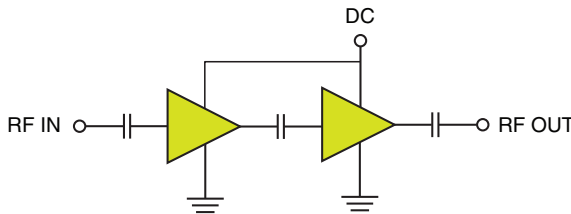

| Function | Pad Number | Description |
|----------|------------|------------------------|
| RF-IN | 5 | RF Input |
| RF-OUT | 3 | RF Output |
| DC | 4 | DC Supply |
| GND | Paddle | Connected to ground |
| NOT USED | 1,2,6,7,8 | No internal connection |

*Enhancement mode Pseudomorphic High Electron Mobility Transistor

Notes

- A. Performance and quality attributes and conditions not expressly stated in this specification document are intended to be excluded and do not form a part of this specification document.
 B. Electrical specifications and performance data contained in this specification document are based on Mini-Circuit's applicable established test performance criteria and measurement instructions.
 C. The parts covered by this specification document are subject to Mini-Circuits standard limited warranty and terms and conditions (collectively, "Standard Terms"); Purchasers of this part are entitled to the rights and benefits contained therein. For a full statement of the Standard Terms and the exclusive rights and remedies thereunder, please visit Mini-Circuits' website at www.minicircuits.com/MCLStore/terms.jsp



Electrical Specifications⁽¹⁾ at 25°C, Zo=50Ω unless noted

| Parameter | Condition (MHz) | Min. | Typ. | Max. | Units |
|--|-----------------|------|-------|------|-------|
| Frequency Range | | | 2300 | | MHz |
| Gain | 2300 | 17.6 | 19.5 | 21.5 | dB |
| | 2500 | 17.1 | 19.0 | 21.5 | |
| | 2700 | 16.2 | 18.0 | 20.5 | |
| Gain Flatness | | | 0.7 | | ±dB |
| Input Return Loss | 2300 | — | 12.6 | | dB |
| | 2500 | 10.0 | 15.0 | | |
| | 2700 | — | 18.0 | | |
| Output Return Loss | 2300 | — | 20.0 | | dB |
| | 2500 | 12.0 | 17.0 | | |
| | 2700 | — | 14.0 | | |
| Reverse Isolation | | | 30.0 | | dB |
| Output Power @ 1 dB compression | 2300 | — | 20.0 | | dBm |
| | 2500 | 18.0 | 20.0 | | |
| | 2700 | — | 20.0 | | |
| Output Power @ 3 dB compression | | | 21.0 | | dBm |
| Output IP3 | 2300 | — | 34.0 | | dBm |
| | 2500 | 30.0 | 35.0 | | |
| | 2700 | — | 35.0 | | |
| Noise Figure | 2300 | | 2.5 | — | dB |
| | 2500 | | 2.5 | 3.5 | |
| | 2700 | | 2.5 | — | |
| Device Operating Voltage | | | 5 | | V |
| Device Operating Current | | | 118 | 145 | mA |
| Device Current Variation vs. Temperature ⁽²⁾ | | | 2 | | µA/°C |
| Device Current Variation vs Voltage | | | 0.002 | | mA/mV |
| Thermal Resistance, junction-to-ground lead ⁽³⁾ | | | 56 | | °C/W |

⁽¹⁾ Measured on Mini-Circuits Characterization test board TB-616+. See Characterization Test Circuit (Fig. 1)

⁽²⁾ D(+85°C to -45°C)

⁽³⁾ Thermal Resistance= $\frac{\text{Hot spot temperature} - \text{Ground lead temperature}}{\text{Power Dissipation}}$

Absolute Maximum Ratings

| Parameter | Ratings | Units |
|--------------------------------------|------------|-------|
| Operating Temperature ⁽⁴⁾ | -40 to 85 | °C |
| Storage Temperature | -65 to 150 | °C |
| DC Voltage on Pad 4 | 7 | V |
| Power Dissipation | 1.5 | W |
| Input Power | 21 | dBm |

Note: Permanent damage may occur if any of these limits are exceeded. These ratings are not intended for continuous normal operation.

⁽⁴⁾ Case is defined as ground paddle.

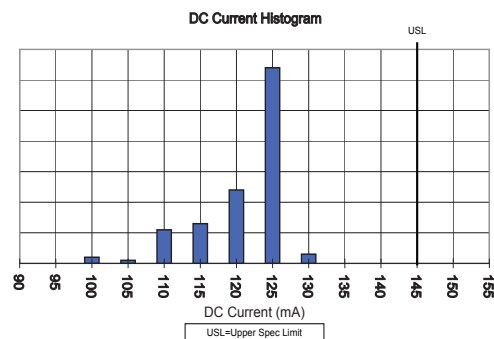

Notes

- A. Performance and quality attributes and conditions not expressly stated in this specification document are intended to be excluded and do not form a part of this specification document.
- B. Electrical specifications and performance data contained in this specification document are based on Mini-Circuit's applicable established test performance criteria and measurement instructions.
- C. The parts covered by this specification document are subject to Mini-Circuits standard limited warranty and terms and conditions (collectively, "Standard Terms"); Purchasers of this part are entitled to the rights and benefits contained therein. For a full statement of the Standard Terms and the exclusive rights and remedies thereunder, please visit Mini-Circuits' website at www.minicircuits.com/MCLStore/terms.jsp



Characterization Test Circuit

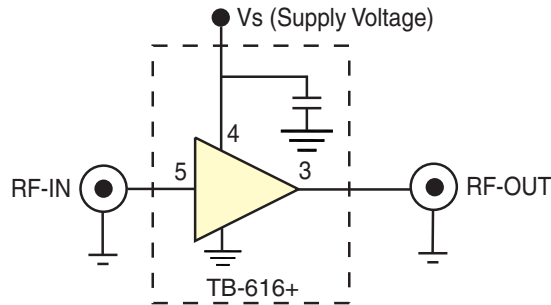

Fig 1. Block Diagram of Test Circuit used for characterization. (DUT soldered on Mini-Circuits Characterization Test Fixture TB-616+) Gain, Return loss, Output power at 1dB compression (P1 dB), Output IP3 (OIP3) and Noise Figure measured using Agilent's N5242A PNA-X microwave network analyzer.

Conditions:

1. Gain: Pin= -25dBm
2. Output IP3 (OIP3): Two tones, spaced 10 MHz apart, 2.5 dBm/tone at output.

Recommended Application Circuit

(refer to evaluation board for PCB Layout and component values)

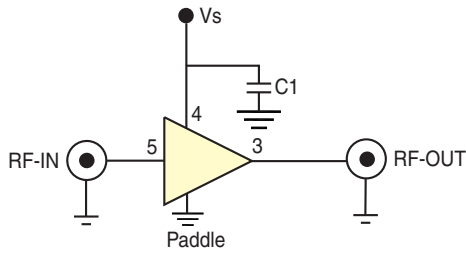
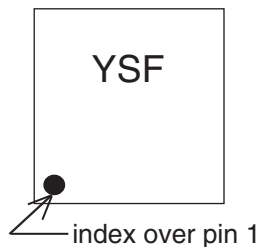

Fig 2. Recommended Application Circuit

Product Marking



Notes

- A. Performance and quality attributes and conditions not expressly stated in this specification document are intended to be excluded and do not form a part of this specification document.
- B. Electrical specifications and performance data contained in this specification document are based on Mini-Circuit's applicable established test performance criteria and measurement instructions.
- C. The parts covered by this specification document are subject to Mini-Circuits standard limited warranty and terms and conditions (collectively, "Standard Terms"); Purchasers of this part are entitled to the rights and benefits contained therein. For a full statement of the Standard Terms and the exclusive rights and remedies thereunder, please visit Mini-Circuits' website at www.minicircuits.com/MCLStore/terms.jsp

| Additional Detailed Technical Information | |
|---|--|
| <i>additional information is available on our dash board. To access this information click here</i> | |
| Performance Data | Data Table |
| | Swept Graphs |
| | S-Parameter (S2P Files) Data Set (.zip file) |
| Case Style | DL1636 <i>Plastic package, exposed paddle, lead finish: tin/silver/nickel</i> |
| Tape & Reel Standard quantities available on reel | F68 <i>7" reels with 20, 50, 100, 200, 500 or 1K devices. 13" reels with 2K, or 4K devices.</i> |
| Suggested Layout for PCB Design | PL-352 |
| Evaluation Board | TB-616-5+ |
| Environmental Ratings | ENV08T1 |

ESD Rating

Human Body Model (HBM): Class 1A in accordance with ANSI/ESD STM 5.1 - 2001

Machine Model (MM): Class M1 (25V) in accordance with ANSI/ESD STM5.2-1999



Attention
 Observe precautions
 for handling electrostatic
 sensitive devices

MSL Rating

Moisture Sensitivity: MSL1 in accordance with IPC/JEDEC J-STD-020D

MSL Test Flow Chart

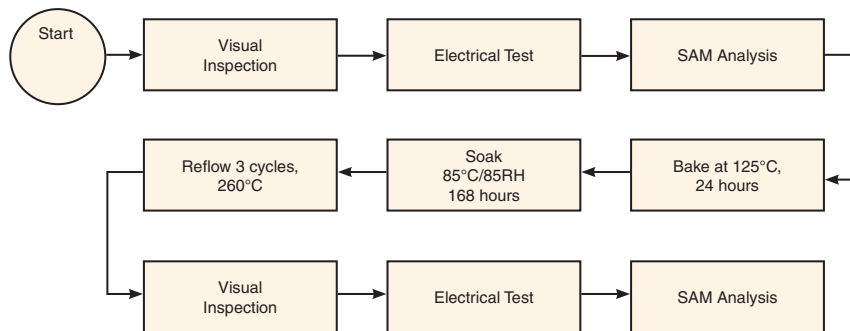

Notes

- A. Performance and quality attributes and conditions not expressly stated in this specification document are intended to be excluded and do not form a part of this specification document.
- B. Electrical specifications and performance data contained in this specification document are based on Mini-Circuit's applicable established test performance criteria and measurement instructions.
- C. The parts covered by this specification document are subject to Mini-Circuits standard limited warranty and terms and conditions (collectively, "Standard Terms"); Purchasers of this part are entitled to the rights and benefits contained therein. For a full statement of the Standard Terms and the exclusive rights and remedies thereunder, please visit Mini-Circuits' website at www.minicircuits.com/MCLStore/terms.jsp



Typical Performance Data

NOTE: Use PDF Bookmarks to view DATA at required conditions

Definitions:

Input Return Loss = -S11 (dB)

Gain(Power Gain) = S21 (dB)

Reverse Isolation = -S12 (dB)

Output Return Loss = -S22 (dB)

TEST CONDITIONS: Vd = 5.00V, Id=122.35mA @ Temperature = +25degC

| FREQ | Gain | Isolation | Input Return Loss | Output Return Loss | Stability | | IP-3 Output | 1dB Comp. Output | Noise Figure |
|--------|-------|-----------|-------------------|--------------------|-----------|---------|-------------|------------------|--------------|
| | | | | | K | Measure | | | |
| (MHz) | (dB) | (dB) | (dB) | (dB) | K | Measure | (dBm) | (dBm) | (dB) |
| 2300.0 | 20.16 | 30.71 | 13.61 | 21.40 | 1.74 | 0.95 | 35.49 | 20.90 | 2.57 |
| 2325.0 | 20.14 | 30.55 | 13.82 | 20.91 | 1.72 | 0.94 | 35.54 | 20.91 | 2.61 |
| 2350.0 | 20.11 | 30.67 | 14.03 | 20.68 | 1.75 | 0.94 | 35.51 | 20.88 | 2.47 |
| 2375.0 | 20.08 | 30.78 | 14.23 | 20.32 | 1.78 | 0.94 | 35.65 | 20.93 | 2.53 |
| 2400.0 | 20.05 | 30.66 | 14.46 | 20.01 | 1.77 | 0.94 | 35.49 | 20.90 | 2.47 |
| 2425.0 | 20.02 | 30.70 | 14.65 | 19.57 | 1.78 | 0.94 | 35.59 | 20.91 | 2.54 |
| 2450.0 | 19.97 | 30.79 | 14.90 | 19.24 | 1.81 | 0.94 | 35.57 | 20.91 | 2.50 |
| 2475.0 | 19.93 | 30.83 | 15.14 | 18.89 | 1.82 | 0.93 | 35.70 | 20.89 | 2.47 |
| 2500.0 | 19.88 | 30.82 | 15.40 | 18.50 | 1.83 | 0.93 | 35.58 | 20.91 | 2.49 |
| 2525.0 | 19.83 | 30.87 | 15.75 | 18.12 | 1.85 | 0.93 | 35.75 | 20.90 | 2.45 |
| 2550.0 | 19.77 | 30.88 | 16.06 | 17.71 | 1.87 | 0.93 | 35.62 | 20.86 | 2.45 |
| 2575.0 | 19.70 | 30.83 | 16.48 | 17.31 | 1.88 | 0.92 | 35.83 | 20.88 | 2.41 |
| 2600.0 | 19.63 | 30.87 | 16.85 | 16.96 | 1.90 | 0.92 | 35.92 | 20.88 | 2.43 |
| 2625.0 | 19.56 | 31.03 | 17.06 | 16.58 | 1.94 | 0.92 | 35.94 | 20.81 | 2.43 |
| 2650.0 | 19.49 | 30.96 | 17.48 | 16.17 | 1.94 | 0.92 | 35.66 | 20.85 | 2.38 |
| 2675.0 | 19.42 | 31.00 | 17.84 | 15.86 | 1.96 | 0.91 | 35.89 | 20.85 | 2.37 |
| 2700.0 | 19.34 | 30.95 | 18.20 | 15.53 | 1.97 | 0.91 | 36.03 | 20.79 | 2.44 |

MSiP Flat Gain Amplifier

YSF-272+

Typical Performance Data

Definitions:

Input Return Loss = -S11 (dB)

Gain(Power Gain) = S21 (dB)

Reverse Isolation = -S12 (dB)

Output Return Loss = -S22 (dB)

TEST CONDITIONS: Vd = 4.75V, Id=121.67mA @ Temperature = +25degC

| FREQ | Gain | Isolation | Input Return Loss | Output Return Loss | Stability | | IP-3 Output | 1dB Comp. Output | Noise Figure |
|--------|-------|-----------|-------------------|--------------------|-----------|---------|-------------|------------------|--------------|
| | | | | | K | Measure | | | |
| (MHz) | (dB) | (dB) | (dB) | (dB) | K | Measure | (dBm) | (dBm) | (dB) |
| 2300.0 | 20.21 | 30.49 | 13.62 | 20.62 | 1.70 | 0.94 | 35.43 | 20.62 | 2.56 |
| 2325.0 | 20.19 | 30.68 | 13.83 | 20.20 | 1.74 | 0.94 | 35.37 | 20.64 | 2.59 |
| 2350.0 | 20.16 | 30.54 | 14.05 | 19.90 | 1.72 | 0.94 | 35.31 | 20.61 | 2.47 |
| 2375.0 | 20.13 | 30.62 | 14.19 | 19.59 | 1.74 | 0.94 | 35.15 | 20.67 | 2.56 |
| 2400.0 | 20.10 | 30.63 | 14.45 | 19.28 | 1.75 | 0.93 | 35.38 | 20.63 | 2.47 |
| 2425.0 | 20.07 | 30.56 | 14.64 | 18.85 | 1.74 | 0.93 | 35.41 | 20.63 | 2.53 |
| 2450.0 | 20.02 | 30.72 | 14.88 | 18.53 | 1.78 | 0.93 | 35.47 | 20.64 | 2.47 |
| 2475.0 | 19.98 | 30.49 | 15.13 | 18.20 | 1.75 | 0.92 | 35.69 | 20.61 | 2.41 |
| 2500.0 | 19.94 | 30.64 | 15.38 | 17.81 | 1.79 | 0.92 | 35.45 | 20.63 | 2.45 |
| 2525.0 | 19.88 | 30.74 | 15.70 | 17.46 | 1.82 | 0.92 | 35.54 | 20.62 | 2.45 |
| 2550.0 | 19.82 | 30.69 | 16.04 | 17.08 | 1.82 | 0.92 | 35.60 | 20.58 | 2.43 |
| 2575.0 | 19.76 | 30.81 | 16.45 | 16.74 | 1.86 | 0.92 | 35.61 | 20.59 | 2.42 |
| 2600.0 | 19.69 | 30.81 | 16.77 | 16.40 | 1.87 | 0.91 | 35.63 | 20.59 | 2.41 |
| 2625.0 | 19.62 | 30.76 | 17.02 | 16.00 | 1.87 | 0.91 | 35.71 | 20.51 | 2.40 |
| 2650.0 | 19.55 | 30.73 | 17.44 | 15.61 | 1.88 | 0.91 | 35.82 | 20.55 | 2.37 |
| 2675.0 | 19.47 | 30.87 | 17.81 | 15.31 | 1.92 | 0.91 | 35.59 | 20.56 | 2.37 |
| 2700.0 | 19.40 | 30.87 | 18.12 | 15.02 | 1.93 | 0.90 | 35.94 | 20.49 | 2.42 |



Typical Performance Data

Definitions:

Input Return Loss = -S11 (dB)

Gain(Power Gain) = S21 (dB)

Reverse Isolation = -S12 (dB)

Output Return Loss = -S22 (dB)

TEST CONDITIONS: Vd = 5.25V, Id=122.70mA @ Temperature = +25degC

| FREQ | Gain | Isolation | Input Return Loss | Output Return Loss | Stability | | IP-3 Output | 1dB Comp. Output | Noise Figure |
|--------|-------|-----------|-------------------|--------------------|-----------|---------|-------------|------------------|--------------|
| | | | | | K | Measure | | | |
| (MHz) | (dB) | (dB) | (dB) | (dB) | K | Measure | (dBm) | (dBm) | (dB) |
| 2300.0 | 20.12 | 30.74 | 13.62 | 22.01 | 1.76 | 0.95 | 35.64 | 21.16 | 2.58 |
| 2325.0 | 20.10 | 30.70 | 13.78 | 21.69 | 1.76 | 0.95 | 35.66 | 21.17 | 2.57 |
| 2350.0 | 20.07 | 30.77 | 14.02 | 21.37 | 1.78 | 0.95 | 35.57 | 21.15 | 2.51 |
| 2375.0 | 20.04 | 30.79 | 14.20 | 21.05 | 1.79 | 0.95 | 35.86 | 21.19 | 2.55 |
| 2400.0 | 20.02 | 30.78 | 14.38 | 20.72 | 1.79 | 0.94 | 35.72 | 21.17 | 2.46 |
| 2425.0 | 19.99 | 30.83 | 14.60 | 20.20 | 1.81 | 0.94 | 35.66 | 21.17 | 2.56 |
| 2450.0 | 19.93 | 30.75 | 14.86 | 19.86 | 1.81 | 0.94 | 35.68 | 21.16 | 2.49 |
| 2475.0 | 19.89 | 30.79 | 15.17 | 19.46 | 1.83 | 0.94 | 35.81 | 21.16 | 2.44 |
| 2500.0 | 19.84 | 30.83 | 15.39 | 19.06 | 1.85 | 0.93 | 35.61 | 21.18 | 2.50 |
| 2525.0 | 19.79 | 30.91 | 15.73 | 18.65 | 1.87 | 0.93 | 35.75 | 21.16 | 2.48 |
| 2550.0 | 19.72 | 31.02 | 16.12 | 18.25 | 1.91 | 0.93 | 35.67 | 21.13 | 2.45 |
| 2575.0 | 19.66 | 31.12 | 16.51 | 17.89 | 1.94 | 0.93 | 35.68 | 21.15 | 2.42 |
| 2600.0 | 19.59 | 30.98 | 16.83 | 17.43 | 1.93 | 0.92 | 35.95 | 21.16 | 2.42 |
| 2625.0 | 19.53 | 31.01 | 17.05 | 17.02 | 1.95 | 0.92 | 35.95 | 21.11 | 2.43 |
| 2650.0 | 19.45 | 31.10 | 17.49 | 16.62 | 1.98 | 0.92 | 35.67 | 21.13 | 2.38 |
| 2675.0 | 19.37 | 31.21 | 17.85 | 16.28 | 2.02 | 0.92 | 35.92 | 21.14 | 2.39 |
| 2700.0 | 19.30 | 31.03 | 18.21 | 15.95 | 2.00 | 0.92 | 36.20 | 21.09 | 2.43 |

MSiP Flat Gain Amplifier

YSF-272+

Typical Performance Data

Definitions:

Input Return Loss = -S11 (dB)

Gain(Power Gain) = S21 (dB)

Reverse Isolation = -S12 (dB)

Output Return Loss = -S22 (dB)

TEST CONDITIONS: Vd = 5.00V, Id=120.34mA @ Temperature = -45degC

| FREQ | Gain | Isolation | Input Return Loss | Output Return Loss | Stability | | IP-3 Output | 1dB Comp. Output | Noise Figure |
|--------|-------|-----------|-------------------|--------------------|-----------|---------|-------------|------------------|--------------|
| | | | | | K | Measure | | | |
| (MHz) | (dB) | (dB) | (dB) | (dB) | K | Measure | (dBm) | (dBm) | (dB) |
| 2300.0 | 20.87 | 30.63 | 14.01 | 21.45 | 1.62 | 0.93 | 36.75 | 21.02 | 2.00 |
| 2325.0 | 20.88 | 30.62 | 14.07 | 21.21 | 1.62 | 0.93 | 36.82 | 21.05 | 2.01 |
| 2350.0 | 20.84 | 30.62 | 14.33 | 21.05 | 1.63 | 0.93 | 36.70 | 21.03 | 1.95 |
| 2375.0 | 20.83 | 30.67 | 14.37 | 20.69 | 1.64 | 0.93 | 36.60 | 21.06 | 1.99 |
| 2400.0 | 20.81 | 30.64 | 14.55 | 20.30 | 1.64 | 0.92 | 36.47 | 21.04 | 1.97 |
| 2425.0 | 20.80 | 30.53 | 14.66 | 19.91 | 1.63 | 0.92 | 36.49 | 21.02 | 1.99 |
| 2450.0 | 20.76 | 30.46 | 14.90 | 19.57 | 1.62 | 0.91 | 36.66 | 21.03 | 1.99 |
| 2475.0 | 20.71 | 30.67 | 15.25 | 18.87 | 1.67 | 0.92 | 36.39 | 21.02 | 1.89 |
| 2500.0 | 20.65 | 30.68 | 15.62 | 18.65 | 1.68 | 0.91 | 36.54 | 21.03 | 1.95 |
| 2525.0 | 20.59 | 30.82 | 16.22 | 18.07 | 1.72 | 0.91 | 36.28 | 20.99 | 1.90 |
| 2550.0 | 20.52 | 30.90 | 16.54 | 17.97 | 1.74 | 0.91 | 36.43 | 20.98 | 1.91 |
| 2575.0 | 20.48 | 30.77 | 16.79 | 17.75 | 1.73 | 0.91 | 36.32 | 21.00 | 1.90 |
| 2600.0 | 20.43 | 30.82 | 17.03 | 17.36 | 1.75 | 0.91 | 36.34 | 21.00 | 1.86 |
| 2625.0 | 20.37 | 30.84 | 17.32 | 16.82 | 1.76 | 0.90 | 36.42 | 20.97 | 1.88 |
| 2650.0 | 20.28 | 30.90 | 18.00 | 16.41 | 1.79 | 0.90 | 36.30 | 20.98 | 1.87 |
| 2675.0 | 20.20 | 30.97 | 18.46 | 16.27 | 1.82 | 0.90 | 36.33 | 20.99 | 1.86 |
| 2700.0 | 20.14 | 30.84 | 18.68 | 16.03 | 1.80 | 0.90 | 36.54 | 20.95 | 1.89 |



P.O. Box 350166, Brooklyn, New York 11235-0003 (718) 934-4500 • Fax (718) 332-4661 For detailed performance specs & shopping online see Mini-Circuits web site
The Design Engineers Search Engine Provides ACTUAL Data Instantly From MINI-CIRCUITS At: www.minicircuits.com



IF/RF MICROWAVE COMPONENTS

REV. OR
YSF-272+
6/28/2013
Page 4 of 9

Typical Performance Data

Definitions:

Input Return Loss = -S11 (dB)

Gain(Power Gain) = S21 (dB)

Reverse Isolation = -S12 (dB)

Output Return Loss = -S22 (dB)

TEST CONDITIONS: Vd = 4.75V, Id=120.40mA @ Temperature = -45degC

| FREQ | Gain | Isolation | Input Return Loss | Output Return Loss | Stability | | IP-3 Output | 1dB Comp. Output | Noise Figure |
|--------|-------|-----------|-------------------|--------------------|-----------|---------|-------------|------------------|--------------|
| | | | | | K | Measure | | | |
| (MHz) | (dB) | (dB) | (dB) | (dB) | K | Measure | (dBm) | (dBm) | (dB) |
| 2300.0 | 20.86 | 30.60 | 13.91 | 21.35 | 1.62 | 0.93 | 36.71 | 20.75 | 2.01 |
| 2325.0 | 20.86 | 30.51 | 13.97 | 21.05 | 1.61 | 0.93 | 36.35 | 20.78 | 2.02 |
| 2350.0 | 20.83 | 30.63 | 14.24 | 20.86 | 1.63 | 0.93 | 36.15 | 20.76 | 1.98 |
| 2375.0 | 20.81 | 30.63 | 14.28 | 20.54 | 1.63 | 0.93 | 36.71 | 20.79 | 2.02 |
| 2400.0 | 20.80 | 30.48 | 14.46 | 20.06 | 1.62 | 0.92 | 36.19 | 20.77 | 1.95 |
| 2425.0 | 20.78 | 30.47 | 14.56 | 19.73 | 1.62 | 0.92 | 36.35 | 20.75 | 2.03 |
| 2450.0 | 20.75 | 30.51 | 14.74 | 19.37 | 1.63 | 0.92 | 36.50 | 20.76 | 1.97 |
| 2475.0 | 20.70 | 30.54 | 15.13 | 18.70 | 1.64 | 0.91 | 36.33 | 20.75 | 1.89 |
| 2500.0 | 20.65 | 30.61 | 15.50 | 18.47 | 1.67 | 0.91 | 36.07 | 20.76 | 1.95 |
| 2525.0 | 20.58 | 30.65 | 16.02 | 17.89 | 1.69 | 0.91 | 36.29 | 20.72 | 1.93 |
| 2550.0 | 20.51 | 30.80 | 16.35 | 17.79 | 1.73 | 0.91 | 36.29 | 20.71 | 1.92 |
| 2575.0 | 20.47 | 30.71 | 16.58 | 17.61 | 1.72 | 0.91 | 36.11 | 20.73 | 1.93 |
| 2600.0 | 20.42 | 30.60 | 16.85 | 17.19 | 1.71 | 0.90 | 36.01 | 20.72 | 1.88 |
| 2625.0 | 20.36 | 30.79 | 17.16 | 16.70 | 1.75 | 0.90 | 36.27 | 20.68 | 1.91 |
| 2650.0 | 20.28 | 30.82 | 17.81 | 16.23 | 1.77 | 0.90 | 36.13 | 20.70 | 1.86 |
| 2675.0 | 20.19 | 30.92 | 18.26 | 16.12 | 1.80 | 0.90 | 35.93 | 20.71 | 1.88 |
| 2700.0 | 20.14 | 30.88 | 18.43 | 15.85 | 1.81 | 0.90 | 36.21 | 20.65 | 1.92 |

MSiP Flat Gain Amplifier

YSF-272+

Typical Performance Data

Definitions:

Input Return Loss = -S11 (dB)

Gain(Power Gain) = S21 (dB)

Reverse Isolation = -S12 (dB)

Output Return Loss = -S22 (dB)

TEST CONDITIONS: Vd = 5.25V, Id=120.94mA @ Temperature = -45degC

| FREQ | Gain | Isolation | Input Return Loss | Output Return Loss | Stability | | IP-3 Output | 1dB Comp. Output | Noise Figure |
|--------|-------|-----------|-------------------|--------------------|-----------|---------|-------------|------------------|--------------|
| | | | | | K | Measure | | | |
| (MHz) | (dB) | (dB) | (dB) | (dB) | K | Measure | (dBm) | (dBm) | (dB) |
| 2300.0 | 20.88 | 30.70 | 14.08 | 21.65 | 1.63 | 0.93 | 36.74 | 21.27 | 2.03 |
| 2325.0 | 20.89 | 30.70 | 14.15 | 21.37 | 1.63 | 0.93 | 36.75 | 21.30 | 2.03 |
| 2350.0 | 20.85 | 30.70 | 14.38 | 21.16 | 1.64 | 0.93 | 36.35 | 21.29 | 1.98 |
| 2375.0 | 20.84 | 30.74 | 14.46 | 20.89 | 1.65 | 0.93 | 36.75 | 21.30 | 2.02 |
| 2400.0 | 20.82 | 30.66 | 14.63 | 20.41 | 1.64 | 0.92 | 36.51 | 21.29 | 1.93 |
| 2425.0 | 20.80 | 30.64 | 14.73 | 20.14 | 1.64 | 0.92 | 36.43 | 21.28 | 2.04 |
| 2450.0 | 20.77 | 30.63 | 14.93 | 19.78 | 1.65 | 0.92 | 36.64 | 21.28 | 1.97 |
| 2475.0 | 20.71 | 30.66 | 15.35 | 19.08 | 1.67 | 0.92 | 36.79 | 21.27 | 1.90 |
| 2500.0 | 20.66 | 30.72 | 15.72 | 18.83 | 1.69 | 0.91 | 36.35 | 21.29 | 1.95 |
| 2525.0 | 20.60 | 30.91 | 16.29 | 18.20 | 1.73 | 0.91 | 36.58 | 21.25 | 1.92 |
| 2550.0 | 20.52 | 30.79 | 16.67 | 18.12 | 1.73 | 0.91 | 36.52 | 21.25 | 1.90 |
| 2575.0 | 20.48 | 30.85 | 16.91 | 17.92 | 1.75 | 0.91 | 36.54 | 21.26 | 1.90 |
| 2600.0 | 20.43 | 30.77 | 17.18 | 17.52 | 1.74 | 0.91 | 36.60 | 21.26 | 1.87 |
| 2625.0 | 20.37 | 30.88 | 17.45 | 17.00 | 1.77 | 0.90 | 36.61 | 21.25 | 1.90 |
| 2650.0 | 20.28 | 30.90 | 18.11 | 16.53 | 1.79 | 0.90 | 36.73 | 21.25 | 1.85 |
| 2675.0 | 20.19 | 31.03 | 18.62 | 16.43 | 1.83 | 0.90 | 36.73 | 21.27 | 1.88 |
| 2700.0 | 20.14 | 31.02 | 18.78 | 16.16 | 1.84 | 0.90 | 36.88 | 21.23 | 1.91 |



P.O. Box 350166, Brooklyn, New York 11235-0003 (718) 934-4500 • Fax (718) 332-4661 For detailed performance specs & shopping online see Mini-Circuits web site
The Design Engineers Search Engine Provides ACTUAL Data Instantly From MINI-CIRCUITS At: www.minicircuits.com



IF/RF MICROWAVE COMPONENTS

REV. OR
YSF-272+
6/28/2013
Page 6 of 9

Typical Performance Data

Definitions:

Input Return Loss = -S11 (dB)

Gain(Power Gain) = S21 (dB)

Reverse Isolation = -S12 (dB)

Output Return Loss = -S22 (dB)

TEST CONDITIONS: Vd = 5.00V, Id=121.83mA @ Temperature = +85degC

| FREQ | Gain | Isolation | Input Return Loss | Output Return Loss | Stability | | IP-3 Output | 1dB Comp. Output | Noise Figure |
|--------|-------|-----------|-------------------|--------------------|-----------|---------|-------------|------------------|--------------|
| | | | | | K | Measure | | | |
| (MHz) | (dB) | (dB) | (dB) | (dB) | K | Measure | (dBm) | (dBm) | (dB) |
| 2300.0 | 19.44 | 30.74 | 13.35 | 22.09 | 1.88 | 0.97 | 35.14 | 20.70 | 3.12 |
| 2325.0 | 19.41 | 30.82 | 13.50 | 21.70 | 1.90 | 0.97 | 34.99 | 20.71 | 3.12 |
| 2350.0 | 19.38 | 31.01 | 13.72 | 21.27 | 1.94 | 0.97 | 35.04 | 20.66 | 3.04 |
| 2375.0 | 19.36 | 30.71 | 13.86 | 20.94 | 1.89 | 0.96 | 35.26 | 20.74 | 3.11 |
| 2400.0 | 19.32 | 30.75 | 14.10 | 20.45 | 1.91 | 0.96 | 35.07 | 20.69 | 3.05 |
| 2425.0 | 19.29 | 30.82 | 14.31 | 19.97 | 1.93 | 0.95 | 35.22 | 20.71 | 3.11 |
| 2450.0 | 19.24 | 30.59 | 14.49 | 19.73 | 1.90 | 0.95 | 35.29 | 20.71 | 3.09 |
| 2475.0 | 19.18 | 30.87 | 14.84 | 19.18 | 1.97 | 0.95 | 35.18 | 20.69 | 2.98 |
| 2500.0 | 19.13 | 30.98 | 15.12 | 18.74 | 2.01 | 0.95 | 35.30 | 20.71 | 3.04 |
| 2525.0 | 19.08 | 31.00 | 15.41 | 18.16 | 2.02 | 0.94 | 35.28 | 20.71 | 3.01 |
| 2550.0 | 18.99 | 31.03 | 15.83 | 17.82 | 2.05 | 0.94 | 35.18 | 20.66 | 2.98 |
| 2575.0 | 18.94 | 30.98 | 16.06 | 17.43 | 2.05 | 0.94 | 35.29 | 20.69 | 2.99 |
| 2600.0 | 18.86 | 31.13 | 16.47 | 17.03 | 2.10 | 0.94 | 35.29 | 20.69 | 2.98 |
| 2625.0 | 18.81 | 31.02 | 16.51 | 16.48 | 2.09 | 0.93 | 35.47 | 20.60 | 3.00 |
| 2650.0 | 18.72 | 31.29 | 17.16 | 16.20 | 2.17 | 0.93 | 35.41 | 20.64 | 2.97 |
| 2675.0 | 18.63 | 31.16 | 17.53 | 15.79 | 2.16 | 0.93 | 35.38 | 20.65 | 2.99 |
| 2700.0 | 18.56 | 31.14 | 17.85 | 15.56 | 2.17 | 0.93 | 35.62 | 20.59 | 3.01 |

Typical Performance Data

Definitions:

Input Return Loss = -S11 (dB)

Gain(Power Gain) = S21 (dB)

Reverse Isolation = -S12 (dB)

Output Return Loss = -S22 (dB)

TEST CONDITIONS: Vd = 4.75V, Id=120.86mA @ Temperature = +85degC

| FREQ | Gain | Isolation | Input Return Loss | Output Return Loss | Stability | | IP-3 Output | 1dB Comp. Output | Noise Figure |
|--------|-------|-----------|-------------------|--------------------|-----------|---------|-------------|------------------|--------------|
| | | | | | K | Measure | | | |
| (MHz) | (dB) | (dB) | (dB) | (dB) | K | Measure | (dBm) | (dBm) | (dB) |
| 2300.0 | 19.46 | 30.65 | 13.32 | 20.89 | 1.85 | 0.96 | 34.75 | 20.39 | 3.09 |
| 2325.0 | 19.44 | 30.74 | 13.46 | 20.57 | 1.87 | 0.96 | 34.62 | 20.40 | 3.09 |
| 2350.0 | 19.41 | 30.72 | 13.72 | 20.12 | 1.88 | 0.96 | 34.63 | 20.35 | 3.02 |
| 2375.0 | 19.39 | 30.65 | 13.84 | 19.82 | 1.87 | 0.95 | 34.75 | 20.44 | 3.06 |
| 2400.0 | 19.35 | 30.64 | 14.08 | 19.41 | 1.88 | 0.95 | 34.70 | 20.39 | 2.99 |
| 2425.0 | 19.32 | 30.74 | 14.27 | 18.92 | 1.91 | 0.95 | 35.01 | 20.40 | 3.08 |
| 2450.0 | 19.27 | 30.68 | 14.46 | 18.66 | 1.91 | 0.95 | 34.88 | 20.42 | 3.07 |
| 2475.0 | 19.21 | 30.78 | 14.83 | 18.18 | 1.94 | 0.94 | 34.85 | 20.38 | 2.93 |
| 2500.0 | 19.16 | 30.75 | 15.07 | 17.80 | 1.95 | 0.94 | 34.89 | 20.40 | 2.98 |
| 2525.0 | 19.11 | 30.80 | 15.37 | 17.27 | 1.97 | 0.94 | 34.92 | 20.40 | 2.98 |
| 2550.0 | 19.02 | 30.94 | 15.81 | 16.96 | 2.02 | 0.94 | 34.82 | 20.35 | 2.97 |
| 2575.0 | 18.97 | 30.86 | 16.04 | 16.60 | 2.01 | 0.93 | 34.88 | 20.37 | 2.93 |
| 2600.0 | 18.89 | 30.96 | 16.47 | 16.23 | 2.05 | 0.93 | 35.04 | 20.37 | 2.95 |
| 2625.0 | 18.84 | 30.82 | 16.50 | 15.74 | 2.03 | 0.92 | 35.15 | 20.25 | 2.97 |
| 2650.0 | 18.75 | 30.99 | 17.12 | 15.46 | 2.09 | 0.92 | 35.07 | 20.31 | 2.90 |
| 2675.0 | 18.66 | 30.95 | 17.51 | 15.10 | 2.10 | 0.92 | 35.34 | 20.32 | 2.93 |
| 2700.0 | 18.60 | 30.86 | 17.81 | 14.91 | 2.09 | 0.92 | 35.48 | 20.24 | 2.99 |

Typical Performance Data

Definitions:

Input Return Loss = -S11 (dB)

Gain(Power Gain) = S21 (dB)

Reverse Isolation = -S12 (dB)

Output Return Loss = -S22 (dB)

TEST CONDITIONS: Vd = 5.25V, Id=122.63mA @ Temperature = +85degC

| FREQ | Gain | Isolation | Input Return Loss | Output Return Loss | Stability | | IP-3 Output | 1dB Comp. Output | Noise Figure |
|--------|-------|-----------|-------------------|--------------------|-----------|---------|-------------|------------------|--------------|
| | | | | | K | Measure | | | |
| (MHz) | (dB) | (dB) | (dB) | (dB) | K | Measure | (dBm) | (dBm) | (dB) |
| 2300.0 | 19.42 | 30.96 | 13.37 | 22.85 | 1.92 | 0.97 | 35.22 | 20.99 | 3.11 |
| 2325.0 | 19.40 | 30.93 | 13.49 | 22.59 | 1.92 | 0.97 | 35.29 | 21.00 | 3.17 |
| 2350.0 | 19.37 | 30.92 | 13.72 | 22.13 | 1.93 | 0.97 | 35.35 | 20.97 | 3.06 |
| 2375.0 | 19.35 | 30.90 | 13.85 | 21.74 | 1.93 | 0.96 | 35.14 | 21.02 | 3.14 |
| 2400.0 | 19.31 | 30.95 | 14.11 | 21.26 | 1.96 | 0.96 | 35.32 | 20.99 | 3.06 |
| 2425.0 | 19.27 | 31.00 | 14.31 | 20.70 | 1.98 | 0.96 | 35.30 | 21.01 | 3.12 |
| 2450.0 | 19.22 | 30.96 | 14.52 | 20.39 | 1.98 | 0.96 | 35.31 | 21.00 | 3.16 |
| 2475.0 | 19.17 | 31.05 | 14.82 | 19.89 | 2.01 | 0.95 | 35.52 | 20.99 | 3.03 |
| 2500.0 | 19.11 | 30.92 | 15.10 | 19.46 | 2.00 | 0.95 | 35.17 | 21.01 | 3.05 |
| 2525.0 | 19.06 | 31.01 | 15.40 | 18.83 | 2.03 | 0.95 | 35.52 | 21.00 | 3.05 |
| 2550.0 | 18.97 | 31.12 | 15.84 | 18.43 | 2.08 | 0.95 | 35.37 | 20.96 | 3.03 |
| 2575.0 | 18.93 | 31.13 | 16.05 | 18.08 | 2.09 | 0.94 | 35.34 | 20.99 | 3.02 |
| 2600.0 | 18.84 | 31.21 | 16.49 | 17.58 | 2.13 | 0.94 | 35.55 | 20.99 | 3.00 |
| 2625.0 | 18.79 | 31.08 | 16.50 | 17.01 | 2.11 | 0.94 | 35.63 | 20.92 | 3.07 |
| 2650.0 | 18.70 | 31.28 | 17.09 | 16.70 | 2.18 | 0.94 | 35.50 | 20.96 | 3.00 |
| 2675.0 | 18.61 | 31.29 | 17.48 | 16.26 | 2.20 | 0.93 | 35.64 | 20.96 | 3.00 |
| 2700.0 | 18.54 | 31.32 | 17.77 | 16.04 | 2.22 | 0.93 | 35.75 | 20.91 | 3.05 |

Typical Performance Curves

GAIN vs. FREQUENCY & TEMPERATURE
INPUT POWER = -25dBm, Vd = 5.00V

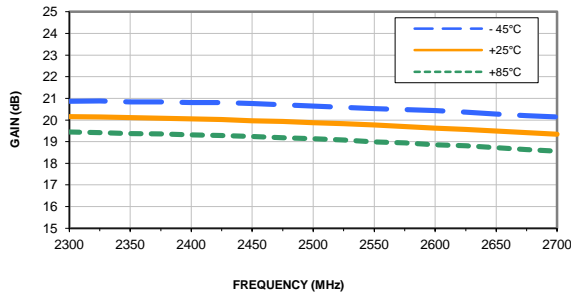

GAIN vs. FREQUENCY & DEVICE VOLTAGE
INPUT POWER = -25dBm, Temperature = +25°C

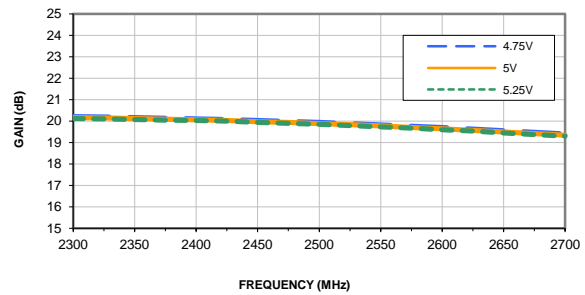

ISOLATION vs. FREQUENCY & TEMPERATURE
INPUT POWER = -25dBm, Vd = 5.00V

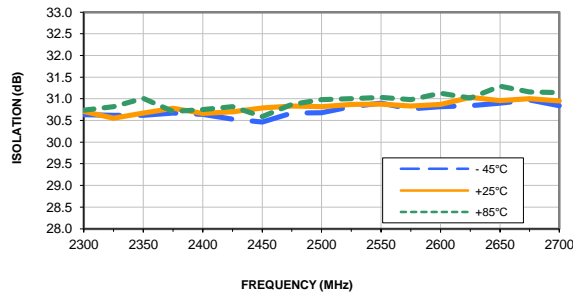

ISOLATION vs. FREQUENCY & DEVICE VOLTAGE
INPUT POWER = -25dBm, Temperature = +25°C

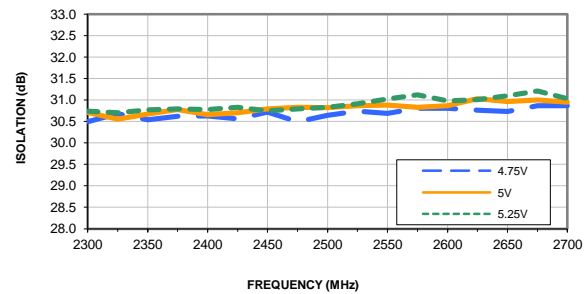

INPUT RETURN LOSS vs. FREQUENCY & TEMPERATURE
INPUT POWER = -25dBm, Vd = 5.00V

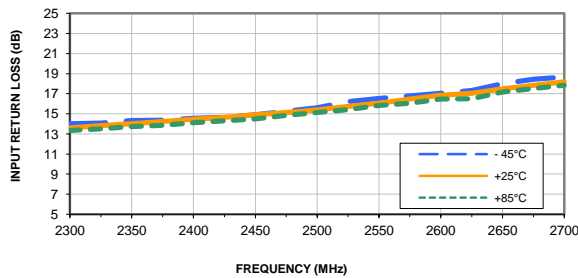

INPUT RETURN LOSS vs. FREQUENCY & DEVICE VOLTAGE
INPUT POWER = -25dBm, Temperature = +25°C

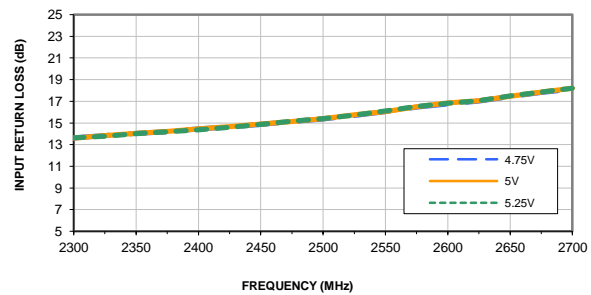

OUTPUT RETURN LOSS vs. FREQUENCY & TEMPERATURE
INPUT POWER = -25dBm, Vd = 5.00V

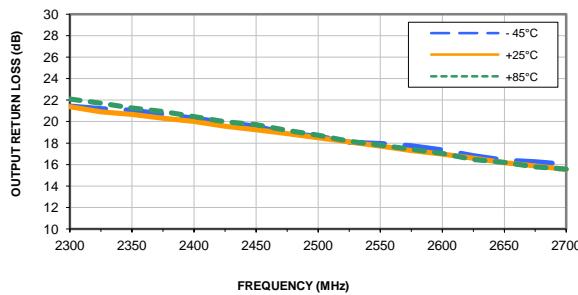

OUTPUT RETURN LOSS vs. FREQUENCY & DEVICE VOLTAGE
INPUT POWER = -25dBm, Temperature = +25°C

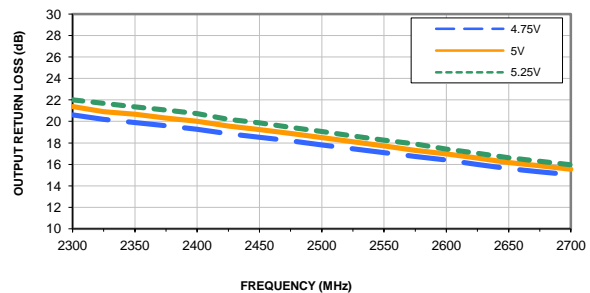

Typical Performance Curves

OUTPUT IP3 vs. FREQUENCY & TEMPERATURE
OUTPUT POWER = 2.5 dBm/tone, Vd = 5.00V

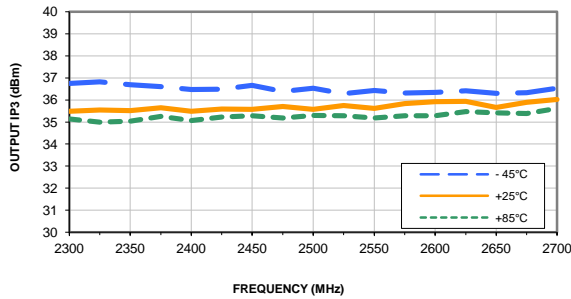

OUTPUT IP3 vs. FREQUENCY & DEVICE VOLTAGE
OUTPUT POWER = 2.5 dBm/tone, Temperature = +25°C

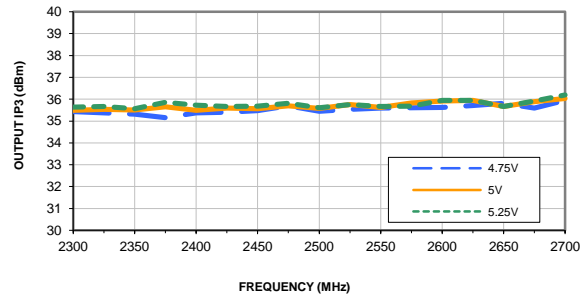

P1dB vs. FREQUENCY & TEMPERATURE
Vd = 5.00V

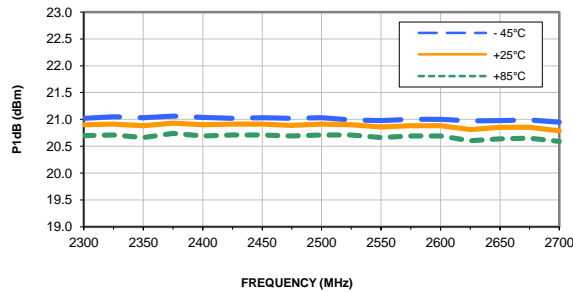

P1dB vs. FREQUENCY & DEVICE VOLTAGE
Temperature = +25°C

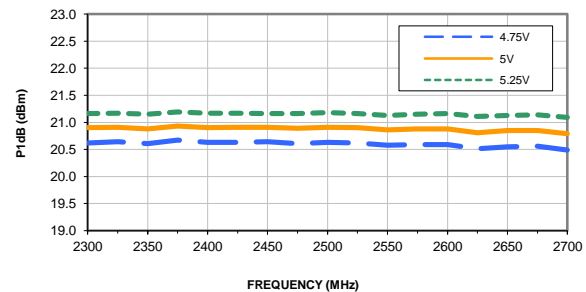

NOISE FIGURE vs. FREQUENCY & TEMPERATURE
Vd = 5.00V

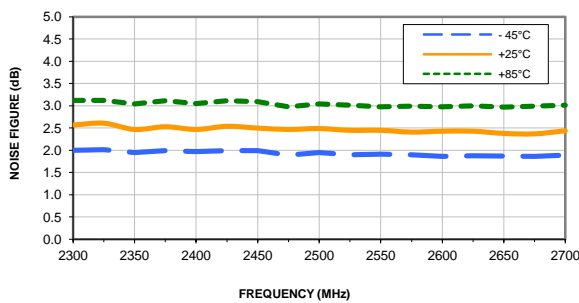

NOISE FIGURE vs. FREQUENCY & DEVICE VOLTAGE
Temperature = +25°C

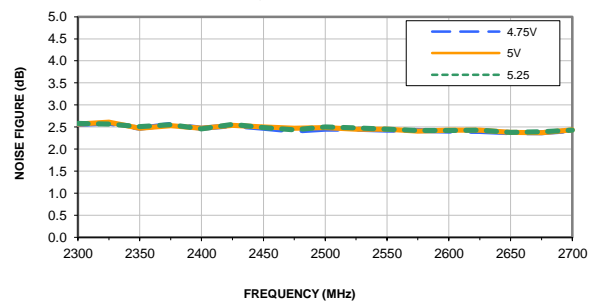

GAIN VARIATION vs. FREQUENCY & TEMPERATURE
INPUT POWER = -25dBm, Vd = 5.00V

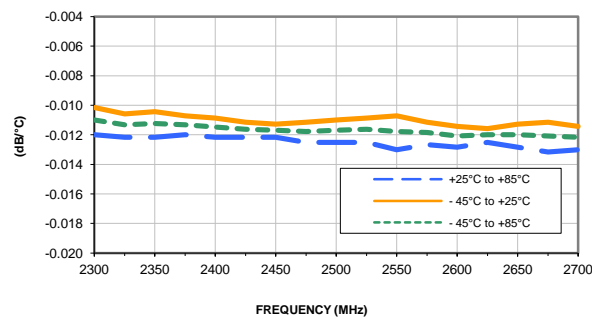

Outline Dimensions

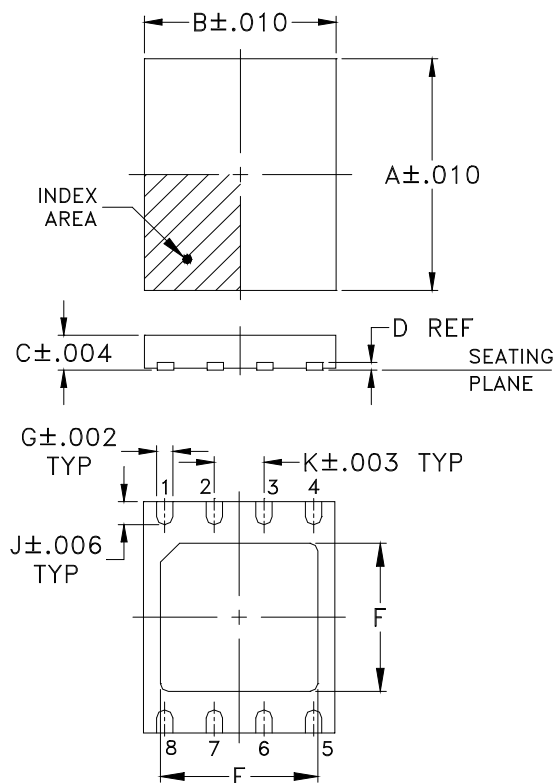

PCB Land Pattern

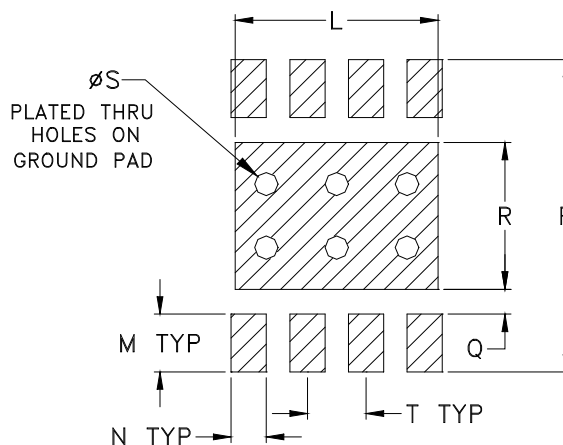

Suggested Layout,
Tolerance to be within $\pm .002$

| CASE # | A | B | C | D | E | F | G | H | J | K | L | M | N |
|--------|----------------|----------------|----------------|----------------|----------------|----------------|----------------|----------|----------------|----------------|----------------|----------------|----------------|
| DL1636 | .236 (6.00) | .193 (4.90) | .035 (0.90) | .008 (0.20) | .160 (4.05) | .153 (3.89) | .017 (0.42) | -- -- | .024 (0.60) | .050 (1.27) | .162 (4.11) | .040 (1.02) | .020 (0.51) |

| CASE # | P | Q | R | S | T | WT. GRAM |
|--------|----------------|----------------|----------------|----------------|----------------|----------|
| DL1636 | .257 (6.53) | .011 (0.28) | .155 (3.94) | .020 (0.51) | .050 (1.27) | .08 |

Dimensions are in inches (mm). Tolerances: 3Pl. $\pm .004$, unless otherwise specified.

Notes:

- Case material: Plastic.
- Termination finish:

For RoHS Case Styles: Tin-Silver-Nickel plate or Matte-Tin. All models, (+) suffix. See model data sheet.
For RoHS-5 Case Styles: Tin-Lead plate. All models, no (+) suffix.



P.O. Box 350166, Brooklyn, New York 11235-0003 (718) 934-4500 Fax (718) 332-4661 For detailed performance specs & shopping online see Mini-Circuits web site



The Design Engineers Search Engine Provides ACTUAL Data Instantly From MINI-CIRCUITS At: www.minicircuits.com

RF/IF MICROWAVE COMPONENTS

Tape & Reel Packaging TR-F68

DEVICE ORIENTATION IN T&R

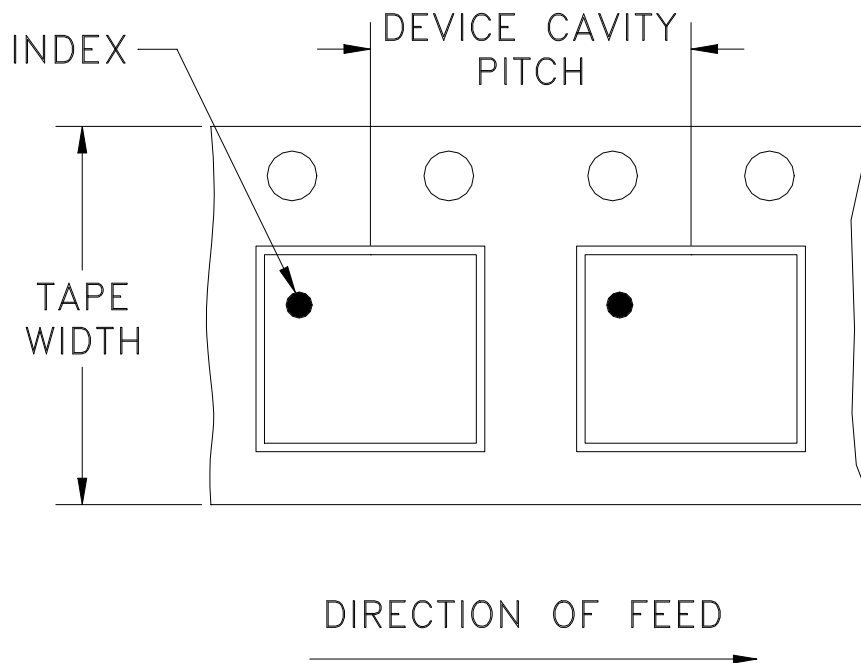

| Tape Width, mm | Device Cavity Pitch, mm | Reel Size, inches | Devices per Reel see note | |
|----------------|-------------------------|-------------------|---------------------------|------|
| 12 | 8 | 7 | Small quantity standard | 20 |
| | | | | 50 |
| | | | | 100 |
| | | | | 200 |
| | | | | 500 |
| | | 7 | Standard | 1000 |
| | | 13 | Standard | 2000 |
| | | | | 3000 |
| 4000 | | | | |

Mini-Circuits carrier tape materials provide protection from ESD (Electro-Static Discharge) during handling and transportation. Tapes are static dissipative and comply with industry standards EIA-481/EIA-541.

Go to: www.minicircuits.com/pages/pdfs/tape.pdf



INTERNET <http://www.minicircuits.com>

P.O. Box 350166, Brooklyn, New York 11235-0003 (718) 934-4500 Fax (718) 332-4661

Distribution Centers NORTH AMERICA 800-654-7949 • 417-335-5935 • Fax 417-335-5945 • EUROPE 44-1252-832600 • Fax 44-1252-837010

Mini-Circuits ISO 9001 & ISO 14001 Certified

Evaluation Board and Circuit

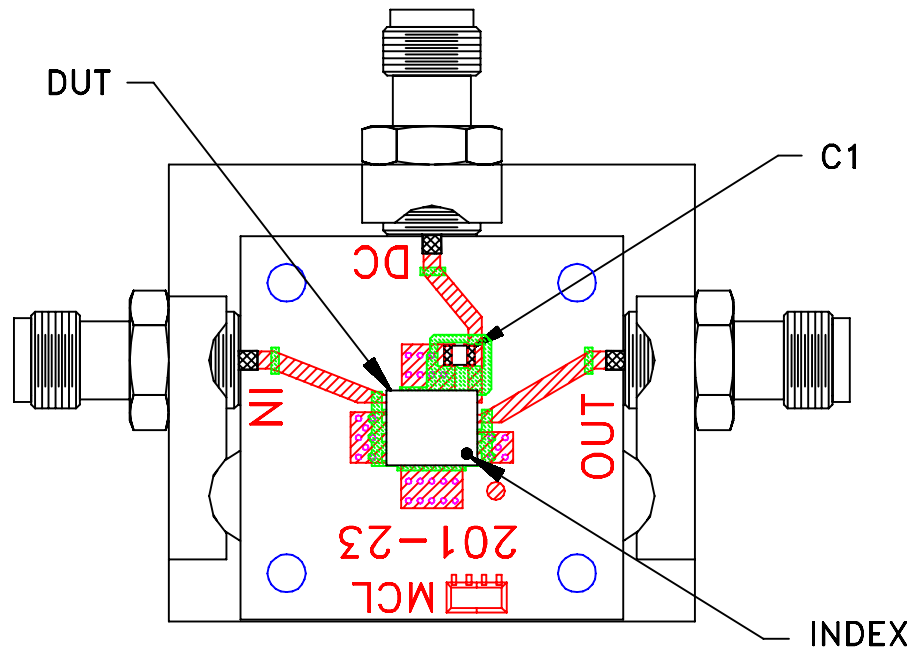

TB-616-5+

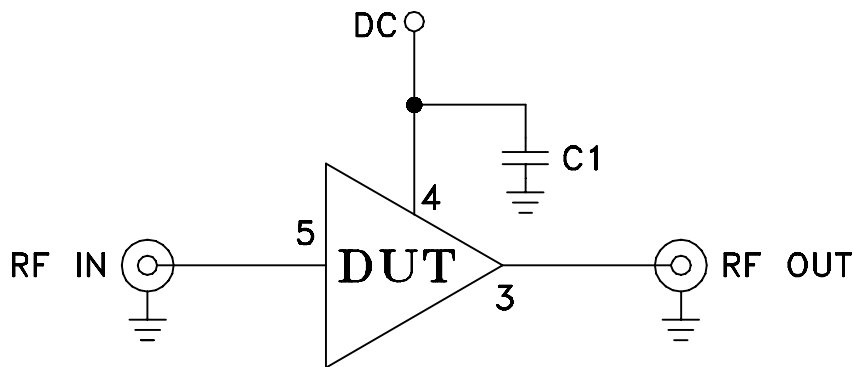

| COMPONENT | VALUE |
|-----------|----------|
| DUT | YSF-272+ |
| C1 | 1000 pF |

Schematic Diagram

Notes:

1. 50 Ohm SMA Female connectors.
2. PCB Material: R04350 or equivalent,
Dielectric Constant=3.5, Thickness=.020 inch.

 **Mini-Circuits®**

All Mini-Circuits products are manufactured under exacting quality assurance and control standards, and are capable of meeting published specifications after being subjected to any or all of the following physical and environmental test.

| Specification | Test/Inspection Condition | Reference/Spec |
|--------------------------------|--|---|
| Operating Temperature | -40° to 85°C or -45° to 85°C Ambient Environment | Individual Model Data Sheet |
| Storage Temperature | -55° to 100° C or -65° to 150° Ambient Environment | Individual Model Data Sheet |
| Thermal Shock | -55° to 100°C, 100 cycles | MIL-STD-202, Method 107, Condition A-3, except +100°C |
| Mechanical Shock | 1.5Kg, 0.5 ms, 5 shock pulses, Y1 direction only | MIL-STD-883, Method 2002, Condition B, except Y1 direction only |
| Vibration (Variable Frequency) | 50g peak | MIL-STD-883, Method 2007, Condition B |
| Autoclave | 15 psig, 100% RH, 121°C, 96 hours | JESD22-A102, Condition C |
| HAST | 130°C, 85% RH, 96 hours | JESD22-A110 |
| Solderability | 10X Magnification | J-STD-002, Para 4.2.5, Test S, 95% Coverage |
| Solder Reflow Heat | Sn-Pb Eutetic Process: 240°C peak Pb-Free Process: 260°C peak | J-STD-020, Table 4-1, 4-2 and 5-2; Figure 5-1 |
| Moisture Sensitivity: Level 1 | Bake at 125°C for 24 hours Soak at 85°C/85% RH for 168 hours, Reflow 3 cycles at 260°C peak | J-STD-020 |
| Marking Resistance to Solvents | Isopropyl alcohol + mineral spirits at 25°C; terpene defluxer at 25°C; distilled water + proylene glycol monomethyl ether + | MIL-STD-202, Method 215 |



All Mini-Circuits products are manufactured under exacting quality assurance and control standards, and are capable of meeting published specifications after being subjected to any or all of the following physical and environmental test.

| Specification | Test/Inspection Condition | Reference/Spec |
|----------------------|----------------------------------|-----------------------|
| | monoethanolamine at 63°C to 70°C | |