



MICROWAVE PRECISION

Fixed Attenuator

YAT-4A+

50Ω 1.7W 4 dB DC to 18 GHz

THE BIG DEAL

- Exceptional Power Handling
- Wide bandwidth, DC-18 GHz
- Miniature package MCLP™ 2 x 2 mm
- Excellent attenuation accuracy & flatness

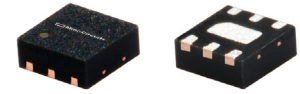

Generic photo used for illustration purposes only

CASE STYLE: MC1630

+RoHS Compliant

The +Suffix identifies RoHS Compliance. See our website for methodologies and qualifications

APPLICATIONS

- Cellular
- PCS
- Communications
- Radar
- Defense

PRODUCT OVERVIEW

YAT-4A+ (RoHS compliant) is a fixed value, absorptive MMIC attenuator fabricated using highly repetitive IPD process technology with thin film resistors on GaAs substrates. This design incorporates through-wafer metallization vias to realize low thermal resistance and wideband operation with outstanding attenuation accuracy and flatness over its full operating bandwidth. **YAT-A family attenuators are available with nominal attenuation values of 0 to 10 dB (in 1 dB steps), 12, 15, 20, and 30 dB. Packaged in a tiny 2 x 2 mm MCLP™ package, it's ideal for tight spaces in crowded board layouts. Also available in die form.**

KEY FEATURES

Feature	Advantages
Wideband operation, DC to 18 GHz	Supports a wide array of applications including wireless cellular, microwave Communications, satellite, Defense and aerospace, medical broadband and optic applications.
Small Size and simple to use (2 mm x 2 mm)	As a single chip solution, the YAT-A series occupies less board space than a "T" or "Pi" pad configuration, and ensures repeatable performance over wide frequency ranges.
High Power, Up to 1.7W	High power handling in a small size package.
Wide range of nominal attenuation values 0 to 10 dB (in 1 dB steps), and 12, 15, 20, and 30 dB	Small increment offering enables circuit designer to change attenuation values without motherboard redesign making the YAT-A series ideal for select at test application.
MCLP™ Package	Low Inductance, repeatable transitions, excellent thermal path make the YAT-A series an ideal solution as an alternative to "do it yourself" resistor based attenuators.

REV. A
ECO-011434
YAT-4A+
MCL NY
220930





ELECTRICAL SPECIFICATIONS¹ AT 25°C, 50Ω (CPW)

Parameter	Frequency (GHz)	Min.	Typ.	Max.	Unit
Frequency Range		DC	—	18	GHz
Attenuation	0.01	—	4	—	dB
	DC - 5	3.5	3.92	4.3	
	5 - 15	3.6	3.98	4.4	
	15 - 18	3.6	4.07	4.6	
VSWR	DC - 5	—	1.12	1.32	:1
	5 - 15	—	1.16	1.90	
	15 - 18	—	1.29	1.96	

1. Tested on Mini-Circuits test board TB-YAT-4A+ using coplanar wave guide (CPW) input and output traces (see suggested PCB layout on page 4 of this data sheet)

MAXIMUM RATINGS⁴

Parameter	Ratings
Operating Case Temperature ³	-40°C to 85°C
Storage Temperature	-65°C to 150°C
RF Input Power ²	1.7 W

2. RF Power at 25°C case temperature: 1.7 Watt. Derate linearly to 1.0 W at 85°C.

3. Case is defined as ground lead.

4. Permanent damage may occur if any of these limits are exceeded.

PAD DESCRIPTION

Function	Pad Number	Description
RF-IN	2	RF input pad
RF-OUT	5	RF output pad
GND	1,3,4,6 Bottom Exposed pad	Connected to ground externally

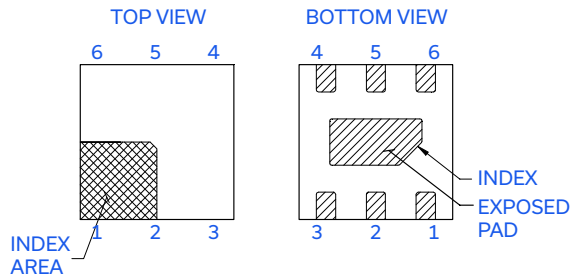

CHARACTERIZATION TEST CIRCUIT

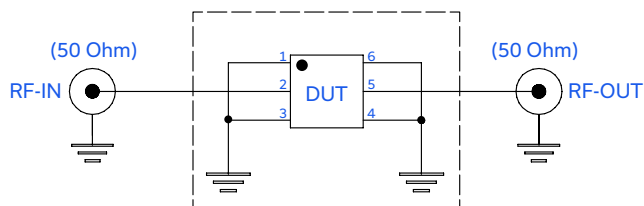

Fig 1. Block diagram of Test Circuit used for characterization, Test board TB-YAT-5A+ Conditions: Attenuation, VSWR: Pin=-10 dBm



MICROWAVE PRECISION

Fixed Attenuator

YAT-4A+

Mini-Circuits

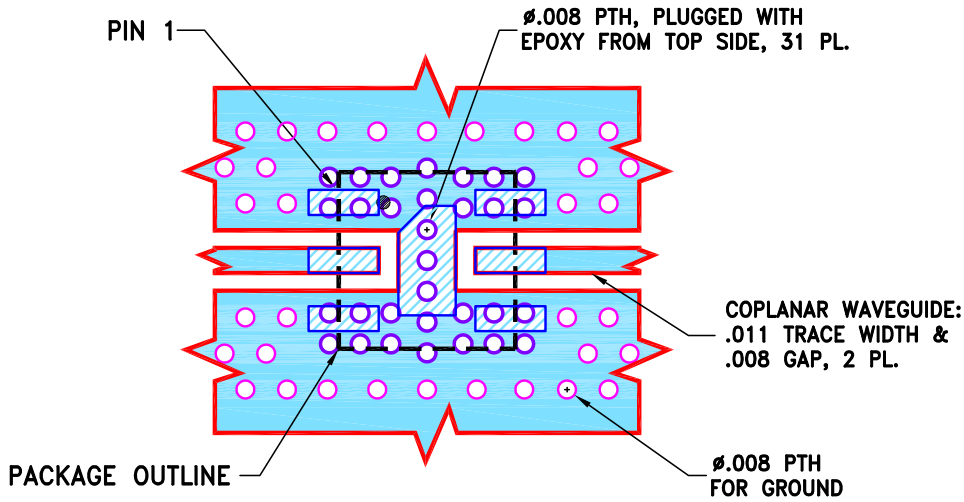

50Ω 1.7W 4 dB DC to 18 GHz

SUGGESTED PCB LAYOUT (PL-586)



NOTES:

- TRACE WIDTH & GAP PARAMETERS ARE SHOWN FOR ROGERS RO4350B WITH DIELECTRIC THICKNESS $.0066 \pm .0007$. COPPER: 1/2 OZ. EACH SIDE. FOR OTHER MATERIALS TRACE WIDTH & GAP MAY NEED TO BE MODIFIED.
- BOTTOM SIDE OF THE PCB IS CONTINUOUS GROUND PLANE.

-  DENOTES PCB COPPER LAYOUT WITH SMOBC (SOLDER MASK OVER BARE COPPER).
-  DENOTES COPPER LAND PATTERN FREE OF SOLDER MASK.

PRODUCT MARKING

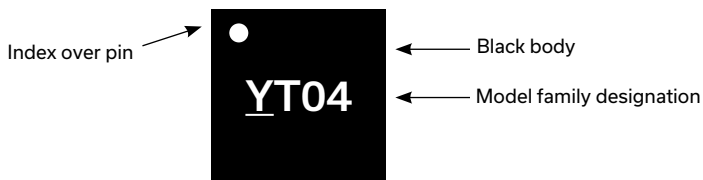

Marking may contain other features or characters for internal lot control

Mini-Circuits



MICROWAVE PRECISION

Fixed Attenuator

YAT-4A+

Mini-Circuits

50Ω 1.7W 4 dB DC to 18 GHz

TYPICAL PERFORMANCE DATA AT 25°C

Frequency (GHz)	Attenuation (dB)	VSWR (:1)
0.010	3.89	1.15
1.0	3.93	1.11
2.0	3.94	1.12
4.0	3.93	1.09
5.0	3.92	1.10
8.0	3.97	1.19
10.0	4.01	1.19
12.0	4.07	1.28
15.0	4.09	1.30
16.0	4.09	1.30
18.0	4.14	1.38

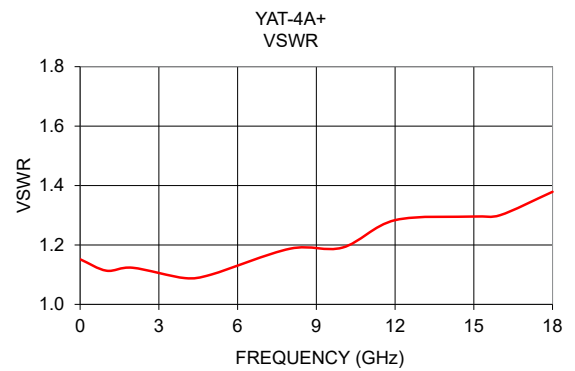
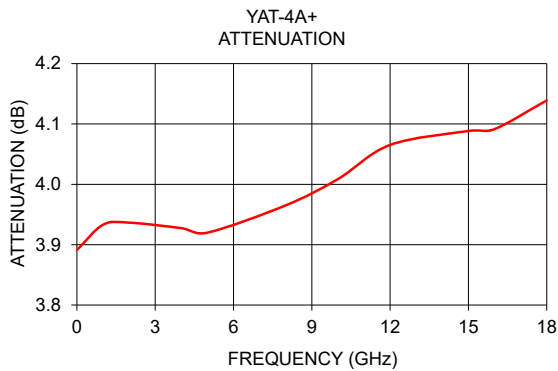



MICROWAVE PRECISION

Fixed Attenuator

YAT-4A+

Mini-Circuits

50Ω 1.7W 4 dB DC to 18 GHz

ADDITIONAL DETAILED TECHNICAL INFORMATION IS AVAILABLE ON OUR DASH BOARD. TO ACCESS [CLICK HERE](#)

Performance Data	Data Table Swept Graphs
Case Style	MC1630 Plastic package, Terminal finish: Matte Tin Plate
Tape & Reel Standard quantities available on reel	F108 7" reels with 20, 50, 100, 200, 500, 1K, or 2K devices
Suggested Layout for PCB Design	PL-586
Evaluation Board	TB-YAT-4A+
Environmental Ratings	ENV08T1

ESD RATING

Human Body Model (HBM): Class 2 (Pass 2000 V) per ANSI/ESD STM 5.1-2001

MSL RATING

Moisture Sensitivity: MSL1 in accordance with IPC/JEDEC J-STD-020D

- NOTES**
- A. Performance and quality attributes and conditions not expressly stated in this specification document are intended to be excluded and do not form a part of this specification document.
 - B. Electrical specifications and performance data contained in this specification document are based on Mini-Circuit's applicable established test performance criteria and measurement instructions.
 - C. The parts covered by this specification document are subject to Mini-Circuits standard limited warranty and terms and conditions (collectively, "Standard Terms"); Purchasers of this part are entitled to the rights and benefits contained therein. For a full statement of the standard. Terms and the exclusive rights and remedies thereunder, please visit Mini-Circuits' website at www.minicircuits.com/MCLStore/terms.jsp



Typical Performance Data

FREQUENCY (MHz)	ATTENUATION (dB)	VSWR (:1)
10	3.89	1.15
50	3.91	1.16
100	3.91	1.14
200	3.91	1.13
300	3.91	1.12
400	3.92	1.12
500	3.92	1.12
1000	3.93	1.11
1500	3.94	1.10
2000	3.93	1.11
2500	3.94	1.10
3000	3.92	1.11
3500	3.90	1.09
4000	3.93	1.09
4500	3.90	1.08
5000	3.89	1.09
5500	3.91	1.13
6000	3.92	1.15
6500	3.94	1.18
7000	3.96	1.19
7500	3.97	1.19
8000	3.97	1.19
8500	3.99	1.17
9000	3.99	1.17
9500	4.01	1.18
10000	4.01	1.19
10500	4.02	1.22
11000	4.04	1.25
11500	4.05	1.27
12000	4.06	1.28
12500	4.08	1.28
13000	4.08	1.28
13500	4.07	1.28
14000	4.08	1.28
14500	4.08	1.29
15000	4.09	1.30
15500	4.10	1.30
16000	4.09	1.30
16500	4.10	1.30
17000	4.09	1.31
17500	4.11	1.33
18000	4.14	1.38

Typical Performance Curves

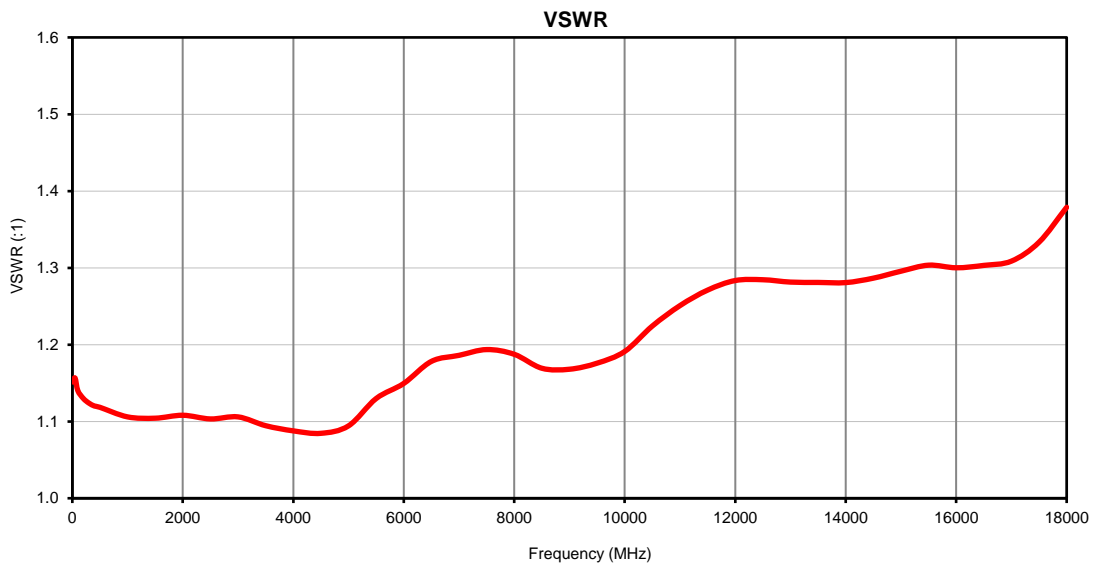
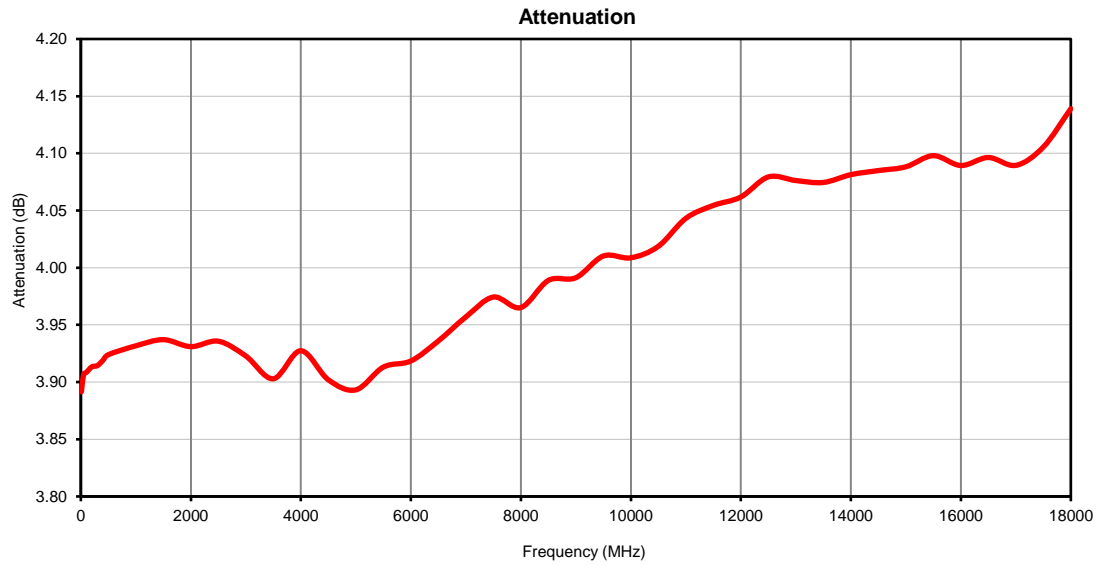

Outline Dimensions

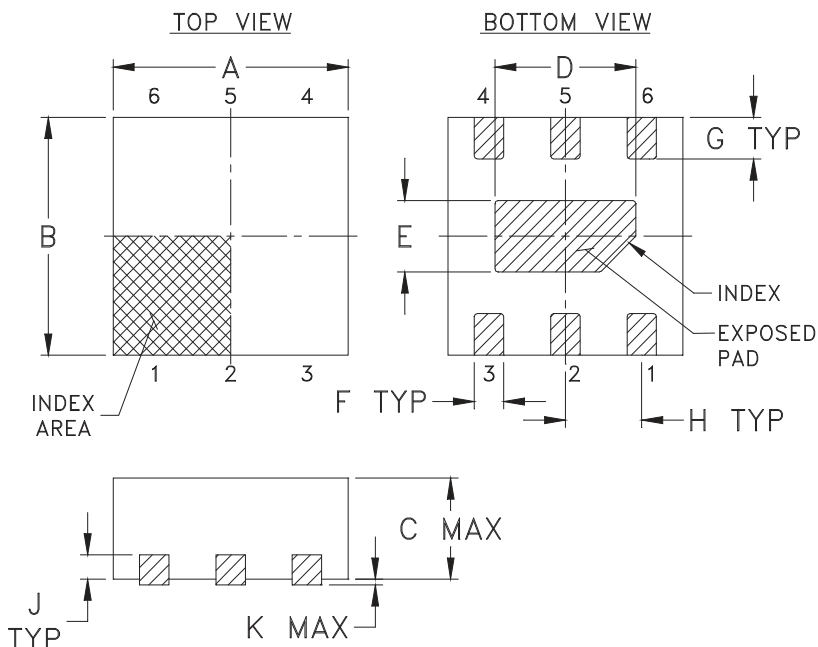

PCB Land Pattern

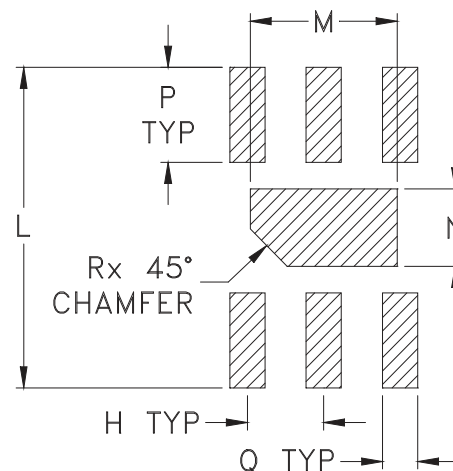

Suggested Layout,
Tolerance to be within ± 0.002

CASE #.	A	B	C	D	E	F	G	H	J	K	L	M	N	P
MC1630	.079 (2.00)	.079 (2.00)	.031 (.80)	.047 (1.20)	.024 (.60)	.010 (.25)	.014 (.35)	.026 (.65)	.008 (.20)	.002 (.05)	.106 (2.70)	.049 (1.25)	.026 (.65)	.031 (.80)

CASE #.	Q	R	WT, GRAM
MC1630	.012 (.30)	.012 (.30)	.006

Dimensions are in inches (mm). Tolerances: 2 Pl. $\pm .01$; 3 Pl. $\pm .005$

Notes:

- Case material: Plastic.
- Termination finish:
For RoHS Case Styles: Matte Tin plate. All models, (+) suffix.
- Lead #1 identifier shall be located in the cross-hatched area shown.
Identifier may be either a molded or marked feature.

Tape & Reel Packaging TR-F108

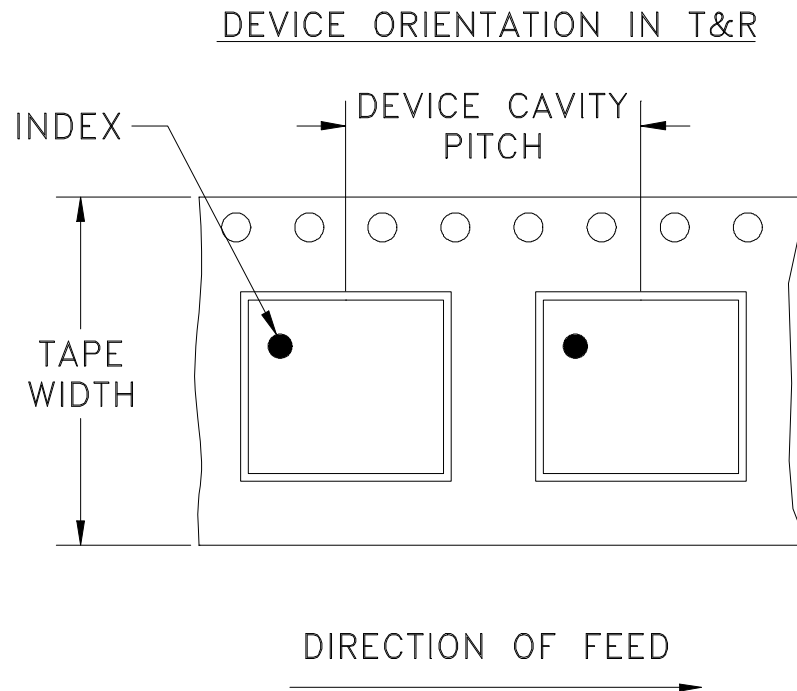

Tape Width, mm	Device Cavity Pitch, mm	Reel Size, inches	Devices per Reel	
12	4	7	Small quantity standards	20
				50
				100
				200
				500
				1000
		7	Standard	2000
				3000

Note: Please Consult individual data sheet to determine device per reel availability

Mini-Circuits carrier tape materials provide protection from ESD (Electro-Static Discharge) during handling and transportation. Tapes are static dissipative and comply with industry standards EIA-481/EIA-541.

Go to: www.minicircuits.com/pages/pdfs/tape.pdf

Mini-Circuits®

INTERNET <http://www.minicircuits.com>

P.O. Box 350166, Brooklyn, New York 11235-0003 (718) 934-4500 Fax (718) 332-4661

Distribution Centers NORTH AMERICA 800-654-7949 • 417-335-5935 • Fax 417-335-5945 • EUROPE 44-1252-832600 • Fax 44-1252-837010

Mini-Circuits ISO 9001 & ISO 14001 Certified

THIRD ANGLE PROJECTION

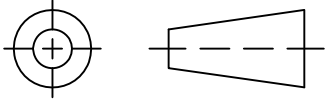

REVISIONS

REV	ECN No.	DESCRIPTION	DATE	DR	AUTH
OR	M167874	NEW RELEASE	05/17/18	ITG	RS

SUGGESTED MOUNTING CONFIGURATION
FOR MC1630-1 CASE STYLE, "06AF04" PIN CODE

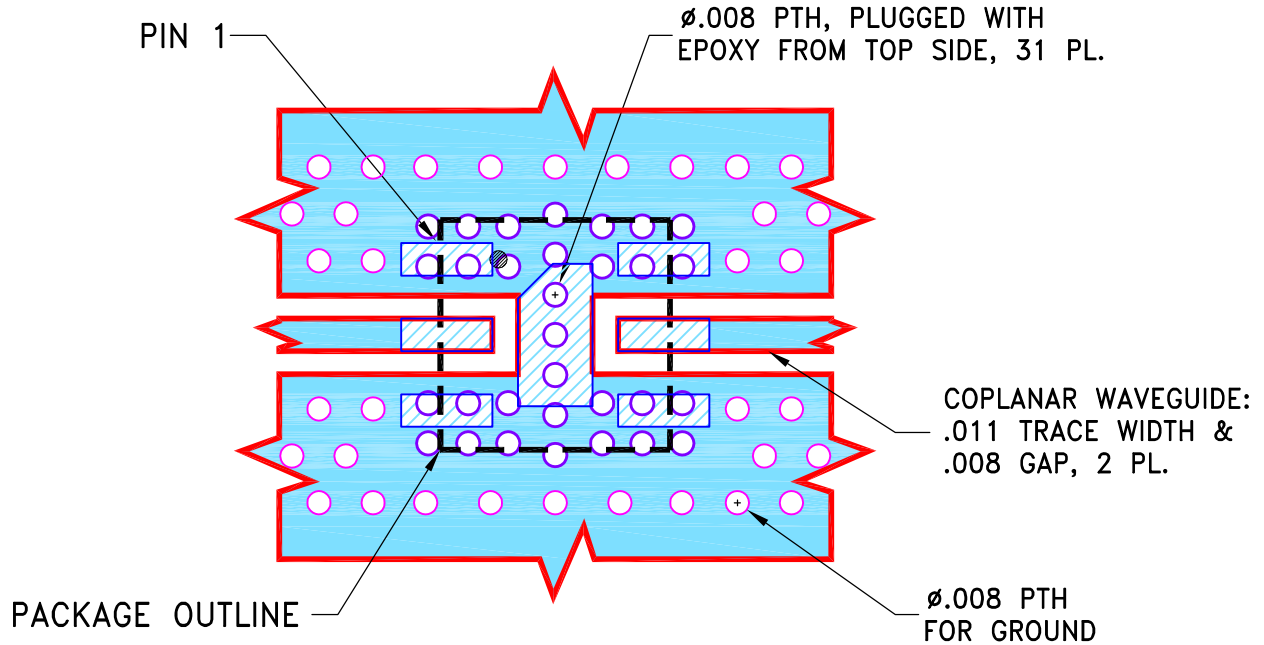

NOTES:

- TRACE WIDTH & GAP PARAMETERS ARE SHOWN FOR ROGERS R04350B WITH DIELECTRIC THICKNESS $.0066 \pm .0007$. COPPER: 1/2 OZ. EACH SIDE. FOR OTHER MATERIALS TRACE WIDTH & GAP MAY NEED TO BE MODIFIED.
- BOTTOM SIDE OF THE PCB IS CONTINUOUS GROUND PLANE.



DENOTES PCB COPPER LAYOUT WITH SMOBC (SOLDER MASK OVER BARE COPPER).

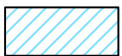

DENOTES COPPER LAND PATTERN FREE OF SOLDER MASK.

UNLESS OTHERWISE SPECIFIED	INITIALS	DATE
DIMENSIONS ARE IN INCHES TOLERANCES ON: 2 PL DECIMALS ± 3 PL DECIMALS ± .005 ANGLES ± FRACTIONS ±	DRAWN	ITG 05/11/18
	CHECKED	GF 05/17/18
	APPROVED	RS 05/17/18



Mini-Circuits®

13 Neptune Avenue
 Brooklyn NY 11235

PL, 06AF04, MC1630-1, TB-934-NC+

Mini-Circuits®
 THIS DOCUMENT AND ITS CONTENTS ARE THE PROPERTY OF MINI-CIRCUITS. EXCEPT FOR USE EXPRESSLY GRANTED, IN WRITING, TO ITS VENDORS, VENDEE AND THE UNITED STATES GOVERNMENT, MINI-CIRCUITS RESERVES ALL PROPRIETARY DESIGN, USE, MANUFACTURING AND REPRODUCTION RIGHTS THERETO. THESE CONTENTS SHALL NOT BE USED, DUPLICATED OR DISCLOSED TO ANY OUTSIDE PARTY, IN WHOLE OR IN PART, WITHOUT WRITTEN PERMISSION OF MINI-CIRCUITS.

SIZE A	CODE IDENT 15542	DRAWING NO: 98-PL-586	REV: OR
FILE: 98PL586	SCALE: 15:1	SHEET: 1 OF 1	

Evaluation Board and Circuit

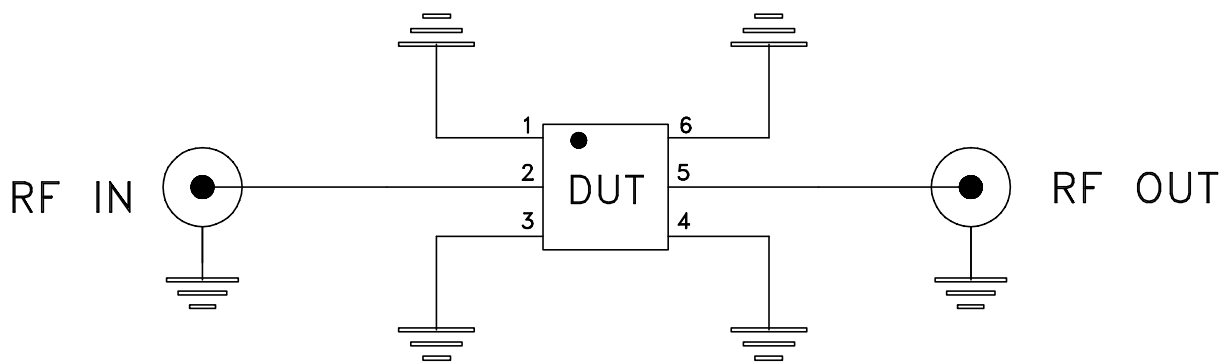
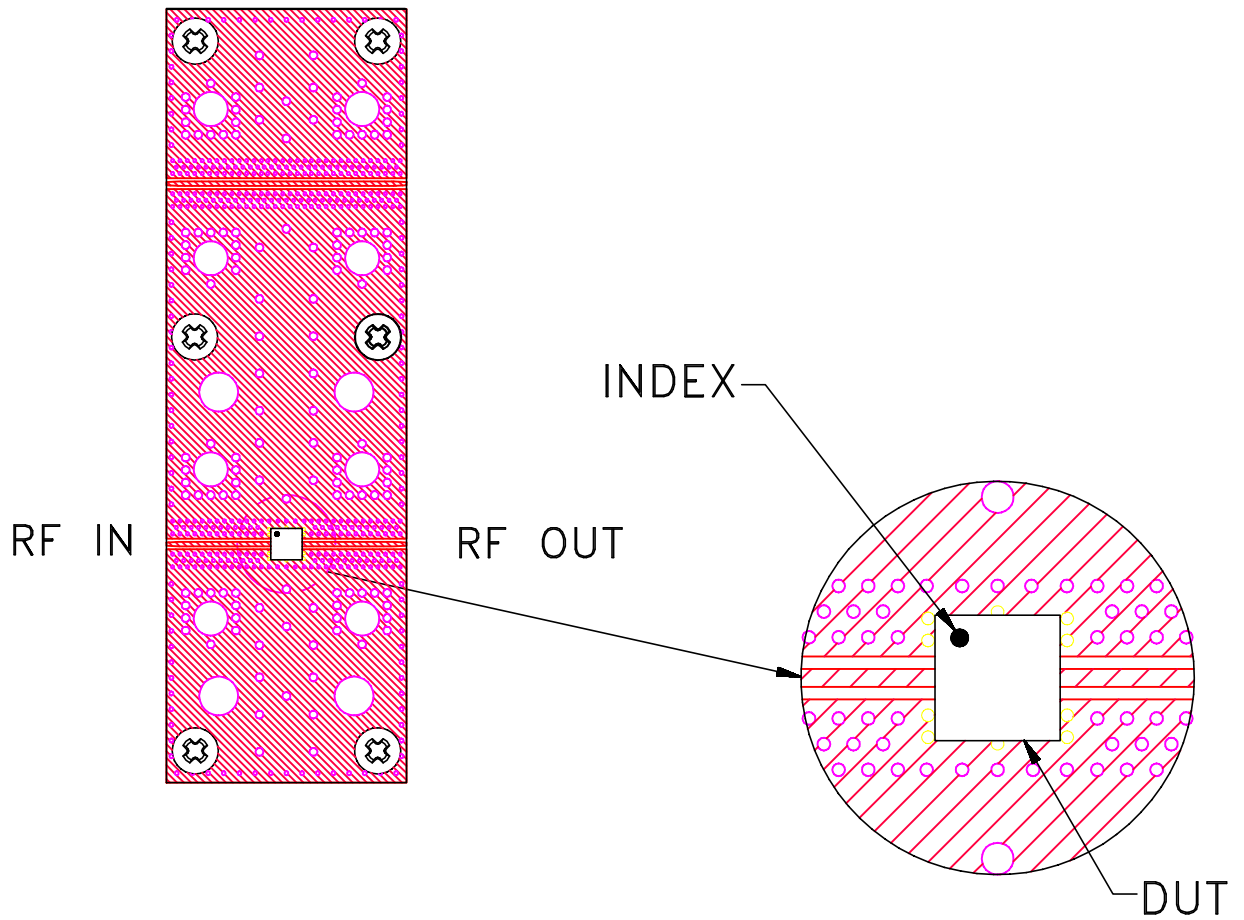

Schematic Diagram

Note:

1. PCB Material: R04350 or equivalent,
Dielectric Constant=3.5, Thickness=.0066 inch.

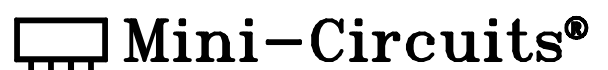

Evaluation Board and Circuit

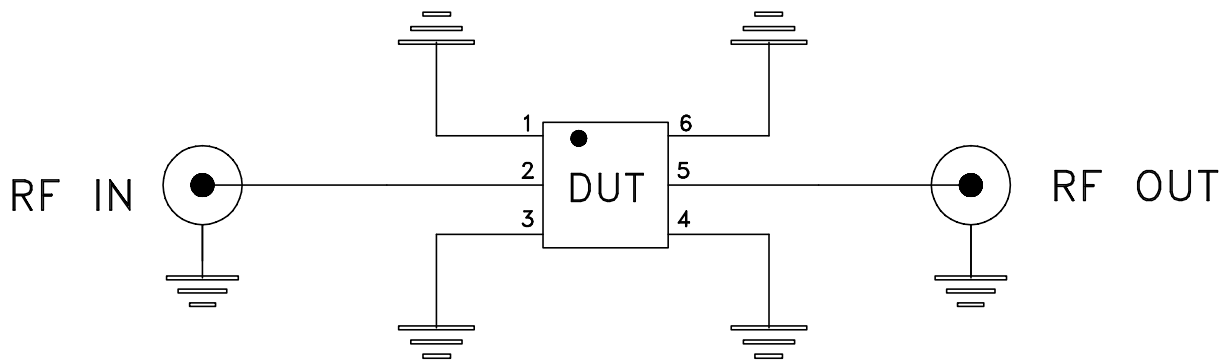
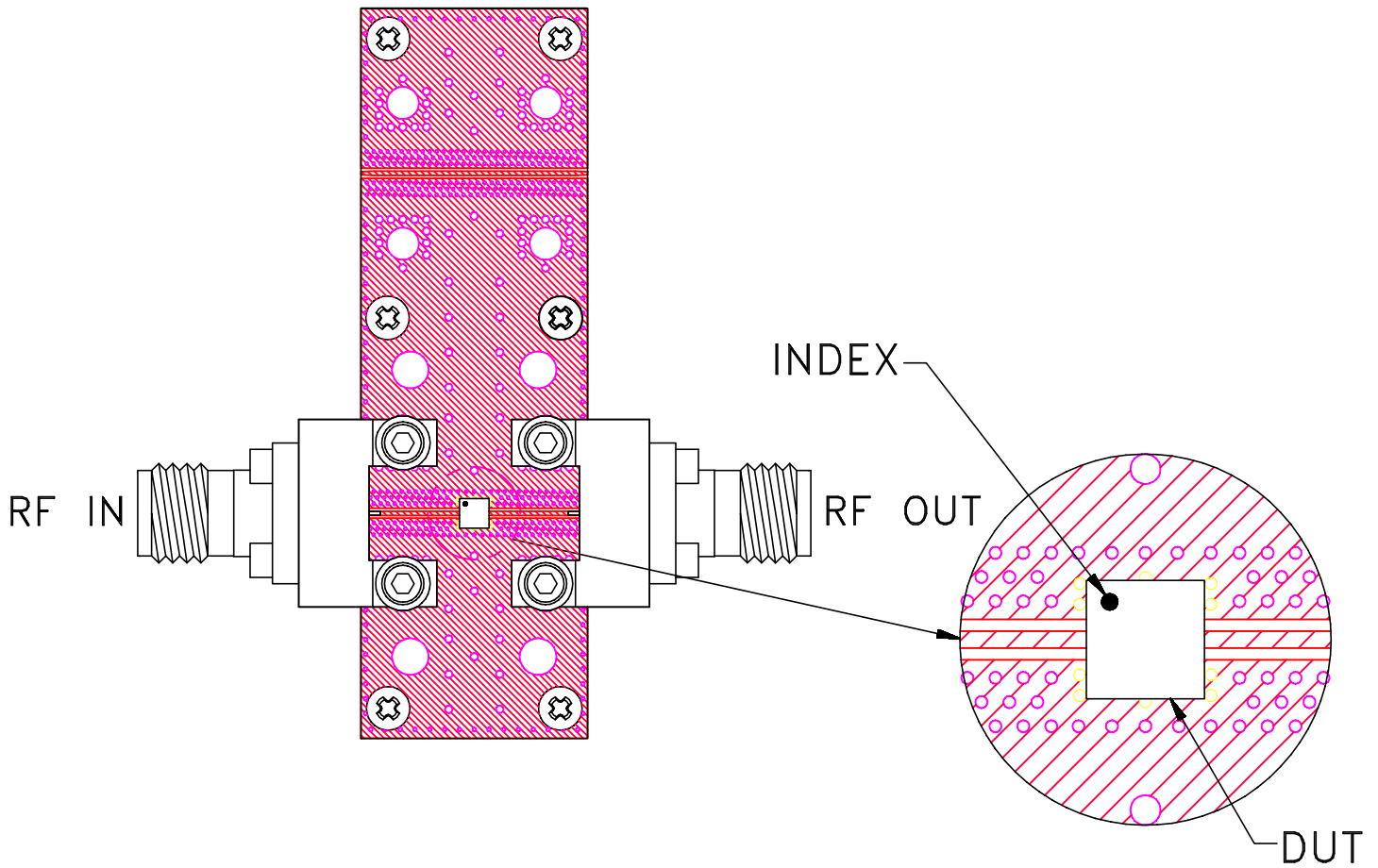

Schematic Diagram

Notes:

1. 50 Ohm 2.40mm Female end launch connectors.
2. PCB Material: R04350 or equivalent,
Dielectric Constant=3.5, Thickness=.0066 inch.

 **Mini-Circuits®**

All Mini-Circuits products are manufactured under exacting quality assurance and control standards, and are capable of meeting published specifications after being subjected to any or all of the following physical and environmental test.

Specification	Test/Inspection Condition	Reference/Spec
Operating Temperature	-40° to 85°C or -45° to 85°C Ambient Environment	Individual Model Data Sheet
Storage Temperature	-55° to 100° C or -65° to 150° Ambient Environment	Individual Model Data Sheet
Thermal Shock	-55° to 100°C, 100 cycles	MIL-STD-202, Method 107, Condition A-3, except +100°C
Mechanical Shock	1.5Kg, 0.5 ms, 5 shock pulses, Y1 direction only	MIL-STD-883, Method 2002, Condition B, except Y1 direction only
Vibration (Variable Frequency)	50g peak	MIL-STD-883, Method 2007, Condition B
Autoclave	15 psig, 100% RH, 121°C, 96 hours	JESD22-A102, Condition C
HAST	130°C, 85% RH, 96 hours	JESD22-A110
Solderability	10X Magnification	J-STD-002, Para 4.2.5, Test S, 95% Coverage
Solder Reflow Heat	Sn-Pb Eutetic Process: 240°C peak Pb-Free Process: 260°C peak	J-STD-020, Table 4-1, 4-2 and 5-2; Figure 5-1
Moisture Sensitivity: Level 1	Bake at 125°C for 24 hours Soak at 85°C/85% RH for 168 hours, Reflow 3 cycles at 260°C peak	J-STD-020
Marking Resistance to Solvents	Isopropyl alcohol + mineral spirits at 25°C; terpene defluxer at 25°C; distilled water + proylene glycol monomethyl ether +	MIL-STD-202, Method 215



All Mini-Circuits products are manufactured under exacting quality assurance and control standards, and are capable of meeting published specifications after being subjected to any or all of the following physical and environmental test.

Specification	Test/Inspection Condition	Reference/Spec
	monoethanolamine at 63°C to 70°C	