

Microwave Precision

# Fixed Attenuator

YAT-SERIES

50Ω Up to 2W DC to 18 GHz

## The Big Deal

- Exceptional Power Handling, Up to 2W
- Wide bandwidth, DC - 18 GHz
- Small Size, 2 mm x 2 mm

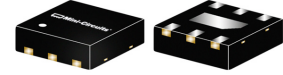

CASE STYLE: MC1630

## Product Overview

YAT attenuators (ROHS compliant) are fixed value, absorptive attenuators fabricated using highly repetitive MMIC processing including thin film resistors on Silicon substrates. YAT attenuator die contain through-wafer Cu metallization vias to realize low thermal resistance and wideband operation. YATs are available with nominal attenuation values of 0 to 10 dB (in 1 dB steps), and 12, 15, 20, and 30 dB. Packaged in tiny 2 mm x 2 mm MCLP™ package fits into tiny spaces.

## Key Features

Feature	Advantages
Wideband operation, DC to 18 GHz	Supports a wide array of applications including wireless cellular, microwave communications, satellite, defense and aerospace, medical broadband and optic applications.
Small Size and simple to use (2 mm x 2 mm)	As a single chip solution, the YAT series occupies less board space than a "T" or "Pi" pad configuration, and ensures repeatable performance over wide frequency ranges.
High Power, Up to 2W	High power handling in a small size package.
Wide range of nominal attenuation values 0 to 10 dB (in 1 dB steps), and 12, 15, 20, and 30 dB	Small increment offering enables circuit designer to change attenuation values without motherboard redesign making the YAT series ideal for select at test application.
MCLP™ Package	Low Inductance, repeatable transitions, excellent thermal path make the YAT series an ideal solution as an alternative to "do it yourself" resistor based attenuators.

### Notes

- A. Performance and quality attributes and conditions not expressly stated in this specification document are intended to be excluded and do not form a part of this specification document.  
B. Electrical specifications and performance data contained in this specification document are based on Mini-Circuit's applicable established test performance criteria and measurement instructions.  
C. The parts covered by this specification document are subject to Mini-Circuits standard limited warranty and terms and conditions (collectively, "Standard Terms"); Purchasers of this part are entitled to the rights and benefits contained therein. For a full statement of the Standard Terms and the exclusive rights and remedies thereunder, please visit Mini-Circuits' website at [www.minicircuits.com/MCLStore/terms.jsp](http://www.minicircuits.com/MCLStore/terms.jsp)



# Microwave Precision Fixed Attenuator

## YAT-2+

50Ω 2W 2dB DC to 18 GHz

### Product Features

- miniature package MCLP™ 2 x 2 mm
- wide bandwidth, DC-18 GHz
- excellent attenuation accuracy & flatness



Generic photo used for illustration purposes only  
CASE STYLE: MC1630

### +RoHS Compliant

The +Suffix identifies RoHS Compliance. See our web site for RoHS Compliance methodologies and qualifications

### Typical Applications

- Cellular
- PCS
- communications
- radar
- defense

### General Description

YAT-2+ is a 2-dB absorptive attenuator fabricated using highly repetitive MMIC process including thin film resistors on GaAs substrate. YAT-2+ attenuator die contains through-wafer Cu metallization vias to realize low thermal resistance and wideband operation. Packaged in tiny 2 mm x 2 mm MCLP™ package fits into tiny spaces.

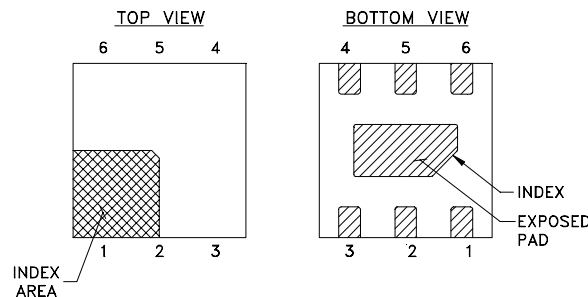

### Pad Description

Function	Pad Number	Description
RF IN	2	RF input pad
RF-OUT	5	RF output pad
GND	1,3,4,6 Bottom Exposed pad	Connected to ground externally

### Notes

- A. Performance and quality attributes and conditions not expressly stated in this specification document are intended to be excluded and do not form a part of this specification document.  
 B. Electrical specifications and performance data contained in this specification document are based on Mini-Circuit's applicable established test performance criteria and measurement instructions.  
 C. The parts covered by this specification document are subject to Mini-Circuits standard limited warranty and terms and conditions (collectively, "Standard Terms"); Purchasers of this part are entitled to the rights and benefits contained therein. For a full statement of the Standard Terms and the exclusive rights and remedies thereunder, please visit Mini-Circuits' website at [www.minicircuits.com/MCLStore/terms.jsp](http://www.minicircuits.com/MCLStore/terms.jsp)



Electrical Specifications<sup>1</sup> at 25°C, 50Ω (CPW)

Parameter	Condition (GHz)	Min.	Typ.	Max.	Unit
Frequency Range		DC	—	18	GHz
Attenuation	0.01	—	2	—	dB
	DC - 5	1.8	2.06	2.25	
	5 - 15	1.9	2.24	2.7	
VSWR	DC - 5	—	1.15	1.25	:1
	5 - 15	—	1.4	1.7	
	15 - 18	—	1.6	1.9	
Input Power <sup>2</sup>	DC - 18	—	—	2.0	W

1. Tested on Mini-Circuits test board TB-621-2+ using coplanar wave guide (CPW) input and output traces (see suggested PCB layout on page 4 of this data sheet)  
 2. RF Power at 25°C case temperature: 2.0 Watt. Derate linearly to 1.0 W at 85°C.

Absolute Maximum Ratings

Operating Case Temperature <sup>3</sup>	-40°C to 85°C
Storage Temperature	-65°C to 150°C
RF Input Power	2W

3. Case is defined as ground lead.  
 Permanent damage may occur if any of these limits are exceeded.

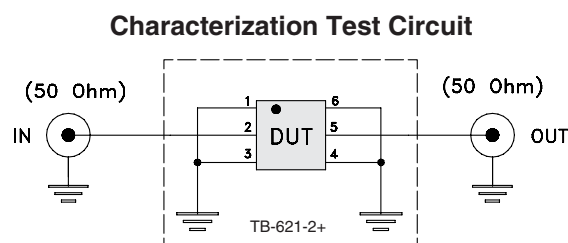
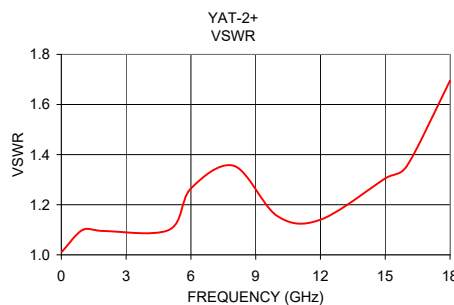
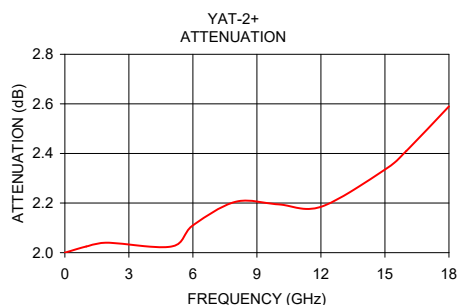

Fig 1. Block diagram of Test Circuit used for characterization, Test board TB-621-2+ Conditions: Attenuation, VSWR: Pin=-10 dBm

Typical Performance Data at 25°C

Frequency (GHz)	Attenuation (dB)	VSWR (:1)
0.001	2.00	1.01
1.0	2.03	1.10
2.0	2.04	1.10
5.0	2.03	1.10
6.0	2.11	1.27
8.0	2.21	1.36
10.0	2.20	1.16
12.0	2.19	1.14
15.0	2.34	1.31
16.0	2.41	1.36
18.0	2.59	1.70



Notes  
 A. Performance and quality attributes and conditions not expressly stated in this specification document are intended to be excluded and do not form a part of this specification document.  
 B. Electrical specifications and performance data contained in this specification document are based on Mini-Circuit's applicable established test performance criteria and measurement instructions.  
 C. The parts covered by this specification document are subject to Mini-Circuits standard limited warranty and terms and conditions (collectively, "Standard Terms"); Purchasers of this part are entitled to the rights and benefits contained therein. For a full statement of the Standard Terms and the exclusive rights and remedies thereunder, please visit Mini-Circuits' website at [www.minicircuits.com/MCLStore/terms.jsp](http://www.minicircuits.com/MCLStore/terms.jsp)



Suggested PCB Layout (PL-349)

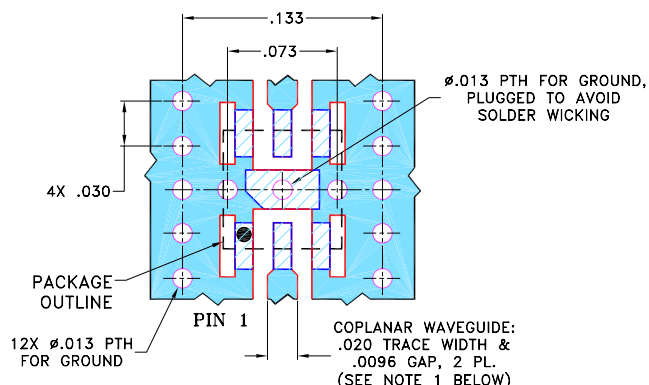

Product Marking

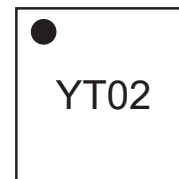

- NOTES: 1. COPLANAR WAVEGUIDE IS SHOWN FOR ROGERS R04350B WITH DIELECTRIC THICKNESS  $.010 \pm .001$ ; COPPER: 1/2 OZ. EACH SIDE. FOR OTHER MATERIALS TRACE WIDTH MAY NEED TO BE MODIFIED.  
 2. BOTTOM SIDE OF THE PCB IS CONTINUOUS GROUND PLANE.

- DENOTES PCB COPPER LAYOUT WITH SMOBC (SOLDER MASK OVER BARE COPPER)
- DENOTES COPPER LAND PATTERN FREE OF SOLDER MASK

Additional Detailed Technical Information	
<i>additional information is available on our dash board. To access this information <a href="#">click here</a></i>	
<b>Performance Data</b>	Data Table
	Swept Graphs
<b>Case Style</b>	MC1630 Plastic package, Terminal finish: Matte Tin Plate
<b>Tape &amp; Reel</b>	F108
<b>Standard quantities available on reel</b>	7" reels with 20, 50, 100, 200, 500, 1K, 2K devices.
<b>Suggested Layout for PCB Design</b>	PL-349
<b>Evaluation Board</b>	TB-621-2+
<b>Environmental Ratings</b>	ENV08T1

**ESD Rating**

Human Body Model (HBM): 250V, Class 1A (JESD22-A114)

Machine Model (MM): 200V, Class B (JESD22-A115)

**MSL Rating**

Moisture Sensitivity: MSL1 in accordance with IPC/JEDEC J-STD-020D

**Notes**

- A. Performance and quality attributes and conditions not expressly stated in this specification document are intended to be excluded and do not form a part of this specification document.
- B. Electrical specifications and performance data contained in this specification document are based on Mini-Circuit's applicable established test performance criteria and measurement instructions.
- C. The parts covered by this specification document are subject to Mini-Circuits standard limited warranty and conditions (collectively, "Standard Terms"); Purchasers of this part are entitled to the rights and benefits contained therein. For a full statement of the Standard Terms and the exclusive rights and remedies thereunder, please visit Mini-Circuits' website at [www.minicircuits.com/MCLStore/terms.jsp](http://www.minicircuits.com/MCLStore/terms.jsp)



# Fixed Attenuator

# YAT-2+

## Typical Performance Data

FREQUENCY (GHz)	ATTENUATION (dB)	VSWR (:1)
0.001	2.00	1.01
0.002	2.00	1.01
0.004	2.00	1.01
0.006	2.00	1.01
0.008	2.00	1.01
0.010	2.01	1.01
0.020	2.01	1.01
0.040	2.01	1.01
0.060	2.01	1.01
0.080	2.01	1.01
0.100	2.01	1.02
0.200	2.02	1.03
0.400	2.02	1.05
0.600	2.02	1.07
0.800	2.03	1.09
1.000	2.03	1.10
1.200	2.03	1.11
1.400	2.03	1.11
1.600	2.04	1.11
1.800	2.04	1.11
2.000	2.04	1.10
2.200	2.05	1.08
2.400	2.05	1.07
2.600	2.05	1.06
2.800	2.05	1.05
3.000	2.05	1.04
3.200	2.04	1.03
3.400	2.04	1.03
3.600	2.03	1.02
3.800	2.03	1.02
4.000	2.02	1.02
4.200	2.02	1.03
4.400	2.01	1.04
4.600	2.01	1.06
4.800	2.02	1.08
5.000	2.03	1.10
5.200	2.04	1.13
5.400	2.05	1.16
5.600	2.07	1.20
5.800	2.09	1.23
6.000	2.11	1.27
7.000	2.20	1.39
8.000	2.21	1.36
9.000	2.20	1.24
10.000	2.20	1.16
11.000	2.18	1.13
12.000	2.19	1.14
13.000	2.18	1.16
14.000	2.25	1.22
15.000	2.34	1.31
16.000	2.41	1.36
17.000	2.51	1.46
18.000	2.59	1.70



P.O. Box 350166, Brooklyn, New York 11235-0003 (718) 934-4500 • Fax (718) 332-4661 For detailed performance specs & shopping online see Mini-Circuits web site



The Design Engineers Search Engine Provides ACTUAL Data Instantly From MINI-CIRCUITS At: [www.minicircuits.com](http://www.minicircuits.com)

IF/RF MICROWAVE COMPONENTS

REV. OR  
YAT-2+  
2/26/2013  
Page 1 of 1

## Typical Performance Curves

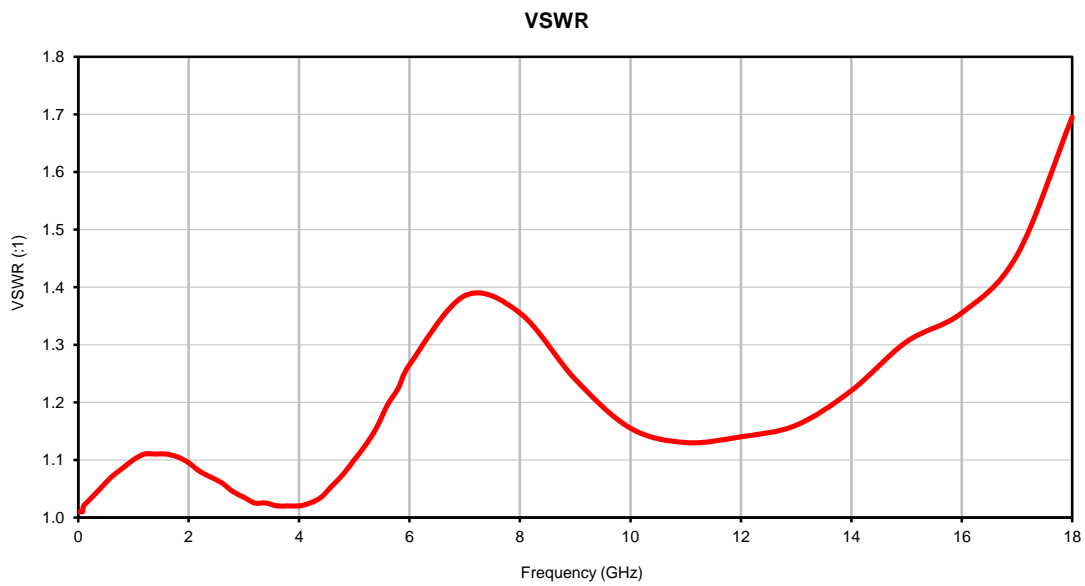
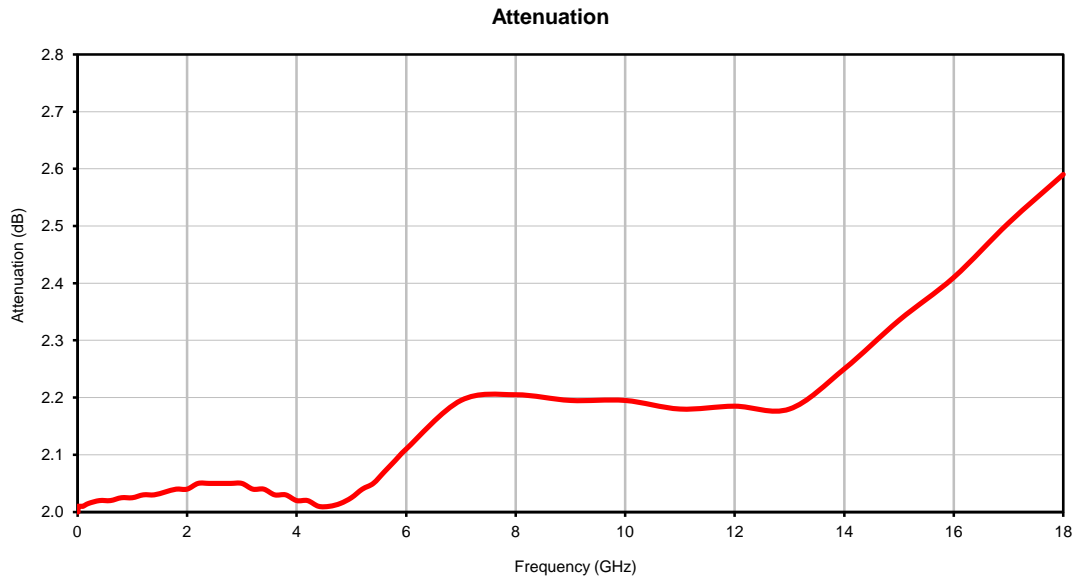

### Outline Dimensions

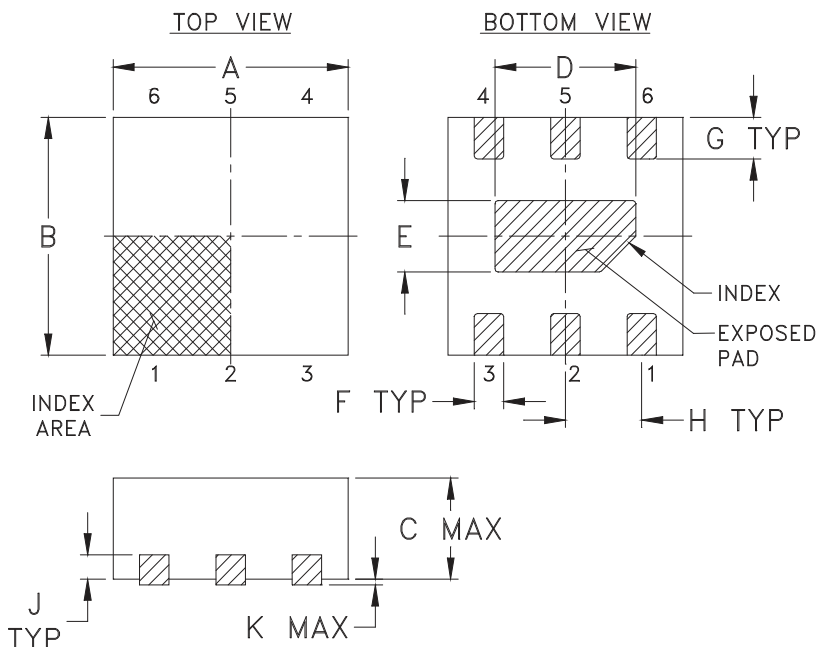

### PCB Land Pattern

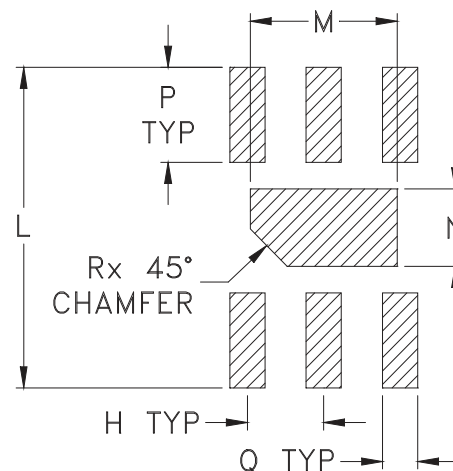

Suggested Layout,  
Tolerance to be within  $\pm 0.002$

CASE #.	A	B	C	D	E	F	G	H	J	K	L	M	N	P
MC1630	.079 (2.00)	.079 (2.00)	.031 (.80)	.047 (1.20)	.024 (.60)	.010 (.25)	.014 (.35)	.026 (.65)	.008 (.20)	.002 (.05)	.106 (2.70)	.049 (1.25)	.026 (.65)	.031 (.80)

CASE #.	Q	R	WT, GRAM
MC1630	.012 (.30)	.012 (.30)	.006

Dimensions are in inches (mm). Tolerances: 2 Pl.  $\pm .01$ ; 3 Pl.  $\pm .005$

#### Notes:

- Case material: Plastic.
- Termination finish:  
For RoHS Case Styles: Matte Tin plate. All models, (+) suffix.
- Lead #1 identifier shall be located in the cross-hatched area shown.  
Identifier may be either a molded or marked feature.

# Tape & Reel Packaging TR-F108

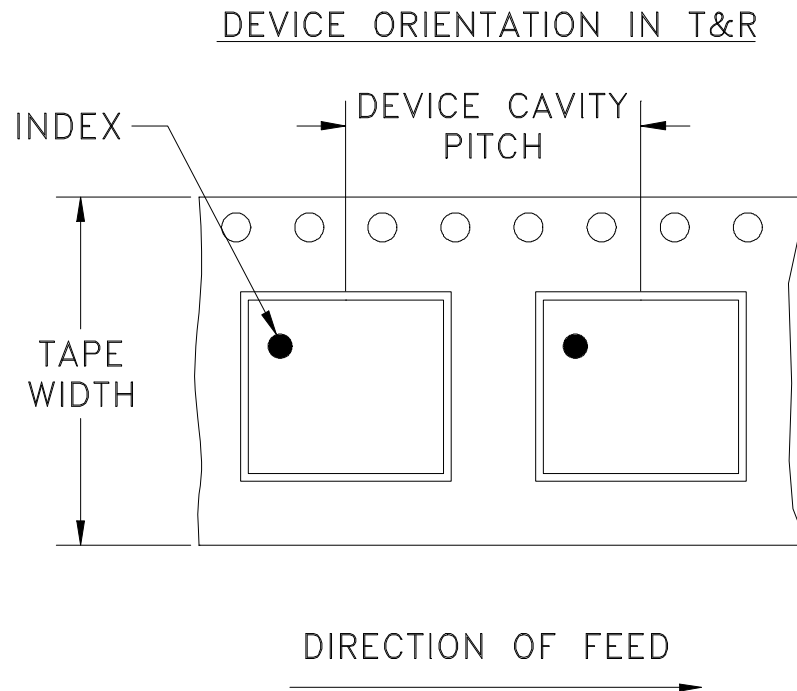

Tape Width, mm	Device Cavity Pitch, mm	Reel Size, inches	Devices per Reel	
12	4	7	Small quantity standards	20
				50
				100
				200
				500
				1000
		7	Standard	2000
				3000

Note: Please Consult individual data sheet to determine device per reel availability

Mini-Circuits carrier tape materials provide protection from ESD (Electro-Static Discharge) during handling and transportation. Tapes are static dissipative and comply with industry standards EIA-481/EIA-541.

Go to: [www.minicircuits.com/pages/pdfs/tape.pdf](http://www.minicircuits.com/pages/pdfs/tape.pdf)

**Mini-Circuits®**

INTERNET <http://www.minicircuits.com>

P.O. Box 350166, Brooklyn, New York 11235-0003 (718) 934-4500 Fax (718) 332-4661

Distribution Centers NORTH AMERICA 800-654-7949 • 417-335-5935 • Fax 417-335-5945 • EUROPE 44-1252-832600 • Fax 44-1252-837010

Mini-Circuits ISO 9001 & ISO 14001 Certified



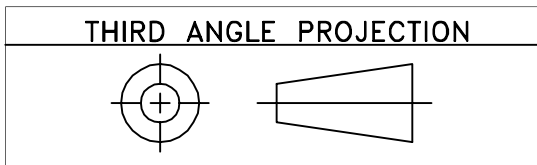

REVISIONS					
REV	ECN No.	DESCRIPTION	DATE	DR	AUTH
OR	M132574	NEW RELEASE	07/07/11	AV	DJ

SUGGESTED MOUNTING CONFIGURATION FOR MC1630 CASE STYLE, "06AF03" PIN CODE

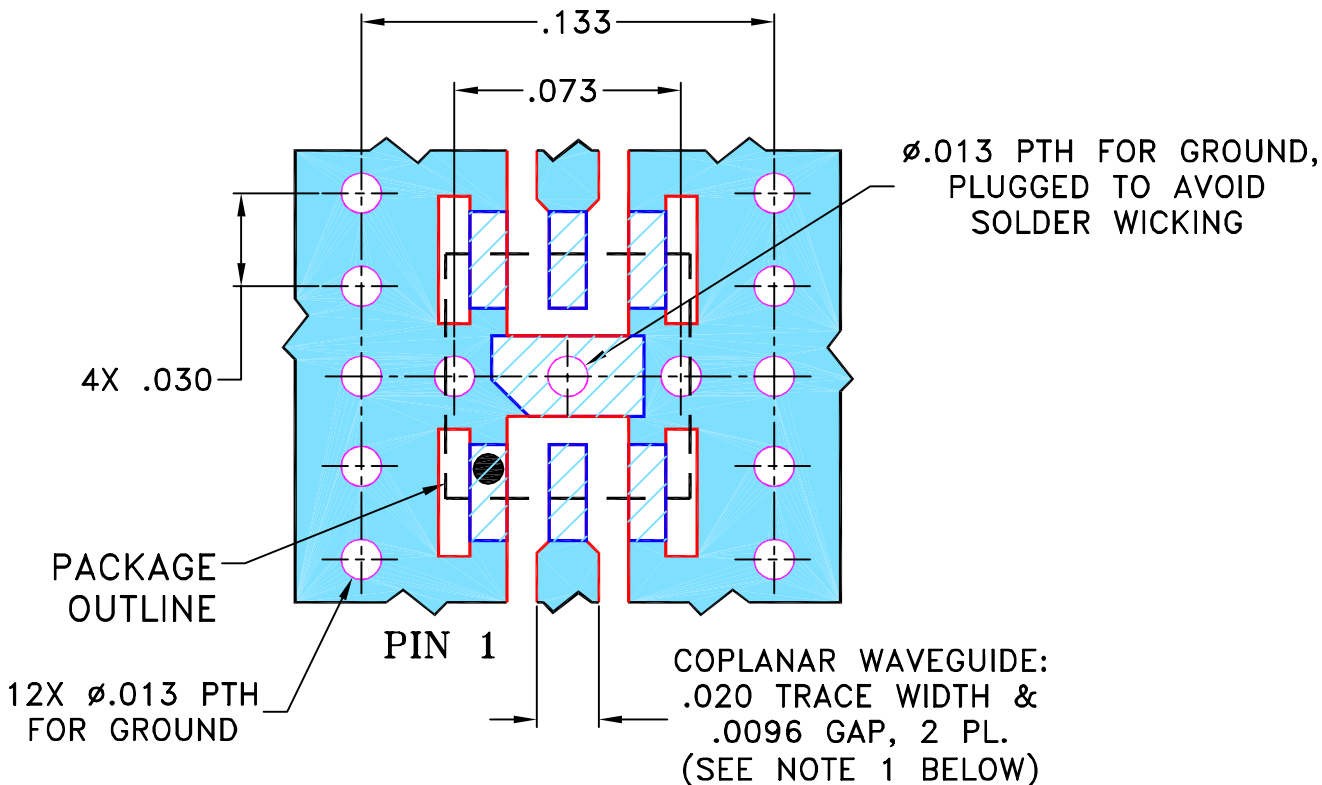

- NOTES: 1. COPLANAR WAVEGUIDE IS SHOWN FOR ROGERS R04350B WITH DIELECTRIC THICKNESS .010" ± .001"; COPPER: 1/2 OZ. EACH SIDE. FOR OTHER MATERIALS TRACE WIDTH MAY NEED TO BE MODIFIED.  
 2. BOTTOM SIDE OF THE PCB IS CONTINUOUS GROUND PLANE.

-  DENOTES PCB COPPER LAYOUT WITH SMOBC (SOLDER MASK OVER BARE COPPER)  
 DENOTES COPPER LAND PATTERN FREE OF SOLDER MASK

UNLESS OTHERWISE SPECIFIED	INITIALS	DATE
DIMENSIONS ARE IN INCHES	DRAWN AV	06/29/11
TOLERANCES ON:	CHECKED IL	07/07/11
2 PL DECIMALS ±	APPROVED DJ	07/07/11
3 PL DECIMALS ± .005		
ANGLES ±		
FRACTIONS ±		

 **Mini-Circuits®** 13 Neptune Avenue  
Brooklyn NY 11235

PL, 06AF03, MC1630, TB-621+

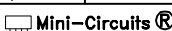
 Mini-Circuits®  
 THIS DOCUMENT AND ITS CONTENTS ARE THE PROPERTY OF MINI-CIRCUITS. EXCEPT FOR USE EXPRESSLY GRANTED, IN WRITING, TO ITS VENDORS, VENDEE AND THE UNITED STATES GOVERNMENT, MINI-CIRCUITS RESERVES ALL PROPRIETARY DESIGN, USE, MANUFACTURING AND REPRODUCTION RIGHTS THERETO. THESE CONTENTS SHALL NOT BE USED, DUPLICATED OR DISCLOSED TO ANY OUTSIDE PARTY, IN WHOLE OR IN PART, WITHOUT WRITTEN PERMISSION OF MINI-CIRCUITS.

ASHEETA1.DWG REV:A DATE:01/12/95

SIZE	CODE IDENT	DRAWING NO:	REV:
A	15542	98-PL-349	OR
FILE:	98PL349	SCALE: 16:1	SHEET: 1 OF 1

# Evaluation Board and Circuit

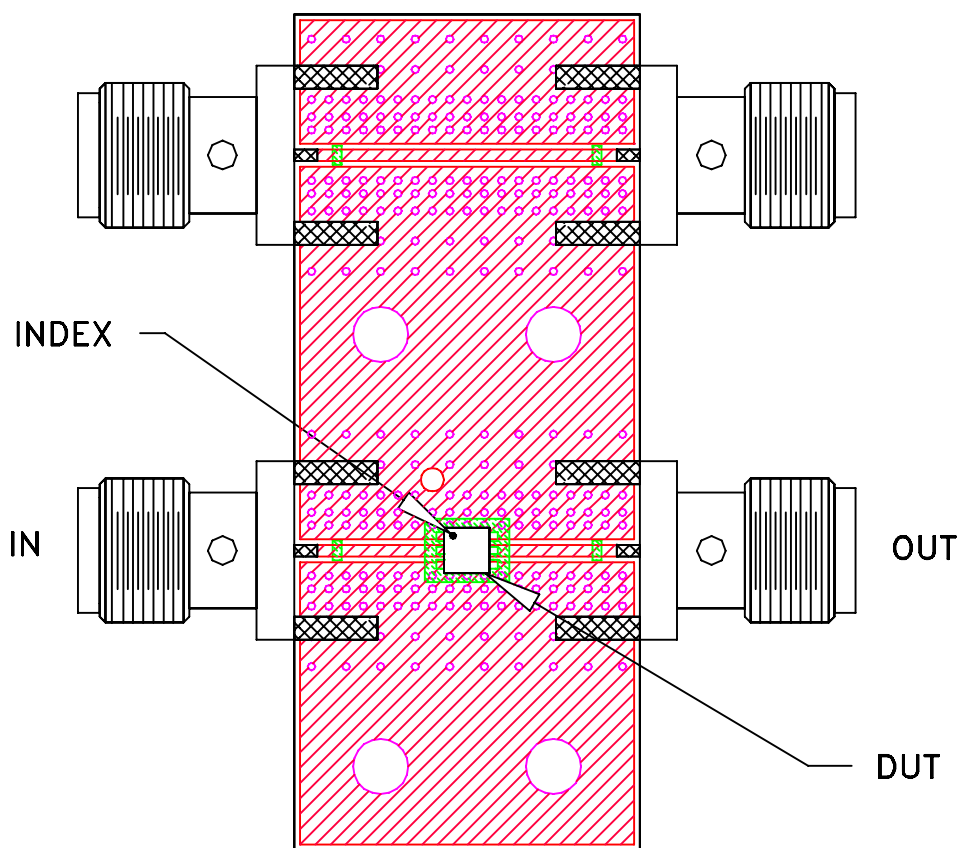

TB-621-2+

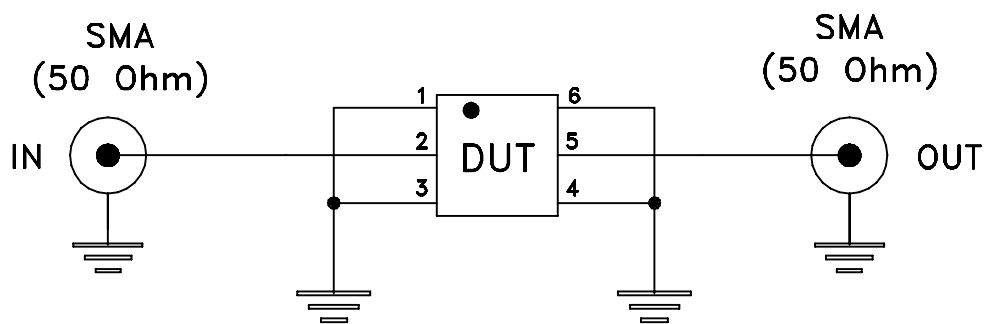

Schematic Diagram

## Notes:

1. 50 Ohm SMA Female connectors.
2. PCB Material: R04350 or equivalent,  
Dielectric Constant=3.5, Thickness=.010 inch.

 **Mini-Circuits®**

All Mini-Circuits products are manufactured under exacting quality assurance and control standards, and are capable of meeting published specifications after being subjected to any or all of the following physical and environmental test.

Specification	Test/Inspection Condition	Reference/Spec
Operating Temperature	-45° to 85°C or -40° to 85°C Ambient Environment	Individual Model Data Sheet
Storage Temperature	-65° to 150° C Ambient Environment	Individual Model Data Sheet
Thermal Shock	-55° to 100°C, 100 cycles	MIL-STD-202, Method 107, Condition A-3, except +100°C
Mechanical Shock	1.5Kg, 0.5 ms, 5 shock pulses, Y1 direction only	MIL-STD-883, Method 2002, Condition B, except Y1 direction only
Vibration (Variable Frequency)	50g peak	MIL-STD-883, Method 2007, Condition B
Autoclave	15 psig, 100% RH, 121°C, 96 hours	JESD22-A102, Condition C
HAST	130°C, 85% RH, 96 hours	JESD22-A110
Solderability	10X Magnification	J-STD-002, Para 4.2.5, Test S, 95% Coverage
Solder Reflow Heat	Sn-Pb Eutetic Process: 240°C peak Pb-Free Process: 260°C peak	J-STD-020, Table 4-1, 4-2 and 5-2; Figure 5-1
Moisture Sensitivity: Level 1	Bake at 125°C for 24 hours Soak at 85°C/85% RH for 168 hours, Reflow 3 cycles at 260°C peak	J-STD-020
Marking Resistance to Solvents	Isopropyl alcohol + mineral spirits at 25°C; terpene defluxer at 25°C; distilled water + proylene glycol monomethyl ether +	MIL-STD-202, Method 215



All Mini-Circuits products are manufactured under exacting quality assurance and control standards, and are capable of meeting published specifications after being subjected to any or all of the following physical and environmental test.

Specification	Test/Inspection Condition	Reference/Spec
	monoethanolamine at 63°C to 70°C	