



MMIC REFLECTIONLESS

# Low Pass Filter

## XLF-551+

Mini-Circuits

50Ω DC to 550 MHz

### THE BIG DEAL

- Match to 50Ω in the stop band, eliminates undesired reflections
- Cascadable
- Excellent Power handling
- Temperature sData, up to +105°C
- Small size, 3 x 3 mm
- Protected by US Patent No. 8,392,495

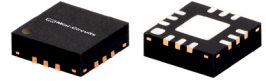

Generic photo used for illustration purposes only

CASE STYLE: DQ1225

**+RoHS Compliant**  
 The +Suffix identifies RoHS Compliance.  
 See our website for methodologies and qualifications

### APPLICATIONS

- Harmonics Rejection
- Wideband Matching
- Transmitters / Receivers

### PRODUCT OVERVIEW

Mini-Circuits' XLF-551+ reflectionless filter employs a novel filter topology which absorbs and terminates stop band signals internally rather than reflecting them back to the source. This new capability enables unique applications for filter circuits beyond those suited to traditional approaches. Traditional filters are reflective in the stop band, sending signals back to the source at 100% of the power level. These reflections interact with neighboring components and often result in inter-modulation and other interferences. Reflectionless filters eliminate stop band reflections, allowing them to be paired with sensitive devices and used in applications that otherwise require circuits such as isolation amplifiers or attenuators.

### KEY FEATURES

Features	Advantages
Reflectionless Technology	Reflectionless filters absorb unwanted signals, preventing reflections back to the source. This reduces generation of additional unwanted signals without the need for extra components like attenuators, improving system dynamic range and saving board space.
50Ω Match in Stopband	Reflectionless filters maintain good impedance matching in the stopband, allowing for integration with high gain, wideband amplifiers without the risk of creating out-of-band instabilities.
Excellent RF Performance Repeatability	Fabricated on a GaAs process, X-series filters are inherently repeaData for large-volume production.
Excellent Stability over temperature	With ±0.3 dB variation over temperature, is ideal for use in wide temperature range applications without the need for additional temperature compensation.
Excellent Power Handling in a Compact Package	High power handling extends the usability of these filters to the transmit path for inter-stage filtering.

REV. B  
 ECO-020722  
 XLF-551+  
 MCL NY  
 240201





### ELECTRICAL SPECIFICATIONS<sup>1</sup> AT +25°C

Parameter	F#	Frequency (MHz)	Min.	Typ.	Max.	Unit	
Passband	Insertion Loss	DC - F1	DC - 550	—	1.4	1.8	dB
	Frequency Cut-off	F2	770	—	3.0	—	dB
	VSWR	DC - F1	DC - 550	—	1.2	—	:1
Stopband	Rejection	F3 - F4	1140 - 5800	12	15	—	dB
		F4 - F5	5800 - 18500	—	24	—	dB
	VSWR	F3 - F4	1140 - 5800	—	1.2	—	:1
		F4 - F5	5800 - 18500	—	1.6	—	:1

1. Measured on Mini-Circuits Characterization Test Board TB-844-551+

### ABSOLUTE MAXIMUM RATINGS<sup>2</sup>

Parameter	Ratings
Operating Temperature	-55°C to +105°C
Storage Temperature	-65°C to +150°C
RF Power Input, Passband (DC-F1) <sup>3</sup>	2 W at +25°C
RF Power Input, Stopband (F2-F5) <sup>4</sup>	0.2 W at +25°C

- 2. Permanent damage may occur if any of these limits are exceeded.
- 3. Passband rating derates linearly to 1 W at 105°C ambient
- 4. Stopband rating derates linearly to 0.1 W at 105°C ambient

### SPECIFICATION DEFINITION

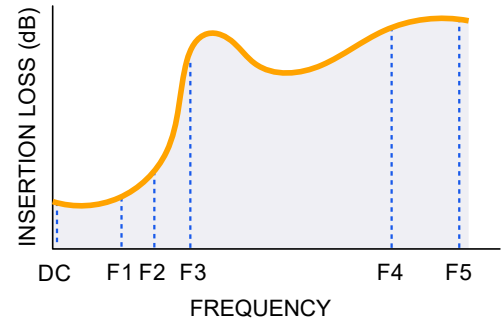



### SIMPLIFIED SCHEMATIC AND PAD DESCRIPTION

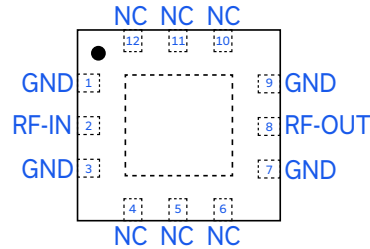
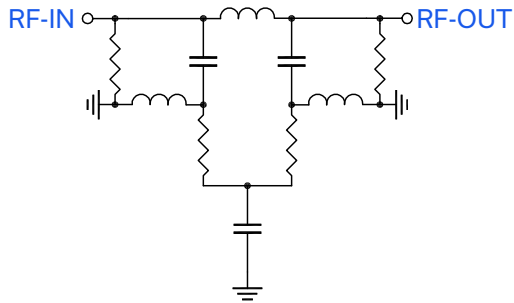

Function	Pad Number	Description
RF-IN	2	RF Input Pad
RF-OUT	8	RF Output Pad
GND	1,3,7,9, Paddle	Connected to ground
NC (GND Externally)	4,5,6,10,11,12	No internal connection

### PRODUCT MARKING

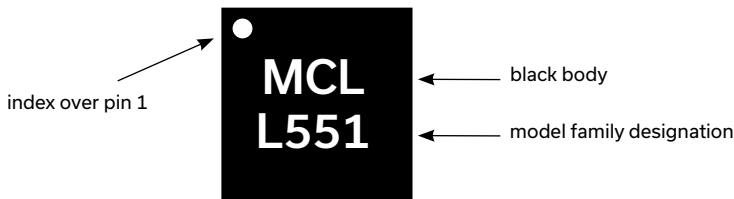

Marking may contain other features or characters for internal lot control



MMIC REFLECTIONLESS

# Low Pass Filter

## XLF-551+

Mini-Circuits

50Ω DC to 550 MHz

### TYPICAL PERFORMANCE DATA AT +25°C

Frequency (MHz)	Insertion Loss (dB)	VSWR (:1)
10	0.81	1.09
50	0.76	1.06
100	0.76	1.07
200	0.80	1.11
550	1.34	1.22
770	3.06	1.18
1140	15.12	1.15
2000	14.94	1.07
3000	15.33	1.09
4500	17.13	1.15
5800	15.30	1.34
7000	17.36	1.21
8500	29.21	1.16
10000	29.02	1.24
11500	27.30	1.51
13000	25.73	1.69
14500	24.32	1.74
16000	23.07	1.69
17500	22.26	1.96
18500	22.74	2.96

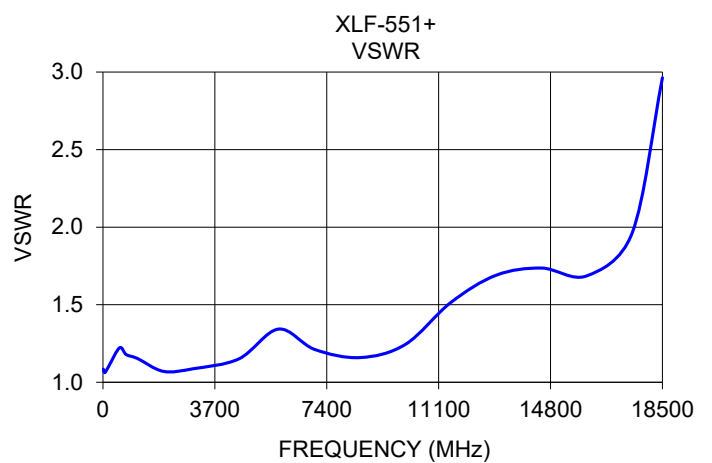
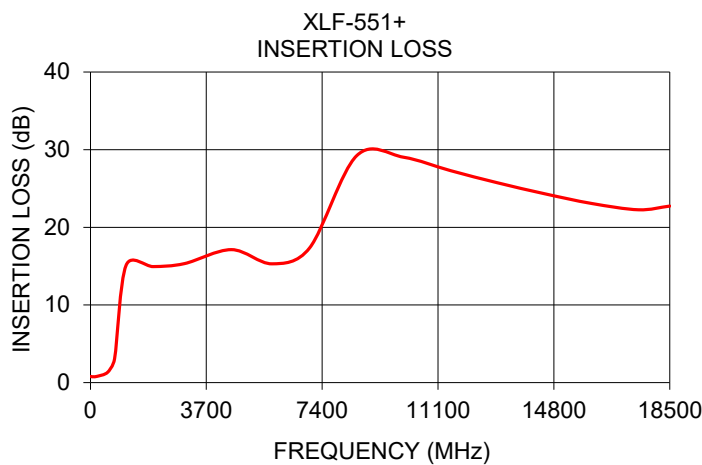



MMIC REFLECTIONLESS

# Low Pass Filter

## XLF-551+



50Ω DC to 550 MHz

ADDITIONAL DETAILED TECHNICAL INFORMATION IS AVAILABLE ON OUR DASH BOARD. TO ACCESS [CLICK HERE](#)

Performance Data & Graphs	Data Graphs S-Parameter (S2P Files) Data Set (.zip file)
Case Style	DQ1225 Plastic package, exposed paddle lead finish: matte-tin
Tape & Reel Standard quantities available on reel	F66 7" reels with 20, 50, 100, 200, 500 ,1000, 2000, 3000 devices
Suggested Layout for PCB Design	PL-451
Evaluation Board	TB-844-551+ (without connectors) TB-844-551C+ (with connectors) B20-118-F1+ Connector sold separately
Environmental Ratings	ENV82

### ESD RATING

Human body model (HBM): Class 1A (250 to <500V) in accordance with ANSI/ESD 5.1-2001

### MSL RATING

Moisture Sensitivity: MSL1 in accordance with IPC/JEDEC J-STD-020D





### REFLECTIONLESS FILTER APPLICATION NOTE

Application Circuit Example: Pairing mixers with reflectionless filters to improve system dynamic range

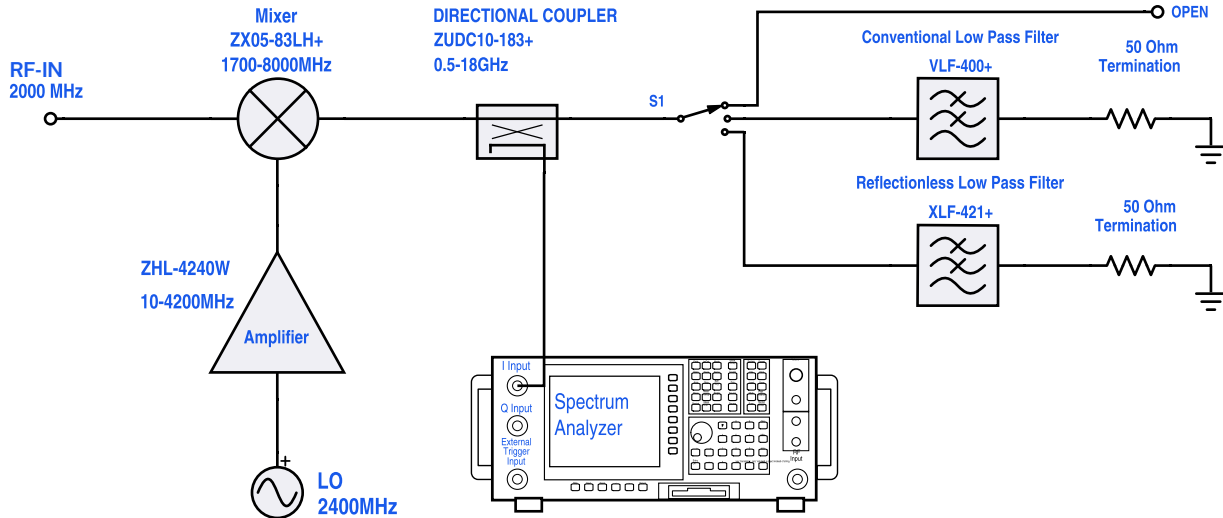

Test block diagram: IF output reflection spectrum with single input frequency

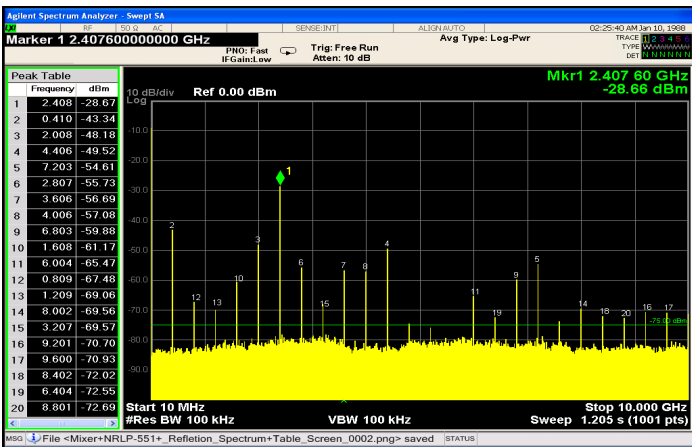

Figure 1. IF output reflection spectrum without filter

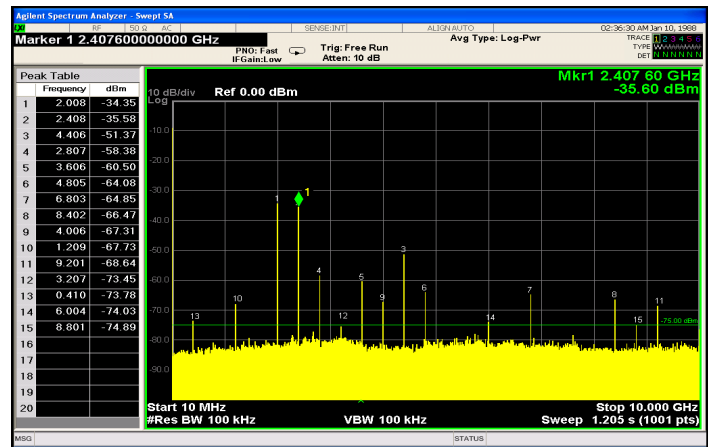
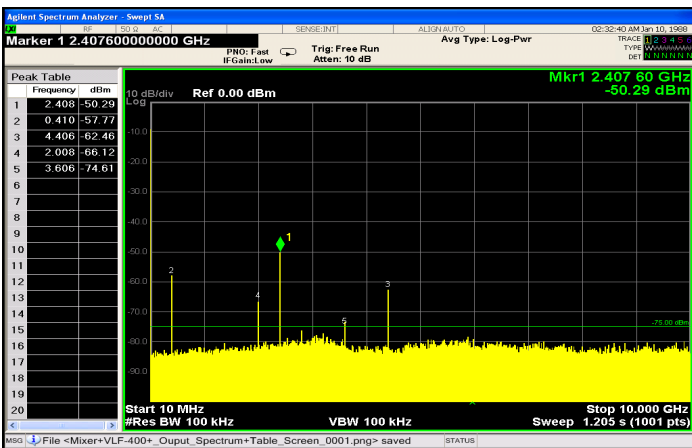

Figure 2. IF output reflection spectrum with conventional filter



An application circuit was assembled to measure the IF reflection spectrum at the output of a mixer when the mixer was paired with a conventional filter versus a reflectionless filter.

While the conventional filter reduces the reflections present when the mixer is used alone (no filter), the reflectionless filter virtually eliminates those reflections altogether.

The reflected signal at marker 1 in the figures above exhibits a reduction of more than 20 dB from -28.7 dBm to -50.3 dBm when the reflectionless filter is used as compared to the conventional filter, thus eliminating unwanted spurious mixing products and improving system dynamic range.

For more information, refer to application note [AN-75-007](#)

- NOTES**
- A. Performance and quality attributes and conditions not expressly stated in this specification document are intended to be excluded and do not form a part of this specification document.
  - B. Electrical specifications and performance data contained in this specification document are based on Mini-Circuit's applicable established test performance criteria and measurement instructions.
  - C. The parts covered by this specification document are subject to Mini-Circuits standard limited warranty and terms and conditions (collectively, "Standard Terms"); Purchasers of this part are entitled to the rights and benefits contained therein. For a full statement of the standard terms and the exclusive rights and remedies thereunder, please visit Mini-Circuits' website at [www.minicircuits.com/MCLStore/terms.jsp](http://www.minicircuits.com/MCLStore/terms.jsp)

Typical Performance Data

FREQ. (MHz)	INSERTION LOSS					GROUP DELAY				
	(dB)					(nsec)				
	@-55°C	@-40°C	@+25°C	@+85°C	@+105°C	@-55°C	@-40°C	@+25°C	@+85°C	@+105°C
10	0.68	0.72	0.80	0.92	0.94	0.31	0.29	0.32	0.28	0.34
50	0.61	0.64	0.76	0.84	0.89	0.29	0.28	0.30	0.29	0.31
100	0.63	0.65	0.76	0.86	0.89	0.28	0.28	0.28	0.28	0.29
120	0.63	0.65	0.77	0.87	0.91	0.28	0.28	0.28	0.29	0.29
140	0.63	0.65	0.77	0.87	0.90	0.28	0.28	0.28	0.28	0.29
160	0.64	0.67	0.80	0.89	0.92	0.28	0.28	0.28	0.29	0.29
180	0.63	0.67	0.80	0.90	0.93	0.28	0.29	0.28	0.29	0.29
200	0.65	0.67	0.79	0.91	0.95	0.29	0.29	0.29	0.29	0.29
220	0.66	0.68	0.82	0.92	0.97	0.29	0.29	0.29	0.29	0.30
240	0.66	0.69	0.83	0.94	0.98	0.29	0.29	0.29	0.29	0.29
260	0.68	0.70	0.84	0.95	0.99	0.29	0.29	0.29	0.29	0.30
280	0.70	0.72	0.86	0.98	1.02	0.29	0.30	0.29	0.30	0.30
300	0.71	0.74	0.87	0.99	1.05	0.30	0.30	0.30	0.30	0.30
320	0.72	0.75	0.89	1.01	1.05	0.30	0.30	0.30	0.30	0.31
340	0.73	0.77	0.91	1.03	1.07	0.30	0.31	0.31	0.31	0.31
360	0.75	0.80	0.92	1.05	1.10	0.31	0.31	0.31	0.31	0.32
380	0.77	0.80	0.96	1.08	1.13	0.32	0.32	0.32	0.32	0.32
400	0.79	0.83	0.99	1.10	1.16	0.32	0.32	0.32	0.33	0.33
420	0.82	0.85	1.01	1.15	1.20	0.33	0.33	0.33	0.33	0.34
440	0.85	0.89	1.04	1.18	1.23	0.34	0.34	0.33	0.34	0.34
460	0.88	0.92	1.09	1.24	1.28	0.34	0.34	0.34	0.34	0.35
480	0.92	0.96	1.12	1.28	1.33	0.35	0.35	0.35	0.35	0.35
500	0.96	1.00	1.18	1.33	1.38	0.36	0.36	0.36	0.36	0.36
520	1.00	1.04	1.23	1.39	1.44	0.37	0.37	0.36	0.37	0.37
550	1.09	1.14	1.34	1.51	1.56	0.38	0.38	0.38	0.38	0.38
580	1.20	1.25	1.45	1.63	1.69	0.40	0.39	0.39	0.40	0.40
600	1.29	1.34	1.55	1.73	1.80	0.41	0.40	0.40	0.40	0.40
610	1.33	1.38	1.60	1.79	1.85	0.41	0.41	0.41	0.41	0.41
620	1.39	1.43	1.66	1.85	1.91	0.42	0.42	0.41	0.41	0.42
640	1.49	1.54	1.78	1.97	2.05	0.43	0.43	0.42	0.42	0.42
660	1.61	1.67	1.91	2.11	2.19	0.44	0.44	0.43	0.43	0.43
680	1.76	1.82	2.06	2.28	2.36	0.45	0.45	0.44	0.44	0.44
700	1.92	1.98	2.24	2.46	2.54	0.46	0.46	0.45	0.45	0.45
720	2.11	2.17	2.44	2.68	2.75	0.47	0.47	0.46	0.46	0.46
740	2.31	2.38	2.66	2.90	2.98	0.48	0.48	0.47	0.46	0.46
760	2.55	2.62	2.91	3.16	3.24	0.49	0.48	0.47	0.47	0.47
770	2.67	2.75	3.04	3.31	3.39	0.49	0.49	0.48	0.47	0.47
780	2.81	2.88	3.20	3.45	3.54	0.49	0.49	0.48	0.47	0.47
800	3.11	3.19	3.50	3.77	3.87	0.50	0.50	0.48	0.48	0.48
820	3.44	3.51	3.84	4.12	4.22	0.50	0.50	0.48	0.48	0.47
840	3.81	3.89	4.23	4.52	4.61	0.50	0.50	0.48	0.47	0.47
860	4.21	4.29	4.64	4.94	5.03	0.50	0.49	0.48	0.47	0.46
880	4.66	4.74	5.10	5.41	5.51	0.49	0.49	0.47	0.46	0.45
900	5.14	5.23	5.60	5.92	6.02	0.48	0.48	0.46	0.45	0.44
1000	8.22	8.33	8.74	9.08	9.17	0.39	0.39	0.36	0.34	0.33
1140	14.60	14.71	15.11	15.42	15.52	0.06	0.05	-0.01	-0.05	-0.06
1200	18.27	18.36	18.68	18.87	18.92	-0.29	-0.30	-0.38	-0.44	-0.46
1300	24.75	24.60	24.05	23.56	23.40	-1.41	-1.39	-1.29	-1.20	-1.17
1400	23.17	23.00	22.37	21.89	21.74	-0.85	-0.82	-0.71	-0.63	-0.61
1500	19.74	19.66	19.40	19.18	19.14	-0.14	-0.14	-0.14	-0.13	-0.13
2000	14.86	14.88	14.95	14.98	15.01	0.10	0.10	0.09	0.09	0.09
2500	14.61	14.65	14.75	14.82	14.86	0.08	0.09	0.08	0.08	0.08
3000	15.16	15.20	15.32	15.41	15.43	0.07	0.07	0.07	0.08	0.08
3500	15.86	15.90	16.04	16.11	16.16	0.07	0.07	0.06	0.07	0.07
4000	16.52	16.54	16.68	16.78	16.81	0.06	0.06	0.06	0.06	0.07
4500	16.94	16.98	17.12	17.21	17.24	0.06	0.06	0.06	0.07	0.07
5000	17.00	17.04	17.16	17.23	17.25	0.06	0.07	0.06	0.07	0.07
5500	16.34	16.37	16.42	16.44	16.45	0.08	0.08	0.09	0.09	0.09
5800	15.29	15.30	15.29	15.23	15.21	0.11	0.11	0.11	0.13	0.13
6000	14.12	14.13	14.06	13.95	13.91	0.14	0.15	0.15	0.19	0.19
7000	15.91	16.16	17.32	18.30	18.61	0.21	0.21	0.18	0.17	0.17
8000	26.83	26.94	27.44	27.82	28.01	0.03	0.03	0.03	0.04	0.05
8500	28.76	28.86	29.24	29.54	29.54	0.04	0.03	0.04	0.04	0.04
9000	29.44	29.46	29.75	29.94	30.06	0.03	0.03	0.03	0.03	0.03
9500	29.33	29.40	29.51	29.67	29.72	0.03	0.02	0.05	0.06	0.04
10000	28.93	28.93	29.10	29.17	29.21	0.05	0.03	0.03	0.04	0.03
12000	26.54	26.57	26.79	26.84	26.89	0.04	0.04	0.03	0.05	0.05
14000	24.49	24.55	24.76	24.88	24.93	0.04	0.03	0.04	0.04	0.04
16000	22.76	22.85	23.06	23.17	23.25	0.04	0.05	0.05	0.05	0.05
18000	21.82	21.92	22.31	22.60	22.74	0.06	0.06	0.05	0.07	0.06
18500	22.05	22.16	22.70	23.11	23.27	0.07	0.07	0.06	0.06	0.07
20000	24.87	25.08	25.91	26.63	26.87	0.06	0.06	0.07	0.07	0.09
22000	19.31	19.44	19.76	19.85	19.85	0.31	0.29	0.25	0.21	0.20
24000	17.53	17.71	18.43	18.89	19.01	0.08	0.08	0.07	0.08	0.08
26000	19.53	19.69	20.33	20.79	20.95	0.04	0.04	0.04	0.04	0.04
28000	20.71	20.88	21.67	22.44	22.70	0.06	0.04	0.04	0.04	0.04
30000	24.81	25.04	26.02	26.69	26.92	0.04	0.04	0.04	0.02	0.04



Typical Performance Data

FREQ. (MHz)	INPUT RETURN LOSS					OUTPUT RETURN LOSS				
	(dB)					(dB)				
	@-55°C	@-40°C	@+25°C	@+85°C	@+105°C	@-55°C	@-40°C	@+25°C	@+85°C	@+105°C
10	31.81	31.43	28.86	26.87	26.19	36.42	34.41	30.92	28.43	27.82
50	34.47	33.37	30.24	27.86	27.32	34.73	33.80	30.69	28.21	27.47
100	31.49	31.11	29.21	27.33	26.81	31.54	31.21	29.15	27.30	26.83
120	30.43	30.05	28.51	26.91	26.40	31.10	30.77	29.03	27.12	26.61
140	29.93	29.47	27.95	26.52	26.05	30.03	29.61	28.01	26.48	26.04
160	28.92	28.58	27.12	25.77	25.34	29.14	28.78	27.26	25.84	25.47
180	28.55	28.16	26.64	25.47	25.06	28.27	27.93	26.55	25.42	25.05
200	27.84	27.48	25.98	24.88	24.61	27.73	27.47	26.07	24.96	24.61
220	27.19	26.79	25.31	24.41	24.06	27.05	26.78	25.47	24.53	24.25
240	26.27	26.00	24.64	23.76	23.55	26.22	25.89	24.62	23.90	23.62
260	26.09	25.76	24.44	23.72	23.43	25.71	25.52	24.27	23.52	23.31
280	25.29	24.99	23.82	23.15	22.91	25.35	25.10	23.92	23.25	23.04
300	24.54	24.40	23.39	22.65	22.49	24.53	24.31	23.38	22.73	22.59
320	24.04	23.88	22.94	22.33	22.10	24.02	23.86	22.98	22.49	22.30
340	23.52	23.37	22.53	21.91	21.77	23.58	23.50	22.72	22.16	21.97
360	22.87	22.72	21.99	21.58	21.38	23.30	23.11	22.39	21.94	21.78
380	22.64	22.47	21.85	21.34	21.16	22.85	22.71	22.07	21.65	21.49
400	22.26	22.13	21.48	21.07	20.97	22.36	22.25	21.62	21.32	21.15
420	21.93	21.75	21.14	20.75	20.62	22.11	22.02	21.41	21.07	20.96
440	21.67	21.50	20.89	20.56	20.43	21.87	21.77	21.15	20.82	20.72
460	21.43	21.26	20.60	20.33	20.19	21.57	21.44	20.88	20.59	20.48
480	21.23	21.08	20.41	20.16	20.07	21.45	21.32	20.74	20.49	20.38
500	21.08	20.99	20.30	20.06	19.92	21.08	20.95	20.38	20.11	20.06
520	21.00	20.87	20.24	19.99	19.89	21.08	20.97	20.41	20.17	20.09
550	20.69	20.59	20.00	19.76	19.67	20.77	20.69	20.17	19.93	19.90
580	20.53	20.40	19.90	19.65	19.59	20.69	20.59	20.10	19.89	19.83
600	20.46	20.40	19.94	19.69	19.65	20.63	20.53	20.09	19.90	19.83
610	20.39	20.32	19.88	19.67	19.59	20.66	20.56	20.12	19.91	19.84
620	20.38	20.30	19.86	19.67	19.61	20.60	20.50	20.11	19.93	19.85
640	20.43	20.35	19.99	19.76	19.71	20.68	20.59	20.17	19.99	19.96
660	20.45	20.39	20.08	19.88	19.79	20.75	20.68	20.30	20.15	20.10
680	20.57	20.50	20.23	20.02	19.95	20.88	20.86	20.51	20.30	20.25
700	20.79	20.73	20.45	20.24	20.20	21.10	21.06	20.75	20.58	20.50
720	21.07	21.04	20.79	20.57	20.52	21.37	21.35	21.06	20.86	20.80
740	21.49	21.42	21.24	21.00	20.93	21.72	21.67	21.41	21.23	21.14
760	21.89	21.83	21.64	21.39	21.33	22.08	22.03	21.85	21.61	21.54
770	22.03	21.99	21.77	21.53	21.47	22.25	22.25	22.04	21.79	21.74
780	22.27	22.26	22.06	21.83	21.75	22.45	22.44	22.25	21.98	21.95
800	22.75	22.76	22.57	22.29	22.20	22.84	22.85	22.68	22.38	22.35
820	23.29	23.29	23.10	22.83	22.75	23.38	23.40	23.25	22.96	22.88
840	23.93	23.91	23.76	23.45	23.35	23.95	23.94	23.78	23.45	23.37
860	24.51	24.46	24.33	23.95	23.89	24.46	24.44	24.28	23.91	23.84
880	25.01	24.99	24.80	24.44	24.34	25.02	24.99	24.82	24.42	24.33
900	25.36	25.38	25.17	24.84	24.73	25.39	25.38	25.17	24.76	24.66
1000	24.81	24.85	24.73	24.60	24.54	25.10	25.13	25.01	24.76	24.67
1140	22.72	22.77	22.86	22.77	22.78	23.09	23.12	23.18	23.09	23.07
1200	22.50	22.54	22.62	22.53	22.46	22.72	22.81	22.86	22.72	22.71
1300	22.76	22.79	22.70	22.49	22.41	22.59	22.66	22.79	22.67	22.60
1400	23.43	23.46	23.20	22.86	22.77	23.00	23.04	23.21	22.99	22.92
1500	24.09	24.10	23.95	23.52	23.35	23.74	23.79	23.86	23.56	23.46
2000	31.48	31.08	29.41	27.96	27.53	29.80	29.64	28.99	27.90	27.48
2500	31.68	31.44	30.62	29.39	28.98	35.15	34.47	32.32	30.74	30.17
3000	27.37	27.39	27.53	27.40	27.36	30.58	30.39	29.40	29.08	28.97
3500	26.04	25.98	25.79	26.07	26.09	27.04	27.01	26.49	26.30	26.19
4000	24.78	24.78	24.68	24.96	24.95	25.11	24.97	24.10	23.85	23.72
4500	23.50	23.42	23.08	22.74	22.67	22.23	22.09	21.53	20.94	20.79
5000	21.62	21.49	20.76	20.26	20.18	19.56	19.47	19.07	18.49	18.34
5500	18.73	18.68	18.29	17.92	17.85	17.05	16.99	16.73	16.39	16.31
5800	17.00	16.94	16.66	16.39	16.33	15.69	15.64	15.45	15.28	15.25
6000	15.74	15.70	15.44	15.27	15.23	14.65	14.63	14.50	14.27	14.43
7000	18.59	18.94	20.33	21.42	21.76	19.16	19.47	20.42	20.84	20.98
8000	21.61	21.71	21.90	22.59	22.99	19.24	19.34	19.65	20.63	20.99
8500	22.26	22.27	22.56	22.80	22.91	20.64	20.67	20.90	21.78	22.13
9000	22.36	22.44	23.07	22.66	22.42	22.34	22.44	23.07	23.14	23.04
9500	20.91	20.98	21.57	21.25	21.02	22.74	22.84	23.91	23.22	22.78
10000	19.22	19.30	19.27	19.13	18.99	21.54	21.57	21.71	21.24	20.91
12000	13.05	13.01	12.83	12.47	12.29	13.38	13.31	12.93	12.48	12.31
14000	11.14	11.18	11.33	11.38	11.46	9.84	9.90	10.10	10.14	10.19
16000	11.27	11.34	11.84	12.09	12.19	9.72	9.79	10.12	10.46	10.57
18000	7.97	7.99	7.93	7.81	7.75	9.74	9.77	9.78	9.65	9.62
18500	6.18	6.19	6.12	5.97	5.90	8.15	8.14	7.84	7.69	7.67
20000	2.40	2.49	2.91	3.23	3.36	2.94	3.03	3.42	3.69	3.78
22000	4.21	4.41	5.26	5.84	6.04	4.38	4.53	5.01	5.58	5.82
24000	5.11	5.14	5.35	5.63	5.79	4.54	4.60	4.82	4.90	4.93
26000	2.88	2.96	3.33	3.55	3.65	2.91	2.99	3.36	3.59	3.70
28000	1.99	2.09	2.46	2.67	2.75	3.08	3.19	3.59	3.75	3.76
30000	0.96	1.06	1.53	1.74	1.80	2.02	2.12	2.24	2.51	2.61





## Typical Performance Curves

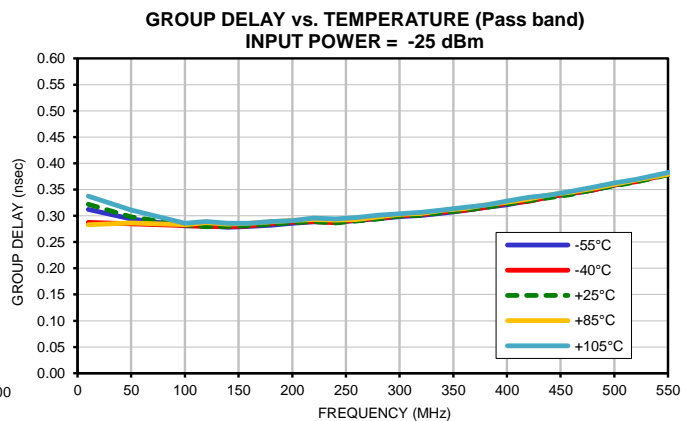
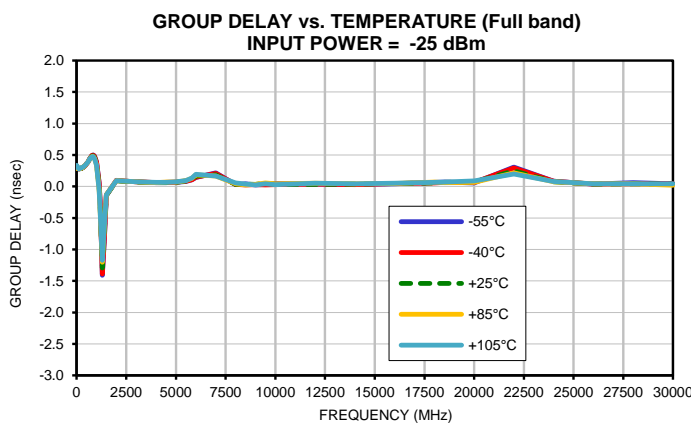
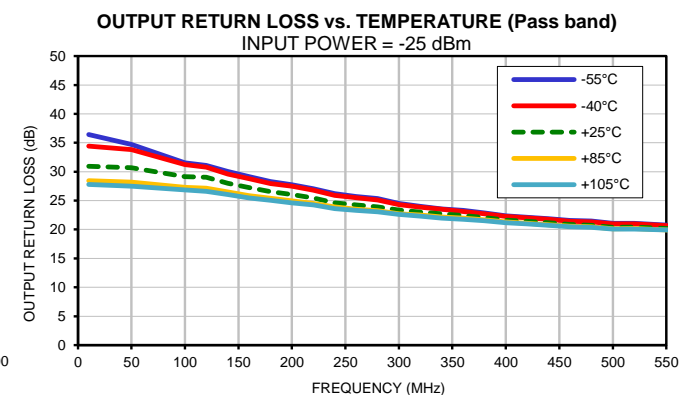
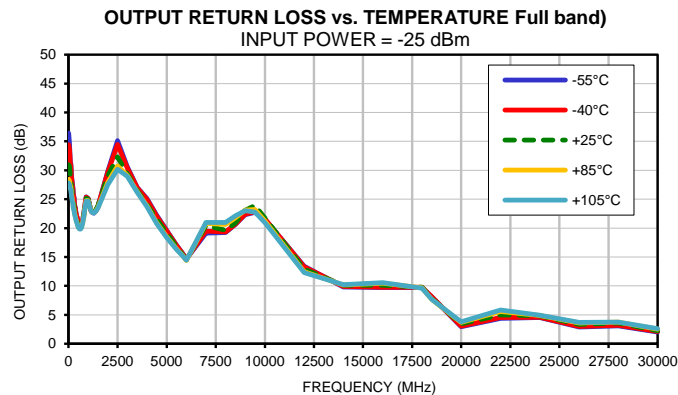
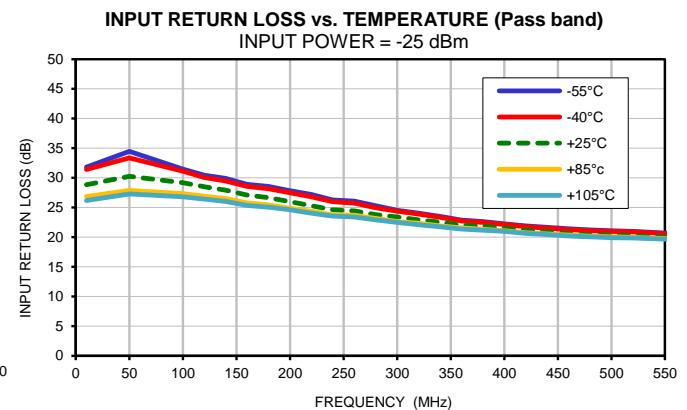
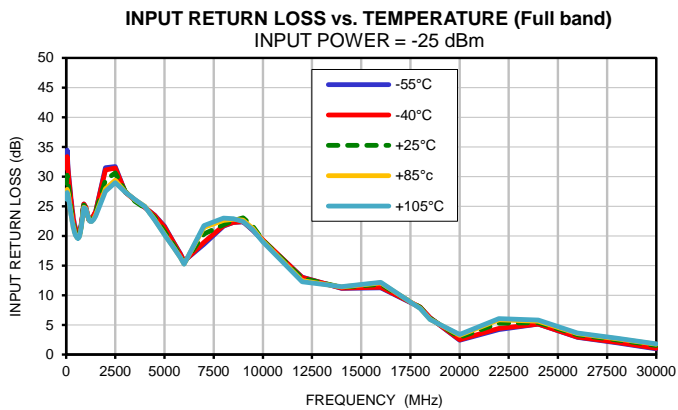
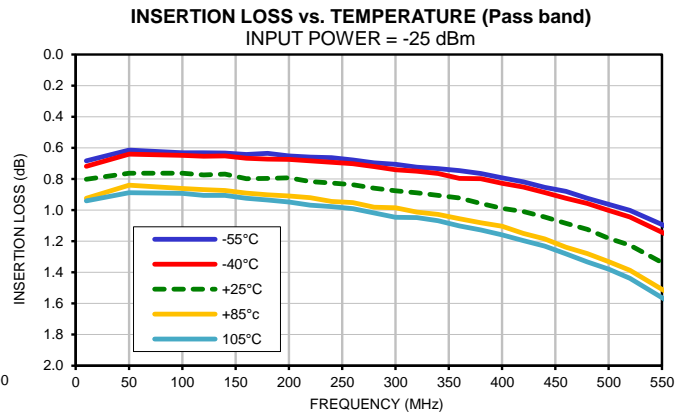
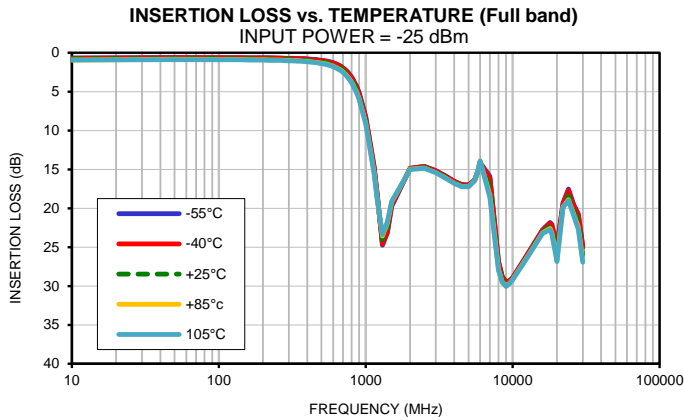

### Outline Dimensions



### PCB Land Pattern

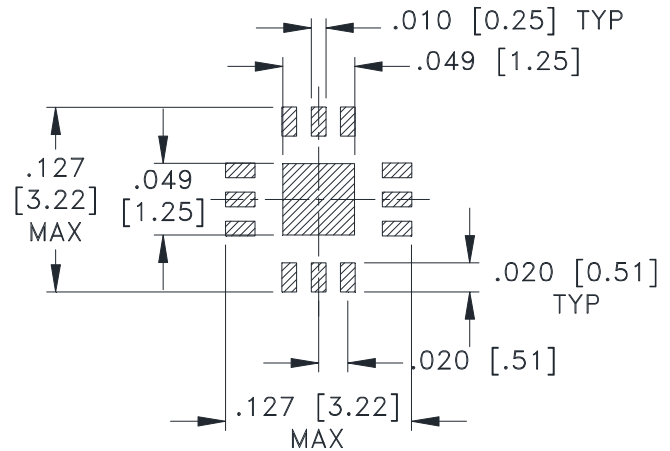

SUGGESTED LAYOUT,  
TOLERANCE TO BE WITHIN  $\pm .002$

**Weight: .02 Grams**

**Dimensions are in inches (mm). Tolerances: 2Pl.  $\pm .01$ ; 3 Pl.  $\pm .004$**

### Notes:

1. Case material: Plastic.
2. Termination finish:
  - For RoHS Case Styles: Tin-Silver alloy plate over Nickel barrier or Matte-Tin. All models, (+) suffix. See Data sheet.
  - For RoHS-5 Case Styles: Tin-Lead plate. All models, no (+) suffix.

**Mini-Circuits®**

Distribution Centers NORTH AMERICA 800-654-7949 • 417-335-5935 • Fax 417-335-5945 • EUROPE 44-1252-832600 • Fax 44-1252-837010

Mini-Circuits ISO 9001 & ISO 14001 Certified

INTERNET <http://www.minicircuits.com>

P.O. Box 350166, Brooklyn, New York 11235-0003 (718) 934-4500 Fax (718) 332-4661

# Tape & Reel Packaging TR-F66



Tape Width, mm	Device Cavity Pitch, mm	Reel Size, inches	Devices per Reel see note	
8	4	7	Small quantity standard	20
				50
				100
				200
				500
		7	Standard	1000, 2000, 3000

Note: Please consult individual model data sheet to determine device per reel availability.

Mini-Circuits carrier tape materials provide protection from ESD (Electro-Static Discharge) during handling and transportation. Tapes are static dissipative and comply with industry standards EIA-481/EIA-541.

Go to: [www.minicircuits.com/pages/pdfs/tape.pdf](http://www.minicircuits.com/pages/pdfs/tape.pdf)

**Mini-Circuits®**

INTERNET <http://www.minicircuits.com>

P.O. Box 350166, Brooklyn, New York 11235-0003 (718) 934-4500 Fax (718) 332-4661

Distribution Centers NORTH AMERICA 800-654-7949 • 417-335-5935 • Fax 417-335-5945 • EUROPE 44-1252-832600 • Fax 44-1252-837010

Mini-Circuits ISO 9001 & ISO 14001 Certified

THIRD ANGLE PROJECTION



REVISIONS

REV	ECN No.	DESCRIPTION	DATE	DR	AUTH
OR	M152656	NEW RELEASE	09/11/15	ITG	MY

SUGGESTED MOUNTING CONFIGURATION  
FOR DQ1225 CASE STYLE, "12FL02" PIN CODE

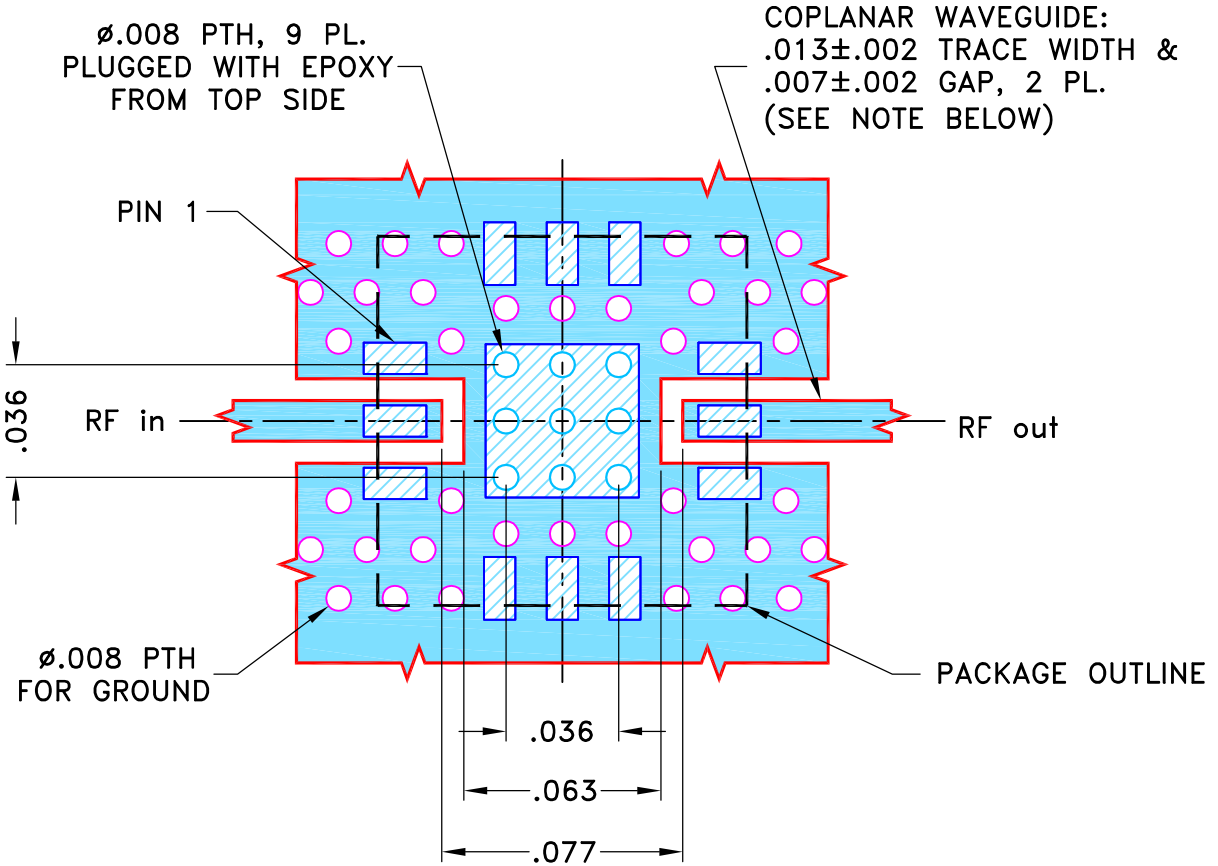

**NOTES:**

- TRACE WIDTH PARAMETERS ARE SHOWN FOR ROGERS R04350B WITH DIELECTRIC THICKNESS  $.0066 \pm .0007$ ". COPPER: 1/2 OZ. EACH SIDE. FOR OTHER MATERIALS TRACE WIDTH AND GAP MAY NEED TO BE MODIFIED.
- BOTTOM SIDE OF THE PCB IS CONTINUOUS GROUND PLANE.

- DENOTES PCB COPPER LAYOUT WITH SMOBC (SOLDER MASK OVER BARE COPPER).
- DENOTES COPPER LAND PATTERN FREE OF SOLDER MASK.

UNLESS OTHERWISE SPECIFIED	INITIALS		DATE
DIMENSIONS ARE IN INCHES TOLERANCES ON: 2 PL DECIMALS ± 3 PL DECIMALS ± .005 ANGLES ± FRACTIONS ±	DRAWN	ITG	09/10/15
	CHECKED	GF	09/11/15
	APPROVED	MY	09/11/15

**Mini-Circuits<sup>®</sup>** 13 Neptune Avenue  
 Brooklyn NY 11235

PL, 12FL02, DQ1225, TB-844+

Mini-Circuits<sup>®</sup>  
 THIS DOCUMENT AND ITS CONTENTS ARE THE PROPERTY OF MINI-CIRCUITS. EXCEPT FOR USE EXPRESSLY GRANTED, IN WRITING, TO ITS VENDORS, VENDEE AND THE UNITED STATES GOVERNMENT, MINI-CIRCUITS RESERVES ALL PROPRIETARY DESIGN, USE, MANUFACTURING AND REPRODUCTION RIGHTS THERETO. THESE CONTENTS SHALL NOT BE USED, DUPLICATED OR DISCLOSED TO ANY OUTSIDE PARTY, IN WHOLE OR IN PART, WITHOUT WRITTEN PERMISSION OF MINI-CIRCUITS.

SIZE A	CODE IDENT 15542	DRAWING NO: 98-PL-451	REV: OR
FILE: 98PL451	SCALE: 16:1	SHEET: 1 OF 1	

# Evaluation Board and Circuit

To be used with Mini-Circuits 50 Ohm 2.92 connectors B20-118-F1+.  
Connectors are sold separately.

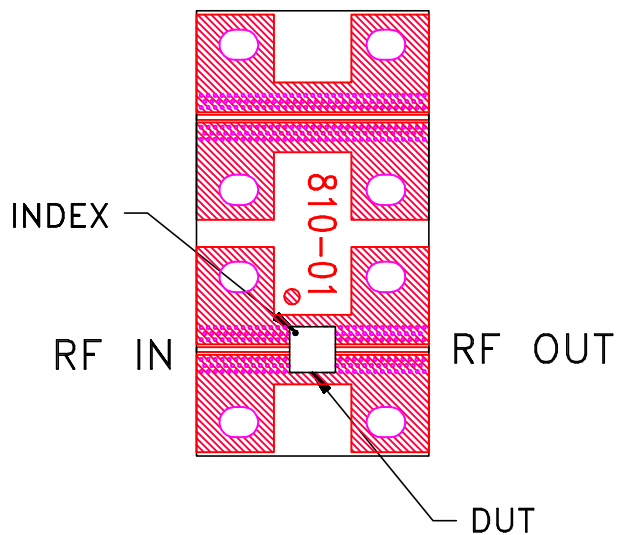

TB-844-551+

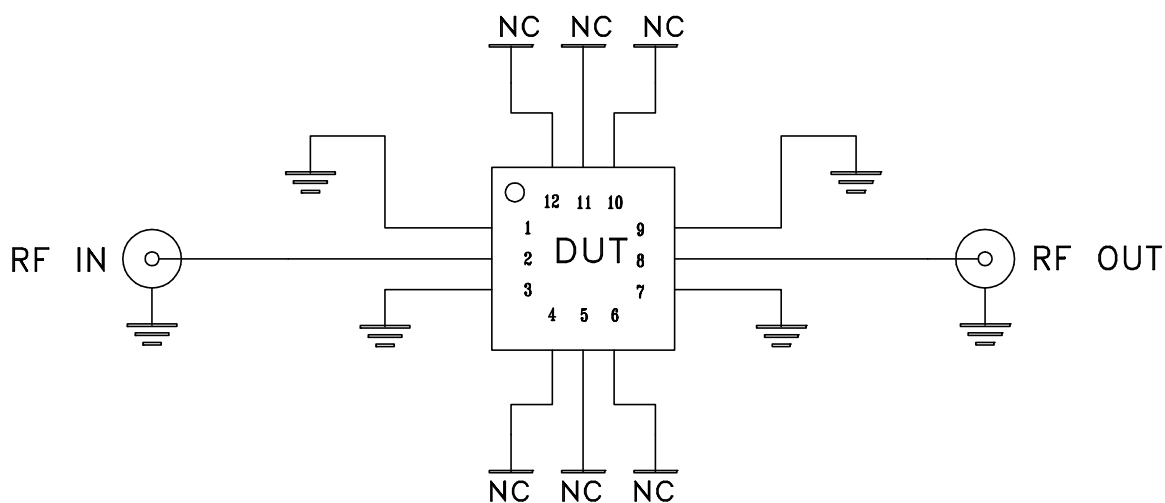

Schematic Diagram

## Note:

PCB Material: R04350 or equivalent,  
Dielectric Constant=3.5, Thickness=.0066 inch.

 **Mini-Circuits®**

# Evaluation Board and Circuit

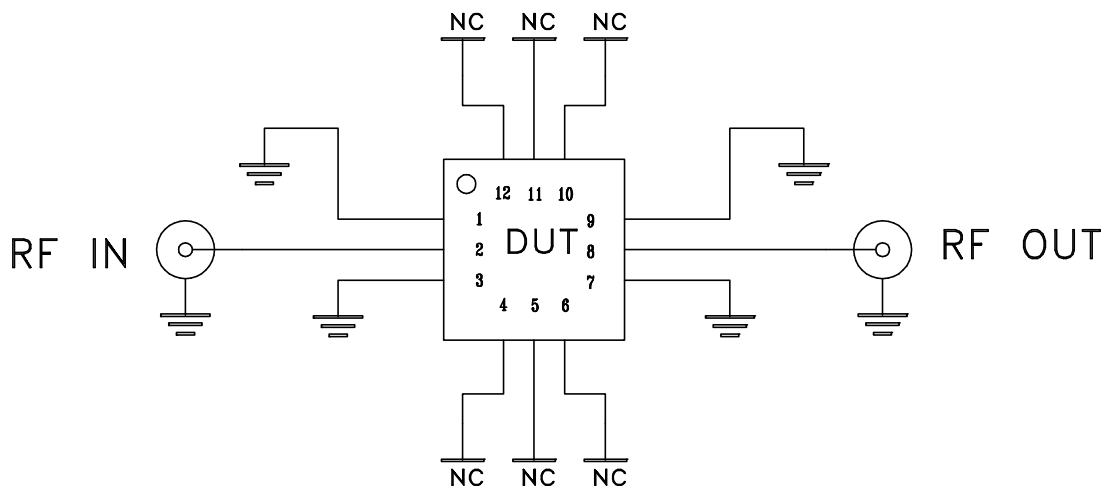
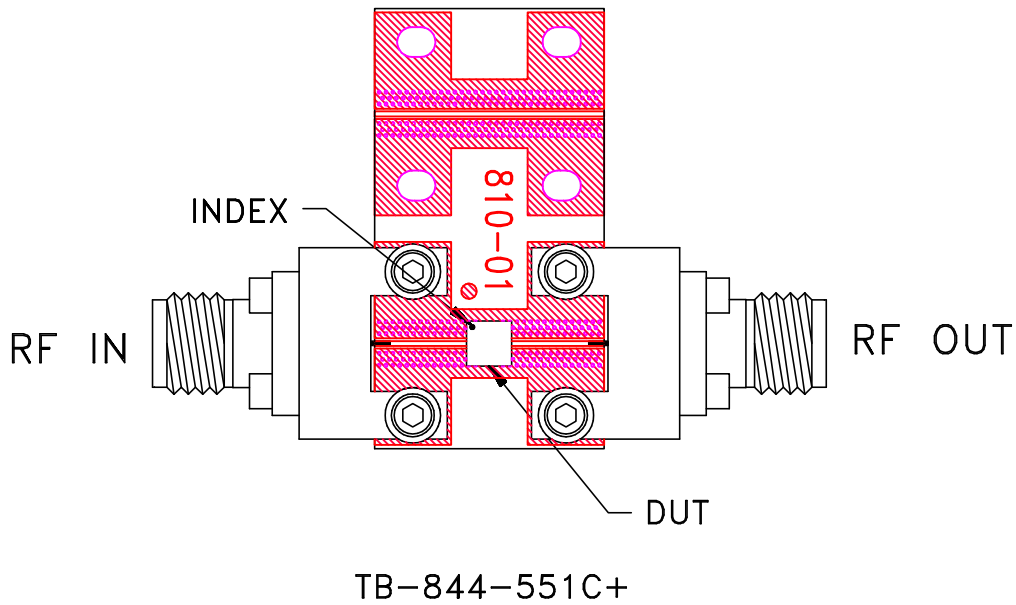

Schematic Diagram

## Notes:

1. 50 Ohm 2.92 mm Female connectors.
2. PCB Material: R04350 or equivalent,  
Dielectric Constant=3.5, Thickness=.0066 inch.

 **Mini-Circuits®**



All Mini-Circuits products are manufactured under exacting quality assurance and control standards, and are capable of meeting published specifications after being subjected to any or all of the following physical and environmental test.

Specification	Test/Inspection Condition	Reference/Spec
Operating Temperature	-55° to 105°C Ambient Environment	Individual Model Data Sheet
Storage Temperature	-65° to 150° C Ambient Environment	Individual Model Data Sheet
Autoclave	15 psig, 100% RH, 121°C, 96 hours	JESD22-A102-C, Condition C
Temperature Cycling	-65° to 150°C, 100 cycles	JESD22-A104
Temperature Humidity	85°C/ 85% RH, 168 hours	JESD22-113
Solder Reflow Heat	Sn-Pb Eutetic Process: 240°C peak Pb-Free Process: 260°C peak	J-STD-020, Table 4-1, 4-2 and 5-2; Figure 5-1
Moisture Sensitivity: Level 1	Bake at 125°C for 24 hours Soak at 85°C/85% RH for 168 hours, Reflow 3 cycles at 240°C peak (Non-RoHS) or 260°C (RoHS)	J-STD-020C
Solderability	10X magnification, 95% coverage	JESD22-B102, Method 1: Dip and Look Test
Marking Resistance to Solvents	Isopropyl alcohol + mineral spirits at 25°C; terpene defluxer at 25°C; distilled water + proylene glycol monomethyl ether + monoethanolamine at 63°C to 70°C	MIL-STD-202, Method 215