



## MMIC REFLECTIONLESS

# Low Pass Filter

## XLF-122H+



50Ω DC to 1200 MHz

### THE BIG DEAL

- Match to 50Ω in the stop band, eliminates undesired reflections
- Cascadable
- Good stopband rejection, 35 dB typ.
- Temperature stable, up to +105°C
- Small size, 4 x 4 mm
- Protected by US Patents 8,392,495; 9,705,467, additional patent pending
- Protected by China Patent 201080014266.1
- Protected by Taiwan Patent I581494

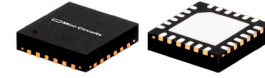

Generic photo used for illustration purposes only

CASE STYLE: DG1847

### +RoHS Compliant

The +Suffix identifies RoHS Compliance. See our website for methodologies and qualifications

### APPLICATIONS

- Mobile
- ISM Applications
- Radio location
- Aeronautical radio navigation

### PRODUCT OVERVIEW

Mini-Circuits' XLF-122H+ three-section reflectionless filter employs a novel filter topology which absorbs and terminates stop band signals internally rather than reflecting them back to the source. This new capability enables unique applications for filter circuits beyond those suited to traditional approaches. Traditional filters are reflective in the stop band, sending signals back to the source at 100% of the power level. These reflections interact with neighboring components and often result in inter-modulation and other interferences. Reflectionless filters eliminate stop band reflections, allowing them to be paired with sensitive devices and used in applications that otherwise require circuits such as isolation amplifiers or attenuators.

### KEY FEATURES

Features	Advantages
Reflectionless Technology	Reflectionless filters absorb unwanted signals, preventing reflections back to the source. This reduces generation of additional unwanted signals without the need for extra components like attenuators, improving system dynamic range and saving board space.
50Ω Match in Stopband	Reflectionless filters maintain good impedance matching in the stopband, allowing for integration with high gain, wideband amplifiers without the risk of creating out-of-band instabilities.
Excellent RF Performance Repeatability	Fabricated on a GaAs process, X-series filters are inherently repeatable for large-volume production.
Excellent Stability over temperature	With ±0.3 dB variation over temperature, is ideal for use in wide temperature range applications without the need for additional temperature compensation.
Excellent Power Handling in a Compact Package	High power handling extends the usability of these filters to the transmit path for inter-stage filtering.

REV. A  
ECO-020598  
XLF-122H+  
MCL NY  
240117





### ELECTRICAL SPECIFICATIONS<sup>1</sup> AT +25°C

Parameter	F#	Frequency (MHz)	Min.	Typ.	Max.	Unit	
Passband	Insertion Loss	DC - F1	DC - 1200	—	1.9	3.0	dB
	Frequency Cut-off	F2	1400	—	3.0	—	
	VSWR	DC - F1	DC - 1200	—	1.3	—	
Stopband	Rejection	F3 - F4	2300 - 2500	14	17	—	dB
		F4 - F5	2500 - 9500	32	35	—	
	VSWR	F3 - F4	2300 - 2500	—	1.3	—	
		F4 - F5	2500 - 9500	—	1.3	—	

1. Measured on Mini-Circuits Characterization Test Board TB-952-122H+

### ABSOLUTE MAXIMUM RATINGS<sup>2</sup>

Parameter	Ratings
Operating Temperature	-55°C to +105°C
Storage Temperature	-65°C to +150°C
RF Power Input, Passband (DC-F1) <sup>3</sup>	7.9 W at +25°C
RF Power Input, Stopband (F2-F5) <sup>4</sup>	1.58 W at +25°C

- 2. Permanent damage may occur if any of these limits are exceeded.
- 3. Passband rating derates linearly to 3.9 W at 105°C ambient
- 4. Stopband rating derates linearly to 0.75 W at 105°C ambient

### SPECIFICATION DEFINITION

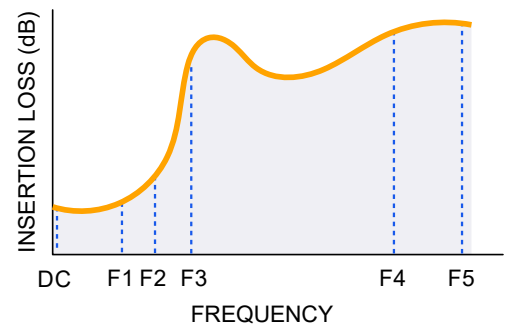



### SIMPLIFIED SCHEMATIC AND PAD DESCRIPTION

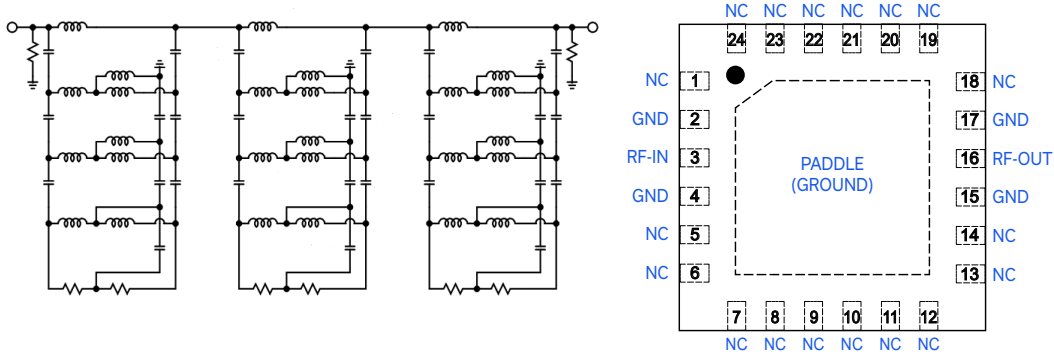

Function	Pad Number	Description
RF-IN	3	RF Input Pad
RF-OUT	16	RF Output Pad
GND	2,4,15,17 & paddle	Connected to ground
NC (GND Externally)	1, 5-14,18-24	No internal connection

### PRODUCT MARKING

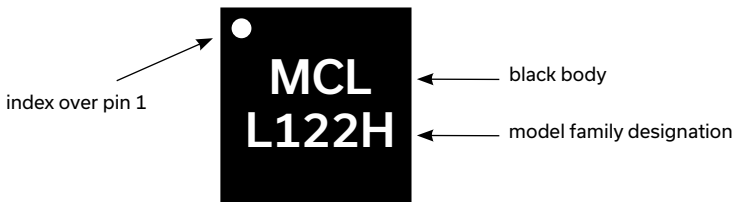

Marking may contain other features or characters for internal lot control



TYPICAL PERFORMANCE DATA AT +25°C

Frequency (MHz)	Insertion Loss (dB)	VSWR (:1)
10	1.38	1.21
100	1.39	1.22
500	1.67	1.35
1000	2.27	1.35
1200	2.56	1.26
1400	2.95	1.15
1500	3.22	1.13
1700	4.04	1.19
2000	6.76	1.25
2300	17.30	1.23
2500	40.85	1.27
3500	48.50	1.49
3500	48.50	1.49
4500	36.76	1.28
5500	66.85	1.10
6500	60.62	1.12
8000	46.80	1.45
9500	41.71	1.78

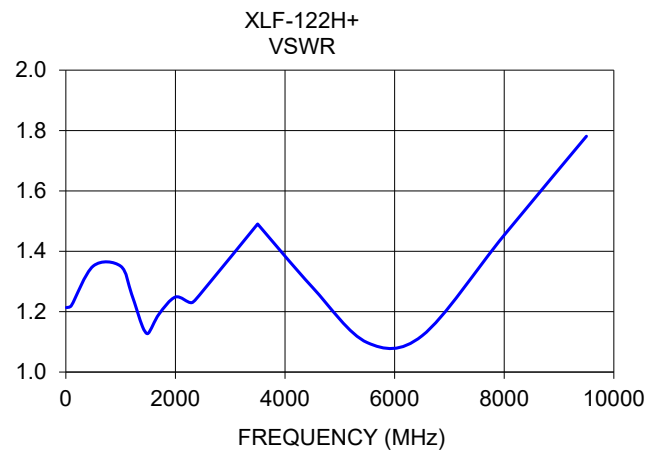



ADDITIONAL DETAILED TECHNICAL INFORMATION IS AVAILABLE ON OUR DASH BOARD. TO ACCESS [CLICK HERE](#)

<b>Performance Data and Graphs</b>	Data Graphs S-Parameter (S2P Files) Data Set (.zip file)
<b>Case Style</b>	DG1847 Plastic package, exposed paddle lead finish: matte-tin
<b>Tape &amp; Reel Standard quantities available on reel</b>	F68 7" reels with 20, 50, 100, 200, 500 ,1000 devices 13" reels with 2000, 3000, 4000 devices
<b>Suggested Layout for PCB Design</b>	PL-519
<b>Evaluation Board</b>	TB-952-122H+
<b>Environmental Ratings</b>	ENV82

### ESD RATING

Human body model (HBM): Class 1A (Pass 250V) in accordance with ANSI/ESD 5.1-2001



### REFLECTIONLESS FILTER APPLICATION NOTE

Application Circuit Example: Pairing mixers with reflectionless filters to improve system dynamic range

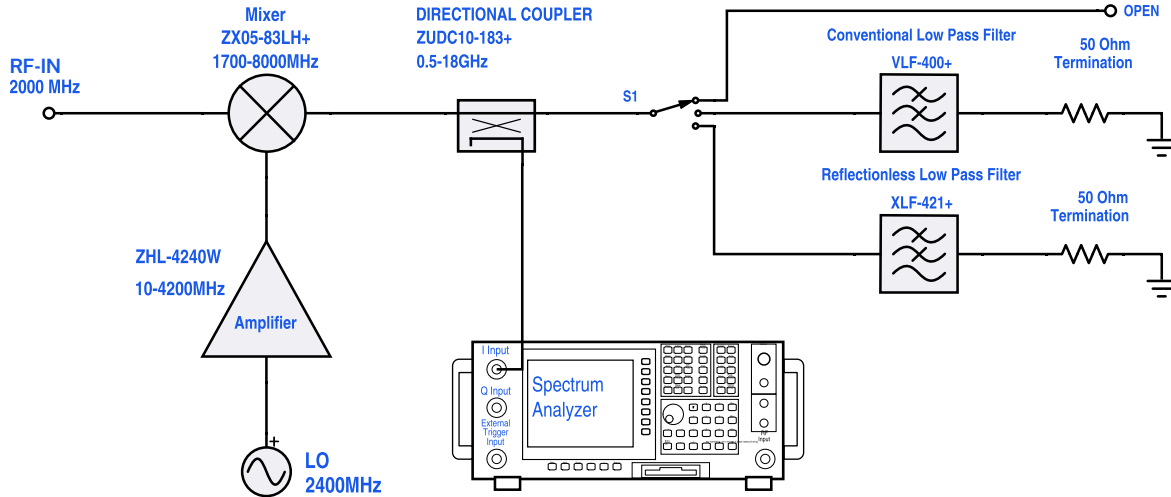

Test block diagram: IF output reflection spectrum with single input frequency

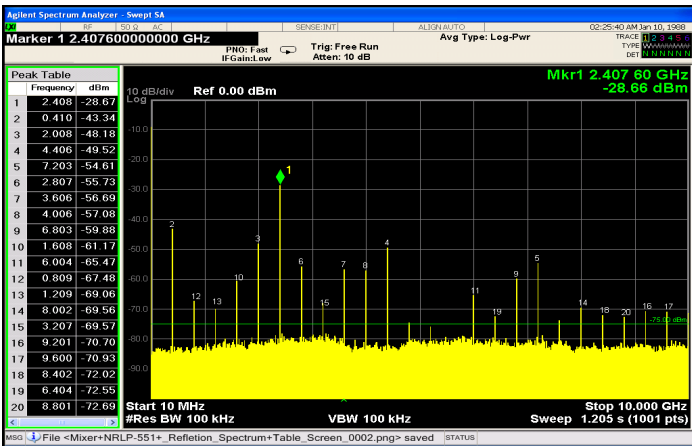

Figure 1. IF output reflection spectrum without filter

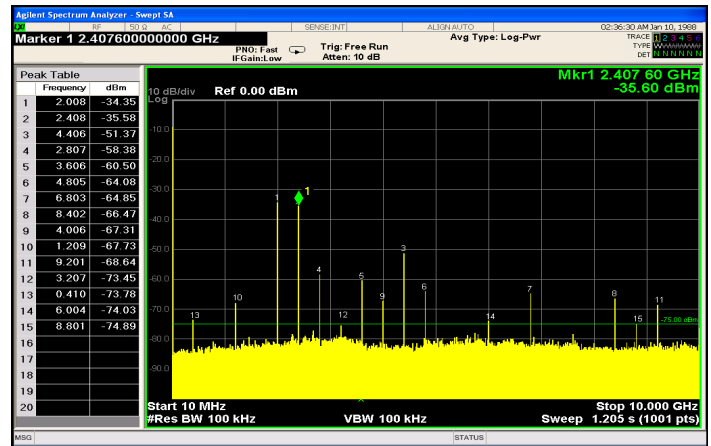
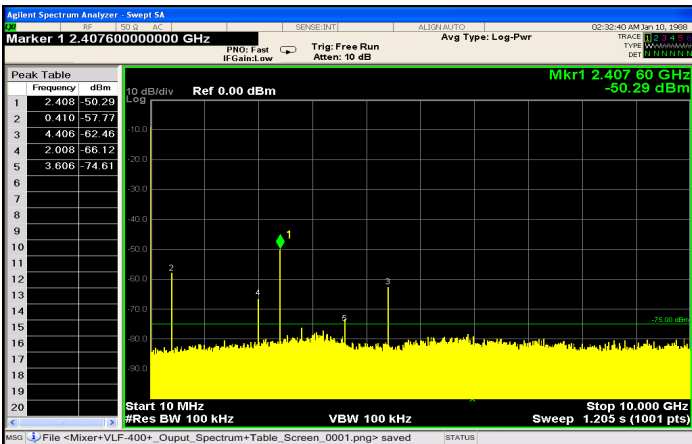

Figure 2. IF output reflection spectrum with conventional filter



An application circuit was assembled to measure the IF reflection spectrum at the output of a mixer when the mixer is paired with a conventional filter versus a reflectionless filter.

While the conventional filter reduces the reflections present when the mixer is used alone (no filter), the reflectionless filter virtually eliminates those reflections altogether.

The reflected signal at marker 1 in the figures above exhibits a reduction of more than 20 dB from -28.7 dBm to -50.3 dBm when the reflectionless filter is used as compared to the conventional filter, thus eliminating unwanted spurious mixing products and improving system dynamic range.

For more information, refer to application note [AN-75-007](#)

- NOTES
- A. Performance and quality attributes and conditions not expressly stated in this specification document are intended to be excluded and do not form a part of this specification document.
  - B. Electrical specifications and performance data contained in this specification document are based on Mini-Circuit's applicable established test performance criteria and measurement instructions.
  - C. The parts covered by this specification document are subject to Mini-Circuits standard limited warranty and terms and conditions (collectively, "Standard Terms"); Purchasers of this part are entitled to the rights and benefits contained therein. For a full statement of the standard terms and the exclusive rights and remedies thereunder, please visit Mini-Circuits' website at [www.minicircuits.com/MCLStore/terms.jsp](http://www.minicircuits.com/MCLStore/terms.jsp)

## Typical Performance Data

FREQ.  (MHz)	INSERTION LOSS			INPUT RETURN LOSS			OUTPUT RETURN LOSS		
	(dB)			(dB)			(dB)		
	@-55°C	@25°C	@+105°C	@-55°C	@+25°C	@+105°C	@-55°C	@+25°C	@+105°C
10	1.05	1.38	1.62	23.95	20.31	18.42	23.79	20.44	18.38
50	1.04	1.39	1.62	23.71	20.44	18.32	23.43	20.31	18.33
100	1.04	1.39	1.63	23.06	20.08	18.08	22.64	20.15	18.29
300	1.11	1.49	1.76	19.62	18.23	16.72	19.65	18.25	16.97
400	1.17	1.57	1.86	18.22	17.27	16.04	18.20	17.28	16.25
500	1.25	1.67	1.98	17.20	16.53	15.51	17.19	16.52	15.66
700	1.44	1.89	2.24	15.69	15.76	15.24	15.98	15.70	15.14
1000	1.76	2.27	2.69	16.36	16.70	16.48	16.32	16.52	16.23
1200	2.01	2.56	3.04	18.33	19.11	19.18	18.33	18.84	18.38
1400	2.33	2.95	3.51	23.28	23.43	22.73	22.48	23.02	22.74
1500	2.55	3.22	3.83	25.29	24.77	23.24	24.79	24.42	23.84
2300	14.30	17.30	19.82	19.68	20.06	20.19	19.03	19.69	20.83
2500	40.32	40.85	40.32	18.70	18.78	18.73	18.09	18.54	19.09
3000	41.73	43.01	44.24	13.32	13.71	14.74	13.09	13.96	15.01
3500	50.60	48.44	46.84	13.49	14.11	15.54	13.53	14.96	15.39
4000	34.99	35.47	35.83	15.98	16.25	16.74	16.68	17.64	17.83
4500	35.57	36.74	37.72	17.74	18.20	17.83	19.16	19.94	20.49
5000	43.30	45.14	46.53	19.79	20.83	19.88	24.40	22.70	24.67
5500	62.73	66.81	67.73	24.61	26.65	24.90	30.55	28.92	29.22
6000	64.22	62.79	62.81	34.42	38.20	31.21	38.50	37.09	30.37
6500	57.82	60.61	59.78	24.40	24.94	23.65	23.89	25.03	26.53
7000	56.18	56.84	57.55	19.27	19.80	17.89	19.33	20.02	21.26
7500	50.71	51.06	51.56	16.18	16.76	14.35	17.69	17.05	16.05
8000	46.64	46.80	46.88	14.50	14.66	12.73	15.95	15.02	13.20
8500	43.93	44.14	44.57	12.98	13.11	12.33	14.27	13.55	12.83
9000	42.09	42.62	42.69	11.48	11.92	12.13	12.89	12.49	13.04
9500	41.38	41.71	42.06	10.92	11.03	11.60	12.34	11.72	12.90
10000	40.89	41.36	41.65	10.93	10.33	11.14	12.56	11.15	13.22
10500	40.46	41.06	41.54	10.28	9.75	11.07	11.59	10.66	13.10
11000	40.73	41.18	41.75	9.32	9.29	10.65	10.43	10.22	12.31
11500	41.09	41.44	42.11	8.94	8.90	9.40	10.71	9.75	9.71
12000	41.39	41.73	42.90	8.69	8.54	8.48	9.23	9.29	8.99
12500	42.08	42.20	42.70	8.08	8.29	8.26	7.57	8.82	9.68
13000	41.78	42.39	42.64	7.31	8.05	8.26	7.35	8.42	8.66
13500	41.90	42.40	41.97	7.00	7.89	8.12	7.41	8.06	8.17
14000	43.11	42.94	44.57	6.97	7.75	7.78	7.18	7.81	8.00
14500	43.38	43.53	45.76	7.16	7.63	7.36	7.24	7.63	7.58
15000	43.36	45.03	45.86	7.69	7.51	6.88	6.68	7.59	7.42
15500	46.40	49.24	51.52	8.07	7.44	6.79	6.27	7.65	6.90
16000	58.46	65.31	55.51	7.96	7.75	8.50	7.18	8.27	7.48
16500	49.66	53.35	54.73	9.12	9.96	12.18	8.66	10.96	10.81
17000	52.93	52.94	53.83	12.31	11.08	11.54	9.53	12.39	11.52
17500	51.74	52.06	52.39	11.29	9.99	9.38	11.58	11.19	8.86
18000	50.80	51.16	51.84	9.89	9.28	8.61	12.50	10.49	8.78
18500	50.36	51.02	50.31	8.32	8.85	9.03	8.95	10.01	10.48
19000	50.53	50.60	51.69	7.20	8.51	9.37	8.64	9.63	8.53
19500	49.21	49.91	49.23	6.71	8.05	8.54	9.86	9.16	9.08
20000	47.86	48.25	49.20	6.65	7.65	7.50	7.45	8.81	12.93
20500	47.53	46.37	46.31	7.03	7.26	7.11	7.47	8.48	12.88
21000	45.16	44.75	46.44	7.04	6.90	7.09	8.80	8.10	10.20
21500	45.30	43.82	44.52	6.39	6.62	7.66	8.92	7.62	9.00
22000	44.99	42.84	43.72	6.24	6.36	8.60	10.31	7.37	7.59
22500	43.11	42.13	43.15	6.54	6.15	8.39	8.79	7.00	6.86
23000	39.96	41.33	42.80	7.01	6.00	6.85	5.76	6.63	7.01
23500	39.45	40.61	41.03	6.81	5.84	5.54	6.47	6.32	6.35
24000	39.13	40.05	41.32	6.39	5.70	5.21	7.11	5.94	7.16
24500	39.53	39.37	40.86	5.70	5.53	5.32	4.50	5.54	8.57
25000	40.61	39.13	40.36	4.67	5.40	5.40	4.25	5.26	7.07
25500	40.05	39.17	40.06	4.58	5.34	5.77	5.43	4.97	5.18
26000	39.93	40.07	41.03	4.62	5.56	5.17	4.87	4.89	5.35



## Typical Performance Curves

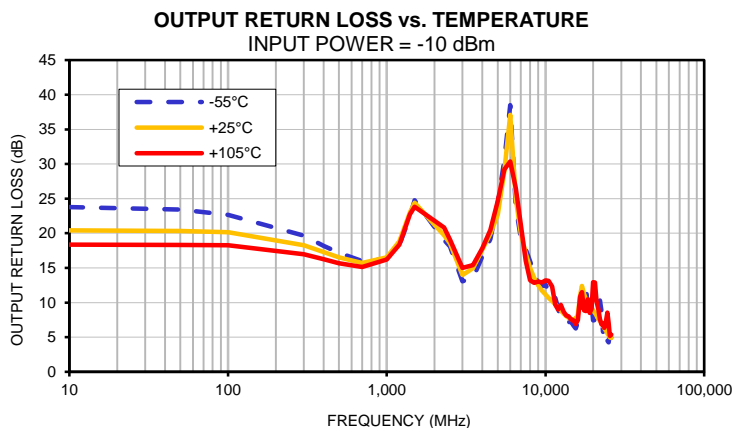
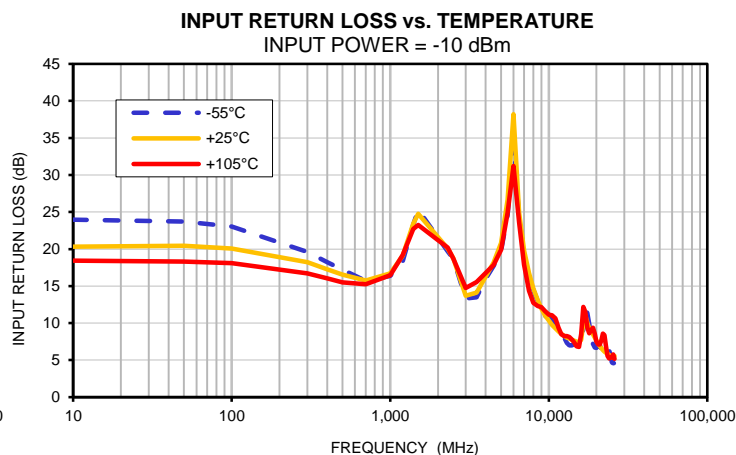
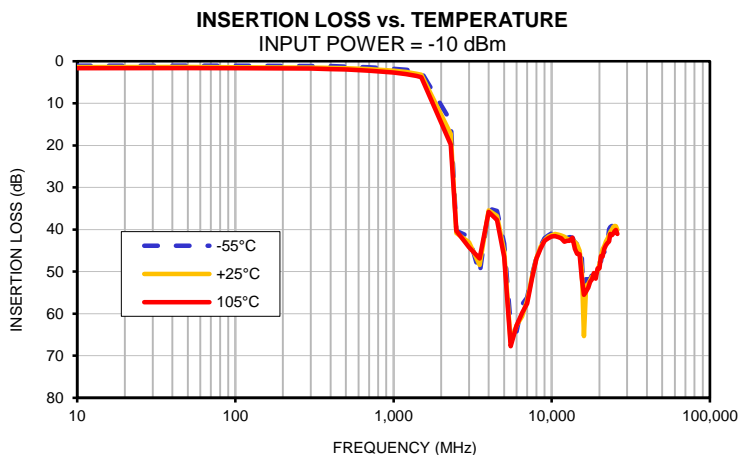



### Outline Dimensions

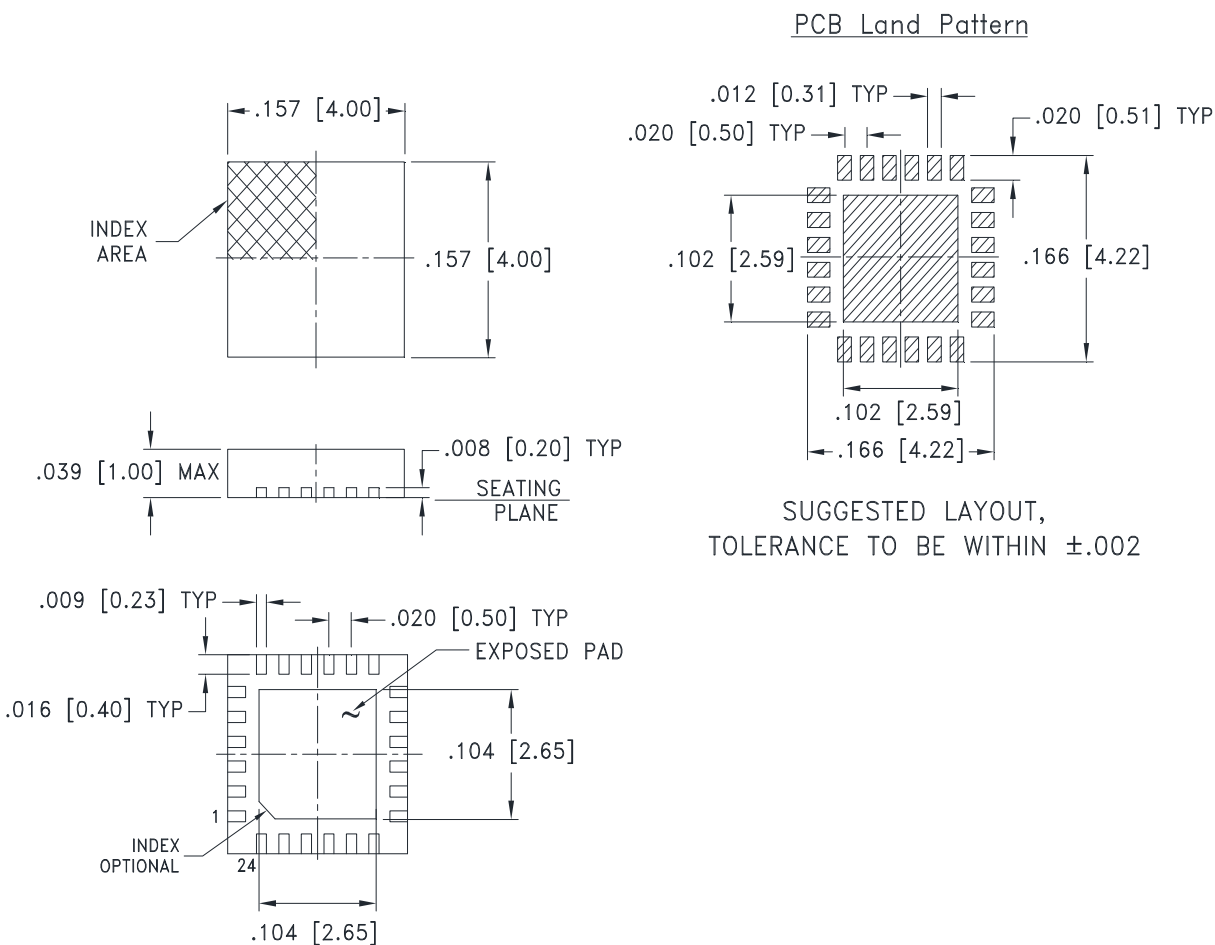

**Weight: .04 Grams**

**Dimensions are in inches (mm). Tolerances: 2 Pl.  $\pm$  .01; 3 Pl.  $\pm$  .005**

#### Notes:

1. Case material: Plastic.
2. Termination finish:
  - For RoHS Case Styles: Tin-Silver alloy plate over Nickel barrier or Matte-Tin. All models, (+) suffix. See model Data sheet.
  - For RoHS-5 Case Styles: Tin-Lead plate. All models, no (+) suffix.

**Mini-Circuits®**  
ISO 9001 ISO 14001 CERTIFIED

ALL NEW  
minicircuits.com

P.O. Box 350166, Brooklyn, New York 11235-0003 (718) 934-4500 Fax (718) 332-4661 For detailed performance specs & shopping online see Mini-Circuits web site



The Design Engineers Search Engine Provides ACTUAL Data Instantly From MINI-CIRCUITS At: [www.minicircuits.com](http://www.minicircuits.com)

RF/IF MICROWAVE COMPONENTS

DG1847 Rev.: AH (16 FEB 23) ECO-016811 File: DG1847

This document and its contents are the property of Mini-Circuits.

# Tape & Reel Packaging TR-F68

## DEVICE ORIENTATION IN T&R



Tape Width, mm	Device Cavity Pitch, mm	Reel Size, inches	Devices per Reel see note	
12	8	7	Small quantity standard	20
				50
				100
				200
				500
		7	Standard	1000
		13	Standard	2000
				3000
4000				

Mini-Circuits carrier tape materials provide protection from ESD (Electro-Static Discharge) during handling and transportation. Tapes are static dissipative and comply with industry standards EIA-481/EIA-541.

Go to: [www.minicircuits.com/pages/pdfs/tape.pdf](http://www.minicircuits.com/pages/pdfs/tape.pdf)



INTERNET <http://www.minicircuits.com>

P.O. Box 350166, Brooklyn, New York 11235-0003 (718) 934-4500 Fax (718) 332-4661

Distribution Centers NORTH AMERICA 800-654-7949 • 417-335-5935 • Fax 417-335-5945 • EUROPE 44-1252-832600 • Fax 44-1252-837010

Mini-Circuits ISO 9001 & ISO 14001 Certified

THIRD ANGLE PROJECTION

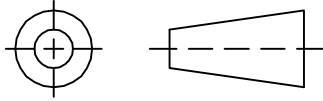

REVISIONS

REV	ECN No.	DESCRIPTION	DATE	DR	AUTH
OR	M162496	NEW RELEASE	06/15/17	GF	RS

SUGGESTED MOUNTING CONFIGURATION FOR DG1847 CASE STYLE, "24FL01" PIN CONNECTION

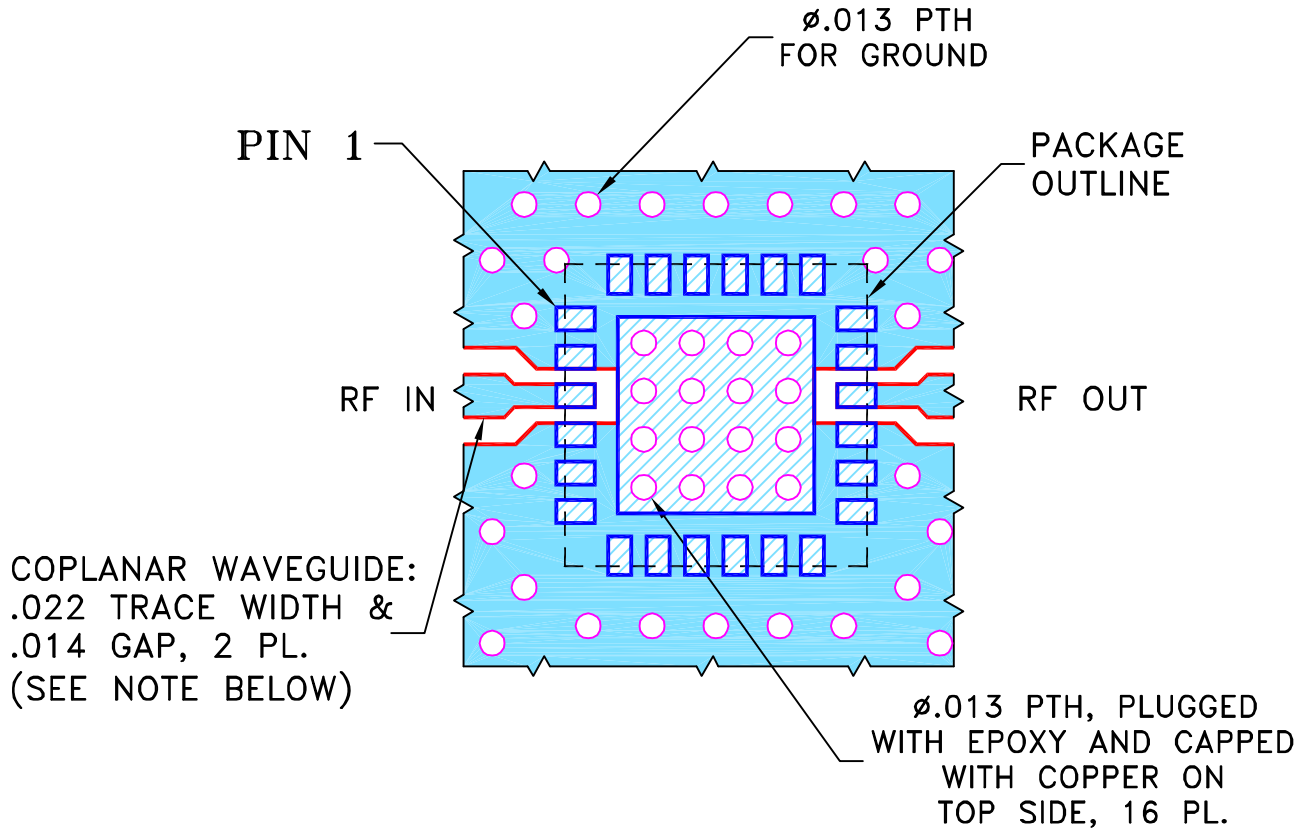

**NOTES:**

- TRACE WIDTH & GAP ARE SHOWN FOR ROGERS RO4350B WITH DIELECTRIC THICKNESS .010" ± .001"; COPPER: 1/2 OZ. EACH SIDE. FOR OTHER MATERIALS TRACE WIDTH MAY NEED TO BE MODIFIED.
- BOTTOM SIDE OF THE PCB IS CONTINUOUS GROUND PLANE.



DENOTES PCB COPPER LAYOUT WITH SMOBC (SOLDER MASK OVER BARE COPPER)



DENOTES COPPER LAND PATTERN FREE OF SOLDER MASK

UNLESS OTHERWISE SPECIFIED	INITIALS	DATE
DRAWN	GF	06/14/17
CHECKED	IL	06/15/17
APPROVED	RS	06/15/17



**Mini-Circuits®**

13 Neptune Avenue  
Brooklyn NY 11235

PL, 24FL01, DG1847, TB-952+

Mini-Circuits®  
 THIS DOCUMENT AND ITS CONTENTS ARE THE PROPERTY OF MINI-CIRCUITS. EXCEPT FOR USE EXPRESSLY GRANTED, IN WRITING, TO ITS VENDORS, VENDEE AND THE UNITED STATES GOVERNMENT, MINI-CIRCUITS RESERVES ALL PROPRIETARY DESIGN, USE, MANUFACTURING AND REPRODUCTION RIGHTS THERETO. THESE CONTENTS SHALL NOT BE USED, DUPLICATED OR DISCLOSED TO ANY OUTSIDE PARTY, IN WHOLE OR IN PART, WITHOUT WRITTEN PERMISSION OF MINI-CIRCUITS.

SIZE	CODE IDENT	DRAWING NO:	REV:
A	15542	98-PL-519	OR
FILE:	98PL519	SCALE:	10:1
SHEET:	1	OF	1

# Evaluation Board and Circuit

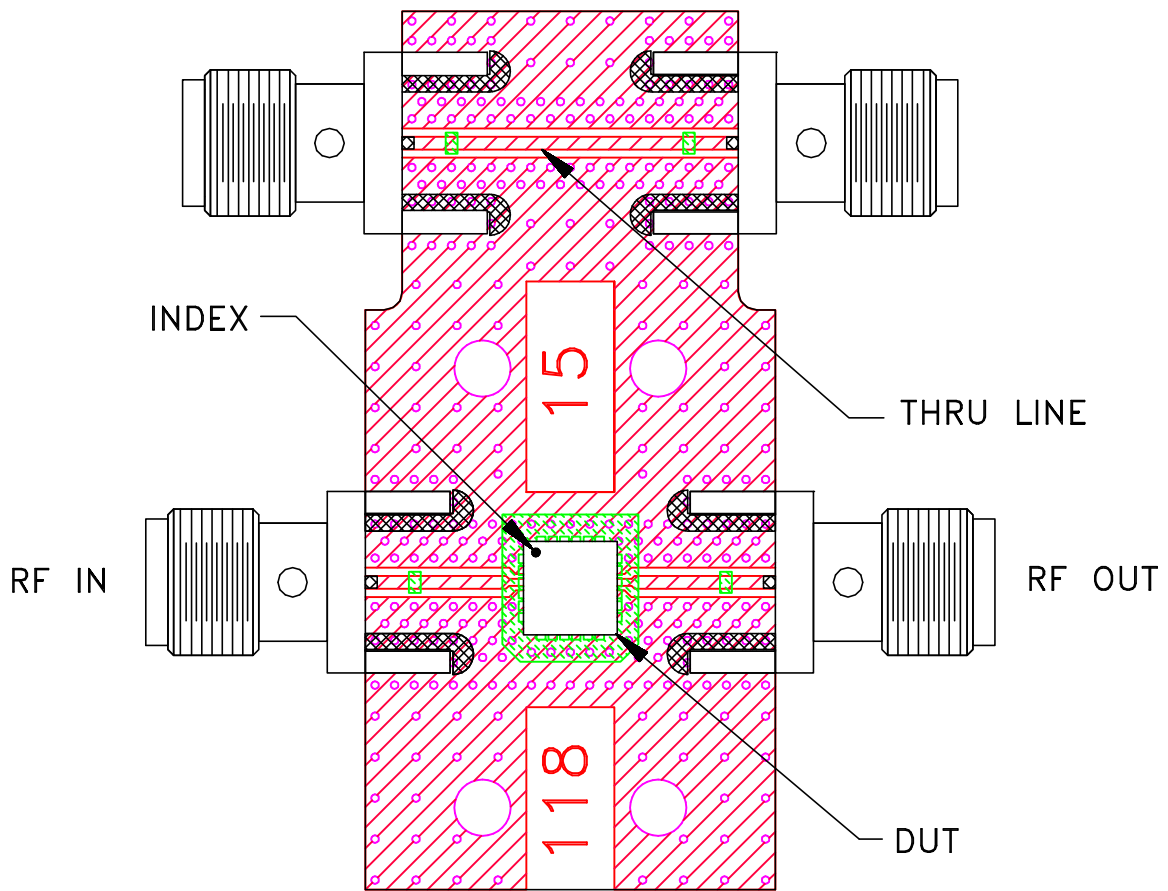

TB-952-122H+

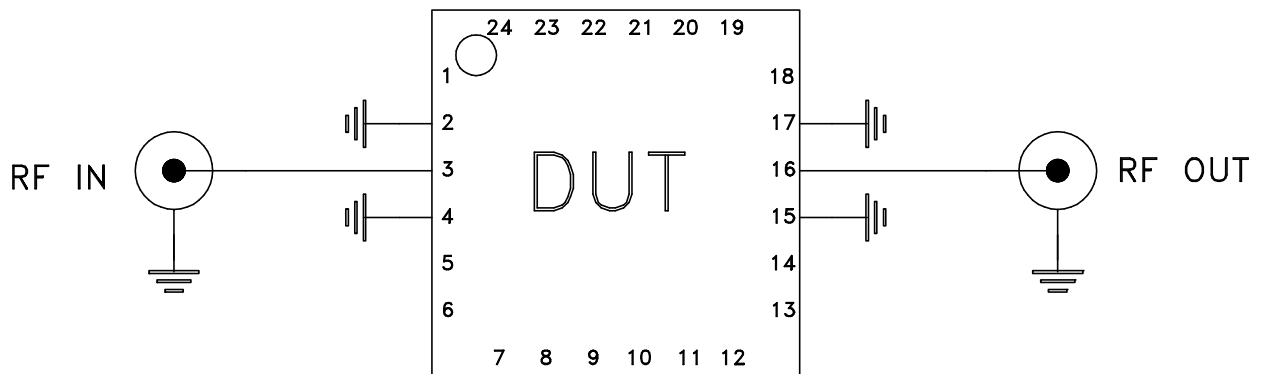

PINS 1,5-14,18-24 - NOT CONNECTED.

Schematic Diagram

## Notes:

1. 50 Ohm SMA Female connectors.
2. PCB Material: R04350 or equivalent,  
Dielectric Constant=3.5, Thickness=.010 inch.

 **Mini-Circuits®**



All Mini-Circuits products are manufactured under exacting quality assurance and control standards, and are capable of meeting published specifications after being subjected to any or all of the following physical and environmental test.

Specification	Test/Inspection Condition	Reference/Spec
Operating Temperature	-55° to 105°C Ambient Environment	Individual Model Data Sheet
Storage Temperature	-65° to 150° C Ambient Environment	Individual Model Data Sheet
Autoclave	15 psig, 100% RH, 121°C, 96 hours	JESD22-A102-C, Condition C
Temperature Cycling	-65° to 150°C, 100 cycles	JESD22-A104
Temperature Humidity	85°C/ 85% RH, 168 hours	JESD22-113
Solder Reflow Heat	Sn-Pb Eutetic Process: 240°C peak Pb-Free Process: 260°C peak	J-STD-020, Table 4-1, 4-2 and 5-2; Figure 5-1
Moisture Sensitivity: Level 1	Bake at 125°C for 24 hours Soak at 85°C/85% RH for 168 hours, Reflow 3 cycles at 240°C peak (Non-RoHS) or 260°C (RoHS)	J-STD-020C
Solderability	10X magnification, 95% coverage	JESD22-B102, Method 1: Dip and Look Test
Marking Resistance to Solvents	Isopropyl alcohol + mineral spirits at 25°C; terpene defluxer at 25°C; distilled water + proylene glycol monomethyl ether + monoethanolamine at 63°C to 70°C	MIL-STD-202, Method 215