

# Coaxial Bandpass Filter

50Ω 4900 to 6200 MHz

## VBFZ-5500-S+



Generic photo used for illustration purposes only

CASE STYLE: FF1145

Connectors	Model
SMA	VBFZ-5500-S+

**+RoHS Compliant**

The +Suffix identifies RoHS Compliance. See our web site for RoHS Compliance methodologies and qualifications

### Maximum Ratings

Operating Temperature	-55°C to 100°C
Storage Temperature	-55°C to 100°C
RF Power Input*	7W at 25°C

\*Passband rating, derate linearly to 3W at 100°C ambient. Permanent damage may occur if any of these limits are exceeded.

### Features

- Good Rejection, 30dB up to 17GHz
- Low insertion loss
- Excellent power handling, 7W
- Temperature stable LTCC internal structure
- Rugged stainless steel unibody
- Protected by US Patent 6,943,646

### Applications

- Harmonic rejection
- Transmitters/receivers
- Lab use
- Test instrumentation

### Outline Drawing

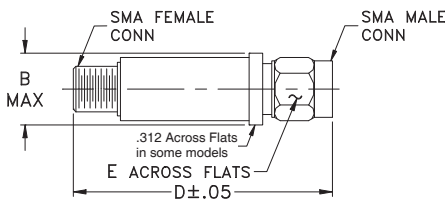

### Outline Dimensions (inch mm)

B	D	E	wt.
.410	1.91	.312	grams
10.41	48.51	7.92	11.8

Note: Please refer to case style drawing for details

### Bandpass Filter Electrical Specifications (T<sub>AMB</sub> = 25°C)

CENTER FREQ. (MHz) Fc	PASSBAND (MHz) (Loss < 2dB) F1 - F2	STOPBANDS (MHz)				VSWR (:1)		
		(Loss > 20dB)		(Loss 30dB Typ)		Passband		Stopband
		F3	F4	F5	F6	Typ.	Max.	Typ.
5500	4900 - 6200	3600	8600	3500	8600 - 17000	1.3	2.1	20

### Typical Frequency Response

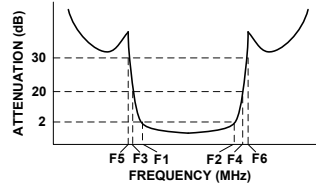

### Functional Schematic

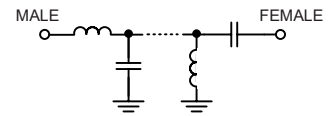

### Typical Performance Data at 25°C

Frequency (MHz)	Insertion Loss (dB)	VSWR (:1)
50	60.32	868.59
1500	37.93	157.93
3500	35.51	49.64
3600	41.94	39.49
3750	30.57	30.49
4000	15.08	17.05
4150	8.84	8.31
4300	4.47	3.66
4450	2.28	1.91
4900	1.14	1.07
5500	1.26	1.43
6200	1.27	1.32
6800	2.83	2.39
7000	4.82	4.03
7300	8.94	7.05
7700	15.82	8.81
8200	28.73	11.77
8600	48.53	15.00
10000	39.46	10.50
17000	34.71	1.53

VBFZ-5500-S+  
INSERTION LOSS

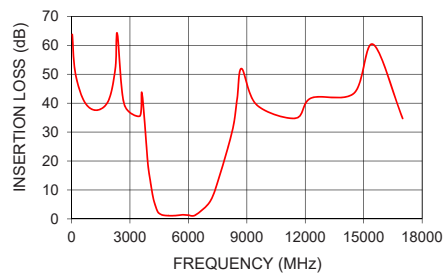

VBFZ-5500-S+  
VSWR

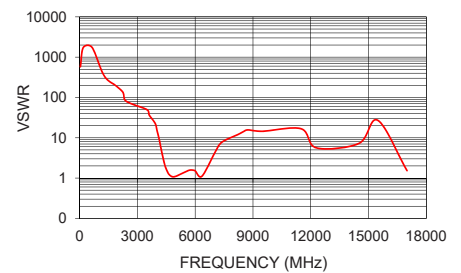

### Notes

- Performance and quality attributes and conditions not expressly stated in this specification document are intended to be excluded and do not form a part of this specification document.
- Electrical specifications and performance data contained in this specification document are based on Mini-Circuit's applicable established test performance criteria and measurement instructions.
- The parts covered by this specification document are subject to Mini-Circuits standard limited warranty and terms and conditions (collectively, "Standard Terms"); Purchasers of this part are entitled to the rights and benefits contained therein. For a full statement of the Standard Terms and the exclusive rights and remedies thereunder, please visit Mini-Circuits' website at [www.minicircuits.com/MCLStore/terms.jsp](http://www.minicircuits.com/MCLStore/terms.jsp)



# Coaxial SMA Band Pass Filter

# VBFZ-5500-S+

## Typical Performance Data

FREQUENCY (MHz)	INSERTION LOSS (dB)	RETURN LOSS (dB)
50	60.32	0.02
1500	37.93	0.11
3500	35.51	0.35
3600	41.94	0.44
3750	30.57	0.57
4000	15.08	1.02
4150	8.84	2.10
4300	4.47	4.87
4450	2.28	10.11
4900	1.14	29.18
5500	1.26	15.06
6200	1.27	17.11
6800	2.83	7.73
7000	4.82	4.40
7300	8.94	2.48
7700	15.82	1.98
8200	28.73	1.48
8600	48.53	1.16
10000	39.46	1.66
17000	34.71	13.61

REV. OR  
VBFZ-5500-S+  
200811  
Page 1 of 1



IF/RF MICROWAVE COMPONENTS • ISO 9001 ISO 14001 AS 9100 CERTIFIED RoHS compliant  
P.O. Box 350166, Brooklyn, New York 11235-0003 (718) 934-4500 Fax (718) 332-4661



The Design Engineers Search Engine finds the model you need, Instantly • For detailed performance specs & shopping online see



# Coaxial SMA Band Pass Filter

# VBFZ-5500-S+

## Typical Performance Curves

### Insertion Loss

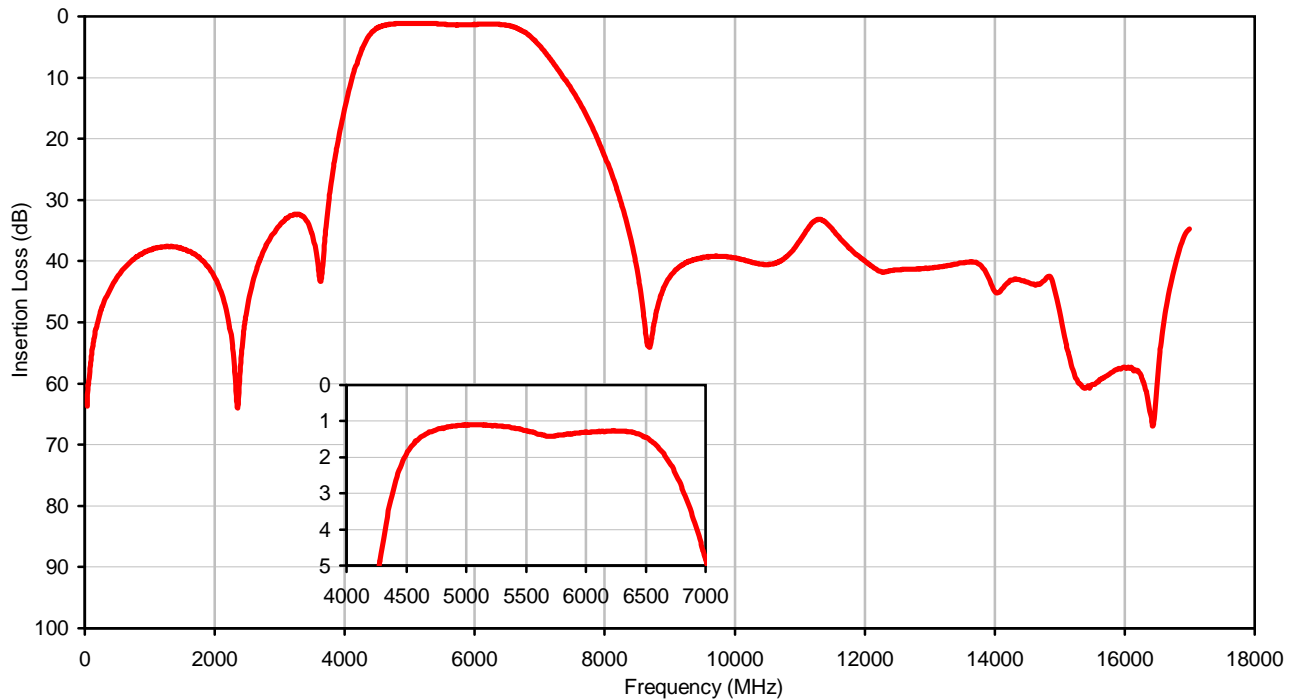

### Return Loss

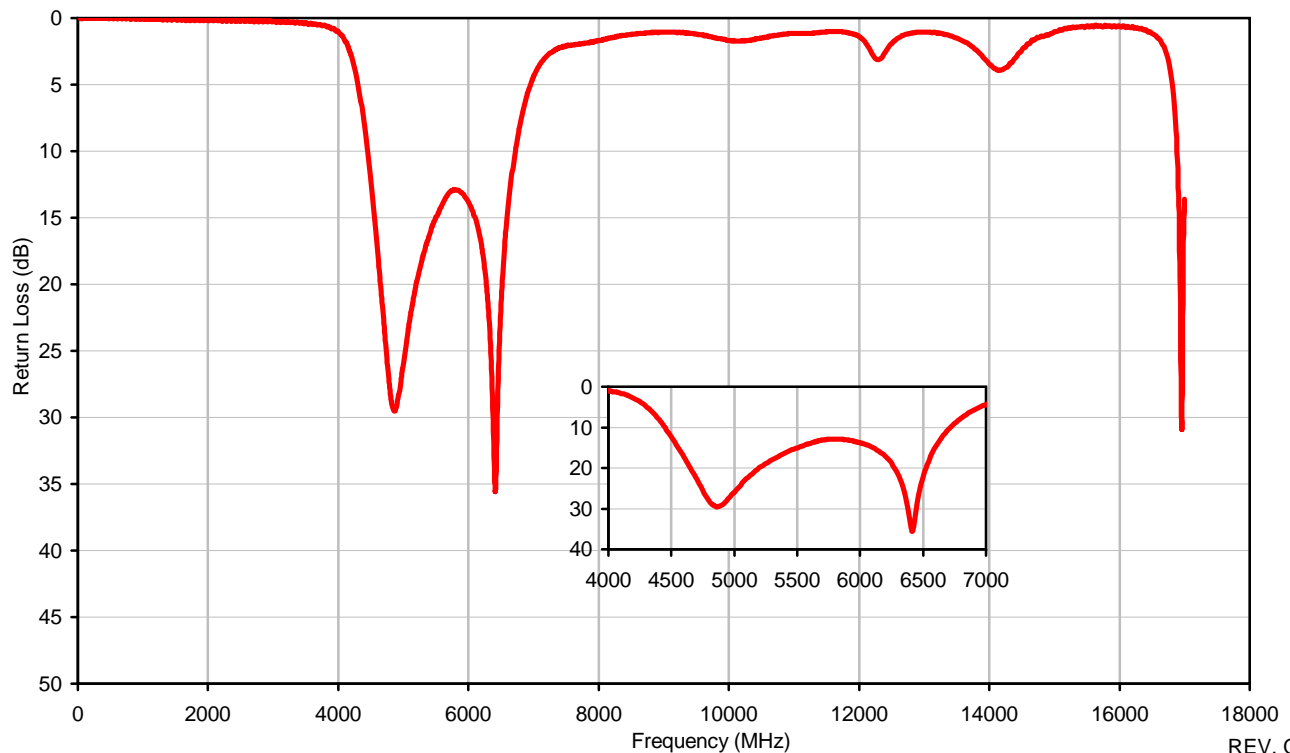

REV. OR  
VBFZ-5500-S+  
200811  
Page 1 of 1



IF/RF MICROWAVE COMPONENTS • ISO 9001 ISO 14001 AS 9100 CERTIFIED RoHS compliant  
P.O. Box 350166, Brooklyn, New York 11235-0003 (718) 934-4500 Fax (718) 332-4661



The Design Engineers Search Engine finds the model you need, Instantly • For detailed performance specs & shopping online see



# Case Style

# FF

## FF1145

### Outline Dimensions

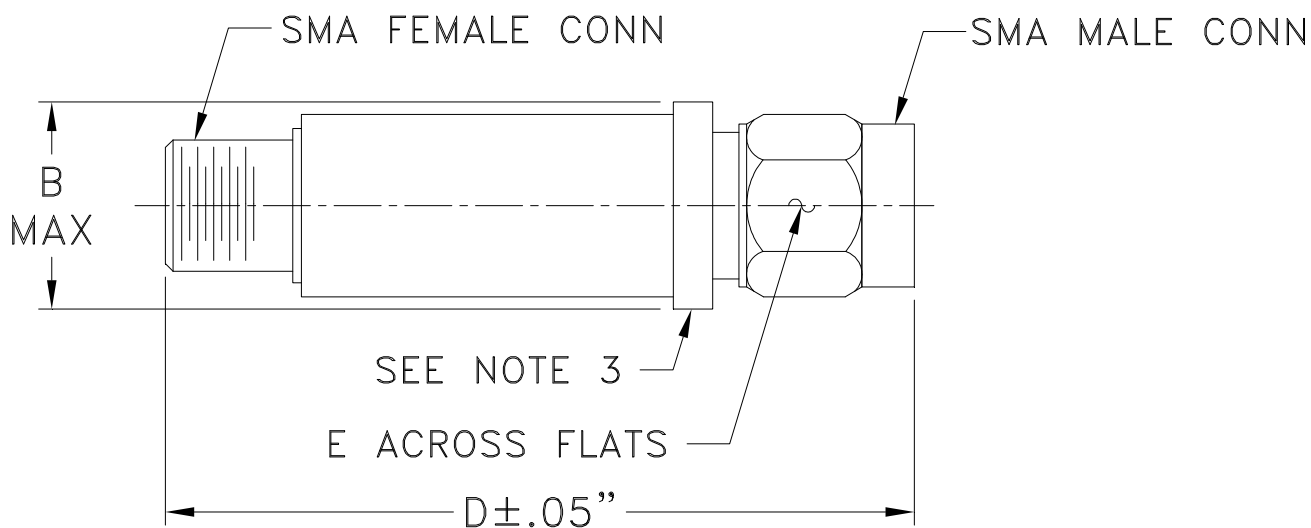

CASE #.	A	B	C	D	E	WT GRAMS
FF1145	--	.410 (10.41)	--	1.91 (48.51)	.312 (7.92)	11.8

Dimensions are in inches (mm). Tolerances: 2Pl. ± .04; 3Pl. ± .030

#### Notes:

1. Case material: Stainless steel.
2. Case finish: Gold plated.
3. Round Flange may have .312 Across Flats in some models.

 **Mini-Circuits**<sup>®</sup>  
ISO 9001 ISO 14001 CERTIFIED

ALL NEW  
  
minicircuits.com

P.O. Box 350166, Brooklyn, New York 11235-0003 (718) 934-4500 Fax (718) 332-4661 For detailed performance specs & shopping online see Mini-Circuits web site



The Design Engineers Search Engine Provides ACTUAL Data Instantly From MINI-CIRCUITS At: [www.minicircuits.com](http://www.minicircuits.com)

RF/IF MICROWAVE COMPONENTS



All Mini-Circuits products are manufactured under exacting quality assurance and control standards, and are capable of meeting published specifications after being subjected to any or all of the following physical and environmental test.

<b>Specification</b>	<b>Test/Inspection Condition</b>	<b>Reference/Spec</b>
Operating Temperature	-55° to 100°C Ambient Environment	Individual Model Data Sheet
Storage Temperature	-55° to 100° C Ambient Environment	Individual Model Data Sheet
Barometric Pressure	100,000 Feet	MIL-STD-202, Method 105, Condition D
Humidity	90% RH, 65°C Units may require bake-out after humidity to restore full performance.	MIL-STD-202, Method 103
Thermal Shock	-65° to 125°C, 5 cycles	MIL-STD-202, Method 107, Condition B
Vibration (High Frequency)	20g peak, 10-2000 Hz, 12 times in each of three perpendicular directions (total 36)	MIL-STD-202, Method 204, Condition D
Mechanical Shock	100g, 6ms sawtooth, 3 shocks each direction 3 axes (total 18)	MIL-STD-202, Method 213, Condition I