

Coaxial Bandpass Filter

VBFZ-2340-S+

50Ω 2020 to 2660 MHz

Maximum Ratings

Operating Temperature	-55°C to 100°C
Storage Temperature	-55°C to 100°C
RF Power Input*	7W at 25°C

*Passband rating, derate linearly to 3W at 100°C ambient. Permanent damage may occur if any of these limits are exceeded.

Features

- Good Rejection, 30dB up to 8.5GHz
- Low insertion loss
- Excellent power handling, 7W
- Temperature stable LTCC internal structure
- Rugged stainless steel unibody
- Protected by US Patent 6,943,646

Application

- Harmonic rejection
- Transmitters/receivers
- Lab use
- Test instrumentation



Generic photo used for illustration purposes only

CASE STYLE: FF1145

Connectors	Model
SMA	VBFZ-2340-S+

+RoHS Compliant

The +Suffix identifies RoHS Compliance. See our web site for RoHS Compliance methodologies and qualifications

Outline Drawing

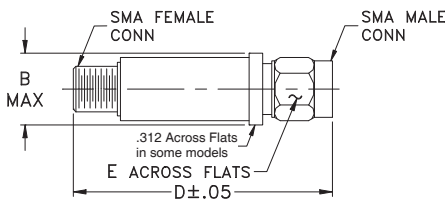

Outline Dimensions (inch mm)

B	D	E	wt.
.410	1.91	.312	grams
10.41	48.51	7.92	11.8

Note: Please refer to case style drawing for details

Bandpass Filter Electrical Specifications (T_{AMB} = 25°C)

CENTER FREQ. (MHz)	PASSBAND (MHz) (Loss < 2.2dB)	STOPBANDS (MHz)				VSWR (:1)		
		(Loss > 20dB)		(Loss 30dB Typ)		Passband		Stopband
Fc	F1 - F2	F3	F4	F5	F6	Typ.	Max.	Typ.
2340	2020 - 2660	1450	3750	1400	3800 - 8500	1.5	2.4	20

Typical Frequency Response

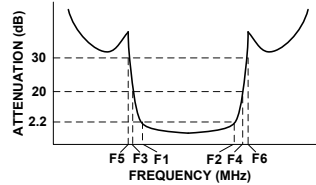

Functional Schematic

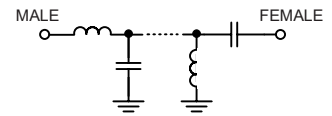

Typical Performance Data at 25°C

Frequency (MHz)	Insertion Loss (dB)	VSWR (:1)
50	79.11	99.13
500	75.05	492.28
1000	55.64	162.13
1400	35.23	33.55
1450	29.70	30.82
1514	23.17	21.16
1630	12.16	9.28
1700	6.35	3.91
1785	2.64	1.47
2020	1.39	1.25
2340	1.51	1.74
2660	1.79	1.89
3145	3.94	2.37
3315	8.89	4.64
3480	16.47	9.08
3750	30.45	17.37
3800	32.80	21.11
3815	33.59	20.28
6000	35.17	30.31
8500	29.30	44.23

VBFZ-2340-S+
INSERTION LOSS

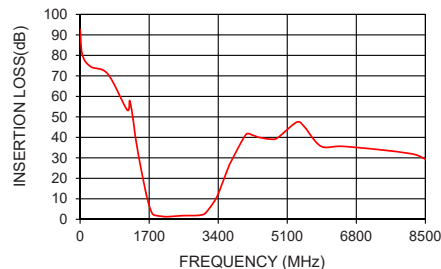

VBFZ-2340-S+
VSWR

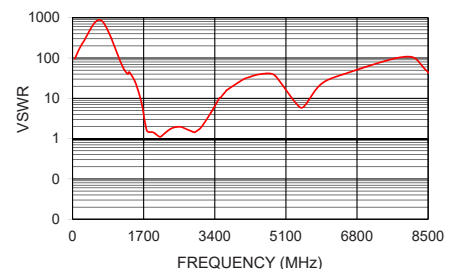

Notes

- Performance and quality attributes and conditions not expressly stated in this specification document are intended to be excluded and do not form a part of this specification document.
- Electrical specifications and performance data contained in this specification document are based on Mini-Circuit's applicable established test performance criteria and measurement instructions.
- The parts covered by this specification document are subject to Mini-Circuits standard limited warranty and terms and conditions (collectively, "Standard Terms"); Purchasers of this part are entitled to the rights and benefits contained therein. For a full statement of the Standard Terms and the exclusive rights and remedies thereunder, please visit Mini-Circuits' website at www.minicircuits.com/MCLStore/terms.jsp



Coaxial SMA Band Pass Filter

VBFZ-2340-S+

Typical Performance Data

FREQUENCY (MHz)	INSERTION LOSS (dB)	RETURN LOSS (dB)
50	79.11	0.18
500	75.05	0.04
1000	55.64	0.11
1400	35.23	0.52
1450	29.70	0.56
1514	23.17	0.82
1630	12.16	1.88
1700	6.35	4.55
1785	2.64	14.43
2020	1.39	19.10
2340	1.51	11.40
2660	1.79	10.26
3145	3.94	7.83
3315	8.89	3.81
3480	16.47	1.92
3800	32.80	0.82
3815	33.59	0.86
6000	35.17	0.57
8500	29.30	0.39
9000	24.43	0.62

REV. OR
VBFZ-2340-S+
200810
Page 1 of 1



IF/RF MICROWAVE COMPONENTS • ISO 9001 ISO 14001 AS 9100 CERTIFIED RoHS compliant
P.O. Box 350166, Brooklyn, New York 11235-0003 (718) 934-4500 Fax (718) 332-4661



The Design Engineers Search Engine finds the model you need, Instantly • For detailed performance specs & shopping online see



Coaxial SMA Band Pass Filter

VBFZ-2340-S+

Typical Performance Curves

Insertion Loss

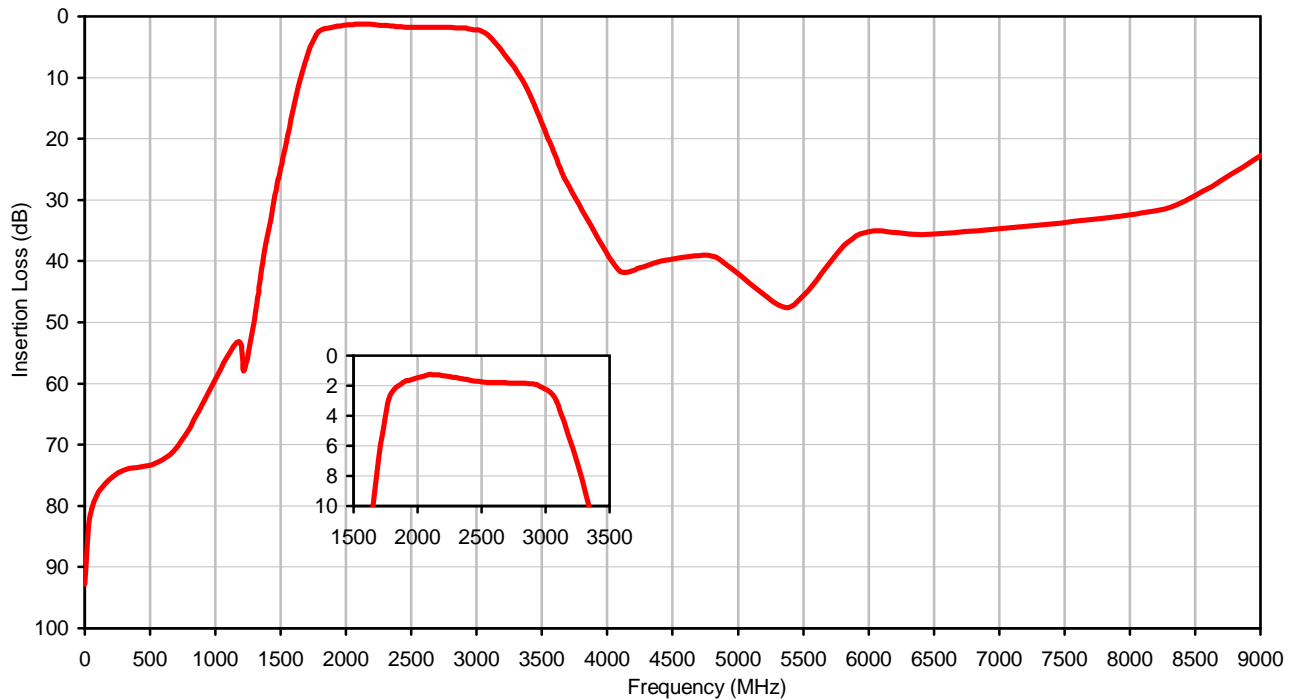

Return Loss

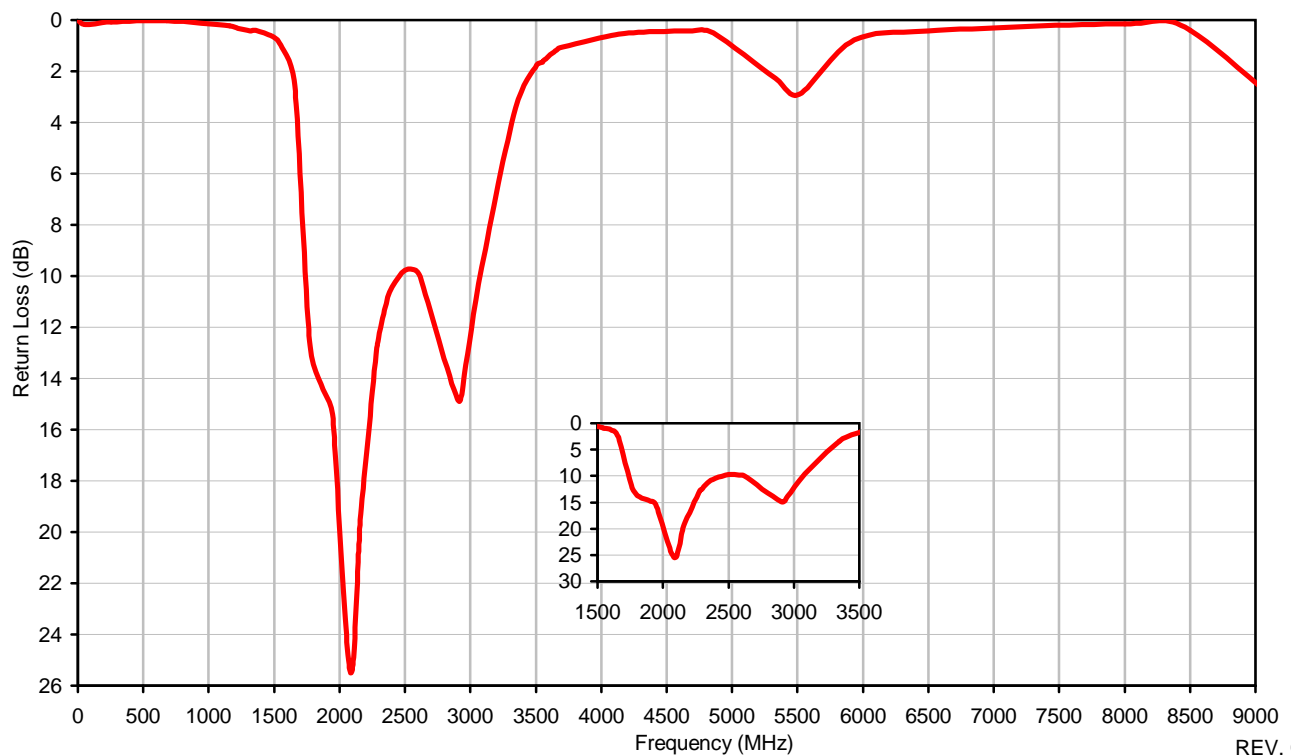

REV. OR

VBFZ-2340-S+

200810

Page 1 of 1



IF/RF MICROWAVE COMPONENTS • ISO 9001 ISO 14001 AS 9100 CERTIFIED RoHS compliant

P.O. Box 350166, Brooklyn, New York 11235-0003 (718) 934-4500 Fax (718) 332-4661



The Design Engineers Search Engine finds the model you need, Instantly • For detailed performance specs & shopping online see



Case Style

FF

FF1145

Outline Dimensions

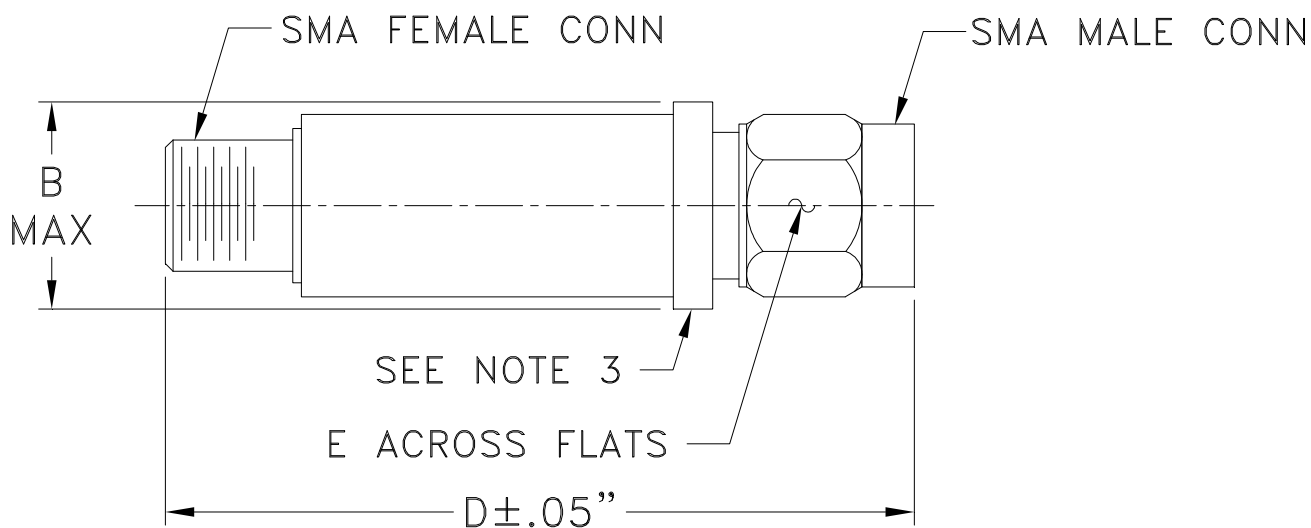

CASE #.	A	B	C	D	E	WT GRAMS
FF1145	--	.410 (10.41)	--	1.91 (48.51)	.312 (7.92)	11.8

Dimensions are in inches (mm). Tolerances: 2Pl. ± .04; 3Pl. ± .030

Notes:

1. Case material: Stainless steel.
2. Case finish: Gold plated.
3. Round Flange may have .312 Across Flats in some models.

Mini-Circuits[®]
ISO 9001 ISO 14001 CERTIFIED

ALL NEW
minicircuits.com

P.O. Box 350166, Brooklyn, New York 11235-0003 (718) 934-4500 Fax (718) 332-4661 For detailed performance specs & shopping online see Mini-Circuits web site



The Design Engineers Search Engine Provides ACTUAL Data Instantly From MINI-CIRCUITS At: www.minicircuits.com

RF/IF MICROWAVE COMPONENTS

FF1145 Rev.: AR (13/AUG/21) ECO-009237 File: FF1145

This document and its contents are the property of Mini-Circuits.

Sheet 1 of 1

All Mini-Circuits products are manufactured under exacting quality assurance and control standards, and are capable of meeting published specifications after being subjected to any or all of the following physical and environmental test.

Specification	Test/Inspection Condition	Reference/Spec
Operating Temperature	-55° to 100°C Ambient Environment	Individual Model Data Sheet
Storage Temperature	-55° to 100° C Ambient Environment	Individual Model Data Sheet
Barometric Pressure	100,000 Feet	MIL-STD-202, Method 105, Condition D
Humidity	90% RH, 65°C Units may require bake-out after humidity to restore full performance.	MIL-STD-202, Method 103
Thermal Shock	-65° to 125°C, 5 cycles	MIL-STD-202, Method 107, Condition B
Vibration (High Frequency)	20g peak, 10-2000 Hz, 12 times in each of three perpendicular directions (total 36)	MIL-STD-202, Method 204, Condition D
Mechanical Shock	100g, 6ms sawtooth, 3 shocks each direction 3 axes (total 18)	MIL-STD-202, Method 213, Condition I