

Coaxial

Bandpass Filter

VBF-7200+

50Ω 7100 to 7300 MHz

The Big Deal

- Low Insertion Loss (2.0 dB typical)
- Good close-in rejection
- Versatile small size, coaxial, 1.43" length



CASE STYLE: FF704

Product Overview

The VBF-7200+ Band Pass Filter is constructed using internal LTCC Band Pass Filter structure to achieve repeatable performance. Covering 7200 MHz \pm 100 MHz, these units offer low insertion loss and good rejection at the band reject edges. Built using Mini-Circuits proven unibody construction which integrates the RF connectors with the case body, the VBF-7200+ takes very little space and meets rugged test lab system environment.

Key Features

| Feature | Advantages |
|--------------------------------------|--|
| Good Rejection close to pass band | Provides good rejection of signals close to the pass band, for improved system performance. |
| Compact Versatile Case (1.43"x0.41") | Enables use in a variety of applications including space constrained connectorized systems. Connectors: SMA Female (1), SMA Male (1) |
| Rugged Unibody Construction | Mini-Circuits Unibody construction allows survivability in critical applications including militarized or industrial systems. |

Notes

- A. Performance and quality attributes and conditions not expressly stated in this specification document are intended to be excluded and do not form a part of this specification document.
B. Electrical specifications and performance data contained in this specification document are based on Mini-Circuit's applicable established test performance criteria and measurement instructions.
C. The parts covered by this specification document are subject to Mini-Circuits standard limited warranty and terms and conditions (collectively, "Standard Terms"); Purchasers of this part are entitled to the rights and benefits contained therein. For a full statement of the Standard Terms and the exclusive rights and remedies thereunder, please visit Mini-Circuits' website at www.minicircuits.com/MCLStore/terms.jsp



Bandpass Filter

VBF-7200+

50Ω 7100 to 7300 MHz



Maximum Ratings

| | |
|-----------------------|-----------------|
| Operating Temperature | -55°C to 100°C |
| Storage Temperature | -55°C to 100°C |
| RF Power Input* | 2W max. at 25°C |

*Passband rating, derate linearly to 0.5W at 100°C ambient
Permanent damage may occur if any of these limits are exceeded.

Features

- Small size
- Temperature stable
- Rugged unibody construction

CASE STYLE: FF704

| | |
|------------|-----------|
| Connectors | Model |
| SMA | VBF-7200+ |

Applications

- Harmonic Rejection
- Transmitters / Receivers

+RoHS Compliant

The +Suffix identifies RoHS Compliance. See our web site for RoHS Compliance methodologies and qualifications

Electrical Specifications at 25°C

| Parameter | F# | Frequency (MHz) | Min. | Typ. | Max. | Unit | |
|------------------|------------------|-----------------|------------|------|------|------|----|
| Pass Band | Center Frequency | — | — | 7200 | — | MHz | |
| | Insertion Loss | F1-F2 | 7100-7300 | — | 2.0 | 3.5 | dB |
| | VSWR | F1-F2 | 7100-7300 | — | 2.5 | — | :1 |
| Stop Band, Lower | Insertion Loss | DC-F3 | DC-6500 | — | 15 | — | dB |
| | VSWR | DC-F3 | DC-6500 | — | 30 | — | :1 |
| Stop Band, Upper | Insertion Loss | F4-F5 | 8400-13800 | — | 20 | — | dB |
| | VSWR | F4-F5 | 8400-13800 | — | 30 | — | :1 |

Outline Drawing

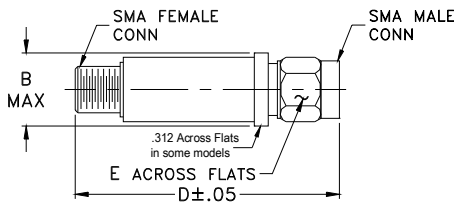

Outline Dimensions (inch/mm)

| | | | |
|-------|-------|------|-------|
| B | D | E | wt |
| .410 | 1.43 | .312 | grams |
| 10.41 | 36.32 | 7.92 | 10.0 |

Typical Frequency Response

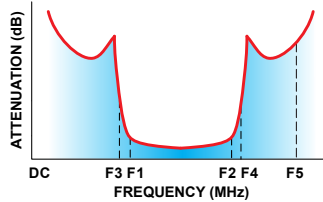

Functional Schematic

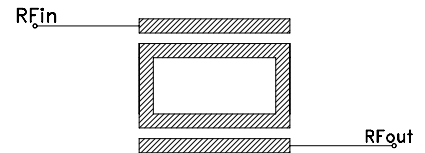

Typical Performance Data at 25°C

| Frequency (MHz) | Insertion Loss (dB) | VSWR (:1) |
|-----------------|---------------------|-----------|
| 100.00 | 44.36 | 1737.18 |
| 800.00 | 26.49 | 347.44 |
| 1500.00 | 21.53 | 157.93 |
| 2550.00 | 18.08 | 78.97 |
| 5000.00 | 14.82 | 34.07 |
| 6050.00 | 15.61 | 37.77 |
| 6750.00 | 8.29 | 4.39 |
| 7100.00 | 1.91 | 1.37 |
| 7300.00 | 1.74 | 1.26 |
| 8000.00 | 11.32 | 11.85 |
| 10050.00 | 20.06 | 6.30 |
| 11050.00 | 23.36 | 9.69 |
| 12050.00 | 30.24 | 10.56 |
| 14050.00 | 19.54 | 7.17 |

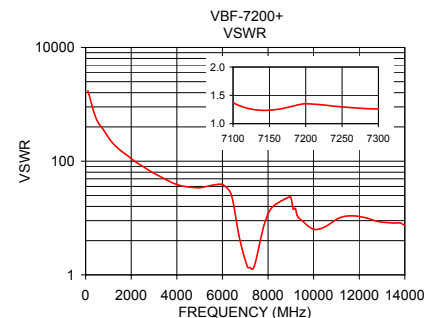
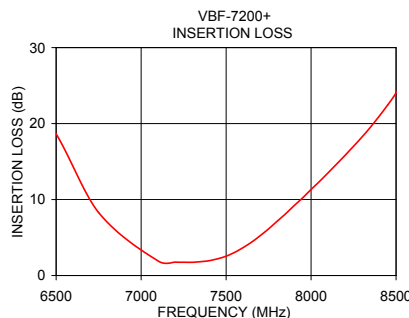
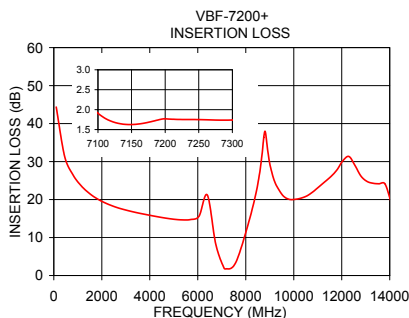

Notes

- Performance and quality attributes and conditions not expressly stated in this specification document are intended to be excluded and do not form a part of this specification document.
- Electrical specifications and performance data contained in this specification document are based on Mini-Circuit's applicable established test performance criteria and measurement instructions.
- The parts covered by this specification document are subject to Mini-Circuits standard limited warranty and terms and conditions (collectively, "Standard Terms"); Purchasers of this part are entitled to the rights and benefits contained therein. For a full statement of the Standard Terms and the exclusive rights and remedies thereunder, please visit Mini-Circuits' website at www.minicircuits.com/MCLStore/terms.jsp



Coaxial Bandpass Filter

VBF-7200+

Typical Performance Data

| FREQUENCY (MHz) | INSERTION LOSS (dB) | RETURN LOSS (dB) | GROUP DELAY (ns) |
|--------------------|------------------------|---------------------|---------------------|
| 100.0 | 44.36 | 0.01 | 0.26 |
| 450.0 | 31.36 | 0.03 | 0.26 |
| 800.0 | 26.49 | 0.05 | 0.27 |
| 1150.0 | 23.55 | 0.08 | 0.26 |
| 1500.0 | 21.53 | 0.11 | 0.26 |
| 1850.0 | 20.05 | 0.14 | 0.26 |
| 2200.0 | 18.94 | 0.18 | 0.26 |
| 2550.0 | 18.08 | 0.22 | 0.26 |
| 2900.0 | 17.41 | 0.27 | 0.25 |
| 3250.0 | 16.84 | 0.32 | 0.25 |
| 3600.0 | 16.36 | 0.38 | 0.25 |
| 3950.0 | 15.92 | 0.44 | 0.25 |
| 4300.0 | 15.51 | 0.48 | 0.25 |
| 4650.0 | 15.13 | 0.50 | 0.25 |
| 5000.0 | 14.82 | 0.51 | 0.26 |
| 5350.0 | 14.66 | 0.48 | 0.26 |
| 5700.0 | 14.75 | 0.45 | 0.27 |
| 6400.0 | 21.17 | 0.70 | 0.15 |
| 6750.0 | 8.29 | 4.03 | 0.57 |
| 7100.0 | 1.91 | 16.13 | 0.75 |
| 7200.0 | 1.77 | 16.50 | 0.67 |
| 7300.0 | 1.74 | 18.79 | 0.67 |
| 7400.0 | 1.95 | 14.84 | 0.68 |
| 7500.0 | 2.55 | 9.34 | 0.68 |
| 7600.0 | 3.67 | 5.81 | 0.65 |
| 7700.0 | 5.24 | 3.74 | 0.58 |
| 7750.0 | 6.14 | 3.08 | 0.55 |
| 7800.0 | 7.14 | 2.53 | 0.51 |
| 7900.0 | 9.18 | 1.87 | 0.44 |
| 8000.0 | 11.32 | 1.47 | 0.39 |
| 8100.0 | 13.52 | 1.25 | 0.36 |
| 8150.0 | 14.66 | 1.17 | 0.32 |
| 8200.0 | 15.82 | 1.11 | 0.32 |
| 8300.0 | 18.25 | 1.02 | 0.29 |
| 8400.0 | 20.94 | 0.97 | 0.25 |
| 8500.0 | 24.02 | 0.91 | 0.20 |
| 8550.0 | 25.84 | 0.88 | 0.13 |
| 8600.0 | 27.87 | 0.86 | 0.06 |
| 9050.0 | 28.04 | 0.92 | 0.19 |
| 9100.0 | 26.83 | 1.22 | 0.28 |
| 9200.0 | 24.81 | 1.18 | 0.17 |
| 9300.0 | 23.42 | 1.63 | 0.30 |
| 9800.0 | 20.08 | 2.50 | 0.33 |
| 10050.0 | 20.06 | 2.78 | 0.30 |
| 10300.0 | 20.37 | 2.70 | 0.29 |
| 10800.0 | 22.03 | 2.09 | 0.27 |
| 11300.0 | 24.69 | 1.65 | 0.21 |
| 11800.0 | 27.82 | 1.60 | 0.19 |
| 12800.0 | 26.19 | 2.00 | 0.24 |
| 13300.0 | 24.29 | 2.11 | 0.36 |
| 13800.0 | 24.16 | 2.14 | 0.27 |
| 14050.0 | 19.54 | 2.44 | 0.52 |



P.O. Box 350166, Brooklyn, New York 11235-0003 • Fax (718) 934-4500 • Fax (718) 332-4661 For detailed performance specs & shopping online see Mini-Circuits web site
The Design Engineers Search Engine Provides ACTUAL Data Instantly From MINI-CIRCUITS At: www.minicircuits.com



IF/RF MICROWAVE COMPONENTS

REV. X1
VBF-7200+
1/25/2011
Page 1 of 1

Typical Performance Curves

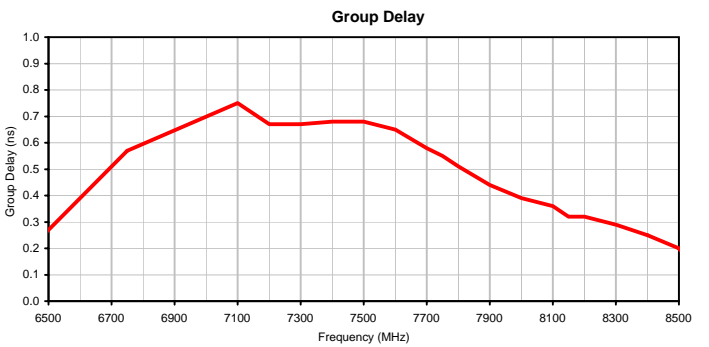
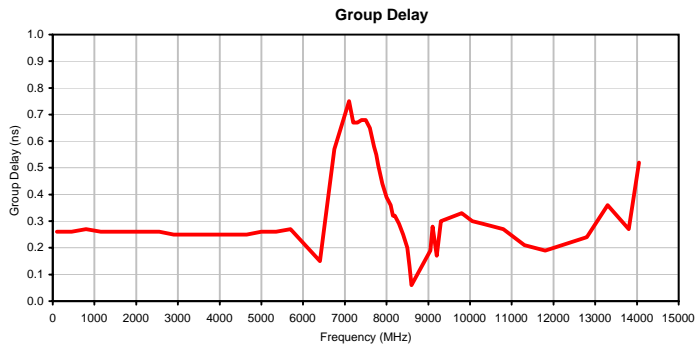
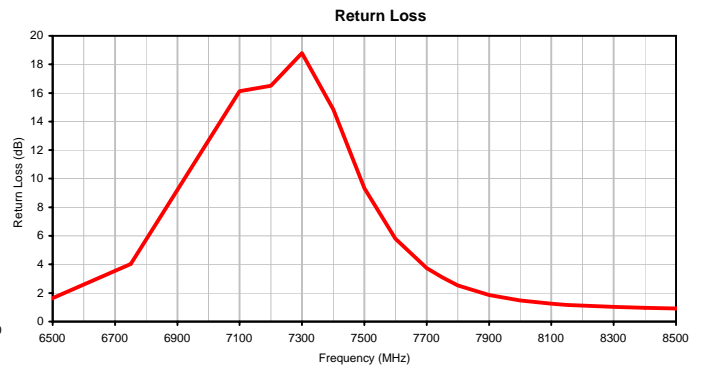
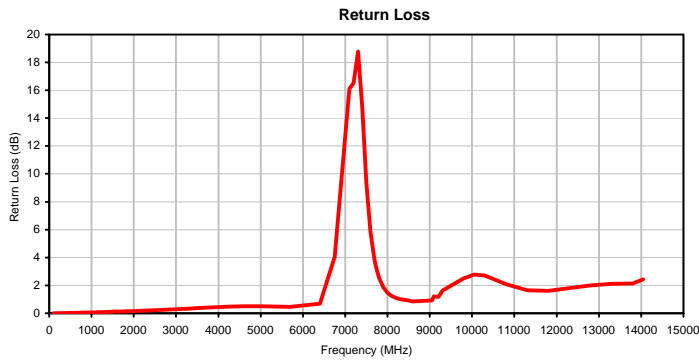
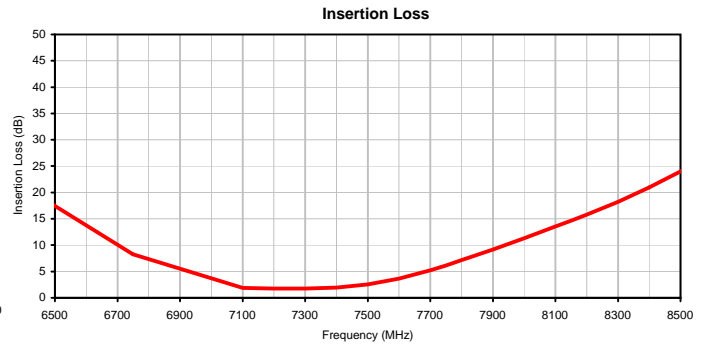

Case Style

FF

FF704

Outline Dimensions

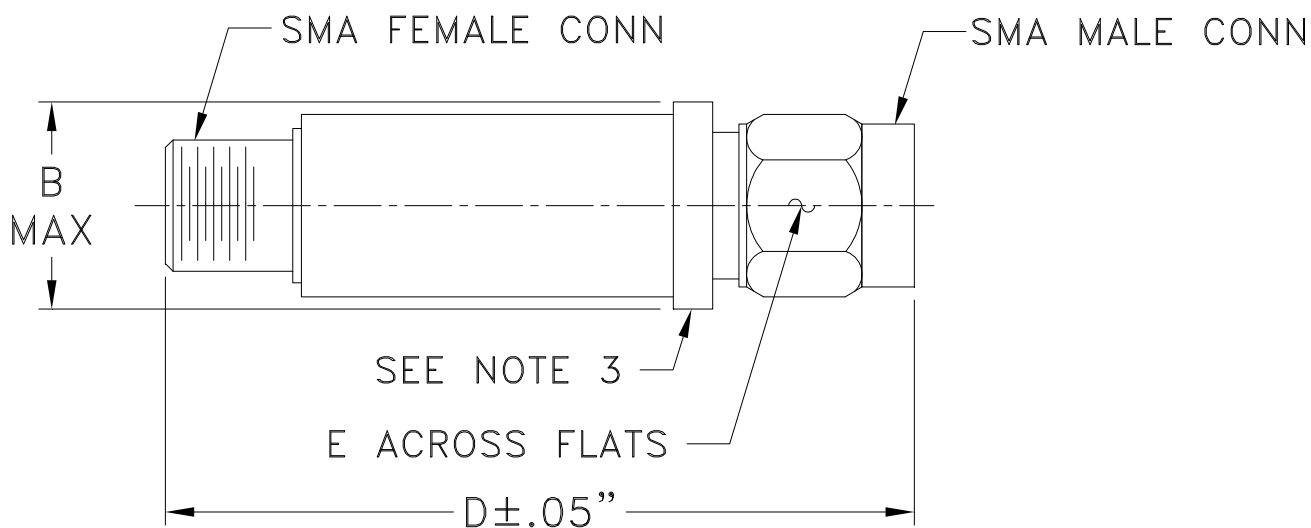

| CASE #. | A | B | C | D | E | WT GRAMS |
|---------|----|-----------------|----|-----------------|----------------|----------|
| FF704 | -- | .410 (10.41) | -- | 1.43 (36.32) | .312 (7.92) | 10.0 |

Dimensions are in inches (mm). Tolerances: 2Pl. ± .04; 3Pl. ± .030

Notes:

1. Case material: Stainless steel.
2. Case finish: Gold plated.
3. Round Flange may have .312 Across Flats in some models.

Mini-Circuits®
ISO 9001 ISO 14001 CERTIFIED

ALL NEW
minicircuits.com

P.O. Box 350166, Brooklyn, New York 11235-0003 (718) 934-4500 Fax (718) 332-4661 For detailed performance specs & shopping online see Mini-Circuits web site



The Design Engineers Search Engine Provides ACTUAL Data Instantly From MINI-CIRCUITS At: www.minicircuits.com

RF/IF MICROWAVE COMPONENTS



All Mini-Circuits products are manufactured under exacting quality assurance and control standards, and are capable of meeting published specifications after being subjected to any or all of the following physical and environmental test.

| Specification | Test/Inspection Condition | Reference/Spec |
|----------------------------|--|--------------------------------------|
| Operating Temperature | -55° to 100°C Ambient Environment | Individual Model Data Sheet |
| Storage Temperature | -55° to 100° C Ambient Environment | Individual Model Data Sheet |
| Barometric Pressure | 100,000 Feet | MIL-STD-202, Method 105, Condition D |
| Humidity | 90% RH, 65°C Units may require bake-out after humidity to restore full performance. | MIL-STD-202, Method 103 |
| Thermal Shock | -65° to 125°C, 5 cycles | MIL-STD-202, Method 107, Condition B |
| Vibration (High Frequency) | 20g peak, 10-2000 Hz, 12 times in each of three perpendicular directions (total 36) | MIL-STD-202, Method 204, Condition D |
| Mechanical Shock | 100g, 6ms sawtooth, 3 shocks each direction 3 axes (total 18) | MIL-STD-202, Method 213, Condition I |