

Coaxial

Bandpass Filter

VBF-1840+

50Ω 1750 to 1930 MHz

The Big Deal

- Low Insertion Loss (2.0 dB typical)
- Good close-in rejection
- Versatile small size, coaxial, 1.43" length



CASE STYLE: FF704

Product Overview

The VBF-1840+ Band Pass Filter is constructed using internal LTCC Band Pass Filter structure to achieve repeatable performance. Covering 1840 MHz \pm 90 MHz, these units offer low insertion loss and good rejection at the band reject edges. Built using Mini-Circuits proven unibody construction which integrates the RF connectors with the case body, the VBF-1840+ takes very little space and meets rugged test lab system environment.

Key Features

Feature	Advantages
Good Rejection close to pass band	Provides good rejection of signals close to the pass band, for improved system performance.
Compact Versatile Case (1.43"x0.41")	Enables use in a variety of applications including space constrained connectorized systems. Connectors: SMA Female (1), SMA Male (1)
Rugged Unibody Construction	Mini-Circuits Unibody construction allows survivability in critical applications including militarized or industrial systems.

Notes

- A. Performance and quality attributes and conditions not expressly stated in this specification document are intended to be excluded and do not form a part of this specification document.
B. Electrical specifications and performance data contained in this specification document are based on Mini-Circuit's applicable established test performance criteria and measurement instructions.
C. The parts covered by this specification document are subject to Mini-Circuits standard limited warranty and terms and conditions (collectively, "Standard Terms"); Purchasers of this part are entitled to the rights and benefits contained therein. For a full statement of the Standard Terms and the exclusive rights and remedies thereunder, please visit Mini-Circuits' website at www.minicircuits.com/MCLStore/terms.jsp



Bandpass Filter

VBF-1840+

50Ω 1750 to 1930 MHz



Maximum Ratings

Operating Temperature	-55°C to 100°C
Storage Temperature	-55°C to 100°C
RF Power Input*	1.5W max. at 25°C

*Passband rating, derate linearly to 0.25W at 100°C ambient
Permanent damage may occur if any of these limits are exceeded.

Features

- Small size
- Temperature stable
- Rugged unibody construction

CASE STYLE: FF704

Connectors	Model
SMA	VBF-1840+

Applications

- Harmonic Rejection
- Transmitters / Receivers

+RoHS Compliant

The +Suffix identifies RoHS Compliance. See our web site for RoHS Compliance methodologies and qualifications

Outline Drawing

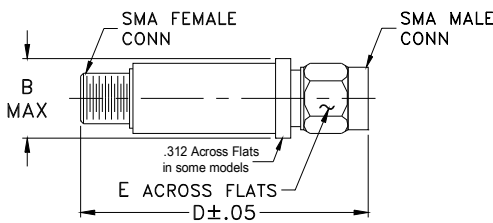

Electrical Specifications at 25°C

Parameter	F#	Frequency (MHz)	Min.	Typ.	Max.	Unit	
Pass Band	Center Frequency	—	—	1840	—	MHz	
	Insertion Loss	F1-F2	1750-1930	—	—	3.0	dB
	VSWR	F1-F2	1750-1930	—	—	2.5	:1
Stop Band, Lower	Insertion Loss	DC-F3	DC-1460	—	20	dB	
	VSWR	DC-F3	DC-1460	—	25	:1	
Stop Band, Upper	Insertion Loss	F4-F5	3500-5700	—	25	dB	
	VSWR	F4-F5	3500-5700	—	20	:1	

Typical Frequency Response

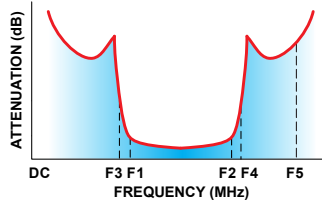

Functional Schematic

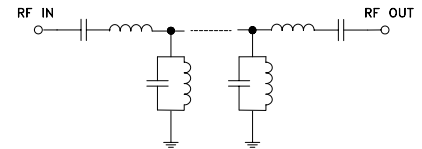

Outline Dimensions (inch/mm)

B	D	E	
.410	1.43	.312	gra
10.41	36.32	7.92	1'

Typical Performance Data at 25°C

Frequency (MHz)	Insertion Loss (dB)	VSWR (:1)
0.30	68.03	2723.20
100.00	23.50	211.11
300.00	30.09	115.03
1000.00	35.23	71.14
1300.00	45.92	49.79
1450.00	24.19	30.25
1750.00	2.09	1.70
1880.00	1.73	1.08
1950.00	2.28	1.77
2850.00	21.69	61.29
3400.00	29.13	64.76
3800.00	36.64	58.75
4100.00	50.84	54.08
5100.00	34.05	43.97
5700.00	31.08	27.72

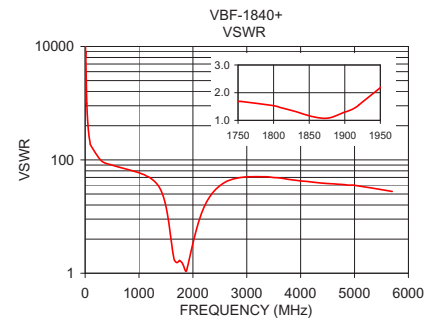
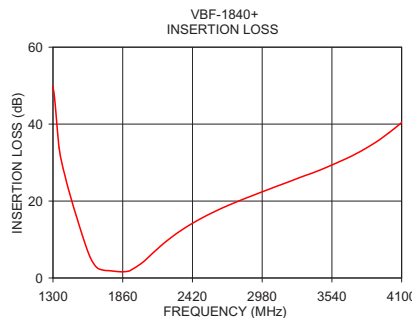
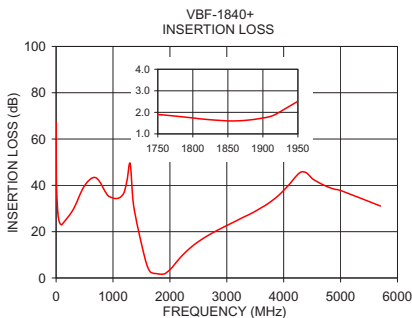

Notes

- Performance and quality attributes and conditions not expressly stated in this specification document are intended to be excluded and do not form a part of this specification document.
- Electrical specifications and performance data contained in this specification document are based on Mini-Circuit's applicable established test performance criteria and measurement instructions.
- The parts covered by this specification document are subject to Mini-Circuit's standard limited warranty and terms and conditions (collectively, "Standard Terms"); Purchasers of this part are entitled to the rights and benefits contained therein. For a full statement of the Standard Terms and the exclusive rights and remedies thereunder, please visit Mini-Circuit's website at www.minicircuits.com/MCLStore/terms.jsp



Typical Performance Data

FREQUENCY	INSERTION LOSS	RETURN LOSS
(MHz)	(dB)	(dB)
0.3	68.03	0.01
0.7	60.17	0.00
1.0	57.11	0.00
3.0	47.65	0.00
7.0	40.34	0.00
10.0	37.27	0.00
30.0	28.44	0.02
100.0	23.50	0.08
300.0	30.09	0.15
1000.0	35.23	0.24
1100.0	34.77	0.26
1200.0	36.29	0.30
1300.0	45.92	0.35
1350.0	40.50	0.39
1400.0	30.82	0.46
1450.0	24.19	0.57
1500.0	18.53	0.80
1600.0	8.26	2.61
1700.0	2.53	11.51
1750.0	2.09	11.75
1780.0	1.99	11.66
1800.0	1.93	12.17
1910.0	1.84	20.95
1950.0	2.28	11.14
2050.0	4.81	3.68
2250.0	10.84	0.94
2450.0	15.34	0.48
2550.0	17.16	0.39
2650.0	18.79	0.34
2750.0	20.29	0.30
2850.0	21.69	0.28
2950.0	23.04	0.27
3100.0	25.04	0.27
3300.0	27.71	0.26
3500.0	30.66	0.27
3700.0	34.36	0.29
3900.0	39.67	0.31
4000.0	43.75	0.31
4100.0	50.84	0.32
4300.0	48.14	0.34
4500.0	40.32	0.35
4700.0	36.87	0.36
4900.0	34.93	0.38
5000.0	34.38	0.39
5100.0	34.05	0.40
5300.0	34.39	0.42
5500.0	37.09	0.46
5700.0	31.08	0.63
5900.0	16.98	1.70
6000.0	15.29	1.49

Typical Performance Curves

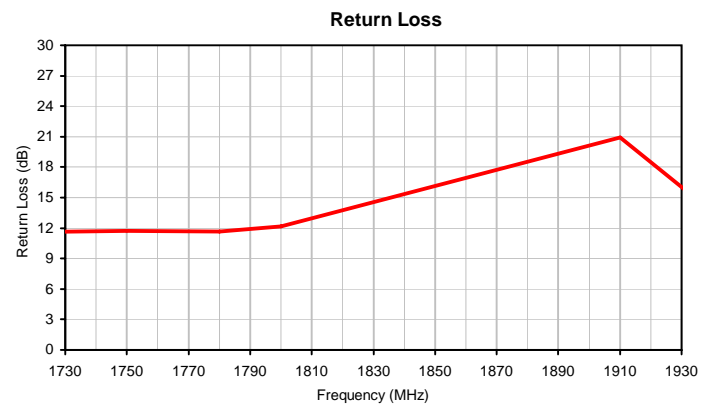
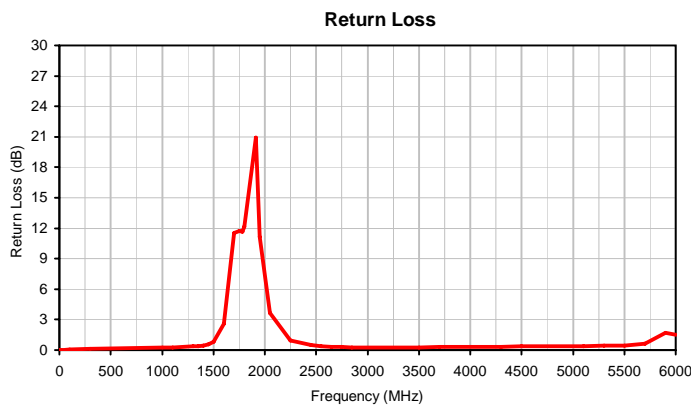
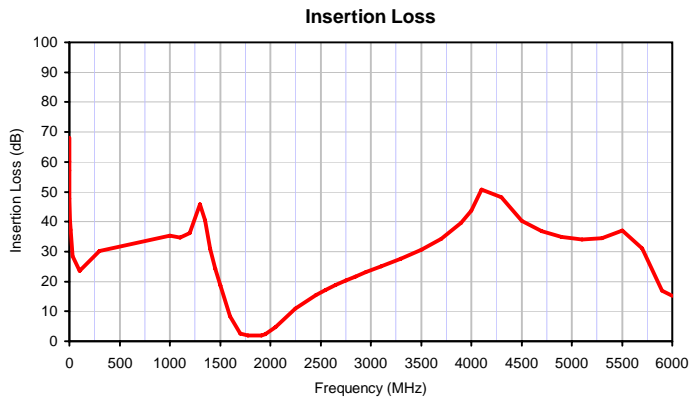

Case Style

FF

FF704

Outline Dimensions

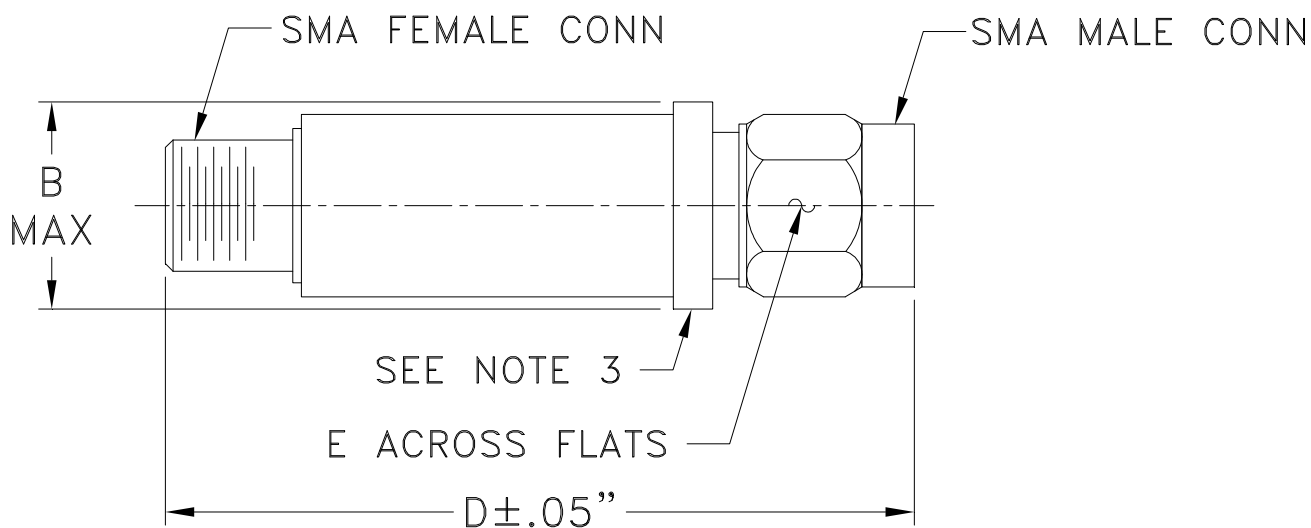

CASE #.	A	B	C	D	E	WT GRAMS
FF704	--	.410 (10.41)	--	1.43 (36.32)	.312 (7.92)	10.0

Dimensions are in inches (mm). Tolerances: 2Pl. ± .04; 3Pl. ± .030

Notes:

1. Case material: Stainless steel.
2. Case finish: Gold plated.
3. Round Flange may have .312 Across Flats in some models.

Mini-Circuits®
ISO 9001 ISO 14001 CERTIFIED

ALL NEW
minicircuits.com

P.O. Box 350166, Brooklyn, New York 11235-0003 (718) 934-4500 Fax (718) 332-4661 For detailed performance specs & shopping online see Mini-Circuits web site



The Design Engineers Search Engine Provides ACTUAL Data Instantly From MINI-CIRCUITS At: www.minicircuits.com

RF/IF MICROWAVE COMPONENTS

All Mini-Circuits products are manufactured under exacting quality assurance and control standards, and are capable of meeting published specifications after being subjected to any or all of the following physical and environmental test.

Specification	Test/Inspection Condition	Reference/Spec
Operating Temperature	-55° to 100°C Ambient Environment	Individual Model Data Sheet
Storage Temperature	-55° to 100° C Ambient Environment	Individual Model Data Sheet
Barometric Pressure	100,000 Feet	MIL-STD-202, Method 105, Condition D
Humidity	90% RH, 65°C Units may require bake-out after humidity to restore full performance.	MIL-STD-202, Method 103
Thermal Shock	-65° to 125°C, 5 cycles	MIL-STD-202, Method 107, Condition B
Vibration (High Frequency)	20g peak, 10-2000 Hz, 12 times in each of three perpendicular directions (total 36)	MIL-STD-202, Method 204, Condition D
Mechanical Shock	100g, 6ms sawtooth, 3 shocks each direction 3 axes (total 18)	MIL-STD-202, Method 213, Condition I