

Coaxial SMA Fixed Attenuator

50Ω 1W 7dB DC to 6000 MHz

VAT-7+



Generic photo used for illustration purposes only

CASE STYLE: FF704

Connectors	Model
SMA	VAT-7+

+RoHS Compliant

The +Suffix identifies RoHS Compliance. See our web site for RoHS Compliance methodologies and qualifications

Maximum Ratings

Operating Temperature	-45°C to 100°C
Storage Temperature	-55°C to 100°C

Permanent damage may occur if any of these limits are exceeded.

Features

- wideband coverage, DC to 6000 MHz
- 1 watt rating
- rugged unibody construction
- off-the-shelf availability
- very low cost

Applications

- impedance matching
- signal level adjustment

Outline Drawing

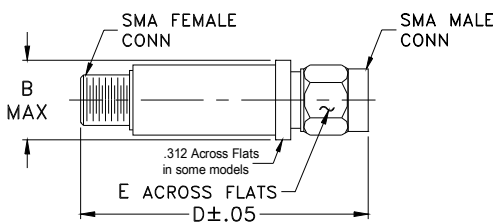

Outline Dimensions (inch/mm)

B	D	E	wt
.410	1.43	.312	grams
10.41	36.32	7.92	10.0

Electrical Specifications

FREQ. RANGE (MHz)	ATTENUATION * (dB)					VSWR (:1)					MAX. INPUT POWER (W)
	Flatness **										
	DC-3 GHz	3-5 GHz	5-6 GHz	DC-6 GHz		DC-3 GHz	3-5 GHz	5-6 GHz			
f_L-f_U	Nom.	Typ.	Typ.	Typ.	Typ.	Typ.	Max.	Typ.	Max.	Typ.	
DC-6000	7±0.3	0.10	0.10	0.10	0.10	1.05	1.20	1.15	1.40	1.40	1.0

* Attenuation varies by 0.3 dB max. over temperature.

** Flatness= variation over band divided by 2.

Typical Performance Data

Frequency (MHz)	Attenuation (dB)	VSWR (:1)
0.03	6.99	1.00
50.00	6.98	1.00
100.00	6.99	1.00
500.00	7.02	1.01
1000.00	7.04	1.01
2000.00	7.05	1.01
3000.00	7.05	1.05
4000.00	7.01	1.12
5000.00	7.01	1.24
6000.00	7.09	1.40

Electrical Schematic

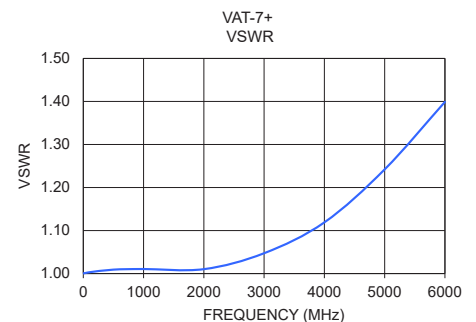
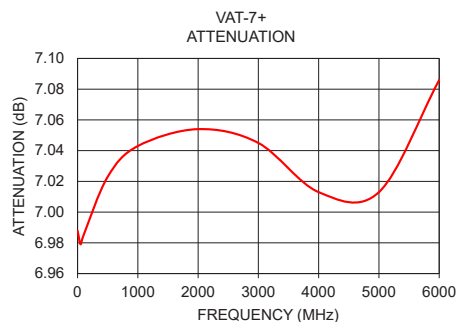
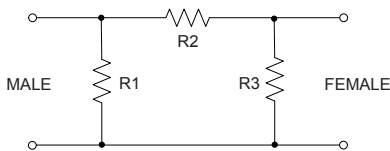

Notes

- Performance and quality attributes and conditions not expressly stated in this specification document are intended to be excluded and do not form a part of this specification document.
- Electrical specifications and performance data contained in this specification document are based on Mini-Circuit's applicable established test performance criteria and measurement instructions.
- The parts covered by this specification document are subject to Mini-Circuits standard limited warranty and terms and conditions (collectively, "Standard Terms"); Purchasers of this part are entitled to the rights and benefits contained therein. For a full statement of the Standard Terms and the exclusive rights and remedies thereunder, please visit Mini-Circuits' website at www.minicircuits.com/WCLStore/terms.jsp



Typical Performance Data

FREQUENCY (MHz)	ATTENUATION (dB)	RETURN LOSS (dB)
0.03	6.99	71.43
50.00	6.98	61.21
100.00	6.99	56.29
500.00	7.02	46.80
1000.00	7.04	45.56
2000.00	7.05	45.83
3000.00	7.05	32.72
4000.00	7.01	25.01
5000.00	7.01	19.33
6000.00	7.09	15.58

REV. X1
VAT-7+
061109
Page 1 of 1



IF/RF MICROWAVE COMPONENTS • ISO 9001 ISO 14001 AS 9100 CERTIFIED RoHS compliant
P.O. Box 350166, Brooklyn, New York 11235-0003 (718) 934-4500 Fax (718) 332-4661



The Design Engineers Search Engine finds the model you need, Instantly • For detailed performance specs & shopping online see



Typical Performance Curves

Attenuation

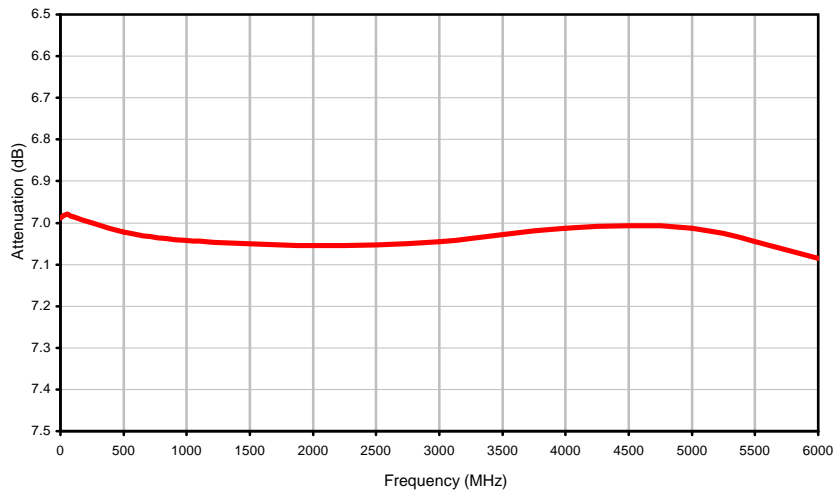

Return Loss

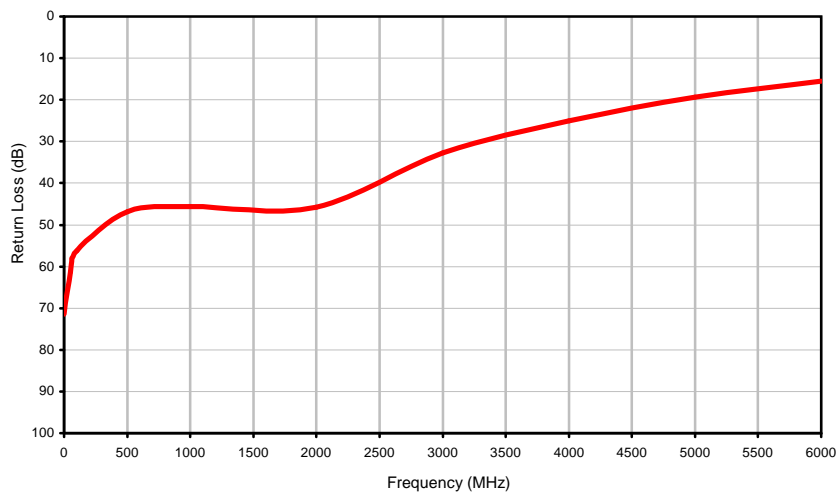

REV. X1
VAT-7+
061109
Page 1 of 1



IF/RF MICROWAVE COMPONENTS • ISO 9001 ISO 14001 AS 9100 CERTIFIED RoHS compliant
P.O. Box 350166, Brooklyn, New York 11235-0003 (718) 934-4500 Fax (718) 332-4661



The Design Engineers Search Engine finds the model you need, Instantly • For detailed performance specs & shopping online see



Case Style

FF

FF704

Outline Dimensions

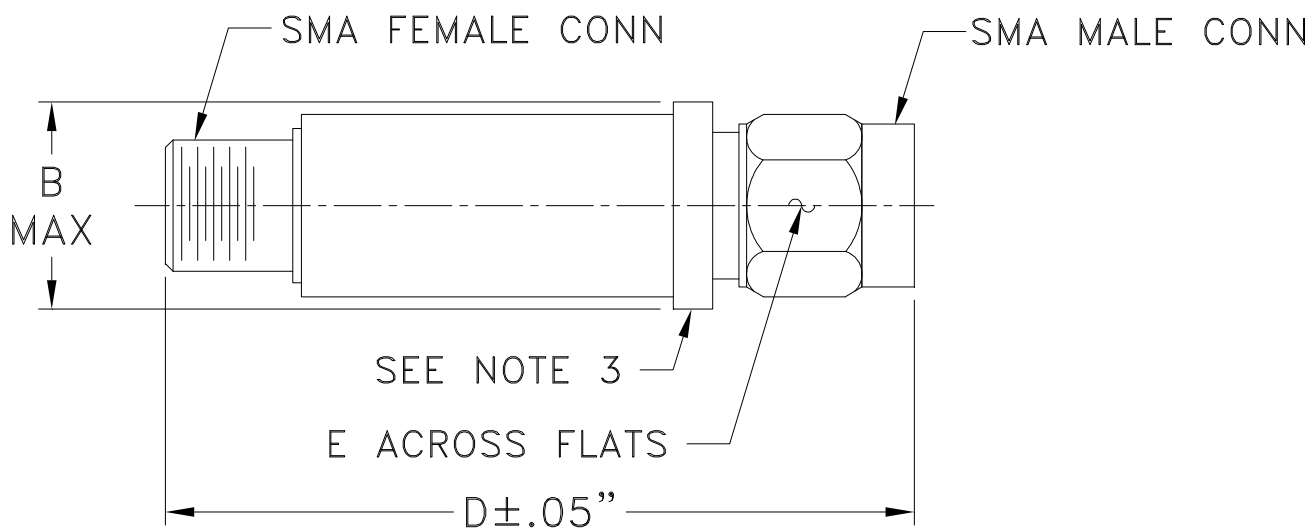

CASE #.	A	B	C	D	E	WT GRAMS
FF704	--	.410 (10.41)	--	1.43 (36.32)	.312 (7.92)	10.0

Dimensions are in inches (mm). Tolerances: 2Pl. ± .04; 3Pl. ± .030

Notes:

1. Case material: Stainless steel.
2. Case finish: Gold plated.
3. Round Flange may have .312 Across Flats in some models.

Mini-Circuits®
ISO 9001 ISO 14001 CERTIFIED

ALL NEW
minicircuits.com

P.O. Box 350166, Brooklyn, New York 11235-0003 (718) 934-4500 Fax (718) 332-4661 For detailed performance specs & shopping online see Mini-Circuits web site



The Design Engineers Search Engine Provides ACTUAL Data Instantly From MINI-CIRCUITS At: www.minicircuits.com

RF/IF MICROWAVE COMPONENTS



All Mini-Circuits products are manufactured under exacting quality assurance and control standards, and are capable of meeting published specifications after being subjected to any or all of the following physical and environmental test.

Specification	Test/Inspection Condition	Reference/Spec
Operating Temperature	-45° to 100° C Ambient Environment	Individual Model Data Sheet
Storage Temperature	-55° to 100° C Ambient Environment	Individual Model Data Sheet
Barometric Pressure	100,000 Feet	MIL-STD-202, Method 105, Condition D
Humidity	90% RH, 65°C Units may require bake-out after humidity to restore full performance.	MIL-STD-202, Method 103
Thermal Shock	-65° to 125°C, 5 cycles	MIL-STD-202, Method 107, Condition B
Vibration (High Frequency)	20g peak, 10-2000 Hz, 12 times in each of three perpendicular directions (total 36)	MIL-STD-202, Method 204, Condition D
Mechanical Shock	100g, 6ms sawtooth, 3 shocks each direction 3 axes (total 18)	MIL-STD-202, Method 213, Condition I