



COAXIAL

# Fixed Attenuator

VAT-A-SERIES

Mini-Circuits

50Ω

Up to 2W

DC to 6000 MHz

## THE BIG DEAL

- Wideband coverage, DC to 6000 MHz
- Up to 2 watt rating
- Rugged unibody construction
- Excellent VSWR
- Excellent flatness

## APPLICATIONS

- Signal level adjustment
- Impedance matching



Generic photo used for illustration purposes only

Model No.	VAT-A-SERIES
Case Style	FF704
Connectors	SMA

### +RoHS Compliant

The +Suffix identifies RoHS Compliance. See our web site for RoHS Compliance methodologies and qualifications

## PRODUCT OVERVIEW

Mini-Circuits' VAT-A series are fixed attenuators from DC to 6000 MHz frequency range with excellent flatness in attenuation. VAT-A series is available with nominal attenuation of 1 to 30 dB. This attenuator series support testing and measurement application. Precise performance, excellent VSWR and rugged unibody construction makes the model ideal solution for systems requiring precise attenuation across very wide frequency range.

## KEY FEATURES

Feature	Advantages
Rugged construction	Excellent durability for a long lifetime of use
Up to 2 Watt rating	Good power handling
Excellent VSWR	Well-matched for 50 Ω systems
Flat attenuation	Good performance over the band.



COAXIAL

# Fixed Attenuator

VAT-5A+

## MAXIMUM RATINGS

Operating Temperature	-45°C to 100°C
Storage Temperature	-55°C to 100°C

Permanent damage may occur if any of these limits are exceeded.

## OUTLINE DRAWING

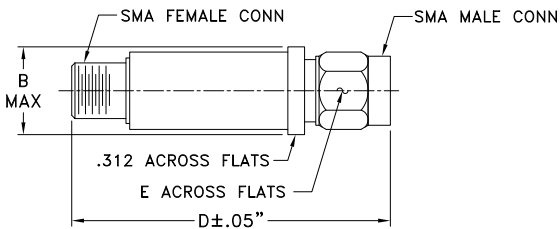

## OUTLINE DIMENSIONS (Inch/mm)

B	D	E	wt
.410	1.43	.312	grams
10.41	36.32	7.92	10.0

Note: Please refer to case style drawing for details

## ELECTRICAL SCHEMATIC

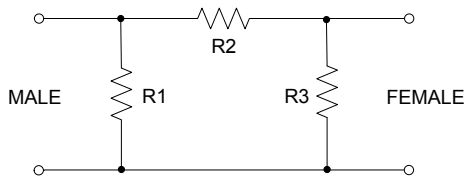

## ELECTRICAL SPECIFICATIONS AT 25°C

Parameter	Condition (MHz)	Min.	Typ.	Max.	Unit
Frequency Range		DC	-	6000	MHz
Attenuation <sup>1</sup> nominal <sup>3</sup>	10	-	5 ± 0.3	-	dB
Attenuation Flatness <sup>2</sup>	DC-3000	-	0.25	-	dB
	3000-5000	-	0.10	-	
	5000-6000	-	0.10	-	
	DC-6000	-	0.30	-	
VSWR	DC-3000	-	1.20	1.35	:1
	3000-5000	-	1.20	1.50	
	5000-6000	-	1.40	-	
Input Power <sup>4</sup>		-	-	1.4	W

1. Attenuation varies by 0.3 dB max. over temperature.
2. Flatness = variation over band divided by 2.
3. Nominal attenuation at 10 MHz
4. RF power at 25°C is 1.4W; Derate linearly to 1.0W at 85°C

## TYPICAL PERFORMANCE DATA

Frequency (MHz)	Attenuation (dB)	VSWR (:1)
10	4.92	1.08
100	4.93	1.08
500	4.99	1.08
900	5.02	1.08
1000	5.03	1.09
1400	5.06	1.09
1500	5.07	1.09
2000	5.10	1.10
2500	5.13	1.12
2800	5.14	1.13
3000	5.15	1.14
4000	5.19	1.17
4500	5.21	1.18
5000	5.23	1.18
6000	5.27	1.15

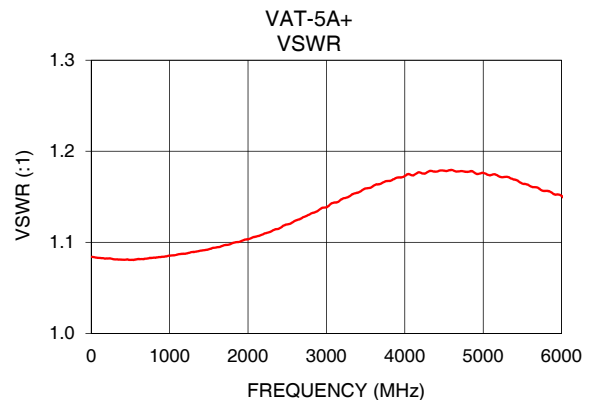
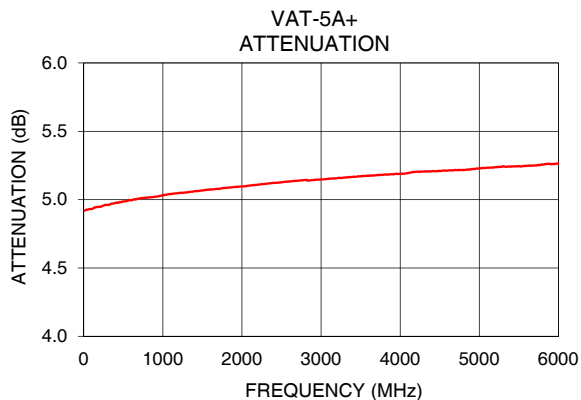

- NOTES
- Performance and quality attributes and conditions not expressly stated in this specification document are intended to be excluded and do not form a part of this specification document.
  - Electrical specifications and performance data contained in this specification document are based on Mini-Circuit's applicable established test performance criteria and measurement instructions.
  - The parts covered by this specification document are subject to Mini-Circuits standard limited warranty and terms and conditions (collectively, "Standard Terms"); Purchasers of this part are entitled to the rights and benefits contained therein. For a full statement of the standard. Terms and the exclusive rights and remedies thereunder, please visit Mini-Circuits' website at [www.minicircuits.com/MCLStore/terms.jsp](http://www.minicircuits.com/MCLStore/terms.jsp)



## Typical Performance Data

FREQ.	ATTENUATION	VSWR
(MHz)	(dB)	(dB)
10	4.92	1.08
20	4.92	1.08
50	4.93	1.08
100	4.93	1.08
200	4.95	1.08
300	4.96	1.08
400	4.98	1.08
500	4.99	1.08
600	4.99	1.08
700	5.01	1.08
800	5.01	1.08
900	5.02	1.08
1000	5.03	1.09
1100	5.04	1.09
1200	5.05	1.09
1300	5.05	1.09
1400	5.06	1.09
1500	5.07	1.09
1600	5.07	1.09
1700	5.08	1.10
1800	5.09	1.10
1900	5.09	1.10
2000	5.10	1.10
2100	5.10	1.11
2200	5.11	1.11
2300	5.12	1.11
2400	5.12	1.12
2500	5.13	1.12
2600	5.13	1.12
2700	5.14	1.13
2800	5.14	1.13
2900	5.14	1.14
3000	5.15	1.14
3100	5.15	1.14
3200	5.16	1.15
3300	5.16	1.15
3400	5.17	1.15
3500	5.17	1.16
3600	5.17	1.16
3700	5.18	1.16
3800	5.18	1.17
3900	5.19	1.17
4000	5.19	1.17
4100	5.20	1.17
4200	5.20	1.18
4300	5.21	1.18
4400	5.21	1.18
4500	5.21	1.18
4600	5.21	1.18
4700	5.22	1.18
4800	5.22	1.18
4900	5.22	1.18
5000	5.23	1.18
5100	5.23	1.17
5200	5.24	1.17
5300	5.24	1.17
5400	5.24	1.17
5500	5.24	1.16
5800	5.26	1.16
6000	5.27	1.15

## Typical Performance Curves

### ATTENUATION

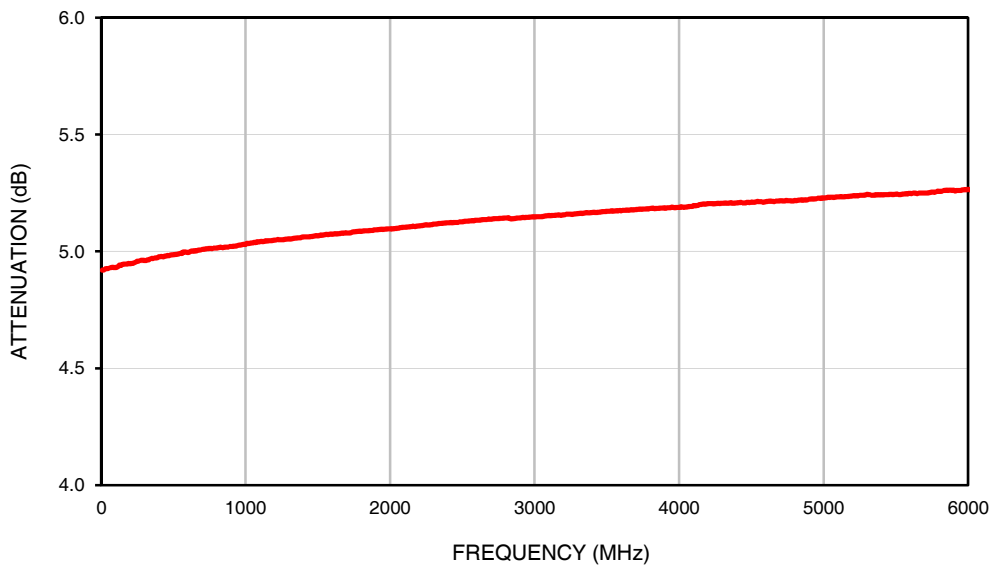

### VSWR

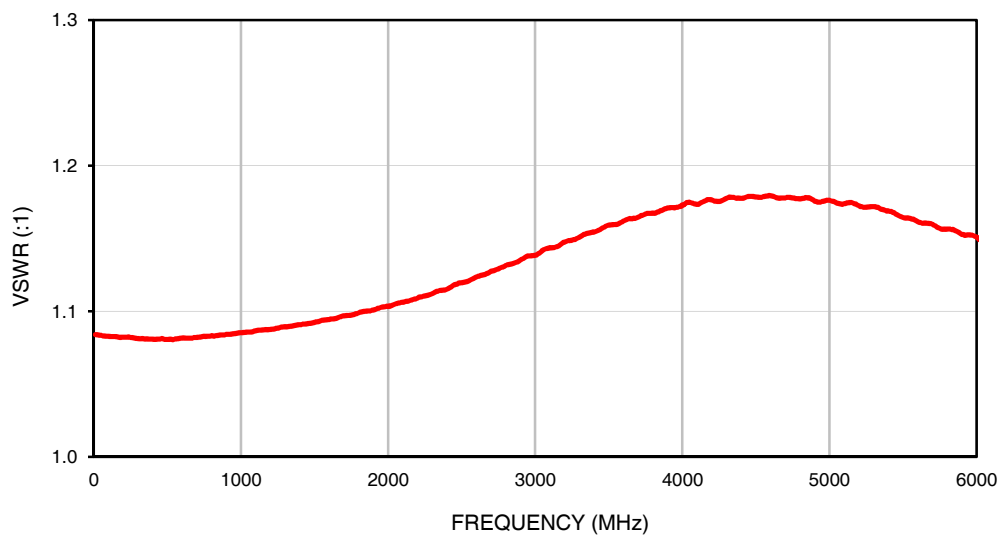

# Case Style

# FF

## FF704

### Outline Dimensions

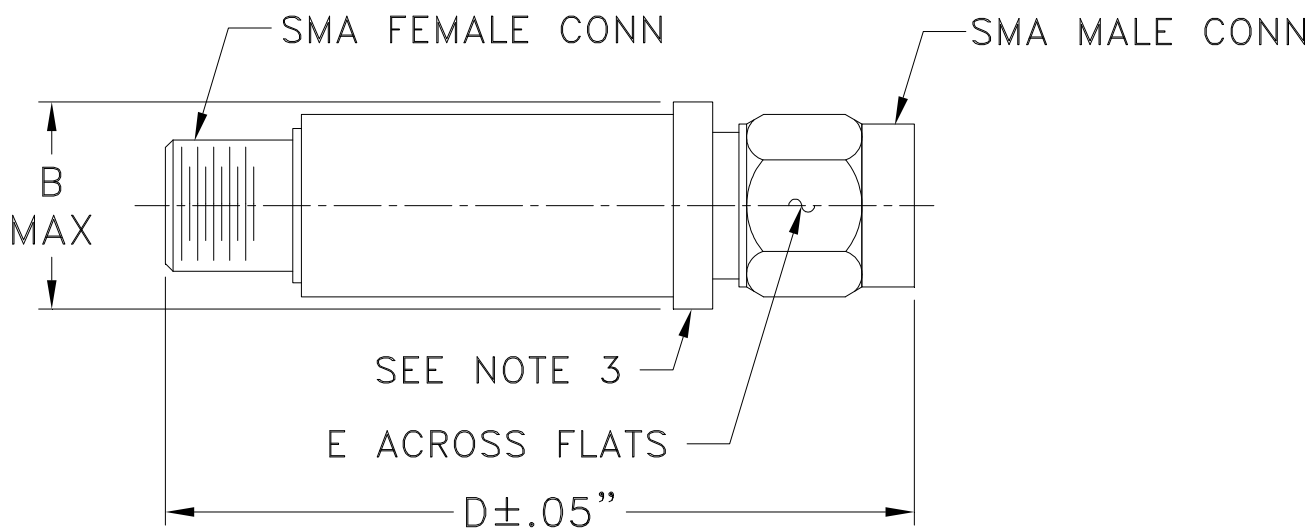

CASE #.	A	B	C	D	E	WT GRAMS
FF704	--	.410 (10.41)	--	1.43 (36.32)	.312 (7.92)	10.0

Dimensions are in inches (mm). Tolerances: 2Pl. ± .04; 3Pl. ± .030

#### Notes:

1. Case material: Stainless steel.
2. Case finish: Gold plated.
3. Round Flange may have .312 Across Flats in some models.

**Mini-Circuits**<sup>®</sup>  
ISO 9001 ISO 14001 CERTIFIED

ALL NEW  
minicircuits.com

P.O. Box 350166, Brooklyn, New York 11235-0003 (718) 934-4500 Fax (718) 332-4661 For detailed performance specs & shopping online see Mini-Circuits web site



The Design Engineers Search Engine Provides ACTUAL Data Instantly From MINI-CIRCUITS At: [www.minicircuits.com](http://www.minicircuits.com)

RF/IF MICROWAVE COMPONENTS

All Mini-Circuits products are manufactured under exacting quality assurance and control standards, and are capable of meeting published specifications after being subjected to any or all of the following physical and environmental test.

<b>Specification</b>	<b>Test/Inspection Condition</b>	<b>Reference/Spec</b>
Operating Temperature	-45° to 100° C Ambient Environment	Individual Model Data Sheet
Storage Temperature	-55° to 100° C Ambient Environment	Individual Model Data Sheet
Barometric Pressure	100,000 Feet	MIL-STD-202, Method 105, Condition D
Humidity	90% RH, 65°C Units may require bake-out after humidity to restore full performance.	MIL-STD-202, Method 103
Thermal Shock	-65° to 125°C, 5 cycles	MIL-STD-202, Method 107, Condition B
Vibration (High Frequency)	20g peak, 10-2000 Hz, 12 times in each of three perpendicular directions (total 36)	MIL-STD-202, Method 204, Condition D
Mechanical Shock	100g, 6ms sawtooth, 3 shocks each direction 3 axes (total 18)	MIL-STD-202, Method 213, Condition I