

Coaxial Matching Pad N-TYPE

50/75Ω

DC to 3000 MHz

UNMP-5075+ UNMP-5075



CASE STYLE: FF779

Connectors	Model
75ΩM-N	UNMP-5075(+)
50ΩF-N	

+RoHS Compliant

The +Suffix identifies RoHS Compliance. See our web site for RoHS Compliance methodologies and qualifications

Maximum Ratings

Operating Temperature -45°C to 100°C

Storage Temperature -55°C to 100°C

Permanent damage may occur if any of these limits are exceeded.

Features

- minimum loss pad
- wideband coverage, DC to 3000 MHz
- 0.5 watt rating
- rugged unibody construction
- off-the-shelf availability
- very low cost

Applications

- impedance matching

Outline Drawing

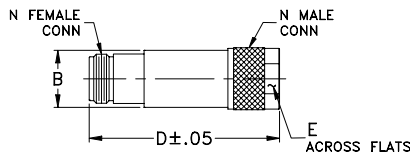

Outline Dimensions (inch/mm)

B	D	E	wt
.68	2.11	.718	grams
17.27	53.59	18.24	72.5

Electrical Schematic

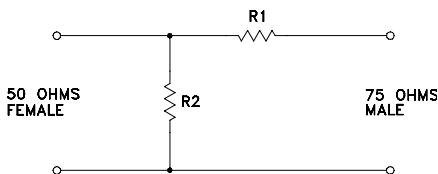

Electrical Specifications

FREQ. (MHz)	ATTENUATION * (dB)			VSWR (:1) Max.			POWER (W)
	Flatness** Max.						
f_L - f_U	Nom.	DC-100 MHz	100-1000 MHz	1000-3000 MHz	DC-100 MHz	100-1000 MHz	1000-3000 MHz
DC-3000	5.7±0.15	0.2	0.3	0.4	1.10	1.30	1.5

* Attenuation varies by 0.3 dB max. over temperature

** Flatness= variation over band divided by 2

Typical Performance Data

Frequency (MHz)	Attenuation (dB)	VSWR (:1)	
		50 Ω	75 Ω
1.00	5.80	1.00	1.00
5.00	5.80	1.00	1.00
10.00	5.80	1.00	1.00
50.00	5.84	1.00	1.01
100.00	5.86	1.00	1.01
300.00	5.88	1.01	1.03
500.00	5.88	1.02	1.05
800.00	5.88	1.04	1.07
1000.00	5.87	1.04	1.09
1200.00	5.81	1.05	1.11
1500.00	5.82	1.14	1.14
1800.00	5.79	1.17	1.17
2000.00	5.79	1.14	1.20
2600.00	5.64	1.36	1.30
3000.00	5.81	1.24	1.40

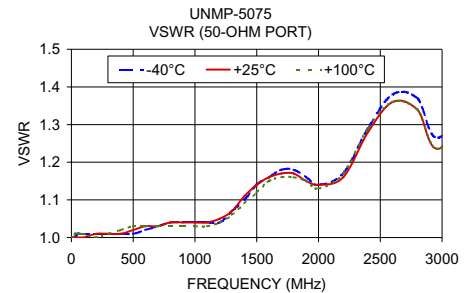
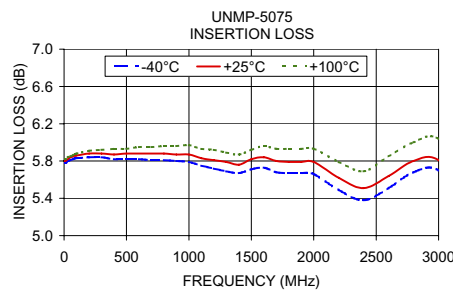

Notes

- Performance and quality attributes and conditions not expressly stated in this specification document are intended to be excluded and do not form a part of this specification document.
- Electrical specifications and performance data contained in this specification document are based on Mini-Circuit's applicable established test performance criteria and measurement instructions.
- The parts covered by this specification document are subject to Mini-Circuits standard limited warranty and terms and conditions (collectively, "Standard Terms"); Purchasers of this part are entitled to the rights and benefits contained therein. For a full statement of the Standard Terms and the exclusive rights and remedies thereunder, please visit Mini-Circuits' website at www.minicircuits.com/MCLStore/terms.jsp



www.minicircuits.com P.O. Box 350166, Brooklyn, NY 11235-0003 (718) 934-4500 sales@minicircuits.com

REV. B
M151107
ED-11538
UNMP-5075
WP/TD/CP/AM
150618

Matching Pad 50W/75W, N-Type

UNMP-5075

Typical Performance Data

FREQUENCY (MHz)	ATTENUATION (dB)	50 W RETURN LOSS (dB)	75 W RETURN LOSS (dB)
1	5.80	46.06	46.06
3	5.80	46.06	46.06
5	5.80	46.06	46.06
7	5.80	46.06	46.06
10	5.80	46.06	46.06
30	5.82	46.06	46.06
50	5.84	46.06	46.06
70	5.85	46.06	46.06
90	5.86	46.06	46.06
100	5.86	46.06	46.06
200	5.88	46.06	40.09
300	5.88	46.06	36.61
400	5.87	46.06	34.15
500	5.88	40.09	32.26
600	5.88	36.61	32.26
700	5.88	36.61	30.71
800	5.88	34.15	29.42
900	5.87	34.15	28.30
1000	5.87	34.15	27.32
1100	5.83	34.15	26.44
1200	5.81	32.26	25.66
1300	5.79	29.42	24.94
1400	5.76	25.66	24.29
1500	5.82	23.69	23.69
1600	5.84	22.61	23.13
1700	5.80	22.12	23.13
1800	5.79	22.12	22.12
1900	5.79	23.13	21.66
2000	5.79	23.69	20.83
2200	5.62	22.61	19.40
2400	5.51	18.22	18.49
2600	5.64	16.33	17.69
2800	5.80	16.75	16.75
3000	5.81	19.40	15.56

REV. X1
UNMP-5075
061115
Page 1 of 1



IF/RF MICROWAVE COMPONENTS • ISO 9001 ISO 14001 AS 9100 CERTIFIED RoHS compliant

P.O. Box 350166, Brooklyn, New York 11235-0003 (718) 934-4500 Fax (718) 332-4661



The Design Engineers Search Engine finds the model you need, Instantly • For detailed performance specs & shopping online see



Typical Performance Curves

Attenuation

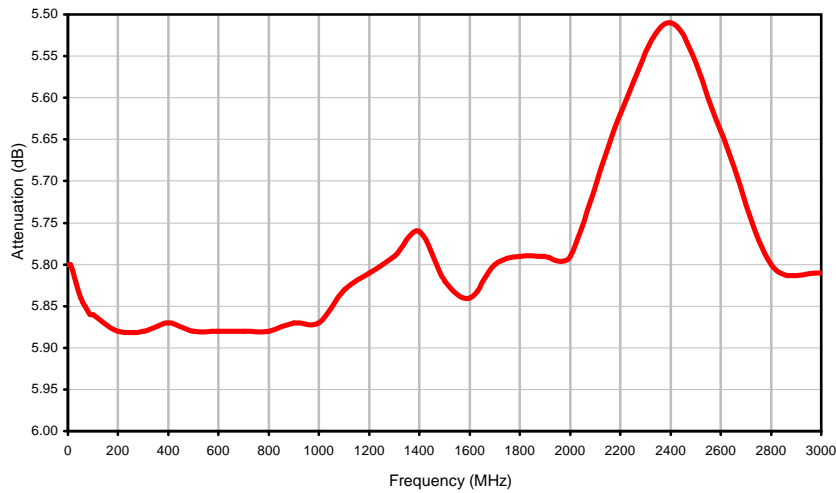

50 Ohm Return Loss

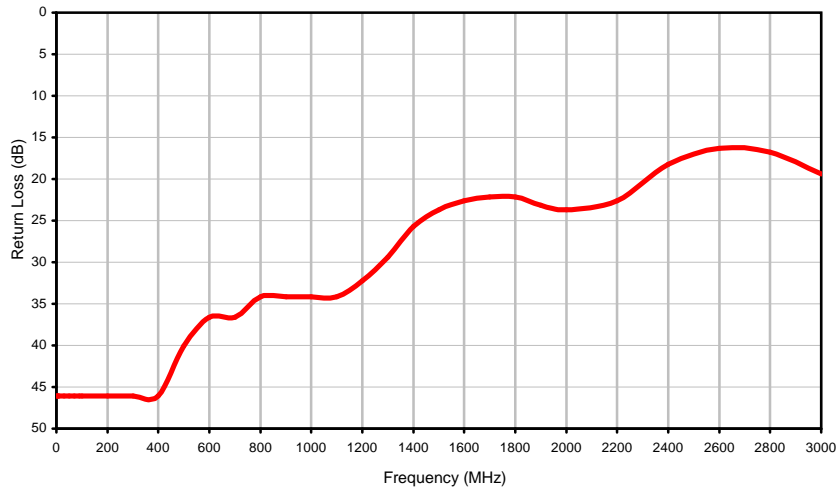

75 Ohm Return Loss

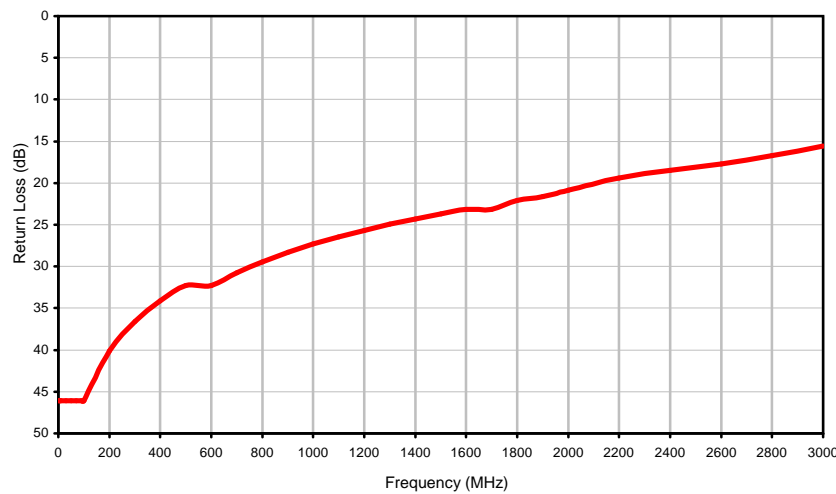

REV. X1
UNMP-5075
061115
Page 1 of 1



IF/RF MICROWAVE COMPONENTS • ISO 9001 ISO 14001 AS 9100 CERTIFIED RoHS compliant
P.O. Box 350166, Brooklyn, New York 11235-0003 (718) 934-4500 Fax (718) 332-4661



The Design Engineers Search Engine finds the model you need, Instantly • For detailed performance specs & shopping online see



Case Style

FF

Outline Dimensions

FF779

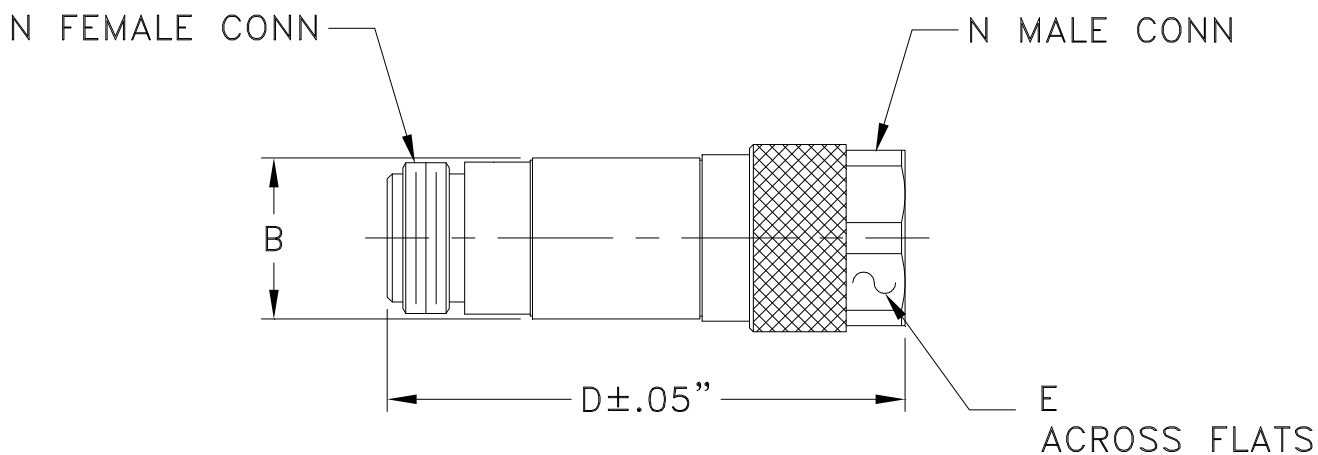

CASE #.	A	B	C	D	E	WT GRAMS
FF779	--	.71 (18.03)	--	2.11 (53.59)	.718 (18.24)	72.5

Dimensions are in inches (mm). Tolerances: 2Pl. +.05/-.04; 3Pl. ± .030

Notes:

1. Case material: Brass.
2. Case finish: Nickel plate.

 **Mini-Circuits**[®]
ISO 9001 ISO 14001 CERTIFIED

ALL NEW

minicircuits.com

P.O. Box 350166, Brooklyn, New York 11235-0003 (718) 934-4500 Fax (718) 332-4661 For detailed performance specs & shopping online see Mini-Circuits web site



The Design Engineers Search Engine Provides ACTUAL Data Instantly From MINI-CIRCUITS At: www.minicircuits.com

RF/IF MICROWAVE COMPONENTS

FF779 Rev.: AR (13/AUG/21) ECO-009237 File: FF779

This document and its contents are the property of Mini-Circuits.

Sheet 1 of 1



All Mini-Circuits products are manufactured under exacting quality assurance and control standards, and are capable of meeting published specifications after being subjected to any or all of the following physical and environmental test.

Specification	Test/Inspection Condition	Reference/Spec
Operating Temperature	-45° to 100° C Ambient Environment	Individual Model Data Sheet
Storage Temperature	-55° to 100° C Ambient Environment	Individual Model Data Sheet
Barometric Pressure	100,000 Feet	MIL-STD-202, Method 105, Condition D
Humidity	90% RH, 65°C Units may require bake-out after humidity to restore full performance.	MIL-STD-202, Method 103
Thermal Shock	-65° to 125°C, 5 cycles	MIL-STD-202, Method 107, Condition B
Vibration (High Frequency)	20g peak, 10-2000 Hz, 12 times in each of three perpendicular directions (total 36)	MIL-STD-202, Method 204, Condition D
Mechanical Shock	100g, 6ms sawtooth, 3 shocks each direction 3 axes (total 18)	MIL-STD-202, Method 213, Condition I