

Solid state

# USB / I<sup>2</sup>C RF SP4T Switch

## U2C-1SP4T-63H

50Ω 2 to 6000 MHz

### The Big Deal

- **USB and I<sup>2</sup>C** power & control
- High speed switch transition, 200 ns
- High power handling (+30 dBm)
- Very High Isolation (80 dB)
- Small case (3.75" x 2.50" x 0.6")



Software Package

Case Style: RB2502

Model No.	Description	Qty.
U2C-1SP4T-63H	Single pole four throw RF Switch	1

#### Included Accessories

MUSB-CBL-3+	2.6 ft USB cable	1
-------------	------------------	---

#### RoHS Compliant

See our web site for RoHS Compliance methodologies and qualifications

### Typical Applications

- High volume production testing / ATE
- Design verification testing
- RF signal routing / switch matrices

### Product Overview

Mini-Circuits' U2C-1SP4T-63H is a low cost, absorptive SP4T switch with USB and I<sup>2</sup>C control. The fast switching, solid state switch operates from 2 MHz to 6000 MHz with 200 ns typical switch transition speed. High linearity (+55 dBm typ IP3), and high isolation (80 dB typical) allow the model to be used for a wide variety of RF applications.

Full software support is provided for USB control, including our user-friendly GUI application for Windows and a full API with programming instructions for USB and I<sup>2</sup>C control in both Windows and Linux environments (32-bit and 64-bit systems). The latest version of the full software package can be downloaded from <https://www.minicircuits.com/softwaredownload/solidstate.html> at any time.

The U2C-1SP4T-63H is housed in a compact, rugged metal case (3.75" x 2.50" x 0.6") with 5 SMA (F) connectors (COM, and J1 to J4), a USB Mini-B and a 9-pin D-sub connector for USB and I<sup>2</sup>C control and power.

### Key Features

Feature	Advantages
Dual control interface (I <sup>2</sup> C & USB)	USB provides a quick and easy PC control method with full software support, while I2C allows multiple switches to be controlled in parallel from a microcontroller / embedded system using minimal hardware (2 wire control)
RF SP4T absorptive switch	Wideband (2 to 6000 MHz) with low insertion loss (3.7 dB typ.), high isolation (80 dB typ.), and high power rating (+30 dBm through path).
High Linearity (IP3 +55 dBm typ.)	Results in little or negligible inter-modulation generation, meeting requirements for digital communications signals
DC Blocking at RF ports	Built in blocking capacitors eliminate the need for external DC blocking circuitry at RF ports.

**Trademarks:** Windows is a registered trademark of Microsoft Corporation in the United States and other countries. Linux is a registered trademark of Linus Torvalds. Pentium is a registered trademark of Intel Corporation. Neither Mini-Circuits nor the Mini-Circuits U2C-1SP4T-63H are affiliated with or endorsed by the owners of the above referenced trademarks

Mini-Circuits and the Mini-Circuits logo are registered trademarks of Scientific Components Corporation.



## Electrical Specifications @ 0 to 50°C

Parameter	Port	Conditions	Min.	Typ.	Max.	Units
Operating Frequency			2		6000	MHz
Insertion Loss	COM to any active port	2 to 700 MHz	-	2.3	3.5	dB
		700 to 2500 MHz	-	3.0	4.5	
		2500 to 5000 MHz	-	3.8	5.5	
		5000 to 6000 MHz	-	4.2	6.0	
Isolation	Between any of ports J1 to J4	2 to 700 MHz	82	105	-	dB
		700 to 2500 MHz	72	90	-	
		2500 to 5000 MHz	53	73	-	
		5000 to 6000 MHz	49	62	-	
	COM to any terminated port	2 to 700 MHz	82	105	-	
		700 to 2500 MHz	77	95	-	
		2500 to 5000 MHz	58	76	-	
		5000 to 6000 MHz	54	64	-	
	Disconnected state (COM port open) <sup>1</sup> : COM to J2, J3, or J4	2 to 700 MHz	82	105	-	
		700 to 2500 MHz	77	95	-	
		2500 to 5000 MHz	58	76	-	
		5000 to 6000 MHz	54	64	-	
	Disconnected state (COM port open) <sup>1</sup> : COM to J1	2 to 700 MHz	42	60	-	
		700 to 2500 MHz	30	44	-	
		2500 to 5000 MHz	25	34	-	
		5000 to 6000 MHz	25	32	-	
VSWR	COM port in all active states <sup>1</sup>	2 to 700 MHz	-	1.40	-	:1
		700 to 2500 MHz	-	1.25	-	
		2500 to 5000 MHz	-	1.25	-	
		5000 to 6000 MHz	-	1.30	-	
	Any port connected to COM	2 to 700 MHz	-	1.40	-	
		700 to 2500 MHz	-	1.25	-	
		2500 to 5000 MHz	-	1.25	-	
		5000 to 6000 MHz	-	1.30	-	
	Any terminated port	2 to 700 MHz	-	1.15	-	
		700 to 2500 MHz	-	1.15	-	
		2500 to 5000 MHz	-	1.20	-	
		5000 to 6000 MHz	-	1.35	-	
Power Input @ 1 dB Compression <sup>2,3,4</sup>	COM to any active port	100 to 6000 MHz	-	+35	-	dBm
IP <sub>3</sub> <sup>2,4,5</sup>	COM to any active port	100 to 6000 MHz	-	+55	-	dBm
Transition Time <sup>6</sup>	-	-	-	200	300	ns
Minimum dwell time <sup>7</sup>	High Speed Mode	-	-	5	-	µs
Switching Time (USB) <sup>8</sup>	-	-	-	2	-	ms
Supply voltage (V <sub>cc</sub> )	USB or D-Sub port	-	4.75	5	5.25	V <sub>DC</sub>
Supply Current (I <sub>cc</sub> )		-	-	30	50	mA
Operating RF Input Power <sup>3</sup>	COM to any active port	Hot & Cold Switching	-	-	+30	dBm
	Any active port to COM	Hot & Cold Switching	-	-	+23	
	Any terminated port	-	-	-	+23	
	Through path	2 to 50 MHz	Max power at through path derates linearly from +30 dBm @ 50 MHz to +18 dBm @ 2 MHz			
50 to 6000 MHz		-	-	+30		

<sup>1</sup> When switch is at DISCONNECT state (see page 9) COM port will be in OPEN (reflective) state and all output ports (J1-J4) will be absorptive, however J1 port isolation is affected under this configuration, while J2, J3, J4 still maintain the same isolation as in the normal operating conditions.

<sup>2</sup> Do not exceed absolute maximum ratings in table on page 3

<sup>3</sup> Max power at through path derates linearly from +30 dBm @ 50 MHz to +18 dBm @ 2 MHz

<sup>4</sup> Compression and IP<sub>3</sub> may degrade below 100 MHz

<sup>5</sup> IP<sub>3</sub> tested with 1 MHz span between signals, +5 dBm per tone.

<sup>6</sup> Transition time spec represents the time that the RF signal paths are interrupted during switching and thus is specified without communication delays.

<sup>7</sup> Minimum dwell time is the shortest time that can be achieved between 2 switch transitions when programming an automated switch sequence.

<sup>8</sup> Switching time(USB) is the time from issuing a single software command via USB to the switch state changing. The most significant factor is the host PC, influenced by CPU load and USB protocol. The time shown is an estimate for a medium CPU load and USB 2.0 connection.

## Control voltages for I<sup>2</sup>C Control

Parameter		Min.	Typ.	Max.	Units
Control Input	Low	0	—	0.8	V
	High	2.0	—	3.3	

## Connections

RF Switch (J1 to J4, COM)	(SMA female)
USB	(USB type Mini-B receptacle)
I <sup>2</sup> C*	(9 pin D-sub female)

## Absolute Maximum Ratings

Operating Temperature	0°C to 50°C
Storage Temperature	-20°C to 60°C
DC supply voltage max. @ USB and pin 4 of D-sub	6V
Voltage on I <sup>2</sup> C control pins (1 & 2 in D-sub)	3.6V
Voltage on address pins (6 - 8 in D-sub)	3.6V
RF power @ 2 - 6000 MHz into termination	+24 dBm
RF power @ 2 - 50 MHz into COM or active port	Derate linearly from +35 dBm @ 50 MHz to +20 dBm @ 2 MHz
RF power @ 50 - 6000 MHz into COM or active port	+35 dBm
DC voltage @ RF Ports	16V

Permanent damage may occur if any of these limits are exceeded. Operating in the range between operating power limits and absolute maximum ratings for extended periods of time may result in reduced life and reliability.

## \*9 Pin D-Sub Pin Connections

PIN Number	Function
1	SDA
2	SCL
3	GND
4	Vcc
5	GND
6	A0
7	A1
8	A2
9	GND

## Block Diagram

**Note:** Power supply is needed from only one port at a time. Power can be supplied via USB or I<sup>2</sup>C port regardless of the control interface used

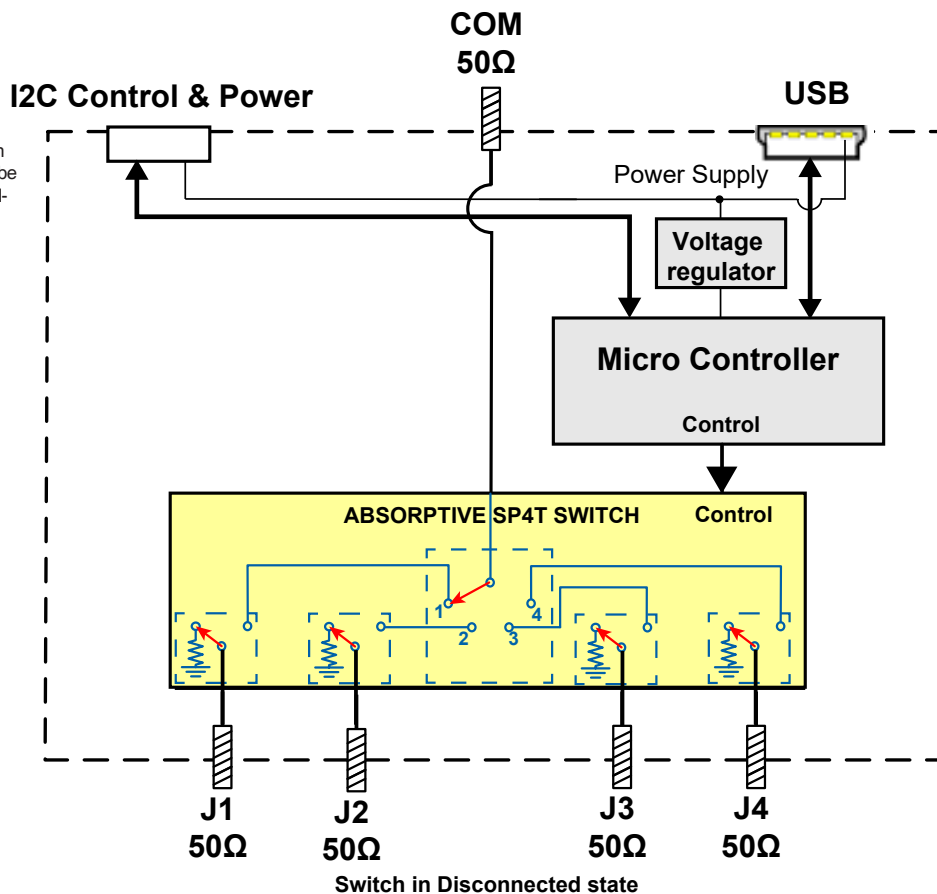

## I<sup>2</sup>C communication parameters

Parameter	Conditions		Min.	Typ.	Max.	Units
Voltage levels	Logic Low Voltage	Input	0	-	0.8	V
	Logic High Voltage	Input	2.0	-	3.3	
Clock Frequency	-		-	-	400	kHz

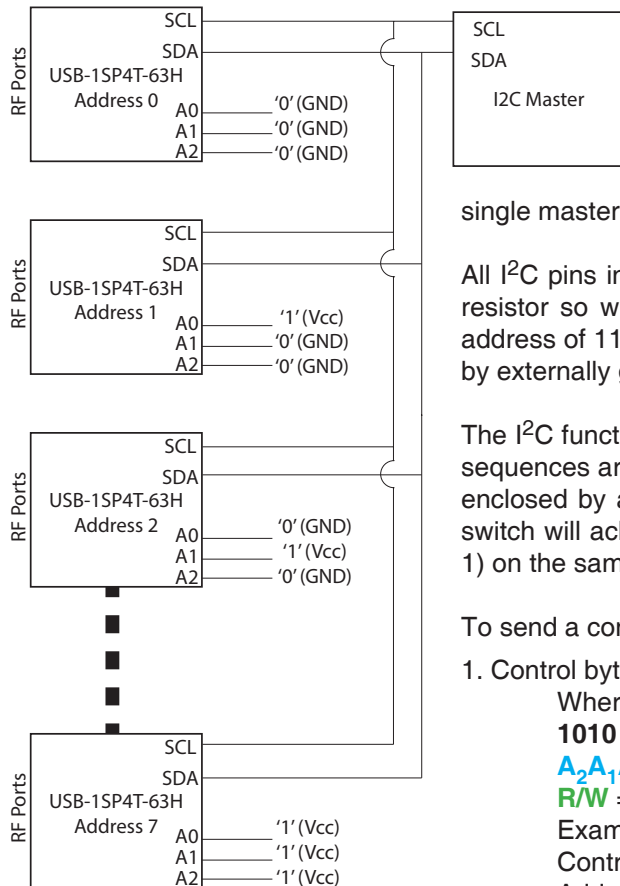

The I<sup>2</sup>C is a short-range synchronous communication protocol for simple 2-wire communication with slave devices using clock (SCL) and data (SDA) connections. The U2C-1SP4T-63VH interface also includes 3 address pins (A0, A1 and A2), allowing up to 8 switches to be controlled independently from a single master with shared SDA and SCL connections.

All I<sup>2</sup>C pins in the U2C-1SP4T-63VH are connected to an internal pullup resistor so will float to logic 1 when disconnected. This sets a default address of 111 for all units (decimal 7). Addresses from 0 to 7 can be set by externally grounding the relevant address pins (A0, A1 and A2).

The I<sup>2</sup>C functionality is limited to setting or reading switch states. Control sequences are sent to the switch in several bytes on the data connection, enclosed by a start and stop signal, and clocked at up to 400 kHz. The switch will acknowledge each byte received with a single "ACK" bit (logic 1) on the same data connection.

To send a command to the switch 3 bytes will be sent:

1. Control byte (1010A<sub>2</sub>A<sub>1</sub>A<sub>0</sub>R/W)

Where:

**1010** = Control code for U2C-1SP4T-63VH

**A<sub>2</sub>A<sub>1</sub>A<sub>0</sub>** = 3-bit address for the U2C-1SP4T-63VH switch module

**R/W** = Read / write select bit ('0' to write or '1' to read)

Example:

Control byte = **10101000**

Address = **100** (binary) = 4 (decimal)

R/W = **0** (write to switch)

2. Switch selector byte (00000001) - U2C-1SP4T-63VH contains only 1 switch so this byte is always 00000001.
3. Switch state byte (00000XYZ) - The switch state, represented by a binary string according to the truth table below.

Switch state	Switch state byte	Port behavior				
		COM	J1	J2	J3	J4
Disconnected	0000 0000	Reflective	Terminated Internally (50Ω)	Terminated Internally (50Ω)	Terminated Internally (50Ω)	Terminated Internally (50Ω)
COM -> 1	0000 0001	Connected to J1	Connected to COM	Terminated Internally (50Ω)	Terminated Internally (50Ω)	Terminated Internally (50Ω)
COM -> 2	0000 0010	Connected to J2	Terminated Internally (50Ω)	Connected to COM	Terminated Internally (50Ω)	Terminated Internally (50Ω)
COM -> 3	0000 0011	Connected to J3	Terminated Internally (50Ω)	Terminated Internally (50Ω)	Connected to COM	Terminated Internally (50Ω)
COM -> 4	0000 0100	Connected to J4	Terminated Internally (50Ω)	Terminated Internally (50Ω)	Terminated Internally (50Ω)	Connected to COM

In I<sup>2</sup>C protocol the Data line may not change states while the Clock is high, except for the start and stop signals which enclose each sequence of bytes. While the Clock is high a falling edge (transition from logic 1 to logic 0) signifies the start of a sequence, while a rising edge (transition from logic 0 to logic 1) signifies a stop signal. All other transitions must occur while the clock is low.

## Setting switch state via I<sup>2</sup>C

The I<sup>2</sup>C communication sequence to set the switch state is:

1. Start signal
2. Send control byte (write mode)
3. Receive ACK response from switch
4. Send switch selector byte
5. Receive ACK response from switch
6. Send switch state byte
7. Receive ACK response from switch
8. Stop signal

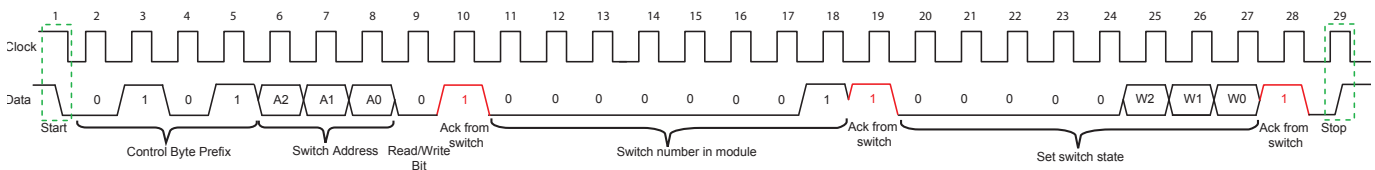

### Legend:

Signal from master to switch —————  
 Signal from switch to master —————

## Reading switch state via I<sup>2</sup>C

The I<sup>2</sup>C communication sequence to set the switch state is:

- |                                     |                                     |
|-------------------------------------|-------------------------------------|
| 1. Start signal                     | 7. Start signal                     |
| 2. Send control byte (write mode)   | 8. Send control byte (read mode)    |
| 3. Receive ACK response from switch | 9. Receive ACK response from switch |
| 4. Send switch selector byte        | 10. Receive current switch state    |
| 5. Receive ACK response from switch | 11. Stop signal                     |
| 6. Stop signal                      |                                     |

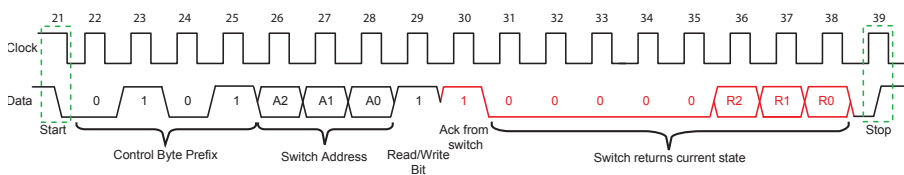
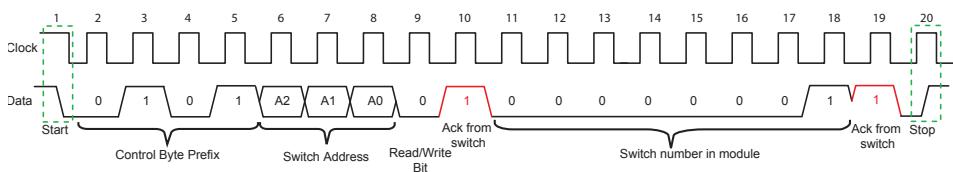

### Legend:

Signal from master to switch —————  
 Signal from switch to master —————

## Outline Drawing (RB2502)

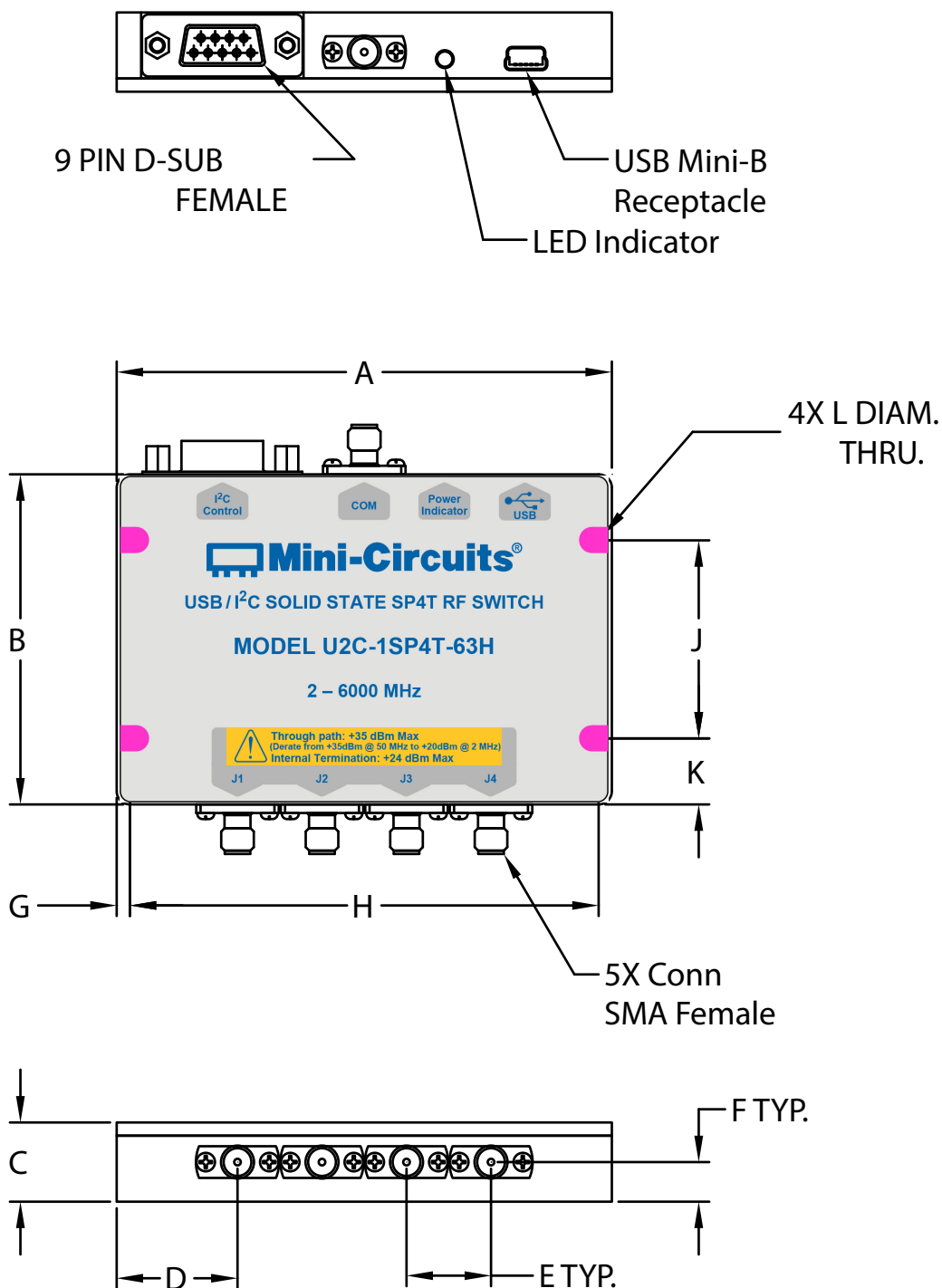

### Outline Dimensions ( $\frac{\text{inch}}{\text{mm}}$ )

A	B	C	D	E	F	G	H	J	K	L	WT. GRAMS
3.75	2.50	0.60	0.915	0.640	0.300	0.10	3.55	1.50	0.50	0.106	220
95.25	63.50	15.24	23.24	16.26	7.62	2.54	90.17	38.10	12.70	2.69	

## Typical Performance Curves

### Insertion Loss J1 Active (over Temp.)

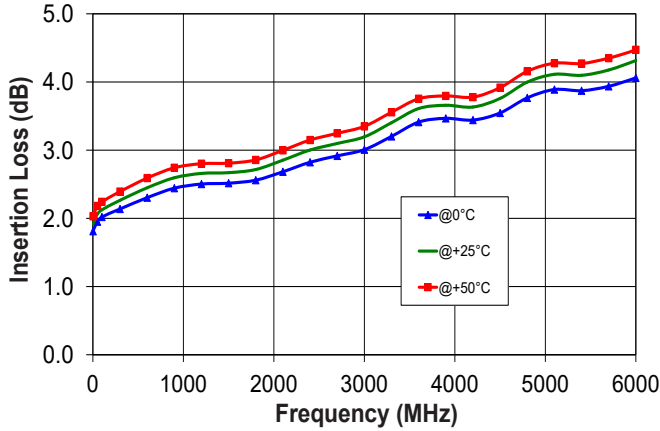

### Insertion Loss J1/2/3/4 Active

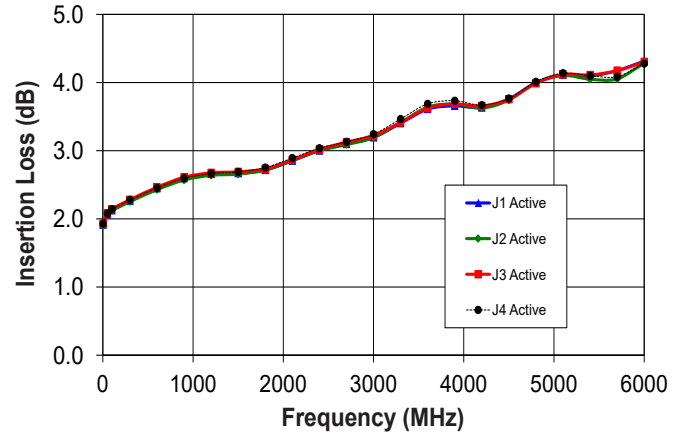

### Isolation COM to J1 (J2 Active)

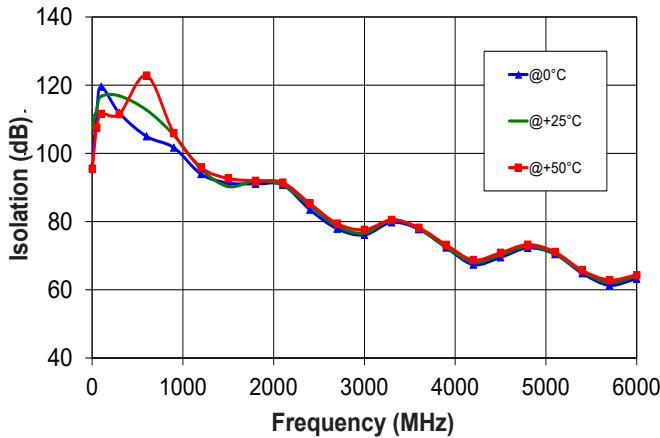

### Isolation COM to J1 (J3 Active)

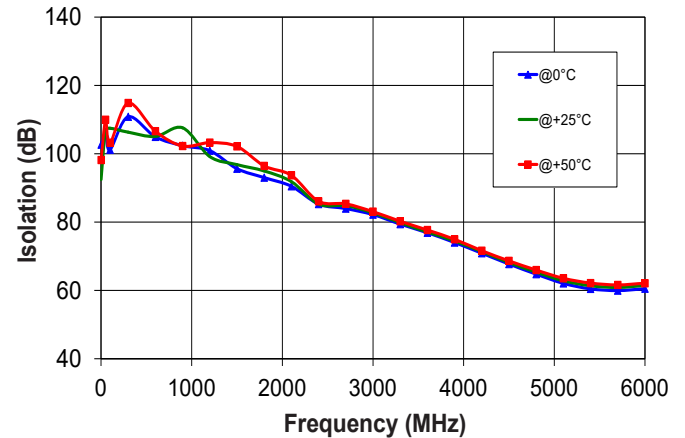

### Isolation J2 to J3 (J3 Active)

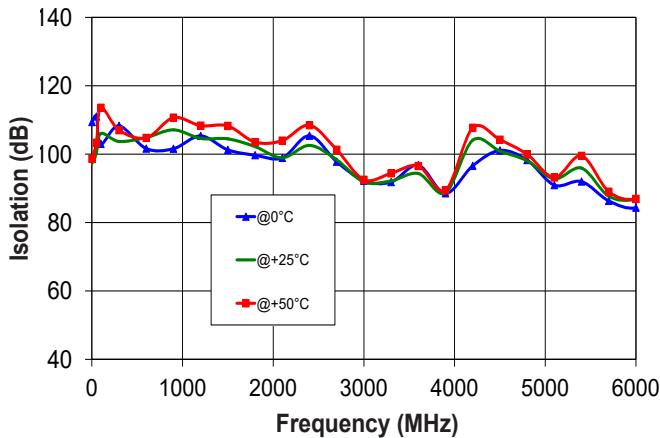

### Isolation J1 to J3 (J2 Active)

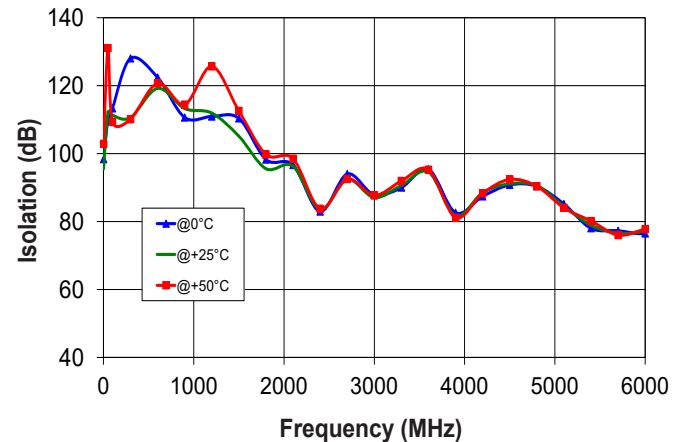

## Typical Performance Curves (Continued)

**VSWR @ COM over Temp. (J1 Active)**

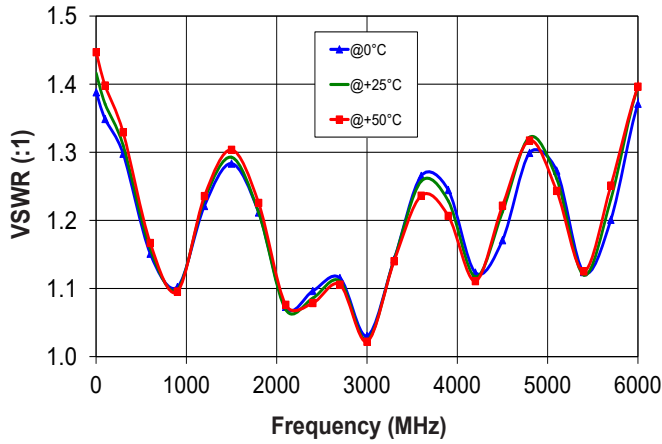

**VSWR @ COM (J1/2/3/4 Active)**

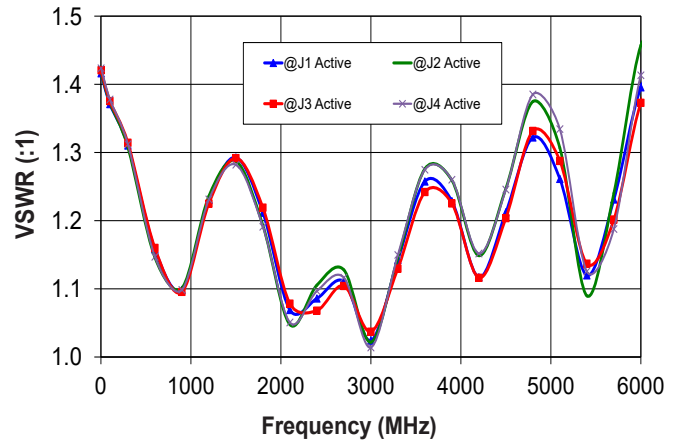

**VSWR @ J1 Active Port over Temp.**

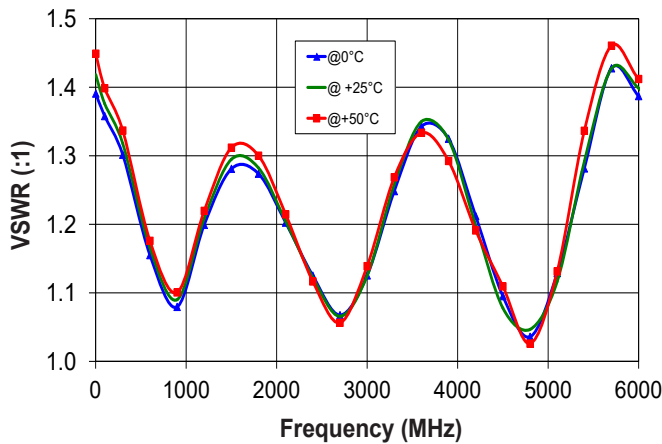

**VSWR @ Active Ports J1/2/3/4**

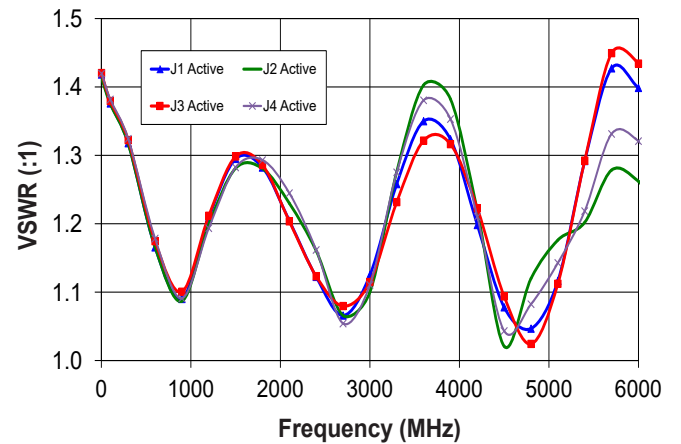

**VSWR @ J1 Terminated over Temp.**

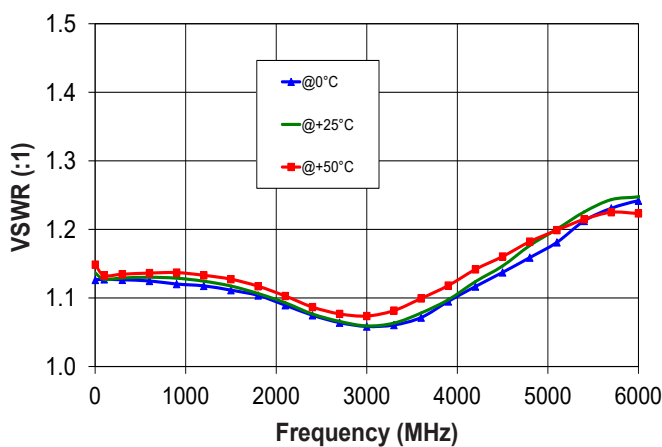

**VSWR J1/2/3/4 Terminated Ports**

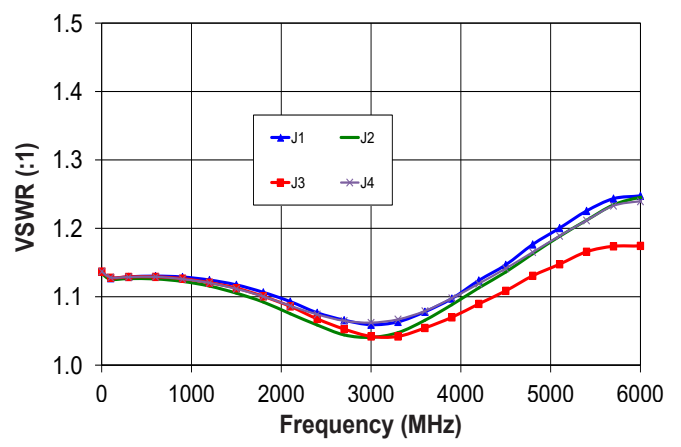



## Software & Documentation Download:

- Mini-Circuits' full software and support package including user guide, Windows GUI, DLL files, programming manual and examples can be downloaded free of charge from <https://www.minicircuits.com/softwaredownload/solidstate.html>
- Please contact [testsolutions@minicircuits.com](mailto:testsolutions@minicircuits.com) for support

## Minimum System Requirements

Parameter	Requirements	
Interface	USB HID or I <sup>2</sup> C	
System requirements	GUI:	Windows 32 & 64 bit systems from Windows 98 up to Windows 10
	USB API (ActiveX & .Net)	Windows 32 & 64 bit systems with ActiveX or .Net support from Windows 98 up to Windows 10
	I <sup>2</sup> C	Any computer with a suitable I/O port
	USB direct programming support	Linux, Windows systems from Windows 98 up to Windows 10
Hardware	Pentium® II or higher, RAM 256 MB	

## Graphical User Interface (GUI) for Windows

### Key Features:

- Set switch manually
- Set timed sequence of switching states
- Configure switch address and upgrade Firmware

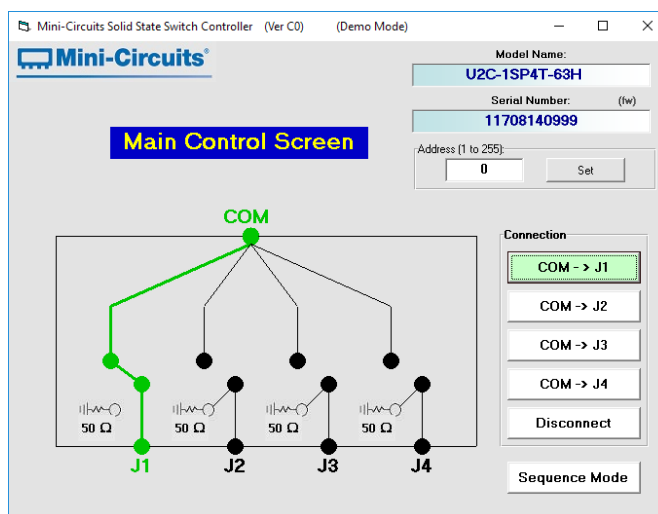

## Application Programming Interface (API)

### Windows Support:

- API DLL files exposing the full switch functionality
  - ActiveX COM DLL file for creation of 32-bit programs
  - .Net library DLL file for creation of 32 / 64-bit programs
- Supported by most common programming environments (refer to application note [AN-49-001](#) for summary of tested environments)

### Linux Support:

- Full switch control in a Linux environment is achieved by way of USB interrupt commands.

## Recommended Accessories

U2C-1SP4T-63H includes a standard 9 pin D-Sub connector for I<sup>2</sup>C control applications. An optional shielded control cable is available for implementing custom cable harnesses. D-SUB9-MPT-3+ has a D-Sub connector for mating to U2C-1SP4T-63H and bare wires (pig tail) on the other end. The cable is 36 inches (0.9 meter) long using 28 AWG wires

**Control Cable D-SUB9-MPT-3+**

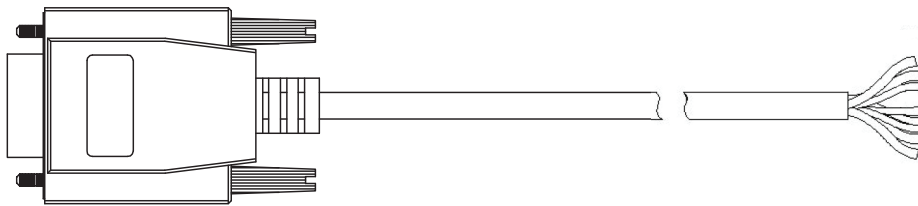

Pin Number	Function	Description	Pigtail Wire Color
1	SDA	I <sup>2</sup> C Data	BLACK
2	SCL	I <sup>2</sup> C Clock	BROWN
3	GND	Ground connection	RED
4	VCC	Supply Voltage	ORANGE
5	GND	Ground connection	YELLOW
6	A0	Address bit 0 (LSB)	GREEN
7	A1	Address bit 1	BLUE
8	A2	Address bit 2 (MSB)	PURPLE
9	GND	Ground connection	WHITE

Ordering, Pricing & Availability Information see our web site

Model	Description
U2C-1SP4T-63H	USB & I <sup>2</sup> C Single Pole Four Throw Switch

Included Accessories	Part No.	Description
	MUSB-CBL-3+	2.6 ft (0.8 m) USB Cable: USB type A(Male) to USB type Mini-B(Male)

Optional Accessories	Description
MUSB-CBL-3+ (Spare)	2.6 ft (0.8 m) USB Cable: USB type A(Male) to USB type Mini-B(Male)
MUSB-CBL-7+	6.6 ft (2.0 m) USB Cable: USB type A(Male) to USB type Mini-B(Male)
D-SUB9-MPT-3+	3 ft I2C Cable: 9 pin D-sub(Male) to Pig-Tail (Bare wires)
USB-AC/DC-5+	AC/DC +5V power adaptor with USB connector <sup>9,10</sup>

<sup>9</sup> The USB-AC/DC-5 may be used to provide additional power if needing to connect a number of switches in series exceeding 500mA total current draw.

<sup>10</sup> Includes power plugs for US, UK, EU, IL, AU & China. Plugs for other countries are also available, if you need a power plug for a country not listed please contact [testsolutions@minicircuits.com](mailto:testsolutions@minicircuits.com)

### Additional Notes

- A. Performance and quality attributes and conditions not expressly stated in this specification document are intended to be excluded and do not form a part of this specification document.
- B. Electrical specifications and performance data contained in this specification document are based on Mini-Circuit's applicable established test performance criteria and measurement instructions.
- C. The parts covered by this specification document are subject to Mini-Circuits standard limited warranty and terms and conditions (collectively, "Standard Terms"); Purchasers of this part are entitled to the rights and benefits contained therein. For a full statement of the Standard Terms and the exclusive rights and remedies thereunder, please visit Mini-Circuits' website at [www.minicircuits.com/MCLStore/terms.jsp](http://www.minicircuits.com/MCLStore/terms.jsp)

# Solid State USB / I<sup>2</sup>C RF SP4T Switch

## U2C-1SP4T-63H

### Typical Performance Data

TEST CONDITIONS: @Temperature = 0°C, Pin=8dBm

FREQUENCY (MHz)	INSERTION LOSS			
	(dB)			
	COM-J1	COM-J2	COM-J3	COM-J4
0.1	2.09	2.08	2.10	2.11
0.5	1.72	1.72	1.75	1.75
1.0	1.74	1.74	1.77	1.77
2.0	1.81	1.80	1.84	1.84
4.0	1.86	1.86	1.89	1.89
10.0	1.90	1.89	1.92	1.93
50.0	1.95	1.95	1.98	1.98
100.0	2.02	2.02	2.05	2.05
200.0	2.09	2.09	2.12	2.13
300.0	2.14	2.13	2.17	2.17
400.0	2.19	2.18	2.22	2.22
500.0	2.25	2.24	2.28	2.28
600.0	2.30	2.29	2.33	2.33
800.0	2.40	2.39	2.43	2.43
1000.0	2.47	2.46	2.50	2.50
1200.0	2.50	2.50	2.54	2.54
1400.0	2.51	2.51	2.55	2.56
1600.0	2.52	2.53	2.56	2.58
1800.0	2.56	2.57	2.60	2.63
2000.0	2.63	2.66	2.67	2.71
2200.0	2.73	2.75	2.77	2.80
2400.0	2.82	2.84	2.86	2.89
2600.0	2.89	2.91	2.94	2.96
2800.0	2.94	2.95	2.99	3.02
3000.0	3.01	3.02	3.06	3.09
3200.0	3.13	3.15	3.17	3.22
3400.0	3.28	3.32	3.32	3.39
3600.0	3.41	3.47	3.45	3.54
3800.0	3.47	3.53	3.52	3.59
4000.0	3.45	3.50	3.51	3.57
4200.0	3.44	3.46	3.49	3.53
4400.0	3.49	3.50	3.53	3.55
4600.0	3.62	3.63	3.64	3.68
4800.0	3.77	3.79	3.79	3.84
5000.0	3.87	3.90	3.91	3.95
5200.0	3.89	3.91	3.94	3.98
5400.0	3.87	3.87	3.92	3.95
5600.0	3.90	3.83	3.94	3.91
5800.0	3.98	3.90	4.01	3.96
5900.0	4.02	3.98	4.05	4.03
6000.0	4.06	4.04	4.10	4.10
6200.0	4.15	4.13	4.20	4.21
6400.0	4.26	4.19	4.31	4.29
6600.0	4.40	4.25	4.44	4.37
6800.0	4.53	4.36	4.57	4.48
7000.0	4.67	4.50	4.71	4.60
7200.0	4.73	4.61	4.77	4.68
7400.0	4.73	4.72	4.77	4.78
7600.0	4.84	4.77	4.86	4.85
7800.0	5.01	4.88	5.01	4.99
8000.0	5.14	5.06	5.13	5.17

**Notes**

- A. Performance and quality attributes and conditions not expressly stated in this specification document are intended to be excluded and do not form a part of this specification document.
- B. Electrical specifications and performance data contained in this specification document are based on Mini-Circuits' applicable established test performance criteria and measurement instructions.
- C. The parts covered by this specification document are subject to Mini-Circuits standard limited warranty and terms and conditions (collectively, "Standard Terms"); Purchasers of this part are entitled to the rights and benefits contained therein. For a full statement of the Standard Terms and the exclusive rights and remedies thereunder, please visit Mini-Circuits' website at [www.minicircuits.com/MCLStore/terms.jsp](http://www.minicircuits.com/MCLStore/terms.jsp)



# Solid State USB / I<sup>2</sup>C RF SP4T Switch

## U2C-1SP4T-63H

### Typical Performance Data

TEST CONDITIONS: @Temperature = 0°C, Pin=8dBm

FREQUENCY (MHz)	VSWR, Active Ports					VSWR, Internally Terminated Ports			
	COM	J1	(:1)			(:1)			
			J2	J3	J4	J1	J2	J3	J4
0.1	1.96	1.96	1.96	1.96	1.96	1.43	1.42	1.42	1.43
0.5	1.44	1.45	1.44	1.45	1.45	1.15	1.15	1.15	1.16
1.0	1.41	1.42	1.41	1.42	1.42	1.14	1.13	1.13	1.14
2.0	1.39	1.39	1.39	1.39	1.39	1.13	1.12	1.13	1.13
4.0	1.37	1.37	1.37	1.38	1.38	1.12	1.12	1.12	1.12
10.0	1.36	1.36	1.36	1.37	1.37	1.12	1.12	1.12	1.12
50.0	1.35	1.36	1.36	1.36	1.37	1.12	1.12	1.12	1.12
100.0	1.35	1.36	1.35	1.36	1.36	1.13	1.12	1.13	1.13
200.0	1.33	1.34	1.33	1.34	1.34	1.13	1.13	1.13	1.13
300.0	1.30	1.30	1.30	1.31	1.31	1.13	1.12	1.12	1.12
400.0	1.24	1.26	1.26	1.26	1.27	1.12	1.12	1.12	1.12
500.0	1.20	1.21	1.21	1.21	1.22	1.12	1.12	1.12	1.12
600.0	1.15	1.16	1.15	1.16	1.17	1.12	1.12	1.12	1.12
800.0	1.09	1.07	1.08	1.09	1.09	1.12	1.12	1.12	1.12
1000.0	1.13	1.12	1.12	1.12	1.11	1.12	1.12	1.12	1.12
1200.0	1.22	1.20	1.20	1.20	1.19	1.12	1.12	1.12	1.12
1400.0	1.28	1.27	1.25	1.27	1.25	1.11	1.10	1.11	1.11
1600.0	1.28	1.29	1.27	1.29	1.28	1.11	1.10	1.10	1.10
1800.0	1.21	1.27	1.26	1.27	1.28	1.10	1.08	1.10	1.09
2000.0	1.12	1.23	1.24	1.23	1.26	1.09	1.08	1.09	1.09
2200.0	1.05	1.17	1.21	1.17	1.22	1.08	1.07	1.08	1.08
2400.0	1.10	1.13	1.17	1.13	1.16	1.07	1.05	1.06	1.07
2600.0	1.12	1.08	1.11	1.10	1.10	1.07	1.04	1.05	1.06
2800.0	1.09	1.07	1.04	1.08	1.04	1.06	1.03	1.04	1.06
3000.0	1.03	1.13	1.09	1.11	1.11	1.06	1.03	1.04	1.06
3200.0	1.09	1.21	1.21	1.18	1.22	1.06	1.04	1.03	1.06
3400.0	1.19	1.29	1.32	1.26	1.32	1.06	1.05	1.04	1.07
3600.0	1.27	1.34	1.40	1.31	1.38	1.07	1.06	1.04	1.08
3800.0	1.27	1.35	1.41	1.34	1.38	1.09	1.07	1.06	1.09
4000.0	1.21	1.29	1.35	1.29	1.31	1.10	1.09	1.07	1.10
4200.0	1.12	1.21	1.24	1.24	1.22	1.12	1.10	1.07	1.11
4400.0	1.13	1.13	1.10	1.15	1.11	1.13	1.11	1.09	1.12
4600.0	1.23	1.06	1.02	1.07	1.02	1.15	1.12	1.09	1.13
4800.0	1.30	1.04	1.12	1.02	1.07	1.16	1.15	1.10	1.15
5000.0	1.30	1.08	1.18	1.08	1.13	1.18	1.16	1.12	1.16
5200.0	1.23	1.18	1.21	1.18	1.19	1.19	1.17	1.12	1.17
5400.0	1.12	1.28	1.22	1.29	1.25	1.21	1.19	1.13	1.18
5600.0	1.15	1.39	1.23	1.38	1.30	1.23	1.22	1.15	1.20
5800.0	1.27	1.43	1.25	1.44	1.31	1.23	1.23	1.17	1.21
5900.0	1.34	1.42	1.26	1.44	1.32	1.24	1.23	1.17	1.22
6000.0	1.37	1.39	1.23	1.41	1.30	1.24	1.24	1.16	1.22
6200.0	1.42	1.34	1.17	1.32	1.23	1.25	1.25	1.15	1.22
6400.0	1.47	1.40	1.20	1.37	1.26	1.24	1.25	1.18	1.23
6600.0	1.55	1.60	1.37	1.55	1.43	1.25	1.25	1.20	1.23
6800.0	1.63	1.78	1.57	1.75	1.63	1.23	1.25	1.20	1.23
7000.0	1.64	1.83	1.68	1.82	1.73	1.24	1.24	1.22	1.23
7200.0	1.53	1.69	1.62	1.71	1.66	1.24	1.23	1.24	1.22
7400.0	1.44	1.49	1.46	1.52	1.51	1.24	1.22	1.26	1.23
7600.0	1.54	1.45	1.37	1.44	1.42	1.24	1.21	1.31	1.24
7800.0	1.75	1.62	1.50	1.59	1.55	1.27	1.22	1.38	1.27
8000.0	1.87	1.77	1.70	1.75	1.75	1.31	1.25	1.45	1.32

**Notes**

- A. Performance and quality attributes and conditions not expressly stated in this specification document are intended to be excluded and do not form a part of this specification document.
- B. Electrical specifications and performance data contained in this specification document are based on Mini-Circuits' applicable established test performance criteria and measurement instructions.
- C. The parts covered by this specification document are subject to Mini-Circuits standard limited warranty and terms and conditions (collectively, "Standard Terms"); Purchasers of this part are entitled to the rights and benefits contained therein. For a full statement of the Standard Terms and the exclusive rights and remedies thereunder, please visit Mini-Circuits' website at [www.minicircuits.com/MCLStore/terms.jsp](http://www.minicircuits.com/MCLStore/terms.jsp)



# Solid State USB / I<sup>2</sup>C RF SP4T Switch

## U2C-1SP4T-63H

### Typical Performance Data

TEST CONDITIONS: @Temperature = 0°C, Pin=8dBm

FREQUENCY (MHz)	ISOLATION						
	(dB)						
	COM-J1 @J3 Active	COM-J1 @J2 Active	J2-J3 @J3 Active	J2-J3 @J1 Active	J1-J2 @J1 Active	COM-J1 @ Disconnect	COM-J4 @ Disconnect
0.1	108.64	100.53	94.35	97.84	103.69	94.24	103.44
0.5	93.12	98.31	98.97	101.16	96.08	85.03	92.96
1.0	99.46	96.91	97.18	90.28	93.40	81.03	101.16
2.0	96.38	102.67	109.40	97.15	98.39	76.55	94.15
4.0	95.29	99.51	102.46	91.77	96.17	74.96	91.53
10.0	107.91	107.16	105.80	104.73	112.06	73.39	115.91
50.0	112.04	105.78	111.04	106.73	109.71	68.50	112.83
100.0	119.56	101.17	103.00	105.03	113.32	64.07	112.68
200.0	116.06	107.83	102.39	102.83	114.16	59.21	124.91
300.0	111.84	110.83	108.30	104.40	128.04	56.24	124.87
400.0	114.64	108.40	103.43	111.03	113.07	53.98	111.67
500.0	107.39	105.99	103.05	105.78	107.68	52.14	107.91
600.0	105.01	104.94	101.64	104.92	122.41	50.62	114.82
800.0	103.50	107.67	105.36	107.19	117.21	48.24	120.74
1000.0	101.72	99.04	106.18	105.19	108.85	46.60	115.65
1200.0	93.95	100.91	105.36	107.76	110.92	45.41	121.15
1400.0	89.93	97.71	102.07	104.42	119.50	44.38	120.77
1600.0	90.77	95.22	99.77	100.83	120.96	43.31	115.07
1800.0	91.06	93.01	99.71	92.03	98.26	42.09	111.33
2000.0	90.55	92.37	102.46	101.97	101.11	40.78	123.79
2200.0	89.17	89.18	101.40	97.94	93.14	39.57	109.93
2400.0	83.50	85.27	105.40	97.14	82.95	38.76	110.85
2600.0	80.83	84.94	102.43	99.89	89.24	38.38	109.67
2800.0	76.58	83.17	93.37	93.37	91.47	38.16	110.70
3000.0	76.11	82.19	92.23	85.99	87.83	37.75	113.51
3200.0	78.85	80.58	86.44	78.32	83.30	37.03	107.44
3400.0	79.45	78.37	93.97	87.32	95.97	36.08	121.03
3600.0	77.78	76.87	96.78	86.60	95.41	35.25	132.17
3800.0	74.47	74.91	93.43	80.72	87.57	34.91	117.25
4000.0	70.14	73.19	89.11	72.14	79.24	35.02	110.30
4200.0	67.40	70.88	96.60	80.48	87.41	35.16	127.00
4400.0	68.30	68.83	98.69	85.47	91.57	35.04	113.09
4600.0	70.75	66.67	97.48	88.31	90.74	34.57	111.96
4800.0	72.28	64.75	98.29	88.97	90.40	33.97	107.18
5000.0	71.38	62.91	92.77	89.22	88.37	33.59	98.48
5200.0	68.63	61.29	89.84	88.28	81.56	33.54	111.61
5400.0	64.85	60.44	92.00	88.02	78.04	33.57	105.04
5600.0	61.78	59.98	89.75	84.61	79.14	33.41	113.24
5800.0	61.68	60.04	84.31	74.99	73.85	32.96	95.49
5900.0	62.50	60.24	84.34	73.63	74.22	32.66	93.39
6000.0	63.22	60.51	84.37	74.95	76.51	32.33	93.45
6200.0	64.13	61.08	87.47	74.15	78.06	31.82	93.51
6400.0	63.83	61.50	92.76	74.83	80.14	31.61	90.49
6600.0	62.38	61.74	93.81	72.03	78.18	31.59	94.03
6800.0	60.31	61.72	89.79	67.31	74.49	31.42	94.02
7000.0	57.47	61.60	91.58	68.76	76.42	30.95	93.07
7200.0	55.92	61.25	91.22	74.63	82.77	30.21	91.55
7400.0	57.10	60.70	87.32	76.56	83.45	29.58	84.04
7600.0	57.90	60.16	86.84	76.86	82.60	29.35	85.61
7800.0	57.90	59.40	87.14	76.28	80.59	29.42	83.44
8000.0	57.11	58.65	90.64	74.35	76.34	29.39	84.13

**Notes**

- A. Performance and quality attributes and conditions not expressly stated in this specification document are intended to be excluded and do not form a part of this specification document.
- B. Electrical specifications and performance data contained in this specification document are based on Mini-Circuits' applicable established test performance criteria and measurement instructions.
- C. The parts covered by this specification document are subject to Mini-Circuits standard limited warranty and terms and conditions (collectively, "Standard Terms"); Purchasers of this part are entitled to the rights and benefits contained therein. For a full statement of the Standard Terms and the exclusive rights and remedies thereunder, please visit Mini-Circuits' website at [www.minicircuits.com/MCLStore/terms.jsp](http://www.minicircuits.com/MCLStore/terms.jsp)



# Solid State USB / I<sup>2</sup>C RF SP4T Switch

## U2C-1SP4T-63H

### Typical Performance Data

TEST CONDITIONS: @Temperature = +25°C, Pin=8dBm

FREQUENCY (MHz)	INSERTION LOSS			
	(dB)			
	COM-J1	COM-J2	COM-J3	COM-J4
0.1	2.17	2.15	2.18	2.18
0.5	1.82	1.81	1.84	1.83
1.0	1.84	1.83	1.86	1.86
2.0	1.92	1.90	1.93	1.93
4.0	1.97	1.96	1.99	1.99
10.0	2.01	2.00	2.02	2.02
50.0	2.06	2.05	2.08	2.08
100.0	2.13	2.12	2.14	2.14
200.0	2.20	2.19	2.22	2.22
300.0	2.27	2.25	2.28	2.28
400.0	2.33	2.31	2.34	2.34
500.0	2.39	2.37	2.40	2.40
600.0	2.45	2.43	2.46	2.45
800.0	2.56	2.53	2.57	2.56
1000.0	2.63	2.60	2.64	2.63
1200.0	2.66	2.64	2.68	2.67
1400.0	2.67	2.65	2.69	2.68
1600.0	2.68	2.67	2.70	2.70
1800.0	2.72	2.72	2.73	2.75
2000.0	2.80	2.80	2.81	2.84
2200.0	2.91	2.91	2.92	2.94
2400.0	3.00	3.00	3.02	3.04
2600.0	3.07	3.07	3.10	3.10
2800.0	3.12	3.12	3.15	3.16
3000.0	3.20	3.19	3.22	3.24
3200.0	3.32	3.33	3.34	3.38
3400.0	3.48	3.50	3.49	3.55
3600.0	3.61	3.64	3.62	3.69
3800.0	3.66	3.69	3.69	3.74
4000.0	3.65	3.66	3.68	3.71
4200.0	3.63	3.63	3.66	3.67
4400.0	3.69	3.67	3.70	3.70
4600.0	3.84	3.83	3.83	3.85
4800.0	4.00	3.99	3.99	4.01
5000.0	4.10	4.09	4.10	4.12
5200.0	4.11	4.09	4.12	4.13
5400.0	4.10	4.05	4.11	4.10
5600.0	4.14	4.02	4.14	4.07
5800.0	4.23	4.12	4.23	4.14
5900.0	4.27	4.20	4.26	4.21
6000.0	4.32	4.28	4.30	4.28
6200.0	4.41	4.37	4.41	4.38
6400.0	4.53	4.43	4.53	4.47
6600.0	4.66	4.50	4.66	4.55
6800.0	4.79	4.60	4.79	4.66
7000.0	4.93	4.74	4.92	4.78
7200.0	5.01	4.85	5.00	4.88
7400.0	5.04	4.97	5.02	5.00
7600.0	5.17	5.04	5.13	5.08
7800.0	5.35	5.18	5.30	5.24
8000.0	5.50	5.34	5.44	5.42

**Notes**

- A. Performance and quality attributes and conditions not expressly stated in this specification document are intended to be excluded and do not form a part of this specification document.
- B. Electrical specifications and performance data contained in this specification document are based on Mini-Circuits' applicable established test performance criteria and measurement instructions.
- C. The parts covered by this specification document are subject to Mini-Circuits standard limited warranty and terms and conditions (collectively, "Standard Terms"); Purchasers of this part are entitled to the rights and benefits contained therein. For a full statement of the Standard Terms and the exclusive rights and remedies thereunder, please visit Mini-Circuits' website at [www.minicircuits.com/MCLStore/terms.jsp](http://www.minicircuits.com/MCLStore/terms.jsp)



# Solid State USB / I<sup>2</sup>C RF SP4T Switch

## U2C-1SP4T-63H

### Typical Performance Data

TEST CONDITIONS: @Temperature = +25°C, Pin=8dBm

FREQUENCY (MHz)	VSWR, Active Ports					VSWR, Internally Terminated Ports			
	COM	J1	(:1)			(:1)			
			J2	J3	J4	J1	J2	J3	J4
0.1	1.97	1.97	1.97	1.97	1.97	1.43	1.43	1.42	1.43
0.5	1.47	1.47	1.47	1.47	1.47	1.16	1.16	1.16	1.16
1.0	1.44	1.44	1.44	1.44	1.44	1.15	1.14	1.14	1.15
2.0	1.42	1.42	1.41	1.42	1.42	1.14	1.13	1.14	1.14
4.0	1.40	1.40	1.40	1.40	1.40	1.13	1.13	1.13	1.13
10.0	1.39	1.39	1.39	1.39	1.39	1.13	1.13	1.13	1.13
50.0	1.38	1.38	1.38	1.39	1.39	1.13	1.12	1.13	1.13
100.0	1.37	1.38	1.38	1.38	1.38	1.13	1.13	1.13	1.13
200.0	1.35	1.35	1.35	1.36	1.36	1.13	1.13	1.13	1.13
300.0	1.31	1.32	1.32	1.32	1.32	1.13	1.13	1.13	1.13
400.0	1.26	1.27	1.27	1.28	1.28	1.13	1.13	1.13	1.13
500.0	1.21	1.22	1.22	1.23	1.23	1.13	1.13	1.13	1.13
600.0	1.16	1.17	1.17	1.17	1.18	1.13	1.13	1.13	1.13
800.0	1.09	1.09	1.08	1.10	1.10	1.13	1.12	1.13	1.13
1000.0	1.14	1.12	1.12	1.13	1.12	1.13	1.12	1.13	1.12
1200.0	1.23	1.21	1.20	1.21	1.19	1.12	1.12	1.12	1.12
1400.0	1.29	1.28	1.26	1.28	1.26	1.12	1.11	1.12	1.11
1600.0	1.28	1.30	1.29	1.31	1.30	1.11	1.10	1.11	1.11
1800.0	1.21	1.28	1.28	1.29	1.29	1.11	1.09	1.10	1.10
2000.0	1.11	1.24	1.25	1.23	1.27	1.10	1.08	1.09	1.09
2200.0	1.04	1.17	1.21	1.17	1.22	1.09	1.07	1.08	1.08
2400.0	1.09	1.12	1.16	1.12	1.16	1.08	1.06	1.07	1.07
2600.0	1.12	1.08	1.10	1.09	1.09	1.07	1.05	1.06	1.07
2800.0	1.09	1.07	1.04	1.08	1.03	1.06	1.04	1.05	1.06
3000.0	1.02	1.12	1.10	1.11	1.11	1.06	1.04	1.04	1.06
3200.0	1.09	1.21	1.22	1.19	1.22	1.06	1.04	1.04	1.06
3400.0	1.19	1.30	1.33	1.27	1.32	1.07	1.05	1.04	1.07
3600.0	1.26	1.35	1.40	1.32	1.38	1.08	1.07	1.05	1.08
3800.0	1.26	1.34	1.41	1.33	1.38	1.09	1.08	1.07	1.09
4000.0	1.20	1.29	1.34	1.29	1.32	1.10	1.10	1.08	1.10
4200.0	1.12	1.20	1.22	1.22	1.21	1.12	1.11	1.09	1.12
4400.0	1.16	1.11	1.08	1.13	1.09	1.14	1.13	1.10	1.13
4600.0	1.27	1.05	1.03	1.07	1.02	1.16	1.14	1.12	1.15
4800.0	1.32	1.05	1.12	1.02	1.08	1.18	1.16	1.13	1.17
5000.0	1.30	1.08	1.16	1.07	1.12	1.19	1.18	1.14	1.18
5200.0	1.21	1.17	1.18	1.17	1.16	1.21	1.20	1.15	1.20
5400.0	1.12	1.29	1.20	1.29	1.22	1.23	1.21	1.16	1.21
5600.0	1.19	1.40	1.25	1.41	1.29	1.24	1.22	1.17	1.22
5800.0	1.32	1.44	1.27	1.47	1.33	1.25	1.24	1.18	1.23
5900.0	1.35	1.43	1.28	1.47	1.34	1.25	1.24	1.18	1.23
6000.0	1.40	1.40	1.26	1.43	1.32	1.25	1.25	1.17	1.24
6200.0	1.43	1.35	1.21	1.37	1.27	1.25	1.25	1.17	1.24
6400.0	1.47	1.42	1.25	1.41	1.30	1.25	1.25	1.18	1.24
6600.0	1.54	1.60	1.41	1.57	1.45	1.24	1.24	1.19	1.24
6800.0	1.60	1.75	1.58	1.72	1.62	1.24	1.24	1.19	1.23
7000.0	1.59	1.79	1.66	1.77	1.71	1.24	1.23	1.21	1.23
7200.0	1.51	1.65	1.59	1.67	1.64	1.23	1.21	1.24	1.22
7400.0	1.45	1.49	1.44	1.48	1.50	1.23	1.20	1.26	1.22
7600.0	1.55	1.47	1.37	1.42	1.42	1.25	1.20	1.30	1.23
7800.0	1.74	1.61	1.49	1.55	1.54	1.28	1.21	1.36	1.26
8000.0	1.85	1.76	1.67	1.70	1.72	1.32	1.24	1.43	1.31

**Notes**

- A. Performance and quality attributes and conditions not expressly stated in this specification document are intended to be excluded and do not form a part of this specification document.
- B. Electrical specifications and performance data contained in this specification document are based on Mini-Circuits' applicable established test performance criteria and measurement instructions.
- C. The parts covered by this specification document are subject to Mini-Circuits standard limited warranty and terms and conditions (collectively, "Standard Terms"); Purchasers of this part are entitled to the rights and benefits contained therein. For a full statement of the Standard Terms and the exclusive rights and remedies thereunder, please visit Mini-Circuits' website at [www.minicircuits.com/MCLStore/terms.jsp](http://www.minicircuits.com/MCLStore/terms.jsp)





# Solid State USB / I<sup>2</sup>C RF SP4T Switch

## U2C-1SP4T-63H

### Typical Performance Data

TEST CONDITIONS: @Temperature = +25°C, Pin=8dBm

FREQUENCY (MHz)	ISOLATION						
	(dB)						
	COM-J1 @J3 Active	COM-J1 @J2 Active	J2-J3 @J3 Active	J2-J3 @J1 Active	J1-J2 @J1 Active	COM-J1 @ Disconnect	COM-J4 @ Disconnect
0.1	101.93	102.79	101.60	89.59	95.93	88.88	96.42
0.5	100.16	97.33	90.29	100.14	100.91	82.90	93.73
1.0	115.34	96.75	95.55	94.79	92.97	80.03	96.30
2.0	107.45	92.45	97.21	98.28	95.48	76.44	94.11
4.0	94.86	92.99	91.65	92.16	97.10	74.30	96.30
10.0	117.58	106.19	104.17	103.84	110.56	72.61	116.74
50.0	112.79	106.83	100.16	103.51	112.24	68.38	118.11
100.0	116.71	107.48	106.04	100.81	111.27	64.15	119.57
200.0	111.90	111.80	104.69	100.22	118.88	59.42	114.91
300.0	116.86	106.33	103.73	101.78	110.61	56.48	114.25
400.0	109.28	110.22	105.77	99.70	108.38	54.27	128.11
500.0	126.27	106.88	104.69	117.14	128.79	52.46	111.93
600.0	112.71	105.07	104.87	109.65	119.22	50.95	114.39
800.0	116.98	102.39	111.50	104.03	121.89	48.61	116.39
1000.0	101.04	104.93	113.49	108.11	109.03	46.97	129.05
1200.0	95.40	99.18	104.61	104.00	111.95	45.78	118.73
1400.0	90.38	100.67	104.99	104.78	114.42	44.74	121.23
1600.0	91.88	96.60	103.01	99.85	122.08	43.66	113.68
1800.0	91.93	94.97	102.22	92.22	95.55	42.42	114.51
2000.0	91.47	92.36	101.56	101.30	97.99	41.09	114.17
2200.0	90.10	90.64	102.62	98.78	92.36	39.89	111.14
2400.0	84.58	85.28	102.57	101.14	83.53	39.10	115.42
2600.0	80.94	85.24	104.32	98.51	91.62	38.72	114.11
2800.0	77.24	83.67	98.25	91.88	92.10	38.46	114.05
3000.0	76.57	82.71	91.86	85.19	87.06	38.04	122.09
3200.0	79.62	81.49	86.74	80.13	86.26	37.32	106.57
3400.0	79.79	78.90	93.59	87.69	94.47	36.37	110.82
3600.0	77.86	77.09	94.34	86.74	94.58	35.55	123.28
3800.0	74.73	75.35	93.48	79.56	87.92	35.23	108.77
4000.0	70.64	73.46	92.67	73.79	80.98	35.36	117.47
4200.0	68.15	71.34	104.09	81.87	88.48	35.51	115.77
4400.0	69.01	69.18	110.56	85.33	91.09	35.39	113.43
4600.0	71.41	67.16	102.97	87.83	91.59	34.94	117.98
4800.0	72.76	65.34	98.07	89.08	90.56	34.39	104.24
5000.0	71.86	63.62	96.53	88.43	87.16	34.05	99.67
5200.0	68.79	62.16	92.05	86.83	80.67	34.01	107.41
5400.0	65.25	61.35	95.92	90.13	78.92	34.02	110.93
5600.0	62.53	60.87	90.36	83.90	79.06	33.81	110.38
5800.0	62.51	60.94	86.28	74.92	74.17	33.34	97.41
5900.0	63.18	61.16	87.01	74.81	75.75	33.04	99.19
6000.0	63.85	61.43	86.82	74.93	77.21	32.71	96.09
6200.0	64.58	61.75	89.37	74.85	78.90	32.21	93.23
6400.0	64.17	61.99	96.65	74.65	79.95	31.96	92.02
6600.0	62.82	62.17	99.04	71.67	78.42	31.88	94.13
6800.0	60.69	62.02	88.58	67.24	74.49	31.68	96.51
7000.0	57.90	61.93	92.25	71.06	78.53	31.20	94.43
7200.0	56.65	61.52	94.30	76.00	83.39	30.51	91.63
7400.0	57.60	61.12	88.35	77.41	83.60	29.90	85.70
7600.0	58.38	60.57	85.51	77.24	83.50	29.66	84.94
7800.0	58.26	59.84	86.66	76.57	80.59	29.70	83.94
8000.0	57.47	59.11	90.82	75.40	77.43	29.66	83.16

**Notes**

- A. Performance and quality attributes and conditions not expressly stated in this specification document are intended to be excluded and do not form a part of this specification document.
- B. Electrical specifications and performance data contained in this specification document are based on Mini-Circuits' applicable established test performance criteria and measurement instructions.
- C. The parts covered by this specification document are subject to Mini-Circuits standard limited warranty and terms and conditions (collectively, "Standard Terms"); Purchasers of this part are entitled to the rights and benefits contained therein. For a full statement of the Standard Terms and the exclusive rights and remedies thereunder, please visit Mini-Circuits' website at [www.minicircuits.com/MCLStore/terms.jsp](http://www.minicircuits.com/MCLStore/terms.jsp)



# Solid State USB / I<sup>2</sup>C RF SP4T Switch

## U2C-1SP4T-63H

### Typical Performance Data

TEST CONDITIONS: @Temperature = +50°C, Pin=8dBm

FREQUENCY (MHz)	INSERTION LOSS			
	(dB)			
	COM-J1	COM-J2	COM-J3	COM-J4
0.1	2.27	2.26	2.28	2.28
0.5	1.93	1.92	1.94	1.94
1.0	1.95	1.95	1.97	1.97
2.0	2.03	2.02	2.04	2.04
4.0	2.09	2.08	2.10	2.10
10.0	2.13	2.12	2.14	2.14
50.0	2.18	2.17	2.19	2.19
100.0	2.24	2.24	2.25	2.26
200.0	2.32	2.31	2.33	2.33
300.0	2.39	2.38	2.40	2.41
400.0	2.46	2.45	2.47	2.47
500.0	2.53	2.51	2.54	2.53
600.0	2.59	2.57	2.60	2.59
800.0	2.70	2.68	2.71	2.70
1000.0	2.77	2.75	2.78	2.77
1200.0	2.80	2.79	2.81	2.81
1400.0	2.81	2.80	2.82	2.82
1600.0	2.82	2.81	2.83	2.84
1800.0	2.86	2.86	2.86	2.89
2000.0	2.94	2.95	2.94	2.98
2200.0	3.05	3.06	3.05	3.08
2400.0	3.15	3.16	3.15	3.18
2600.0	3.22	3.22	3.23	3.25
2800.0	3.27	3.28	3.28	3.31
3000.0	3.35	3.35	3.35	3.39
3200.0	3.48	3.49	3.47	3.53
3400.0	3.63	3.66	3.63	3.70
3600.0	3.75	3.79	3.77	3.85
3800.0	3.80	3.85	3.82	3.90
4000.0	3.78	3.82	3.80	3.87
4200.0	3.78	3.78	3.78	3.82
4400.0	3.85	3.84	3.82	3.85
4600.0	4.00	3.99	3.96	4.00
4800.0	4.16	4.16	4.12	4.17
5000.0	4.26	4.26	4.23	4.28
5200.0	4.28	4.26	4.26	4.29
5400.0	4.27	4.22	4.25	4.26
5600.0	4.31	4.20	4.28	4.23
5800.0	4.39	4.29	4.36	4.30
5900.0	4.43	4.38	4.41	4.39
6000.0	4.47	4.46	4.45	4.46
6200.0	4.58	4.56	4.55	4.56
6400.0	4.70	4.63	4.67	4.64
6600.0	4.82	4.69	4.80	4.73
6800.0	4.95	4.80	4.92	4.84
7000.0	5.08	4.92	5.06	4.96
7200.0	5.17	5.05	5.14	5.07
7400.0	5.24	5.19	5.19	5.20
7600.0	5.38	5.27	5.31	5.28
7800.0	5.56	5.40	5.47	5.43
8000.0	5.72	5.57	5.63	5.62

**Notes**

- A. Performance and quality attributes and conditions not expressly stated in this specification document are intended to be excluded and do not form a part of this specification document.
- B. Electrical specifications and performance data contained in this specification document are based on Mini-Circuits' applicable established test performance criteria and measurement instructions.
- C. The parts covered by this specification document are subject to Mini-Circuits standard limited warranty and terms and conditions (collectively, "Standard Terms"); Purchasers of this part are entitled to the rights and benefits contained therein. For a full statement of the Standard Terms and the exclusive rights and remedies thereunder, please visit Mini-Circuits' website at [www.minicircuits.com/MCLStore/terms.jsp](http://www.minicircuits.com/MCLStore/terms.jsp)



# Solid State USB / I<sup>2</sup>C RF SP4T Switch

## U2C-1SP4T-63H

### Typical Performance Data

TEST CONDITIONS: @Temperature = +50°C, Pin=8dBm

FREQUENCY (MHz)	VSWR, Active Ports					VSWR, Internally Terminated Ports			
	COM	J1	(:1)			(:1)			
			J2	J3	J4	J1	J2	J3	J4
0.1	1.99	1.99	1.99	1.99	1.99	1.43	1.43	1.43	1.44
0.5	1.50	1.50	1.50	1.50	1.50	1.17	1.17	1.17	1.17
1.0	1.47	1.47	1.47	1.48	1.47	1.16	1.15	1.16	1.16
2.0	1.45	1.45	1.44	1.45	1.45	1.15	1.15	1.15	1.15
4.0	1.43	1.43	1.43	1.43	1.43	1.14	1.14	1.14	1.14
10.0	1.42	1.42	1.42	1.42	1.42	1.14	1.14	1.14	1.14
50.0	1.41	1.41	1.41	1.41	1.41	1.14	1.13	1.14	1.14
100.0	1.40	1.40	1.40	1.40	1.40	1.13	1.13	1.13	1.13
200.0	1.37	1.37	1.37	1.38	1.38	1.13	1.13	1.13	1.13
300.0	1.33	1.34	1.34	1.34	1.34	1.13	1.13	1.13	1.13
400.0	1.28	1.29	1.29	1.30	1.30	1.14	1.13	1.14	1.14
500.0	1.23	1.23	1.23	1.24	1.24	1.14	1.14	1.14	1.14
600.0	1.17	1.18	1.18	1.19	1.19	1.14	1.13	1.14	1.14
800.0	1.08	1.10	1.10	1.11	1.11	1.14	1.13	1.14	1.14
1000.0	1.14	1.13	1.13	1.14	1.13	1.14	1.13	1.14	1.14
1200.0	1.24	1.22	1.21	1.23	1.21	1.13	1.13	1.13	1.13
1400.0	1.30	1.29	1.28	1.30	1.28	1.13	1.12	1.13	1.13
1600.0	1.29	1.32	1.31	1.32	1.31	1.13	1.11	1.12	1.12
1800.0	1.23	1.30	1.29	1.30	1.30	1.12	1.10	1.11	1.11
2000.0	1.12	1.25	1.26	1.24	1.27	1.11	1.09	1.10	1.10
2200.0	1.05	1.18	1.21	1.17	1.22	1.10	1.08	1.09	1.09
2400.0	1.08	1.12	1.16	1.12	1.16	1.09	1.06	1.08	1.08
2600.0	1.11	1.07	1.09	1.09	1.09	1.08	1.06	1.06	1.07
2800.0	1.09	1.07	1.03	1.08	1.03	1.07	1.05	1.05	1.07
3000.0	1.02	1.14	1.11	1.12	1.11	1.07	1.05	1.05	1.06
3200.0	1.09	1.23	1.22	1.19	1.22	1.08	1.05	1.04	1.07
3400.0	1.18	1.30	1.33	1.27	1.32	1.09	1.06	1.05	1.07
3600.0	1.24	1.33	1.39	1.32	1.38	1.10	1.07	1.06	1.08
3800.0	1.23	1.32	1.39	1.33	1.37	1.11	1.08	1.07	1.09
4000.0	1.17	1.26	1.33	1.29	1.32	1.13	1.10	1.08	1.10
4200.0	1.11	1.19	1.21	1.21	1.21	1.14	1.11	1.09	1.12
4400.0	1.17	1.13	1.08	1.13	1.09	1.15	1.13	1.11	1.14
4600.0	1.27	1.08	1.03	1.07	1.02	1.17	1.14	1.13	1.15
4800.0	1.32	1.03	1.11	1.03	1.09	1.18	1.17	1.14	1.18
5000.0	1.28	1.07	1.15	1.05	1.11	1.20	1.18	1.15	1.19
5200.0	1.20	1.20	1.16	1.16	1.14	1.21	1.20	1.16	1.21
5400.0	1.13	1.34	1.21	1.30	1.22	1.22	1.21	1.18	1.22
5600.0	1.20	1.44	1.26	1.44	1.30	1.22	1.23	1.20	1.24
5800.0	1.32	1.46	1.29	1.50	1.35	1.23	1.23	1.20	1.24
5900.0	1.36	1.44	1.30	1.50	1.36	1.22	1.24	1.20	1.25
6000.0	1.40	1.41	1.28	1.48	1.34	1.22	1.24	1.20	1.25
6200.0	1.45	1.37	1.24	1.43	1.30	1.22	1.24	1.19	1.24
6400.0	1.49	1.43	1.27	1.46	1.33	1.22	1.24	1.19	1.24
6600.0	1.52	1.58	1.42	1.60	1.46	1.22	1.23	1.20	1.24
6800.0	1.54	1.71	1.57	1.74	1.62	1.21	1.22	1.21	1.23
7000.0	1.53	1.73	1.63	1.76	1.69	1.21	1.21	1.22	1.22
7200.0	1.47	1.61	1.56	1.64	1.62	1.20	1.19	1.23	1.21
7400.0	1.43	1.47	1.44	1.48	1.50	1.21	1.19	1.25	1.21
7600.0	1.54	1.44	1.36	1.42	1.41	1.23	1.18	1.29	1.22
7800.0	1.70	1.58	1.46	1.54	1.51	1.27	1.20	1.36	1.25
8000.0	1.79	1.71	1.62	1.67	1.67	1.31	1.23	1.43	1.30

**Notes**

- A. Performance and quality attributes and conditions not expressly stated in this specification document are intended to be excluded and do not form a part of this specification document.
- B. Electrical specifications and performance data contained in this specification document are based on Mini-Circuits' applicable established test performance criteria and measurement instructions.
- C. The parts covered by this specification document are subject to Mini-Circuits standard limited warranty and terms and conditions (collectively, "Standard Terms"); Purchasers of this part are entitled to the rights and benefits contained therein. For a full statement of the Standard Terms and the exclusive rights and remedies thereunder, please visit Mini-Circuits' website at [www.minicircuits.com/MCLStore/terms.jsp](http://www.minicircuits.com/MCLStore/terms.jsp)



# Solid State USB / I<sup>2</sup>C RF SP4T Switch

## U2C-1SP4T-63H

### Typical Performance Data

TEST CONDITIONS: @Temperature = +50°C, Pin=8dBm

FREQUENCY (MHz)	ISOLATION						
	(dB)						
	COM-J1 @J3 Active	COM-J1 @J2 Active	J2-J3 @J3 Active	J2-J3 @J1 Active	J1-J2 @J1 Active	COM-J1 @ Disconnect	COM-J4 @ Disconnect
0.1	93.11	95.05	106.05	95.09	93.53	88.68	97.26
0.5	103.39	98.60	91.74	102.46	93.84	84.78	97.71
1.0	98.58	100.39	99.86	96.64	95.77	78.33	98.48
2.0	95.54	98.16	98.66	96.77	102.88	75.12	109.57
4.0	94.96	101.77	94.29	91.97	106.01	72.44	104.33
10.0	108.14	108.29	107.53	108.38	114.32	71.78	114.08
50.0	107.58	109.96	103.34	106.64	131.07	68.11	117.22
100.0	111.59	103.24	113.57	105.56	109.30	64.29	117.23
200.0	117.66	108.18	108.54	105.05	125.97	59.71	117.70
300.0	111.53	114.87	107.01	107.13	110.12	56.84	118.36
400.0	114.57	109.65	107.96	104.46	111.44	54.66	119.63
500.0	111.29	110.83	112.76	116.10	114.23	52.88	117.16
600.0	122.82	106.62	104.76	108.76	120.70	51.41	123.52
800.0	106.85	102.85	115.27	107.50	108.89	49.09	111.49
1000.0	101.02	106.64	109.31	113.26	107.64	47.47	112.90
1200.0	95.88	103.27	108.33	108.83	125.68	46.28	122.93
1400.0	91.90	101.51	115.09	110.56	106.35	45.24	120.80
1600.0	92.28	97.25	105.92	104.21	118.47	44.14	121.93
1800.0	91.95	96.45	103.53	93.50	99.76	42.89	107.75
2000.0	92.53	95.24	106.12	100.35	103.85	41.56	111.31
2200.0	89.15	92.43	106.47	98.32	92.16	40.36	115.68
2400.0	85.32	86.08	108.47	106.17	83.78	39.58	132.67
2600.0	81.27	85.49	103.37	95.80	90.88	39.20	113.96
2800.0	77.82	83.96	96.98	91.59	90.44	38.94	110.67
3000.0	77.59	83.06	92.51	84.32	87.68	38.51	110.88
3200.0	80.14	81.93	88.77	81.69	87.39	37.77	108.21
3400.0	80.16	79.54	93.22	88.35	95.80	36.82	123.92
3600.0	78.20	77.68	96.54	85.71	95.27	36.01	115.97
3800.0	74.88	75.79	91.96	79.01	85.87	35.71	115.64
4000.0	71.02	74.03	93.97	75.56	82.79	35.84	115.59
4200.0	68.72	71.63	107.72	82.53	88.32	35.98	114.83
4400.0	69.59	69.55	102.39	86.01	90.21	35.84	128.91
4600.0	72.06	67.63	100.61	88.19	91.93	35.39	106.85
4800.0	73.23	65.96	99.96	89.80	90.40	34.86	102.50
5000.0	72.32	64.34	95.53	89.34	86.97	34.53	102.13
5200.0	69.12	62.96	93.09	87.83	80.39	34.47	108.42
5400.0	65.69	62.15	99.50	91.79	80.16	34.43	118.48
5600.0	63.20	61.66	91.30	83.29	78.72	34.20	102.65
5800.0	63.17	61.66	86.61	74.98	74.95	33.72	100.21
5900.0	63.71	61.84	88.03	75.43	76.90	33.42	97.39
6000.0	64.28	62.09	86.91	75.11	77.80	33.11	97.23
6200.0	64.91	62.27	89.92	75.14	79.78	32.59	93.74
6400.0	64.48	62.38	93.98	74.36	80.01	32.33	92.35
6600.0	63.21	62.47	95.21	71.49	77.89	32.22	98.58
6800.0	61.13	62.33	87.76	67.74	75.14	31.99	93.53
7000.0	58.41	62.18	94.60	72.54	80.73	31.52	96.17
7200.0	57.18	61.86	93.53	76.89	83.48	30.87	90.41
7400.0	58.06	61.42	89.12	77.82	84.42	30.30	85.86
7600.0	58.75	60.88	87.91	77.95	83.38	30.05	85.94
7800.0	58.61	60.22	88.68	75.84	79.96	30.08	83.79
8000.0	57.85	59.52	91.15	76.40	77.51	30.11	83.70

**Notes**

- A. Performance and quality attributes and conditions not expressly stated in this specification document are intended to be excluded and do not form a part of this specification document.
- B. Electrical specifications and performance data contained in this specification document are based on Mini-Circuits' applicable established test performance criteria and measurement instructions.
- C. The parts covered by this specification document are subject to Mini-Circuits standard limited warranty and terms and conditions (collectively, "Standard Terms"); Purchasers of this part are entitled to the rights and benefits contained therein. For a full statement of the Standard Terms and the exclusive rights and remedies thereunder, please visit Mini-Circuits' website at [www.minicircuits.com/MCLStore/terms.jsp](http://www.minicircuits.com/MCLStore/terms.jsp)



# Solid State USB / I<sup>2</sup>C RF SP4T Switch Typical Performance Curves

## U2C-1SP4T-63H

TEST CONDITIONS: @Temperature = 0°C, Pin=8dBm

Insertion Loss

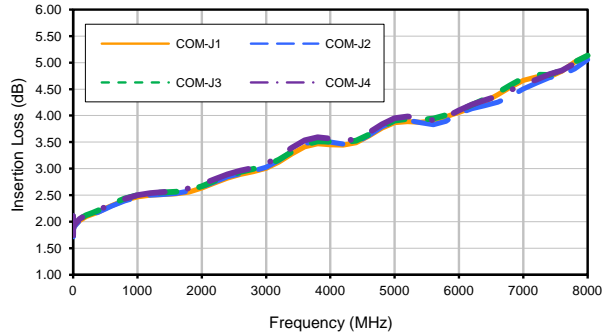

Isolation

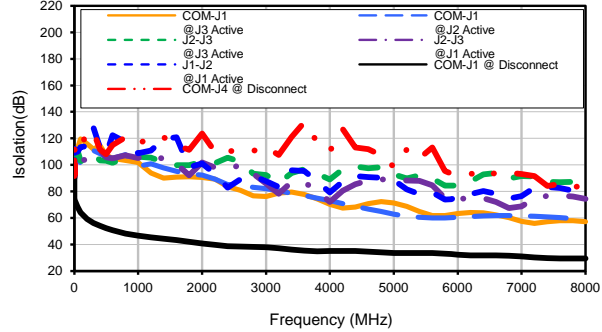

VSWR (COM)

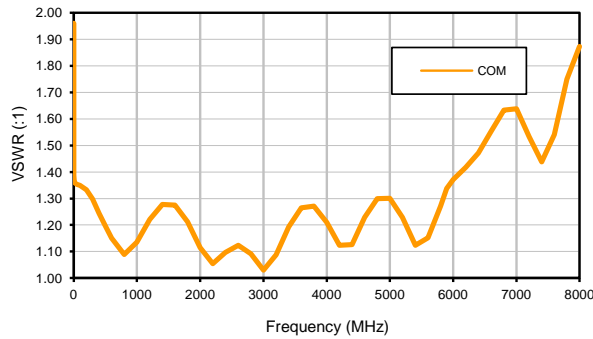

VSWR, Internally Terminated Ports

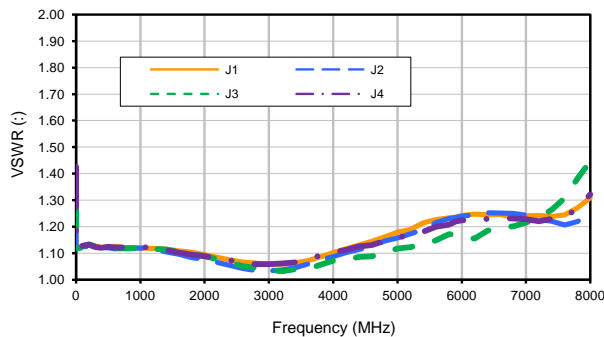

VSWR, Active Ports

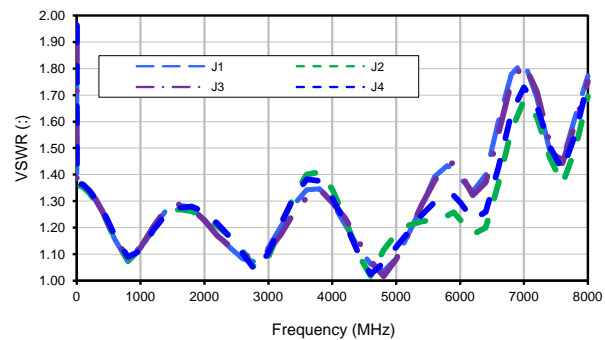

**Notes**

- A. Performance and quality attributes and conditions not expressly stated in this specification document are intended to be excluded and do not form a part of this specification document.
- B. Electrical specifications and performance data contained in this specification document are based on Mini-Circuit's applicable established test performance criteria and measurement instructions.
- C. The parts covered by this specification document are subject to Mini-Circuits standard limited warranty and terms and conditions (collectively, "Standard Terms"); Purchasers of this part are entitled to the rights and benefits contained therein. For a full statement of the Standard Terms and the exclusive rights and remedies thereunder, please visit Mini-Circuits' website at [www.minicircuits.com/MCLStore/terms.jsp](http://www.minicircuits.com/MCLStore/terms.jsp)



# Solid State USB / I<sup>2</sup>C RF SP4T Switch Typical Performance Curves

## U2C-1SP4T-63H

TEST CONDITIONS: @Temperature = +25°C, Pin=8dBm

Insertion Loss

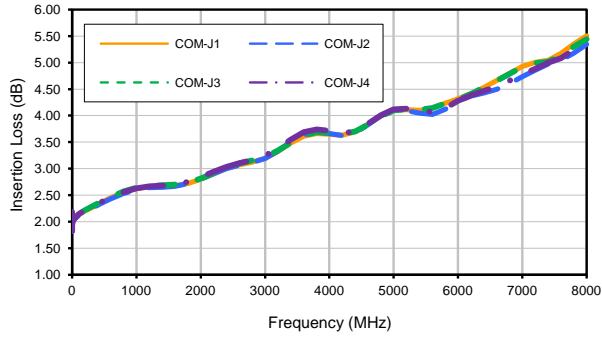

Isolation

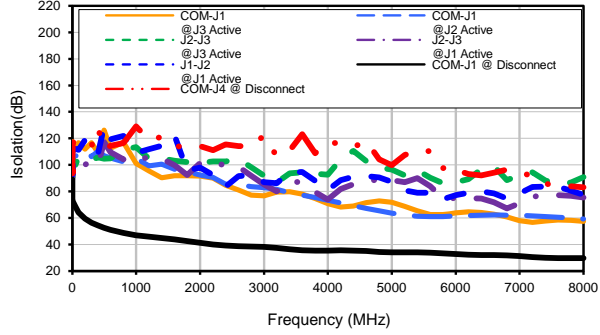

VSWR (COM)

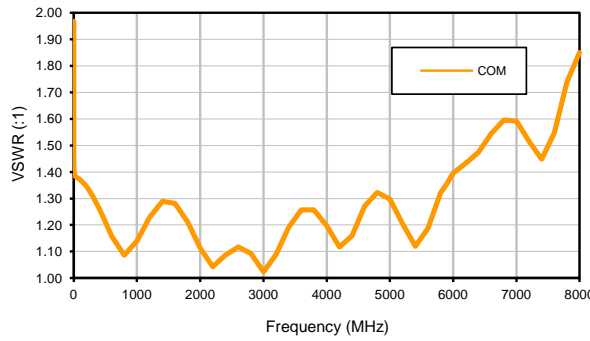

VSWR, Internally Terminated Ports

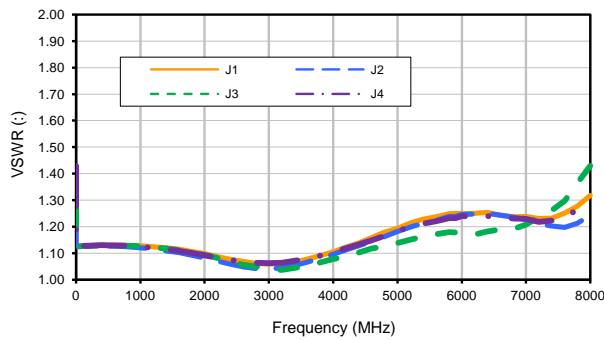

VSWR, Active Ports

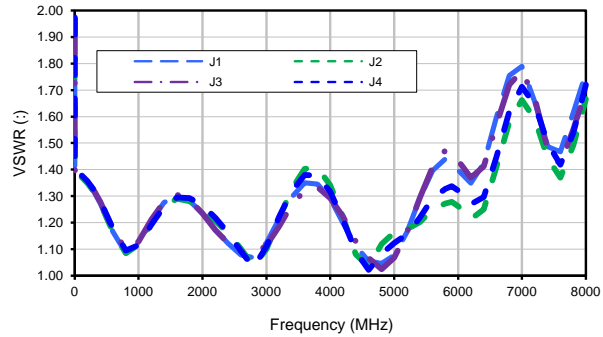

**Notes**

- A. Performance and quality attributes and conditions not expressly stated in this specification document are intended to be excluded and do not form a part of this specification document.
- B. Electrical specifications and performance data contained in this specification document are based on Mini-Circuit's applicable established test performance criteria and measurement instructions.
- C. The parts covered by this specification document are subject to Mini-Circuit's standard limited warranty and terms and conditions (collectively, "Standard Terms"); Purchasers of this part are entitled to the rights and benefits contained therein. For a full statement of the Standard Terms and the exclusive rights and remedies thereunder, please visit Mini-Circuit's website at [www.minicircuits.com/MCLStore/terms.jsp](http://www.minicircuits.com/MCLStore/terms.jsp)



# Solid State USB / I<sup>2</sup>C RF SP4T Switch

## Typical Performance Curves

# U2C-1SP4T-63H

TEST CONDITIONS: @Temperature = +50°C, Pin=8dBm

**Insertion Loss**

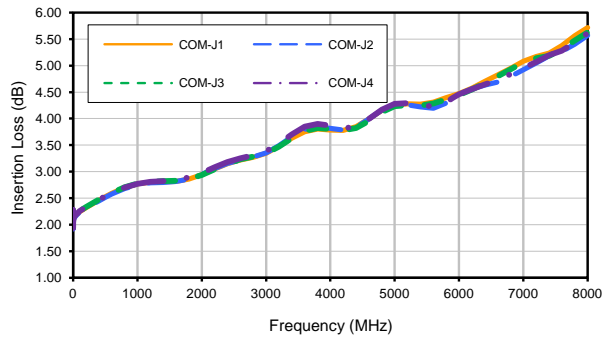

**Isolation**

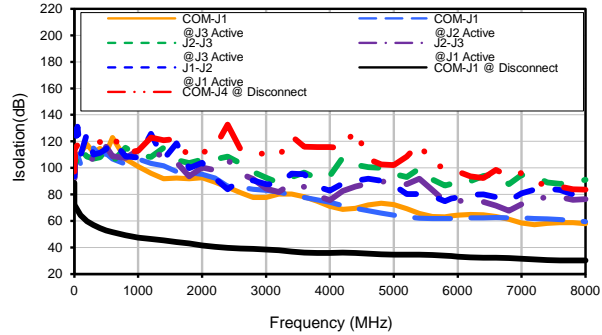

**VSWR (COM)**

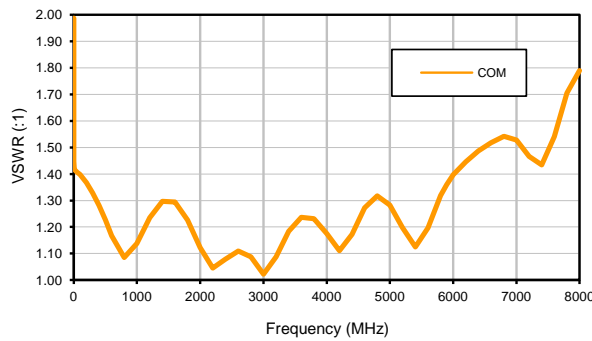

**VSWR, Internally Terminated Ports**

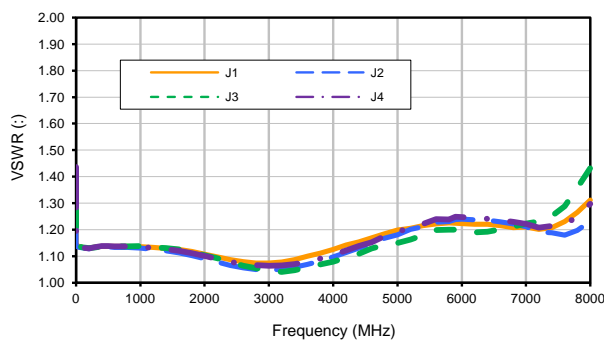

**VSWR, Active Ports**

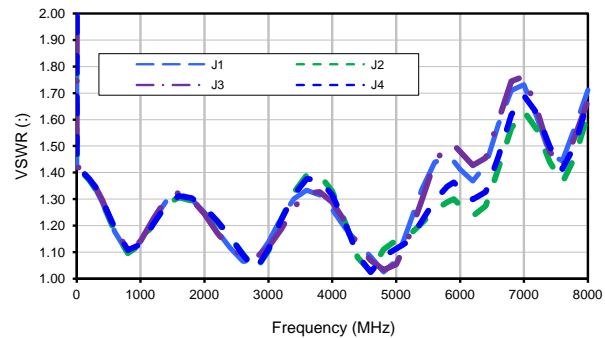

**Notes**

- A. Performance and quality attributes and conditions not expressly stated in this specification document are intended to be excluded and do not form a part of this specification document.
- B. Electrical specifications and performance data contained in this specification document are based on Mini-Circuit's applicable established test performance criteria and measurement instructions.
- C. The parts covered by this specification document are subject to Mini-Circuit's standard limited warranty and terms and conditions (collectively, "Standard Terms"); Purchasers of this part are entitled to the rights and benefits contained therein. For a full statement of the Standard Terms and the exclusive rights and remedies thereunder, please visit Mini-Circuit's website at [www.minicircuits.com/MCLStore/terms.jsp](http://www.minicircuits.com/MCLStore/terms.jsp)



# Case Style

# RB

## Outline Dimensions

## RB2502

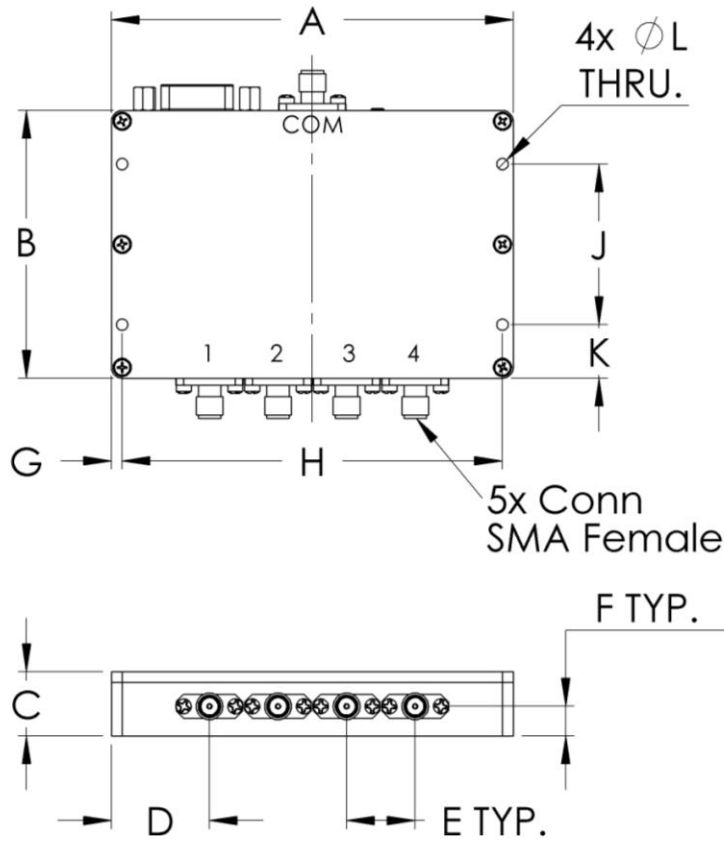
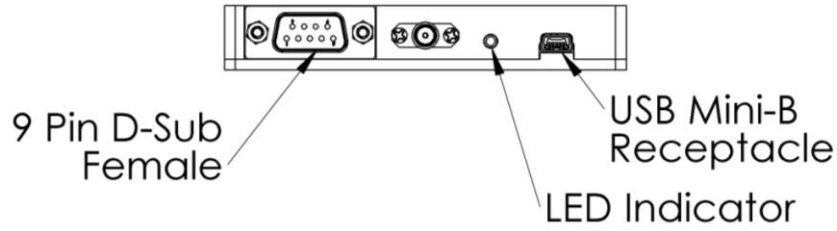

CASE#	A	B	C	D	E	F	G	H	J	K	L	WT. GRAMS
RB2502	3.75 (95.25)	2.50 (63.50)	.60 (15.24)	.915 (23.24)	.640 (16.26)	.278 (7.06)	.10 (2.54)	3.550 (90.17)	1.500 (38.10)	.50 (12.70)	.106 (2.69)	220

Dimensions are in inches (mm). Tolerances: 2PL. +/- .03; 3PL. +/- .015

### Notes:

1. Case material: Aluminum alloy.
2. Case finish: Nickel Plate.

**Mini-Circuits**<sup>®</sup>

INTERNET <http://www.minicircuits.com>

P.O. Box 350166, Brooklyn, New York 11235-0003 (718) 934-4500 Fax (718) 332-4661

Distribution Centers NORTH AMERICA 800-654-7949 • 417-335-5935 • Fax 417-335-5945 • EUROPE 44-1252-832600 • Fax 44-1252-837010

Mini-Circuits ISO 9001 & ISO 14001 Certified





Environmental Specifications **ENV55**

All Mini-Circuits products are manufactured under exacting quality assurance and control standards, and are capable of meeting published specifications after being subjected to any or all of the following physical and environmental test.

Specification	Test/Inspection Condition	Reference/Spec
Operating Temperature	-0° to 50° C Ambient Environment	Individual Model Data Sheet
Storage Temperature	-20° to 60° C Ambient Environment	Individual Model Data Sheet
Operating and Storage Humidity	5% to 85% RH (non-condensing)	Ambient
Bench Handling Test	Bench Top Tip 45° & Drop	MIL-PRF-28800F
Transit Drop Test	Free Fall Drop, 20 cm (7.9 inches)	MIL-PRF-28800F Class 3