



Mini-Circuits

SURFACE MOUNT ^{top hat}

Power Splitter/Combiner TCP-2-152-75X+

75Ω 2 Way-0° 5 to 1500 MHz

FEATURES

- Low insertion, 0.8 dB typ.
- Excellent amplitude unbalance, 0.2 dB typ.
- Very good phase unbalance, 1.5 deg. typ.
- External resistor & capacitor required
- Aqueous washable
- Leads for excellent solderability
- Low cost



Generic photo used for illustration purposes only

CASE STYLE: DB1627

APPLICATIONS

- DOCSIS® 3.1 Systems
- VHF/UHF
- CATV
- Cellular

+RoHS Compliant

The +Suffix identifies RoHS Compliance. See our web site for RoHS Compliance methodologies and qualifications

ELECTRICAL SPECIFICATIONS AT 25°C

Parameter	Frequency (MHz)	Min.	Typ.	Max.	Unit
Frequency Range		5		1500	MHz
Insertion Loss, above 3.0 dB	5 - 50	—	0.4	0.7	dB
	50 - 1000	—	0.7	1.2	
	1000 - 1250	—	1.0	1.7	
	1250 - 1500	—	1.3	2.7	
Isolation	5 - 50	22	28	—	dB
	50 - 1000	21	28	—	
	1000 - 1250	20	28	—	
	1250 - 1500	16	25	—	
Phase Unbalance	5 - 50	—	1.0	3.0	Degree
	50 - 1000	—	1.5	4.0	
	1000 - 1250	—	2.0	5.0	
	1250 - 1500	—	2.0	6.0	
Amplitude Unbalance	5 - 50	—	0.2	0.4	dB
	50 - 1000	—	0.2	0.5	
	1000 - 1250	—	0.25	0.6	
	1250 - 1500	—	0.30	0.7	
VSWR (Port S)	5 - 50	—	1.08	1.15	:1
	50 - 1000	—	1.15	1.3	
	1000 - 1250	—	1.25	1.45	
	1250 - 1500	—	1.3	1.75	
VSWR (Port 1-2)	5 - 50	—	1.3	1.5	:1
	50 - 1000	—	1.2	1.35	
	1000 - 1250	—	1.3	1.6	
	1250 - 1500	—	1.55	1.95	

MAXIMUM RATINGS

Parameter	Ratings
Operating temperature	-40°C to 85°C
Storage temperature	-55°C to 100°C
RF Power Input (as splitter)	0.5 W max.

Permanent damage may occur if any of these limits are exceeded.

FUNCTIONAL SCHEMATIC

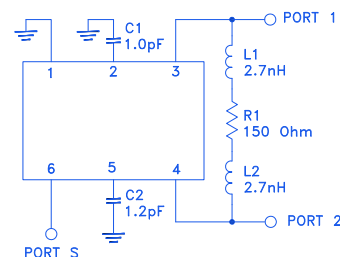



Power Splitter/Combiner **TCP-2-152-75X+**

PIN CONNECTIONS

SUM PORT	6
PORT 1	3
PORT 2	4
GROUND	1
EXT. CAPACITOR 1.0 pF	2 TO GND
EXT. CAPACITOR 1.2pF	5 TO GND
EXT. COMPONENTS (INDUCTOR 2.7 nH, RESISTOR 150Ω, INDUCTOR 2.7nH IN SERIES)	3,4

PRODUCT MARKING: SW

DEMO BOARD MCL P/N: TB-835 SUGGESTED PCB LAYOUT (PL-457)

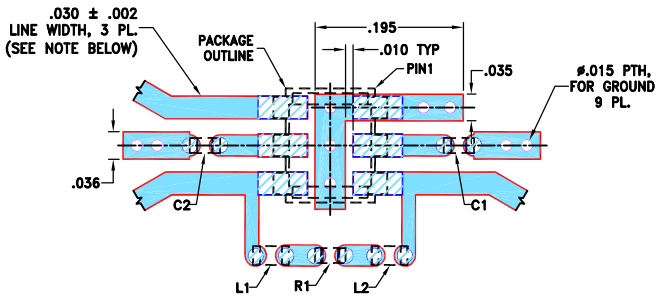

COMPONENT	SIZE
L1, L2	0402
C1, C2	0402
R1	0402

NOTES:

- TRACE WIDTH PARAMETERS ARE SHOWN FOR ROGERS R04350B WITH DIELECTRIC THICKNESS .030"±.002". COPPER: 1/2 OZ. EACH SIDE. FOR OTHER MATERIALS TRACE WIDTH AND GAP MAY NEED TO BE MODIFIED.
- BOTTOM SIDE OF THE PCB IS CONTINUOUS GROUND PLANE.

- DENOTES PCB COPPER LAYOUT WITH SMOBC (SOLDER MASK OVER BARE COPPER).
- DENOTES COPPER LAND PATTERN FREE OF SOLDER MASK.

OUTLINE DRAWING

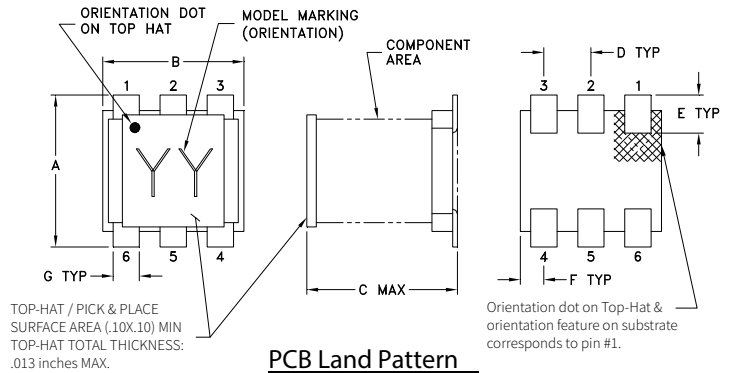

PCB Land Pattern

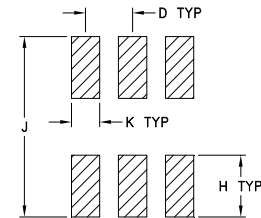

SUGGESTED LAYOUT TOLERANCE TO BE WITHIN ±.002

OUTLINE DIMENSIONS (Inches/mm)

A	B	C	D	E	F
.160	.150	.160	.050	.040	.025
4.06	3.81	4.06	1.27	1.02	0.64
G	H	J	K		wt
.028	.065	.190	.030		grams
0.71	1.65	4.83	0.76		0.15

TAPE & REEL INFORMATION: F47



Power Splitter/Combiner **TCP-2-152-75X+**

TYPICAL PERFORMANCE DATA AT 25°C

Frequency (MHz)	Total Loss ¹ (dB)		Amplitude Unbalance (dB)	Isolation (dB)	Phase Unbalance (deg.)	VSWR (:1)		
	S-1	S-2				S	1	2
5	3.46	3.24	0.22	27.24	0.82	1.08	1.34	1.27
50	3.42	3.24	0.19	35.10	0.05	1.06	1.25	1.20
100	3.44	3.25	0.19	34.55	0.19	1.07	1.24	1.20
150	3.45	3.27	0.19	34.13	0.30	1.07	1.23	1.20
200	3.46	3.28	0.18	33.83	0.39	1.08	1.23	1.18
300	3.48	3.30	0.18	33.30	0.56	1.10	1.21	1.17
400	3.49	3.32	0.17	33.19	0.71	1.11	1.18	1.16
500	3.51	3.36	0.15	33.41	0.80	1.13	1.16	1.16
600	3.53	3.40	0.13	33.62	0.90	1.14	1.13	1.15
700	3.55	3.45	0.10	34.18	0.99	1.15	1.10	1.15
800	3.58	3.51	0.07	35.21	1.03	1.16	1.08	1.16
900	3.63	3.59	0.04	36.95	1.06	1.16	1.08	1.17
1000	3.68	3.68	0.01	39.83	1.09	1.16	1.12	1.19
1250	3.88	3.97	0.10	33.87	1.19	1.16	1.24	1.25
1500	4.27	4.41	0.14	23.17	1.56	1.20	1.38	1.32

1. Total Loss = Insertion Loss + 3dB splitter loss.

TCP-2-152-75X+
TOTAL LOSS

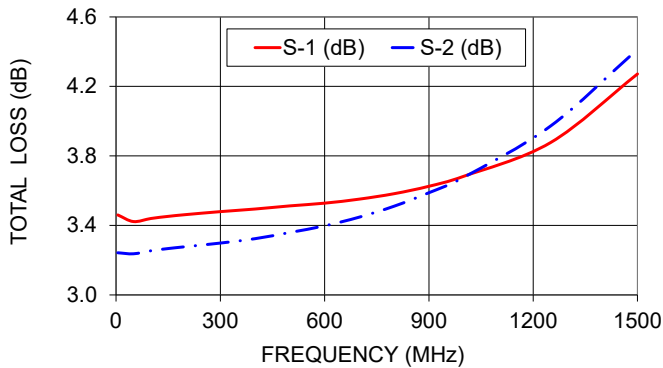

TCP-2-152-75X+
ISOLATION

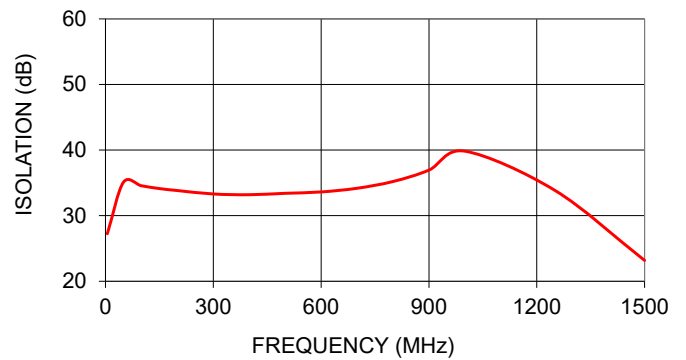

TCP-2-152-75X+
VSWR

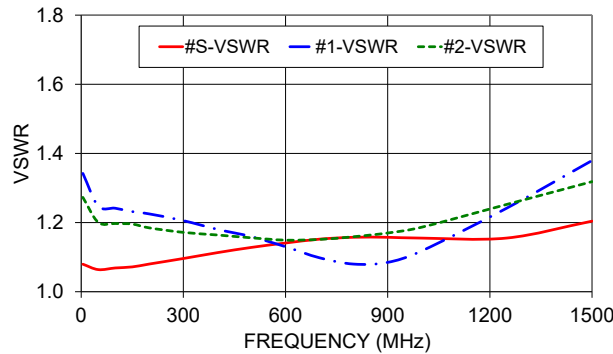

NOTES

- A. Performance and quality attributes and conditions not expressly stated in this specification document are intended to be excluded and do not form a part of this specification document.
- B. Electrical specifications and performance data contained in this specification document are based on Mini-Circuit's applicable established test performance criteria and measurement instructions.
- C. The parts covered by this specification document are subject to Mini-Circuits standard limited warranty and terms and conditions (collectively, "Standard Terms"); Purchasers of this part are entitled to the rights and benefits contained therein. For a full statement of the standard. Terms and the exclusive rights and remedies thereunder, please visit Mini-Circuits' website at www.minicircuits.com/terms/viewterm.html

2 Way-0° Power Splitter/Combiner

TCP-2-152-75X+

Typical Performance Data

FREQUENCY (MHz)	TOTAL LOSS ¹ (dB)		AMPLITUDE UNBALANCE (dB)	ISOLATION (dB)	PHASE UNBALANCE (deg.)	FREQUENCY (MHz)	VSWR (:1)		
	S-1	S-2					S	1	2
2	3.64	3.33	0.31	21.91	1.46	2	1.13	1.55	1.43
3	3.55	3.28	0.26	24.12	1.16	3	1.10	1.44	1.35
4	3.49	3.26	0.24	25.82	0.95	4	1.09	1.38	1.30
5	3.46	3.24	0.22	27.24	0.82	5	1.08	1.34	1.27
6	3.44	3.23	0.21	28.46	0.70	6	1.07	1.32	1.25
7	3.43	3.23	0.20	29.51	0.61	7	1.07	1.30	1.24
8	3.41	3.22	0.19	30.42	0.52	8	1.07	1.29	1.23
9	3.41	3.22	0.19	31.24	0.46	9	1.07	1.28	1.22
10	3.41	3.22	0.19	31.91	0.40	10	1.07	1.27	1.22
20	3.40	3.22	0.18	35.02	0.15	20	1.06	1.25	1.20
30	3.41	3.23	0.18	35.42	0.05	30	1.06	1.25	1.20
40	3.42	3.23	0.19	35.28	0.01	40	1.06	1.25	1.20
50	3.42	3.24	0.19	35.10	0.05	50	1.06	1.25	1.20
60	3.43	3.24	0.19	34.95	0.08	60	1.06	1.25	1.20
70	3.43	3.24	0.19	34.84	0.11	70	1.07	1.25	1.20
80	3.43	3.25	0.19	34.72	0.14	80	1.07	1.25	1.20
90	3.44	3.25	0.19	34.65	0.16	90	1.07	1.24	1.20
100	3.44	3.25	0.19	34.55	0.19	100	1.07	1.24	1.20
125	3.45	3.26	0.18	34.32	0.25	125	1.07	1.24	1.20
150	3.45	3.27	0.19	34.13	0.30	150	1.07	1.23	1.20
175	3.46	3.27	0.19	33.96	0.35	175	1.08	1.23	1.19
200	3.46	3.28	0.18	33.83	0.39	200	1.08	1.23	1.18
225	3.47	3.28	0.19	33.74	0.44	225	1.09	1.22	1.18
250	3.47	3.29	0.18	33.58	0.48	250	1.09	1.22	1.18
275	3.48	3.29	0.18	33.47	0.52	275	1.09	1.21	1.18
300	3.48	3.30	0.18	33.30	0.56	300	1.10	1.21	1.17
325	3.48	3.30	0.18	33.27	0.60	325	1.10	1.20	1.17
350	3.49	3.31	0.18	33.26	0.63	350	1.10	1.20	1.17
375	3.49	3.32	0.17	33.23	0.68	375	1.11	1.19	1.17
400	3.49	3.32	0.17	33.19	0.71	400	1.11	1.18	1.16
425	3.50	3.33	0.17	33.19	0.72	425	1.12	1.17	1.16
450	3.50	3.34	0.16	33.23	0.75	450	1.12	1.17	1.16
475	3.51	3.35	0.16	33.34	0.79	475	1.13	1.17	1.16
500	3.51	3.36	0.15	33.41	0.80	500	1.13	1.16	1.16
525	3.52	3.37	0.15	33.47	0.82	525	1.13	1.15	1.15
550	3.52	3.38	0.14	33.49	0.85	550	1.13	1.14	1.15
575	3.53	3.39	0.14	33.54	0.87	575	1.14	1.14	1.15
600	3.53	3.40	0.13	33.62	0.90	600	1.14	1.13	1.15
625	3.53	3.41	0.12	33.74	0.93	625	1.14	1.12	1.15
650	3.54	3.42	0.12	33.87	0.94	650	1.15	1.11	1.15
675	3.54	3.43	0.11	34.02	0.96	675	1.15	1.11	1.15
700	3.55	3.45	0.10	34.18	0.99	700	1.15	1.10	1.15
750	3.57	3.48	0.09	34.64	1.02	750	1.16	1.09	1.16
800	3.58	3.51	0.07	35.21	1.03	800	1.16	1.08	1.16
850	3.60	3.55	0.05	35.96	1.03	850	1.16	1.08	1.16
900	3.63	3.59	0.04	36.95	1.06	900	1.16	1.08	1.17
950	3.65	3.63	0.02	38.27	1.07	950	1.16	1.10	1.18
1000	3.68	3.68	0.01	39.83	1.09	1000	1.16	1.12	1.19
1050	3.72	3.73	0.01	41.38	1.12	1050	1.15	1.15	1.20
1100	3.75	3.78	0.03	41.55	1.14	1100	1.15	1.17	1.21
1150	3.79	3.84	0.05	39.72	1.17	1150	1.15	1.19	1.23
1218	3.84	3.93	0.08	35.73	1.18	1218	1.15	1.23	1.24
1250	3.88	3.97	0.10	33.87	1.19	1250	1.16	1.24	1.25
1300	3.93	4.05	0.11	31.26	1.21	1300	1.16	1.28	1.27
1350	4.01	4.13	0.12	28.94	1.24	1350	1.17	1.30	1.28
1400	4.08	4.21	0.13	26.85	1.30	1400	1.17	1.33	1.29
1450	4.17	4.31	0.14	24.92	1.39	1450	1.19	1.36	1.31
1500	4.27	4.41	0.14	23.17	1.56	1500	1.20	1.38	1.32

¹Total Loss = Insertion Loss + 3dB Splitter Loss



2 Way-0° Power Splitter/Combiner

TCP-2-152-75X+

Typical Performance Curves

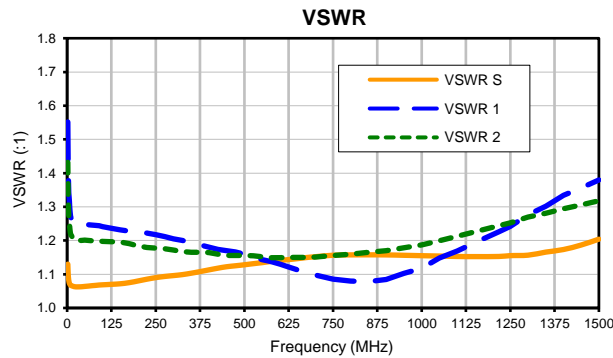
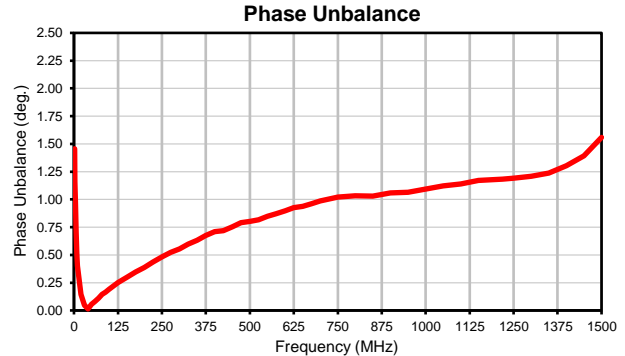
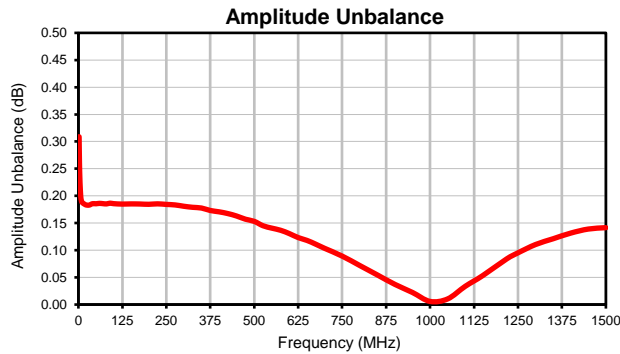
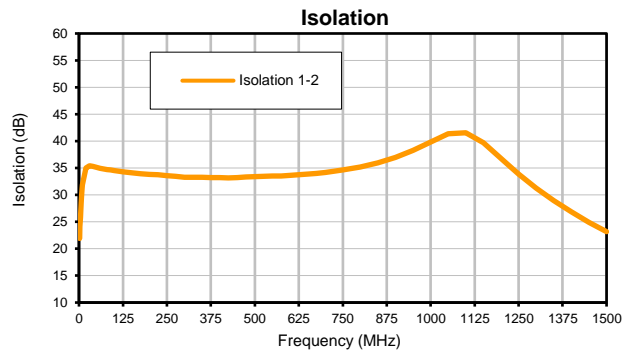
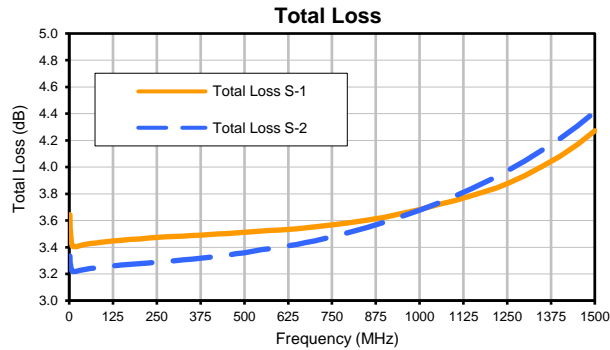

Outline Dimensions

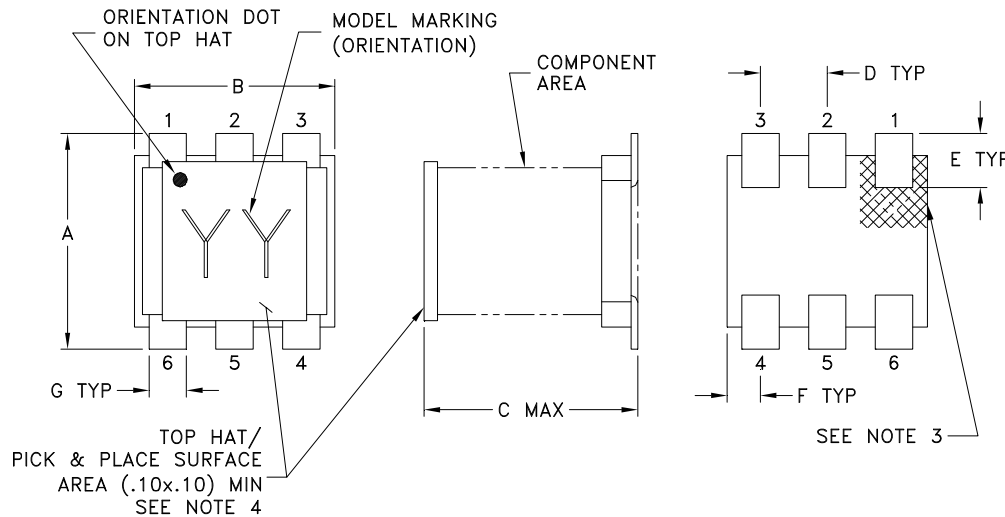

PCB Land Pattern

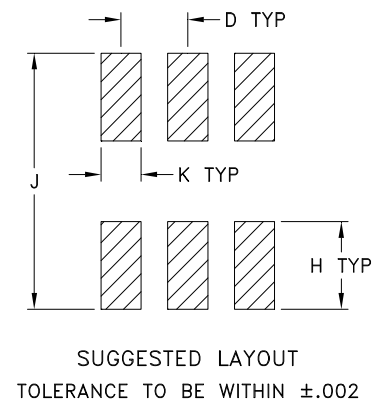

CASE #	A	B	C	D	E	F	G	H	J	K	WT. GRAM
DB1627	.160 (4.06)	.150 (3.81)	.160 (4.06)	.050 (1.27)	.040 (1.02)	.025 (0.64)	.028 (0.71)	.065 (1.65)	.190 (4.83)	.030 (0.76)	.15

Dimensions are in inches (mm). Tolerances: 2 Pl. $\pm .01$; 3Pl. $\pm .005$

Notes:

- Case material: Plastic.
- Termination finish:
For RoHS Case Styles: Tin plate over Nickel plate. All models, (+) suffix.
For RoHS-5 Case Styles: Tin-Lead plate. All models, no (+) suffix.
- Orientation dot on top hat & orientation feature on substrate correspondence to pin #1.
- Top-Hat total thickness: .013 inches MAX.

Tape & Reel Packaging TR-F47

DEVICE ORIENTATION IN T&R

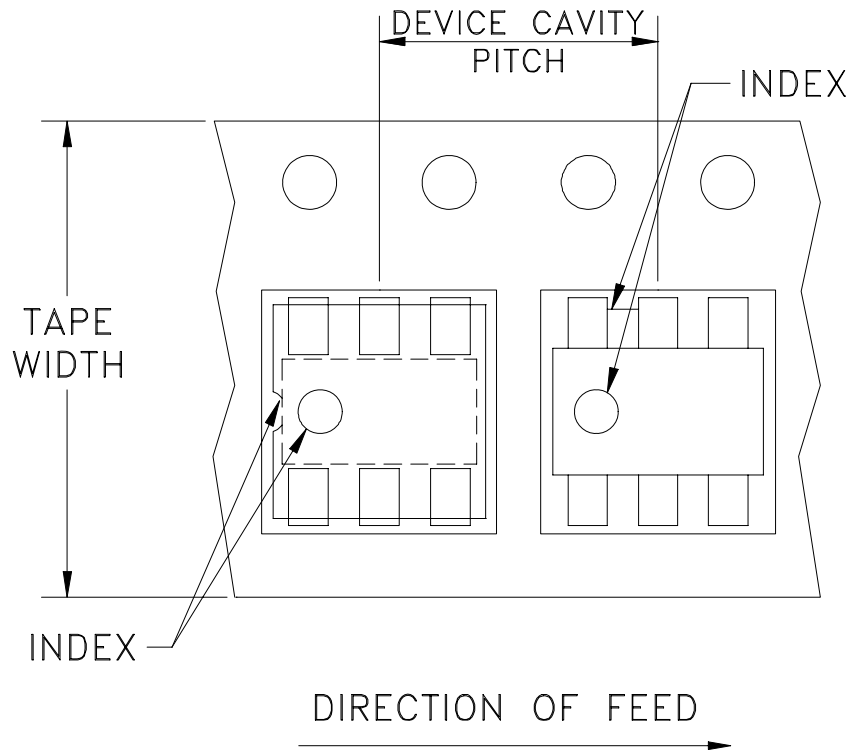

Tape Width, mm	Device Cavity Pitch, mm	Reel Size, inches	Devices per Reel see note
12	8	13	1000, 2000
		7	20, 50, 100, 200, 500

Note: Please consult individual model data sheet to determine device per reel availability.

Mini-Circuits carrier tape materials provide protection from ESD (Electro-Static Discharge) during handling and transportation. Tapes are static dissipative and comply with industry standards EIA-481/EIA-541.

Go to: www.minicircuits.com/pages/pdfs/tape.pdf

Mini-Circuits®

INTERNET <http://www.minicircuits.com>

P.O. Box 350166, Brooklyn, New York 11235-0003 (718) 934-4500 Fax (718) 332-4661

Distribution Centers NORTH AMERICA 800-654-7949 • 417-335-5935 • Fax 417-335-5945 • EUROPE 44-1252-832600 • Fax 44-1252-837010

Mini-Circuits ISO 9001 & ISO 14001 Certified

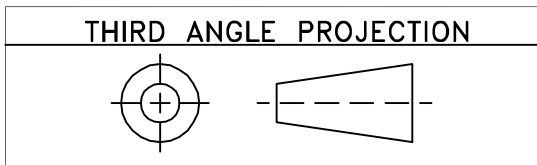

REVISIONS					
REV	ECN No.	DESCRIPTION	DATE	DR	AUTH
OR	M153610	NEW RELEASE	11/13/15	GF	JC

**SUGGESTED MOUNTING CONFIGURATION
FOR DB1627 CASE STYLE, "06SP15" PIN CODE**

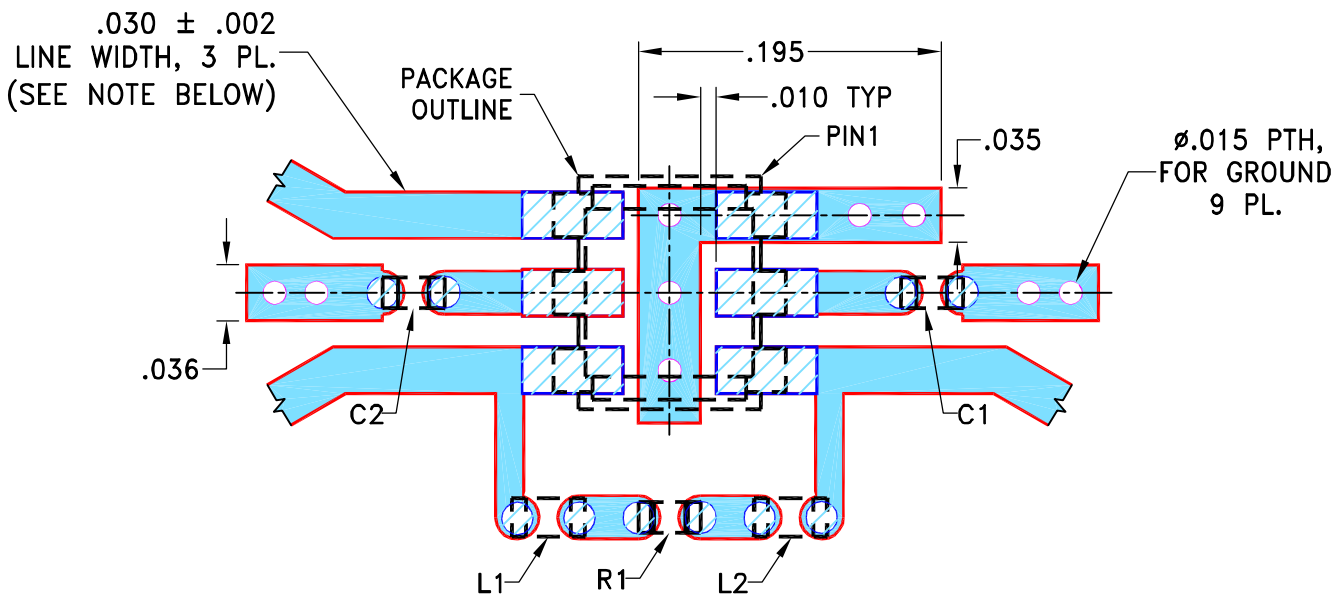

COMPONENT	SIZE
L1, L2	0402
C1,C2	0402
R1	0402

NOTES:

- TRACE WIDTH PARAMETERS ARE SHOWN FOR ROGERS R04350B WITH DIELECTRIC THICKNESS $.030 \pm .002$ ". COPPER: 1/2 OZ. EACH SIDE. FOR OTHER MATERIALS TRACE WIDTH AND GAP MAY NEED TO BE MODIFIED.
- BOTTOM SIDE OF THE PCB IS CONTINUOUS GROUND PLANE.

- DENOTES PCB COPPER LAYOUT WITH SMOBC (SOLDER MASK OVER BARE COPPER).
- DENOTES COPPER LAND PATTERN FREE OF SOLDER MASK.

UNLESS OTHERWISE SPECIFIED	INITIALS	DATE
DIMENSIONS ARE IN INCHES	DRAWN GF	10/30/15
TOLERANCES ON:	CHECKED IL	11/12/15
2 PL DECIMALS ±	APPROVED JC	11/13/15
3 PL DECIMALS ± .005		
ANGLES ±		
FRACTIONS ±		

Mini-Circuits® 13 Neptune Avenue
Brooklyn NY 11235

PL, 06SP15, DB1627, TB-835+

Mini-Circuits®
 THIS DOCUMENT AND ITS CONTENTS ARE THE PROPERTY OF MINI-CIRCUITS. EXCEPT FOR USE EXPRESSLY GRANTED, IN WRITING, TO ITS VENDORS, VENDEE AND THE UNITED STATES GOVERNMENT, MINI-CIRCUITS RESERVES ALL PROPRIETARY DESIGN, USE, MANUFACTURING AND REPRODUCTION RIGHTS THERETO. THESE CONTENTS SHALL NOT BE USED, DUPLICATED OR DISCLOSED TO ANY OUTSIDE PARTY, IN WHOLE OR IN PART, WITHOUT WRITTEN PERMISSION OF MINI-CIRCUITS.

SIZE A	CODE IDENT 15542	DRAWING NO: 98-PL-457	REV: OR
FILE: 98PL457	SCALE: 8:1	SHEET: 1 OF 1	

Evaluation Board and Circuit

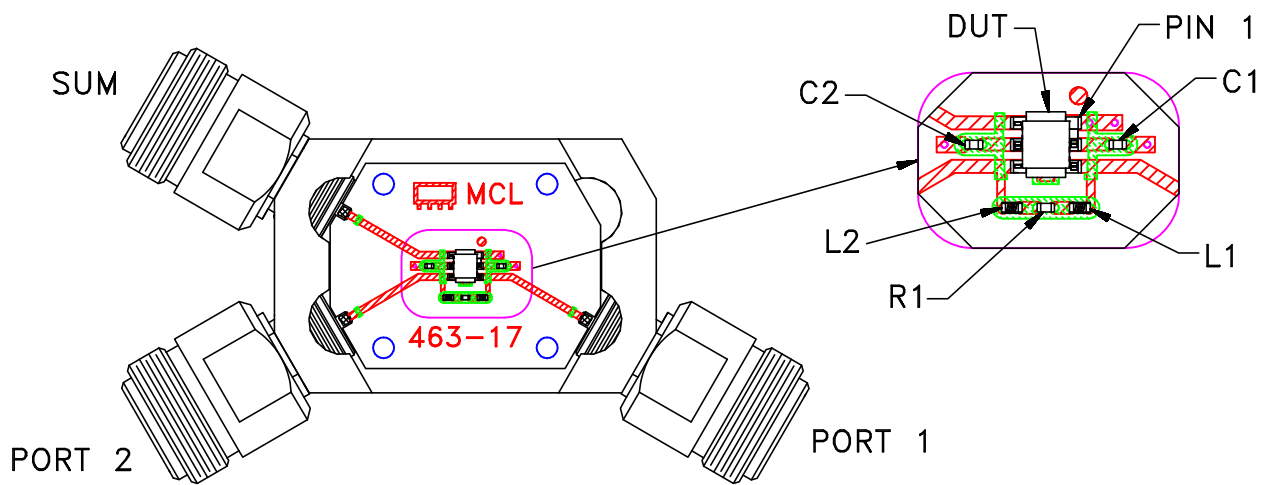

TB-835+

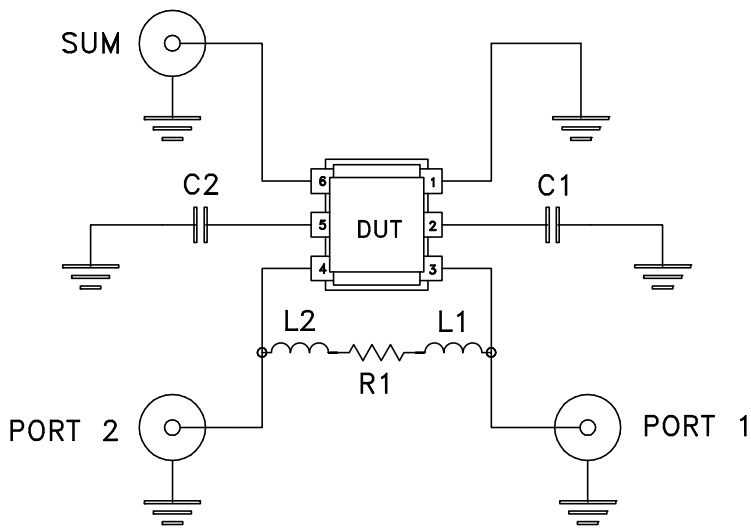

ITEM	DESCRIPTION	SIZE
DUT	TCP-2-10-75-13+	-
C1	CAP, 1.0 pF	0402
C2	CAP, 1.2 pF	
L1,L2	IND, 2.7 nH	
R1	RES, 150 Ohm	

Schematic Diagram

Notes:

1. 75 Ohm N-type Female connectors.
2. PCB Material: R04350 or equivalent,
Dielectric Constant=3.5, Thickness=.030 inch.

 **Mini-Circuits®**

All Mini-Circuits products are manufactured under exacting quality assurance and control standards, and are capable of meeting published specifications after being subjected to any or all of the following physical and environmental test.

Specification	Test/Inspection Condition	Reference/Spec
Operating Temperature	-40° to 85°C Ambient Environment	Individual Model Data Sheet
Storage Temperature	-55° to 100° C Ambient Environment	Individual Model Data Sheet
Humidity	90 to 95% RH, 240 hours, 50°C	MIL-STD-202, Method 103, Condition A, Except 50°C and end-point electrical test done within 12 hours
Thermal Shock	-55° to 100°C, 100 cycles	MIL-STD-202, Method 107, Condition A-3, except +100°C
Solder Reflow Heat	Sn-Pb Eutetic Process: 225°C peak Pb-Free Process 245° - 250°C peak	J-STD-020, Table 4-1, 4-2 and 5-2, Figure 5-1
Solderability	10X Magnification	J-STD-002, 95% Coverage
Vibration (High Frequency)	20g peak, 10-2000 Hz, 12 times in each of three perpendicular directions (total 36)	MIL-STD-202, Method 204, Condition D
Mechanical Shock	50g, 11 ms, 1/2-sine, 18 shocks: 3 each direction, each of 3 axes	MIL-STD-202, Method 213, Condition A
Marking Resistance to Solvents	Isopropyl alcohol + mineral spirits at 25°C; terpene defluxer at 25°C; distilled water + proylene glycol monomethyl ether + monoethanolamine at 63°C to 70°C	MIL-STD-202, Method 215