



**SURFACE MOUNT**

# Power Splitter/Combiner **TCP-2-10-75X+**

Mini-Circuits

75Ω    2 Way-0°    5 to 1000 MHz

## FEATURES

- Low insertion, 0.3 dB typ.
- Excellent amplitude unbalance, 0.2 dB typ.
- Very good phase unbalance, 1.0 deg. typ.
- External resistor & capacitor required
- Aqueous washable
- Leads for excellent solderability
- Low cost



Generic photo used for illustration purposes only

CASE STYLE: DB1627

### +RoHS Compliant

The +Suffix identifies RoHS Compliance. See our web site for RoHS Compliance methodologies and qualifications

## APPLICATIONS

- CATV
- Cellular

## ELECTRICAL SPECIFICATIONS AT 25°C

Parameter	Frequency (MHz)	Min.	Typ.	Max.	Unit
Frequency Range		5		1000	MHz
Insertion Loss, above 3.0 dB	5 - 50	—	0.3	1.4	dB
	50 - 500	—	0.3	0.9	
	500 - 1000	—	0.6	1.3	
Isolation	5 - 50	14	24	—	dB
	50 - 500	19	29	—	
	500 - 1000	16	30	—	
Phase Unbalance	5 - 50	—	—	6.0	Degree
	50 - 500	—	—	4.0	
	500 - 1000	—	—	3.0	
Amplitude Unbalance	5 - 50	—	—	1.2	dB
	50 - 500	—	—	0.6	
	500 - 1000	—	—	0.5	

## MAXIMUM RATINGS

Parameter	Ratings
Operating temperature	-40°C to 85°C
Storage temperature	-55°C to 100°C
RF Power Input (as splitter)	0.5 W max.

Permanent damage may occur if any of these limits are exceeded.

## FUNCTIONAL SCHEMATIC

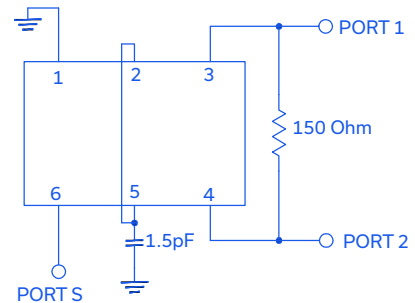

REV. C  
ECO-018059  
TCP-2-10-75X+  
DY/TD/CP/AM  
230605





## SURFACE MOUNT

# Power Splitter/Combiner TCP-2-10-75X+

### PIN CONNECTIONS

SUM PORT	6
PORT 1	3
PORT 2	4
GROUND	1
CONNECT	2,5
EXT. RESISTOR 150Ω	3,4
EXT. CAPACITOR 1.5pF	2 OR 5 TO GND

### PRODUCT MARKING: PB

### DEMO BOARD MCL P/N: TB-124 SUGGESTED PCB LAYOUT (PL-002)

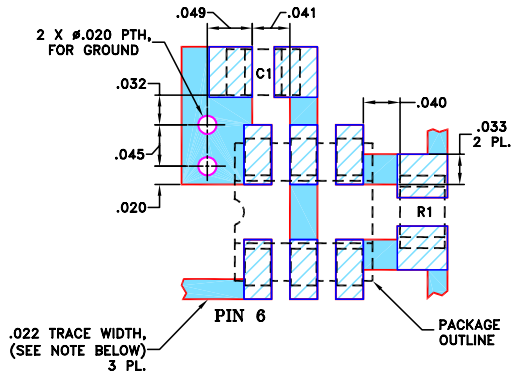

RESISTOR R1: 150 Ohm, 0805 SIZE  
CAPACITOR C1: 1.5 pF, 0805 SIZE

NOTES: 1. TRACE WIDTH IS SHOWN FOR ROGERS R04350B WITH DIELECTRIC THICKNESS  $0.030 \pm 0.002$ ”; COPPER: 1 OZ. EACH SIDE. FOR OTHER MATERIALS TRACE WIDTH MAY NEED TO BE MODIFIED.

2. BOTTOM SIDE OF THE PCB IS CONTINUOUS GROUND PLANE.
- DENOTES PCB COPPER LAYOUT WITH SMOBC (SOLDER MASK OVER BARE COPPER)
  - DENOTES COPPER LAND PATTERN FREE OF SOLDER MASK

### OUTLINE DRAWING

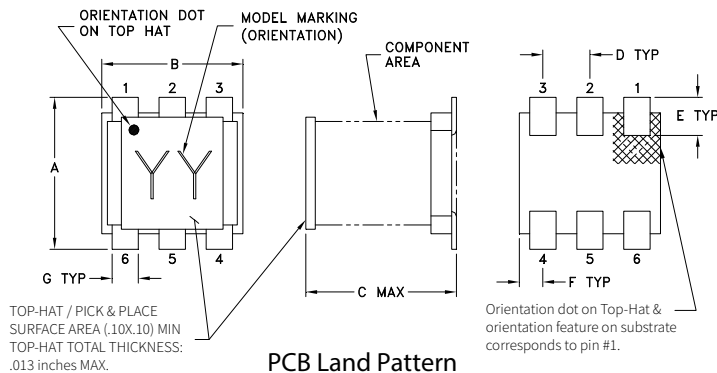

### PCB Land Pattern

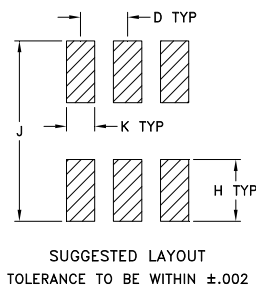

### OUTLINE DIMENSIONS (Inches mm)

A	B	C	D	E	F
.160	.150	.160	.050	.040	.025
4.06	3.81	4.06	1.27	1.02	0.64
G	H	J	K		wt
.028	.065	.190	.030		grams
0.71	1.65	4.83	0.76		0.15

### TAPE & REEL INFORMATION: F47



# SURFACE MOUNT

# Power Splitter/Combiner TCP-2-10-75X+

Mini-Circuits

### TYPICAL PERFORMANCE DATA AT 25°C

Frequency (MHz)	Total Loss <sup>1</sup> (dB)		Amplitude Unbalance (dB)	Isolation (dB)	Phase Unbalance (deg.)	VSWR (:1)		
	S-1	S-2				S	1	2
5.00	3.14	3.32	0.19	27.67	0.39	1.02	1.16	1.21
8.00	3.13	3.31	0.18	28.39	0.22	1.01	1.15	1.19
10.00	3.13	3.32	0.18	28.59	0.14	1.01	1.14	1.19
20.00	3.14	3.32	0.18	28.82	0.06	1.00	1.14	1.18
35.00	3.14	3.32	0.19	28.77	0.04	1.00	1.14	1.18
50.00	3.14	3.33	0.18	28.68	0.01	1.00	1.14	1.18
80.00	3.15	3.33	0.18	28.61	0.08	1.01	1.13	1.17
110.00	3.16	3.34	0.18	28.60	0.16	1.02	1.13	1.17
150.00	3.17	3.35	0.18	28.65	0.12	1.03	1.12	1.16
350.00	3.21	3.39	0.18	28.62	0.20	1.10	1.11	1.10
550.00	3.25	3.40	0.15	26.72	0.34	1.21	1.17	1.13
650.00	3.27	3.41	0.14	25.16	0.31	1.27	1.23	1.19
750.00	3.34	3.47	0.13	23.56	0.39	1.33	1.30	1.26
900.00	3.54	3.65	0.11	21.40	0.55	1.40	1.41	1.36
1000.00	3.71	3.80	0.09	20.18	0.68	1.44	1.48	1.42

1. Total Loss = Insertion Loss + 3dB splitter loss.

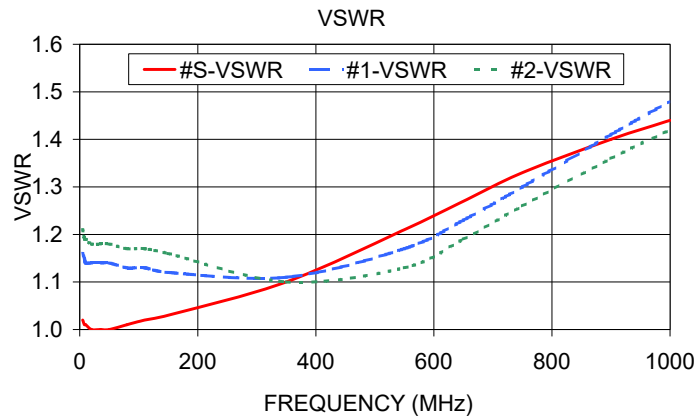
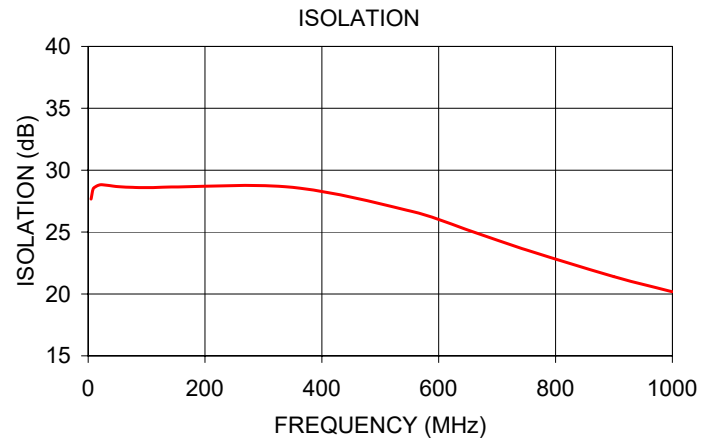
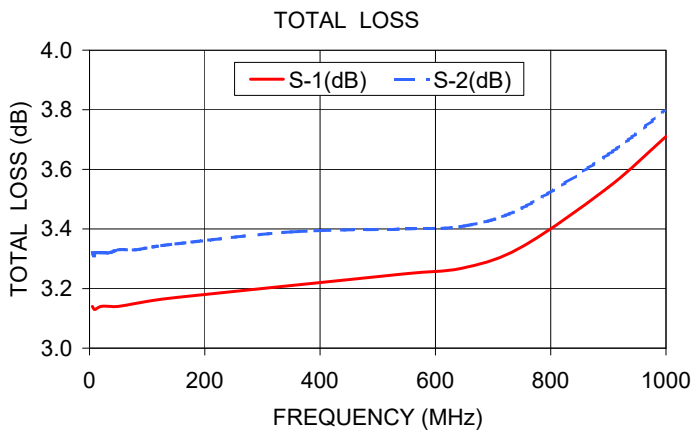

#### NOTES

- A. Performance and quality attributes and conditions not expressly stated in this specification document are intended to be excluded and do not form a part of this specification document.
- B. Electrical specifications and performance data contained in this specification document are based on Mini-Circuit's applicable established test performance criteria and measurement instructions.
- C. The parts covered by this specification document are subject to Mini-Circuits standard limited warranty and terms and conditions (collectively, "Standard Terms"); Purchasers of this part are entitled to the rights and benefits contained therein. For a full statement of the standard. Terms and the exclusive rights and remedies thereunder, please visit Mini-Circuits' website at [www.minicircuits.com/MCLStore/terms.jsp](http://www.minicircuits.com/MCLStore/terms.jsp)



# 2 Way-0° Power Splitter/Combiner

# TCP-2-10-75X+

## Typical Performance Data

TEST CONDITIONS: INPUT POWER =0 dBm @Temperature = +25°C

FREQUENCY (MHz)	TOTAL LOSS <sup>1</sup> (dB)		AMPLITUDE UNBALANCE (dB)	ISOLATION (dB) 1-2	PHASE UNBALANCE (Deg)	FREQUENCY (MHz)	VSWR (:1)		
	S-1	S-2					S	1	2
5.0	3.37	3.15	0.22	26.42	0.50	5.0	1.04	1.24	1.18
10.0	3.35	3.14	0.21	28.02	0.28	10.0	1.02	1.21	1.16
25.0	3.36	3.15	0.21	28.75	0.06	25.0	1.00	1.19	1.14
50.0	3.37	3.17	0.20	28.66	0.01	50.0	1.02	1.19	1.14
75.0	3.39	3.19	0.20	28.57	0.04	75.0	1.03	1.19	1.14
100.0	3.40	3.19	0.21	28.62	0.05	100.0	1.04	1.19	1.14
150.0	3.42	3.21	0.21	28.73	0.12	150.0	1.07	1.18	1.15
200.0	3.43	3.23	0.20	28.96	0.16	200.0	1.09	1.18	1.16
250.0	3.44	3.25	0.19	29.24	0.21	250.0	1.11	1.18	1.18
300.0	3.46	3.28	0.18	29.33	0.28	300.0	1.13	1.18	1.19
350.0	3.47	3.30	0.17	29.37	0.32	350.0	1.15	1.18	1.20
400.0	3.48	3.33	0.15	29.31	0.36	400.0	1.16	1.18	1.22
425.0	3.50	3.34	0.16	28.92	0.33	425.0	1.17	1.18	1.22
450.0	3.50	3.36	0.14	29.00	0.37	450.0	1.18	1.18	1.23
475.0	3.52	3.36	0.16	28.55	0.37	475.0	1.18	1.18	1.23
500.0	3.52	3.39	0.13	28.66	0.37	500.0	1.18	1.18	1.24
525.0	3.53	3.39	0.14	28.05	0.44	525.0	1.18	1.17	1.24
550.0	3.54	3.41	0.13	28.09	0.37	550.0	1.19	1.17	1.24
575.0	3.55	3.42	0.13	27.49	0.48	575.0	1.19	1.17	1.24
600.0	3.56	3.44	0.12	27.24	0.36	600.0	1.18	1.17	1.25
650.0	3.58	3.47	0.11	26.43	0.32	650.0	1.18	1.17	1.25
700.0	3.60	3.50	0.10	25.47	0.35	700.0	1.18	1.16	1.25
750.0	3.62	3.53	0.10	24.36	0.38	750.0	1.17	1.16	1.24
800.0	3.64	3.56	0.08	23.25	0.40	800.0	1.16	1.16	1.24
850.0	3.66	3.59	0.07	22.13	0.39	850.0	1.16	1.15	1.24
900.0	3.68	3.62	0.06	21.16	0.31	900.0	1.16	1.15	1.23
925.0	3.71	3.64	0.06	20.88	0.08	925.0	1.16	1.15	1.23
950.0	3.71	3.65	0.06	20.46	0.20	950.0	1.16	1.15	1.22
975.0	3.74	3.68	0.06	19.96	0.02	975.0	1.16	1.16	1.22
1000.0	3.74	3.69	0.05	19.70	0.05	1000.0	1.16	1.16	1.22
1025.0	3.77	3.70	0.07	19.35	0.21	1025.0	1.17	1.16	1.22
1050.0	3.77	3.73	0.04	19.01	0.32	1050.0	1.17	1.16	1.22
1075.0	3.80	3.75	0.05	18.90	0.46	1075.0	1.18	1.17	1.22
1100.0	3.81	3.78	0.03	18.50	0.62	1100.0	1.18	1.17	1.22
1150.0	3.86	3.84	0.02	18.15	0.99	1150.0	1.20	1.18	1.23
1200.0	3.92	3.92	0.01	18.04	1.38	1200.0	1.23	1.18	1.23
1250.0	3.99	4.01	0.02	18.14	1.86	1250.0	1.26	1.19	1.25
1300.0	4.09	4.12	0.03	18.21	2.35	1300.0	1.30	1.20	1.26
1350.0	4.22	4.26	0.04	18.15	2.80	1350.0	1.35	1.20	1.28
1400.0	4.37	4.45	0.08	17.77	3.26	1400.0	1.42	1.21	1.31
1450.0	4.56	4.68	0.12	16.81	3.72	1450.0	1.51	1.21	1.34
1500.0	4.81	4.95	0.14	15.58	4.11	1500.0	1.62	1.21	1.37
1600.0	5.42	5.61	0.18	12.94	4.81	1600.0	1.89	1.20	1.44
1700.0	6.13	6.23	0.10	10.90	5.86	1700.0	2.21	1.16	1.48

<sup>1</sup>Total Loss = Insertion Loss + 3dB Splitter Loss



# 2 Way-0° Power Splitter/Combiner

# TCP-2-10-75X+

## Typical Performance Data

TEST CONDITIONS: INPUT POWER =0 dBm @Temperature = -40°C

FREQUENCY (MHz)	TOTAL LOSS <sup>1</sup> (dB)		AMPLITUDE UNBALANCE (dB)	ISOLATION (dB) 1-2	PHASE UNBALANCE (Deg)	FREQUENCY (MHz)	VSWR (:1)		
	S-1	S-2					S	1	2
5.0	3.39	3.17	0.22	22.93	1.72	5.0	1.06	1.34	1.24
10.0	3.30	3.15	0.16	26.38	1.06	10.0	1.03	1.23	1.17
25.0	3.26	3.13	0.13	30.14	0.35	25.0	1.02	1.16	1.11
50.0	3.26	3.14	0.12	31.29	0.20	50.0	1.05	1.14	1.09
75.0	3.27	3.15	0.12	31.42	0.18	75.0	1.05	1.13	1.08
100.0	3.28	3.15	0.13	31.47	0.20	100.0	1.03	1.13	1.10
150.0	3.29	3.16	0.13	31.59	0.22	150.0	1.06	1.12	1.12
200.0	3.30	3.17	0.13	31.64	0.30	200.0	1.06	1.13	1.11
250.0	3.31	3.19	0.12	31.66	0.36	250.0	1.08	1.14	1.15
300.0	3.32	3.21	0.11	31.39	0.41	300.0	1.11	1.15	1.17
350.0	3.33	3.22	0.11	30.95	0.51	350.0	1.13	1.17	1.19
400.0	3.34	3.24	0.10	30.50	0.59	400.0	1.16	1.18	1.21
425.0	3.35	3.25	0.10	29.91	0.68	425.0	1.17	1.19	1.22
450.0	3.35	3.27	0.08	29.77	0.71	450.0	1.18	1.19	1.23
475.0	3.37	3.27	0.10	29.12	0.76	475.0	1.19	1.20	1.25
500.0	3.36	3.30	0.06	29.14	0.84	500.0	1.20	1.20	1.25
525.0	3.37	3.29	0.08	28.26	0.83	525.0	1.20	1.20	1.25
550.0	3.38	3.31	0.07	28.23	0.96	550.0	1.21	1.20	1.26
575.0	3.39	3.32	0.07	27.43	0.92	575.0	1.21	1.20	1.27
600.0	3.39	3.34	0.05	27.09	1.12	600.0	1.22	1.21	1.28
650.0	3.41	3.36	0.05	26.02	1.25	650.0	1.22	1.21	1.27
700.0	3.43	3.39	0.04	24.87	1.30	700.0	1.22	1.20	1.28
750.0	3.44	3.42	0.02	23.59	1.41	750.0	1.22	1.20	1.27
800.0	3.45	3.44	0.01	22.42	1.45	800.0	1.21	1.19	1.24
850.0	3.46	3.46	0.00	21.19	1.58	850.0	1.20	1.18	1.24
900.0	3.47	3.50	0.03	20.21	1.71	900.0	1.18	1.17	1.22
925.0	3.49	3.51	0.02	19.94	2.06	925.0	1.17	1.17	1.21
950.0	3.49	3.53	0.04	19.51	2.02	950.0	1.16	1.16	1.20
975.0	3.51	3.54	0.02	19.03	2.27	975.0	1.15	1.16	1.19
1000.0	3.52	3.55	0.03	18.79	2.34	1000.0	1.14	1.15	1.18
1025.0	3.54	3.56	0.02	18.44	2.56	1025.0	1.13	1.15	1.17
1050.0	3.55	3.59	0.04	18.18	2.77	1050.0	1.13	1.14	1.16
1075.0	3.57	3.61	0.04	18.06	2.91	1075.0	1.12	1.14	1.16
1100.0	3.58	3.63	0.05	17.74	3.16	1100.0	1.12	1.14	1.16
1150.0	3.63	3.71	0.08	17.46	3.63	1150.0	1.11	1.14	1.17
1200.0	3.68	3.79	0.12	17.44	4.18	1200.0	1.12	1.15	1.20
1250.0	3.73	3.86	0.13	17.71	4.76	1250.0	1.14	1.15	1.25
1300.0	3.82	3.95	0.13	17.94	5.31	1300.0	1.21	1.16	1.27
1350.0	3.92	4.07	0.15	18.06	5.94	1350.0	1.32	1.18	1.35
1400.0	4.06	4.25	0.19	17.81	6.56	1400.0	1.44	1.21	1.42
1450.0	4.22	4.55	0.33	16.93	7.15	1450.0	1.56	1.23	1.49
1500.0	4.45	4.76	0.31	15.63	7.69	1500.0	1.76	1.25	1.60
1600.0	5.07	5.35	0.27	12.83	8.42	1600.0	2.13	1.27	1.64
1700.0	5.78	6.00	0.22	10.62	9.62	1700.0	2.37	1.23	1.60

<sup>1</sup>Total Loss = Insertion Loss + 3dB Splitter Loss



# 2 Way-0° Power Splitter/Combiner

# TCP-2-10-75X+

## Typical Performance Data

TEST CONDITIONS: INPUT POWER =0 dBm @Temperature = +85°C

FREQUENCY (MHz)	TOTAL LOSS <sup>1</sup> (dB)		AMPLITUDE UNBALANCE (dB)	ISOLATION (dB) 1-2	PHASE UNBALANCE (Deg)	FREQUENCY (MHz)	VSWR (:1)		
	S-1	S-2					S	1	2
5.0	3.46	3.18	0.28	25.24	0.47	5.0	1.04	1.28	1.20
10.0	3.44	3.18	0.26	26.14	0.26	10.0	1.03	1.25	1.18
25.0	3.45	3.20	0.25	26.33	0.07	25.0	1.02	1.24	1.18
50.0	3.47	3.22	0.25	26.20	0.03	50.0	1.03	1.24	1.20
75.0	3.49	3.24	0.25	26.19	0.01	75.0	1.05	1.24	1.20
100.0	3.50	3.25	0.25	26.32	0.03	100.0	1.06	1.24	1.19
150.0	3.52	3.27	0.25	26.50	0.02	150.0	1.07	1.23	1.18
200.0	3.53	3.30	0.23	26.82	0.08	200.0	1.11	1.22	1.20
250.0	3.55	3.33	0.22	27.21	0.16	250.0	1.13	1.21	1.20
300.0	3.56	3.36	0.20	27.38	0.23	300.0	1.14	1.20	1.20
350.0	3.58	3.39	0.19	27.56	0.28	350.0	1.16	1.19	1.21
400.0	3.59	3.42	0.17	27.69	0.34	400.0	1.16	1.17	1.21
425.0	3.61	3.43	0.18	27.48	0.32	425.0	1.16	1.17	1.21
450.0	3.61	3.45	0.16	27.64	0.36	450.0	1.16	1.16	1.21
475.0	3.63	3.46	0.17	27.41	0.37	475.0	1.16	1.16	1.22
500.0	3.63	3.49	0.14	27.57	0.36	500.0	1.16	1.16	1.22
525.0	3.65	3.50	0.15	27.28	0.43	525.0	1.16	1.15	1.22
550.0	3.66	3.52	0.14	27.39	0.37	550.0	1.15	1.15	1.22
575.0	3.67	3.53	0.14	27.09	0.46	575.0	1.15	1.15	1.22
600.0	3.68	3.56	0.12	26.91	0.37	600.0	1.15	1.14	1.22
650.0	3.70	3.59	0.11	26.46	0.34	650.0	1.14	1.14	1.22
700.0	3.73	3.62	0.11	25.79	0.38	700.0	1.14	1.14	1.23
750.0	3.75	3.66	0.09	24.89	0.41	750.0	1.14	1.14	1.23
800.0	3.77	3.70	0.07	23.92	0.44	800.0	1.14	1.14	1.23
850.0	3.80	3.74	0.06	22.88	0.45	850.0	1.14	1.14	1.23
900.0	3.83	3.78	0.05	21.94	0.40	900.0	1.15	1.14	1.24
925.0	3.85	3.80	0.04	21.69	0.17	925.0	1.15	1.14	1.24
950.0	3.86	3.83	0.03	21.29	0.32	950.0	1.16	1.15	1.24
975.0	3.89	3.85	0.03	20.73	0.08	975.0	1.16	1.15	1.24
1000.0	3.90	3.87	0.03	20.49	0.08	1000.0	1.17	1.16	1.24
1025.0	3.92	3.89	0.03	20.11	0.09	1025.0	1.18	1.16	1.25
1050.0	3.93	3.93	0.00	19.76	0.19	1050.0	1.19	1.16	1.25
1075.0	3.96	3.95	0.01	19.67	0.30	1075.0	1.20	1.17	1.25
1100.0	3.98	3.98	0.00	19.22	0.44	1100.0	1.21	1.17	1.25
1150.0	4.04	4.06	0.02	18.85	0.76	1150.0	1.24	1.18	1.25
1200.0	4.10	4.15	0.06	18.71	1.15	1200.0	1.26	1.19	1.25
1250.0	4.17	4.26	0.09	18.82	1.59	1250.0	1.29	1.19	1.25
1300.0	4.28	4.39	0.11	18.90	1.94	1300.0	1.31	1.19	1.25
1350.0	4.42	4.53	0.12	18.85	2.40	1350.0	1.34	1.19	1.25
1400.0	4.56	4.72	0.16	18.52	2.85	1400.0	1.38	1.18	1.26
1450.0	4.75	4.96	0.21	17.62	3.31	1450.0	1.44	1.17	1.28
1500.0	4.98	5.23	0.25	16.42	3.68	1500.0	1.51	1.16	1.30
1600.0	5.57	5.87	0.30	13.80	4.38	1600.0	1.74	1.14	1.39
1700.0	6.23	6.50	0.27	11.73	5.33	1700.0	2.11	1.12	1.48

<sup>1</sup>Total Loss = Insertion Loss + 3dB Splitter Loss



# 2 Way-0° Power Splitter/Combiner

# TCP-2-10-75X+

## Typical Performance Curves

Total Loss

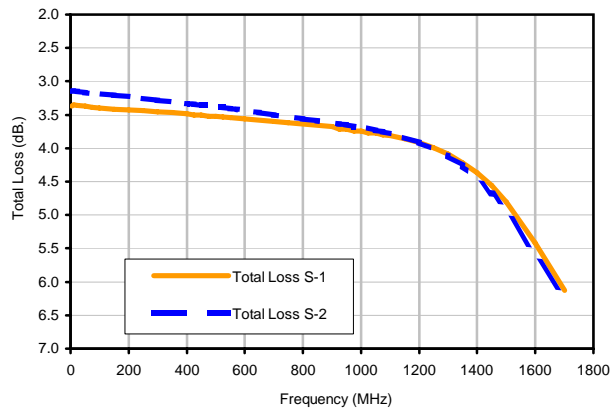

Total Loss S-1 vs. TEMPERATURE

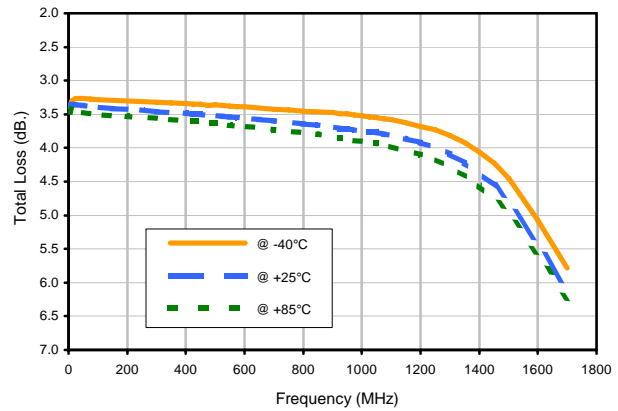

Amplitude Unbalance vs. TEMPERATURE

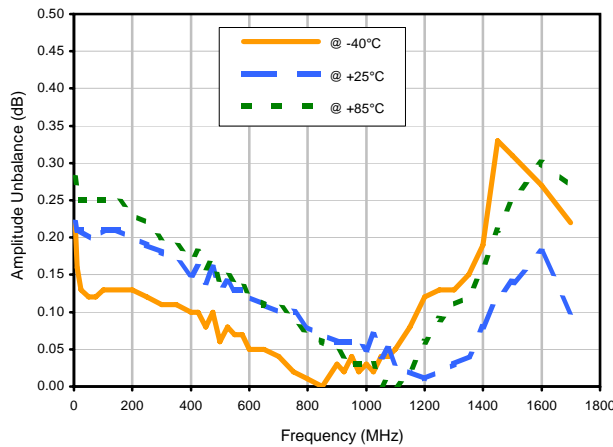

Phase Unbalance vs. TEMPERATURE

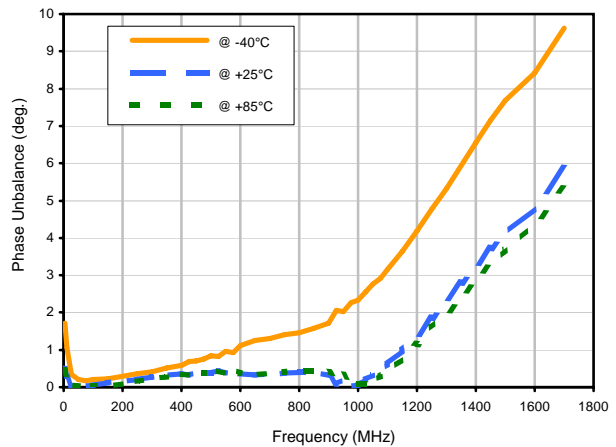

Isolation 1-2 vs. TEMPERATURE

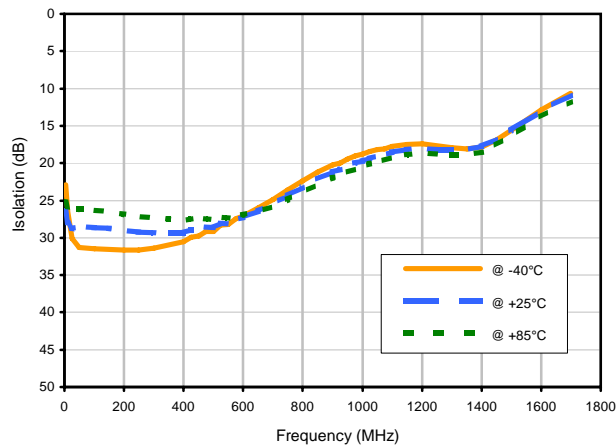

# 2 Way-0° Power Splitter/Combiner

# TCP-2-10-75X+

## Typical Performance Curves

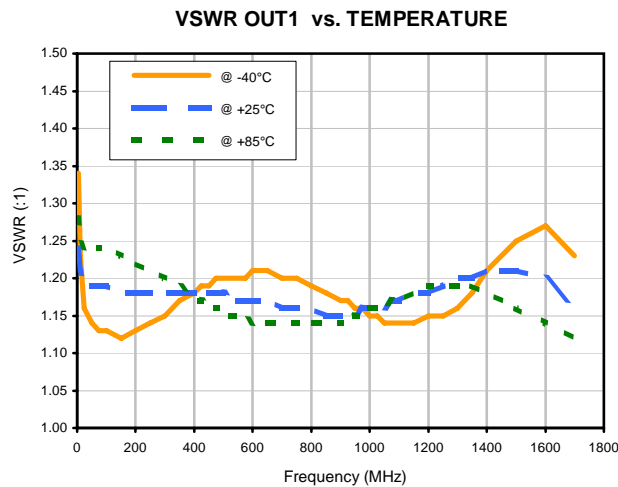
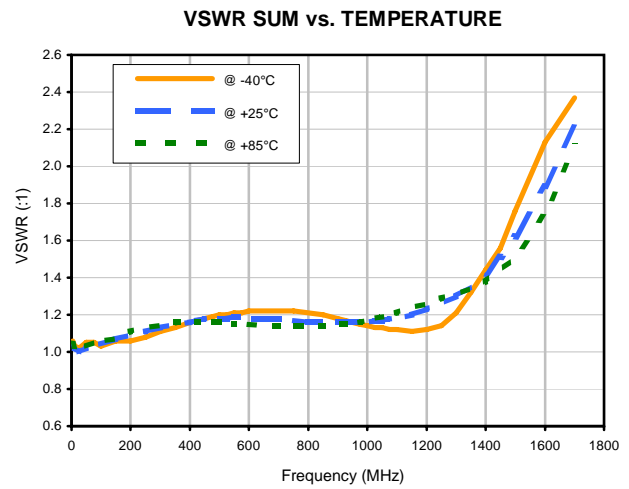
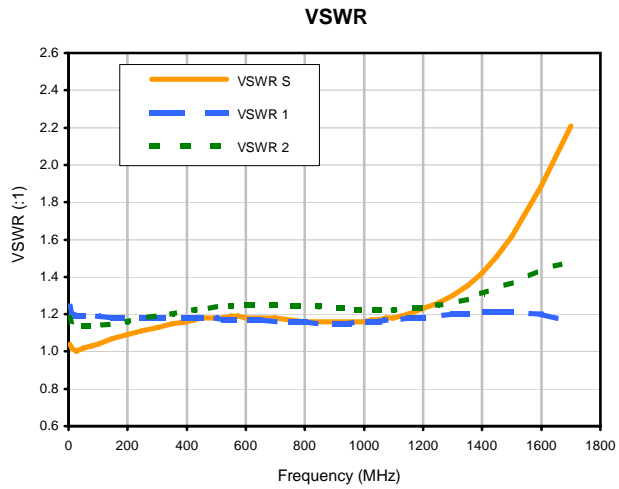



### Outline Dimensions

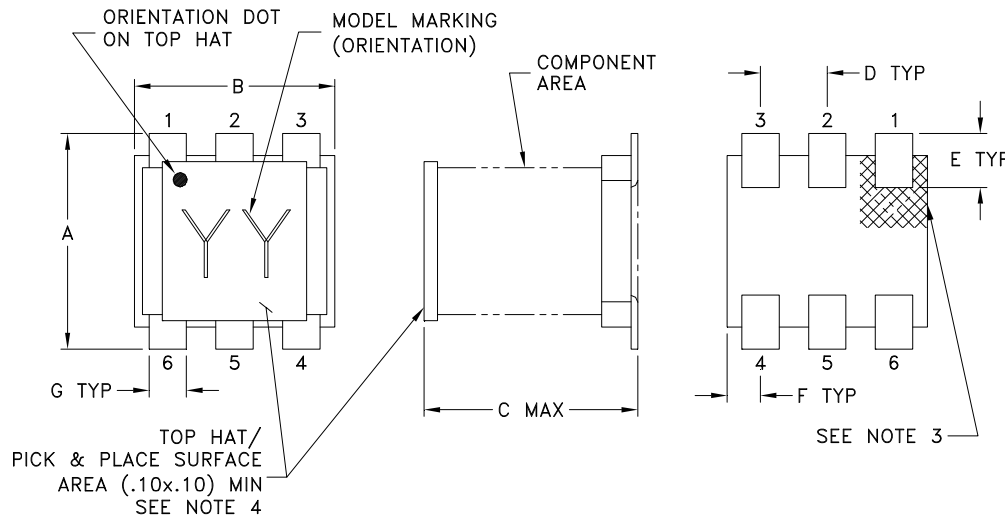

### PCB Land Pattern

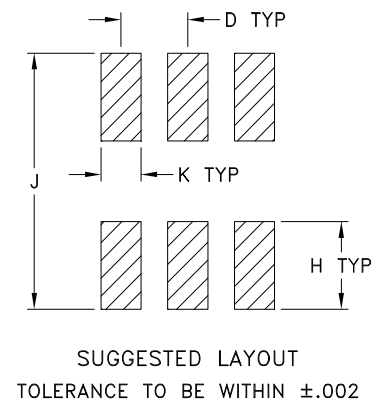

CASE #	A	B	C	D	E	F	G	H	J	K	WT. GRAM
DB1627	.160 (4.06)	.150 (3.81)	.160 (4.06)	.050 (1.27)	.040 (1.02)	.025 (0.64)	.028 (0.71)	.065 (1.65)	.190 (4.83)	.030 (0.76)	.15

Dimensions are in inches (mm). Tolerances: 2 Pl.  $\pm .01$ ; 3Pl.  $\pm .005$

### Notes:

- Case material: Plastic.
- Termination finish:  
For RoHS Case Styles: Tin plate over Nickel plate. All models, (+) suffix.  
For RoHS-5 Case Styles: Tin-Lead plate. All models, no (+) suffix.
- Orientation dot on top hat & orientation feature on substrate correspondence to pin #1.
- Top-Hat total thickness: .013 inches MAX.

# Tape & Reel Packaging TR-F47

## DEVICE ORIENTATION IN T&R

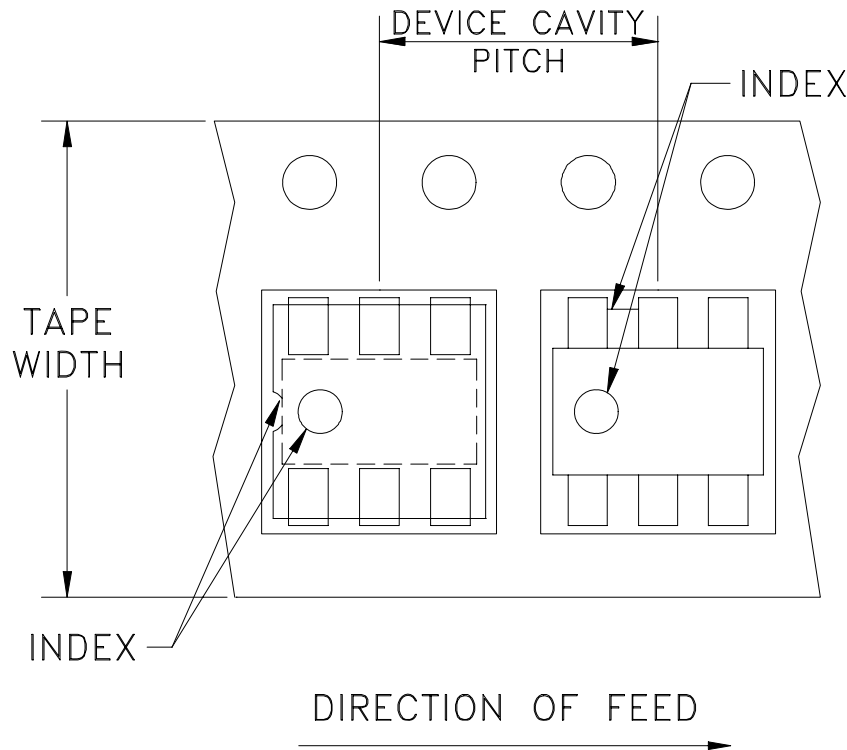

Tape Width, mm	Device Cavity Pitch, mm	Reel Size, inches	Devices per Reel see note
12	8	13	1000, 2000
		7	20, 50, 100, 200, 500

Note: Please consult individual model data sheet to determine device per reel availability.

Mini-Circuits carrier tape materials provide protection from ESD (Electro-Static Discharge) during handling and transportation. Tapes are static dissipative and comply with industry standards EIA-481/EIA-541.

Go to: [www.minicircuits.com/pages/pdfs/tape.pdf](http://www.minicircuits.com/pages/pdfs/tape.pdf)



INTERNET <http://www.minicircuits.com>

P.O. Box 350166, Brooklyn, New York 11235-0003 (718) 934-4500 Fax (718) 332-4661

Distribution Centers NORTH AMERICA 800-654-7949 • 417-335-5935 • Fax 417-335-5945 • EUROPE 44-1252-832600 • Fax 44-1252-837010

Mini-Circuits ISO 9001 & ISO 14001 Certified

THIRD ANGLE PROJECTION

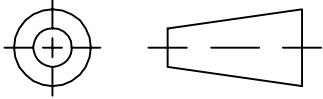

REVISIONS

REV	ECN No.	DESCRIPTION	DATE	DR	AUTH
OR	M70611	NEW RELEASE	02/00	IL	DB
A	M71500	ADDED SOLDER MASK AMD LEGEND	04/00	IL	DB
B	M82377	UPDATED DRAWING	08/06/02	GF	HY
C	M102713	UPDATED NOTES	02/15/06	AV	HY

SUGGESTED MOUNTING CONFIGURATION FOR DB714 CASE STYLE, "mt" PIN CONNECTION

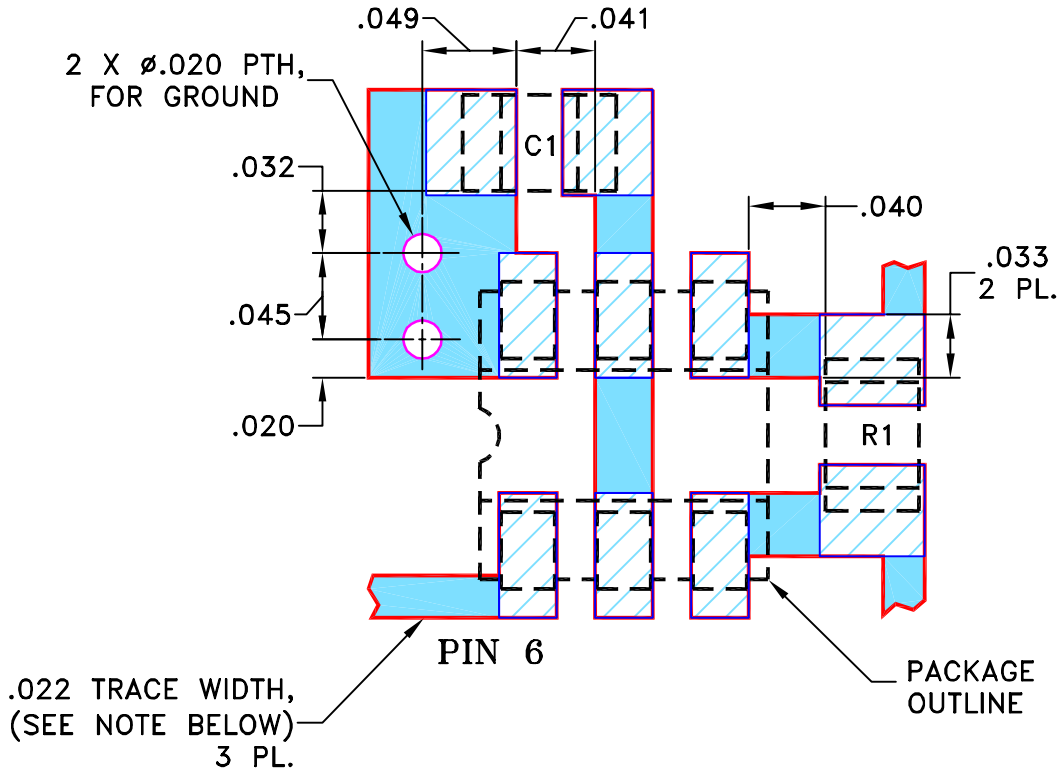

RESISTOR R1: 150 Ohm, 0805 SIZE  
 CAPACITOR C1: 1.5 pF, 0805 SIZE

- NOTES: 1. TRACE WIDTH IS SHOWN FOR ROGERS R04350B WITH DIELECTRIC THICKNESS 0.030" ± 0.002"; COPPER: 1 OZ. EACH SIDE. FOR OTHER MATERIALS TRACE WIDTH MAY NEED TO BE MODIFIED.
2. BOTTOM SIDE OF THE PCB IS CONTINUOUS GROUND PLANE.

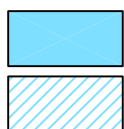

SOLID BLUE DENOTES PCB COPPER LAYOUT WITH SMOBC (SOLDER MASK OVER BARE COPPER)  
 HATCHED BLUE DENOTES COPPER LAND PATTERN FREE OF SOLDER MASK

UNLESS OTHERWISE SPECIFIED	INITIALS	DATE
DRAWN	IL	02/24/00
CHECKED	DY	02/29/00
APPROVED	DB	02/29/00



**Mini-Circuits®** 13 Neptune Avenue  
 Brooklyn NY 11235

PL, mt, 75, DB714, TCP

THIS DOCUMENT AND ITS CONTENTS ARE THE PROPERTY OF MINI-CIRCUITS. EXCEPT FOR USE EXPRESSLY GRANTED, IN WRITING, TO ITS VENDORS, VEEDEE AND THE UNITED STATES GOVERNMENT, MINI-CIRCUITS RESERVES ALL PROPRIETARY DESIGN, USE, MANUFACTURING AND REPRODUCTION RIGHTS THERETO. THESE CONTENTS SHALL NOT BE USED, DUPLICATED OR DISCLOSED TO ANY OUTSIDE PARTY, IN WHOLE OR IN PART, WITHOUT WRITTEN PERMISSION OF MINI-CIRCUITS.

SIZE A	CODE IDENT 15542	DRAWING NO: 98-PL-002	REV: C
FILE: 98PL002	SCALE: 10:1	SHEET: 1 OF 1	

# Evaluation Board and Circuit

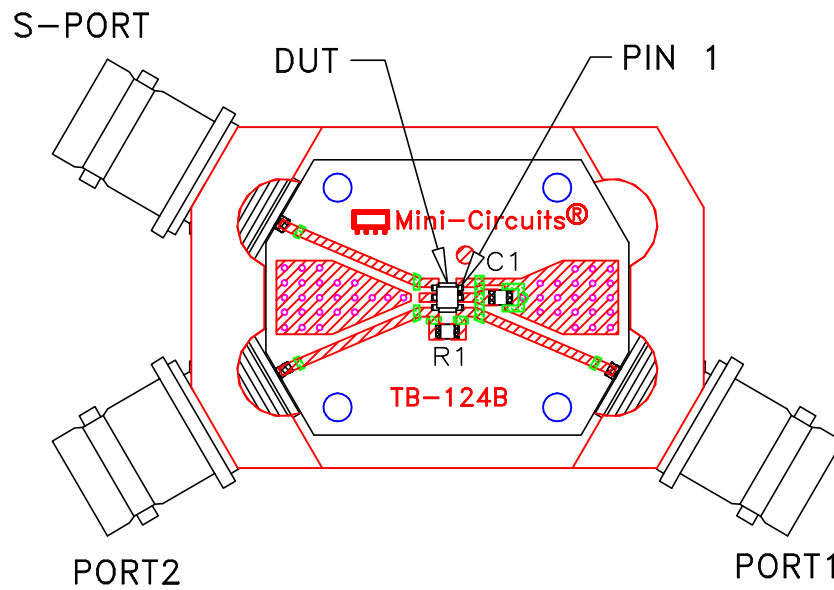

TB-124

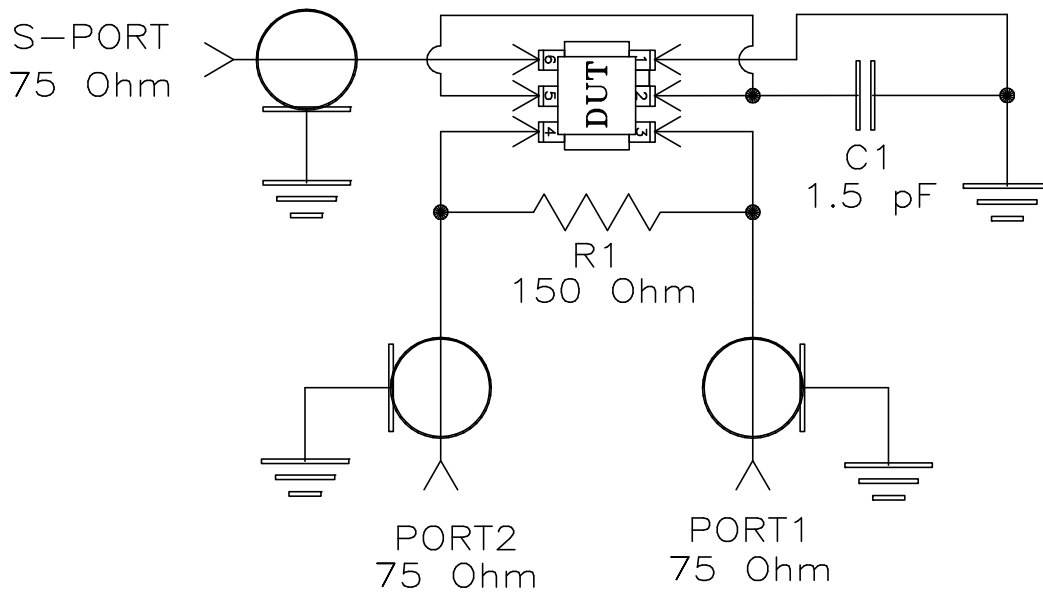

Schematic Diagram

## Notes:

1. 75 Ohm BNC Female connectors.
2. PCB Material: Rogers R04350 or equivalent,  
Dielectric Constant=3.5, Thickness=.030 inch.

 **Mini-Circuits®**



All Mini-Circuits products are manufactured under exacting quality assurance and control standards, and are capable of meeting published specifications after being subjected to any or all of the following physical and environmental test.

Specification	Test/Inspection Condition	Reference/Spec
Operating Temperature	-40° to 85°C Ambient Environment	Individual Model Data Sheet
Storage Temperature	-55° to 100° C Ambient Environment	Individual Model Data Sheet
Humidity	90 to 95% RH, 240 hours, 50°C	MIL-STD-202, Method 103, Condition A, Except 50°C and end-point electrical test done within 12 hours
Thermal Shock	-55° to 100°C, 100 cycles	MIL-STD-202, Method 107, Condition A-3, except +100°C
Solder Reflow Heat	Sn-Pb Eutetic Process: 225°C peak Pb-Free Process 245° - 250°C peak	J-STD-020, Table 4-1, 4-2 and 5-2, Figure 5-1
Solderability	10X Magnification	J-STD-002, 95% Coverage
Vibration (High Frequency)	20g peak, 10-2000 Hz, 12 times in each of three perpendicular directions (total 36)	MIL-STD-202, Method 204, Condition D
Mechanical Shock	50g, 11 ms, 1/2-sine, 18 shocks: 3 each direction, each of 3 axes	MIL-STD-202, Method 213, Condition A
Marking Resistance to Solvents	Isopropyl alcohol + mineral spirits at 25°C; terpene defluxer at 25°C; distilled water + proylene glycol monomethyl ether + monoethanolamine at 63°C to 70°C	MIL-STD-202, Method 215