

Ceramic Balun RF Transformer

75Ω 950 to 1450 MHz

TCN1-152-75+

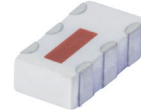

Generic photo used for illustration purposes only
CASE STYLE: FV1206-1

+RoHS Compliant
The +Suffix identifies RoHS Compliance. See our web site for RoHS Compliance methodologies and qualifications

Available Tape and Reel at no extra cost	
Reel Size	Devices/Reel
7"	20, 50, 100, 200, 500, 1000, 3000

Maximum Ratings

Operating Temperature	-40°C to 85°C
Storage Temperature	-55°C to 100°C
Input RF Power***	3W
*** Derate linearly to 2.5W at 100°C	
Permanent damage may occur if any of these limits are exceeded.	

Pad Connections

PRIMARY DOT (Unbalanced Port)	5
PRIMARY (GND)	4,6
SECONDARY DOT (Balanced)	3
SECONDARY (Balanced)	1
NO CONNECTION	2

Pads 1,3,4,6 are DC-connected internally

Features

- wideband, 950 to 1450 MHz
- low phase unbalance, 3 deg. typ.
- miniature size, 0.12"x.06"x.037"
- LTCC construction
- low cost
- aqueous washable

Applications

- Cable TV

Electrical Specifications (T_{AMB} = 25°C)

Ω RATIO	FREQUENCY (MHz)	INSERTION* LOSS (dB)	PHASE UNBALANCE† (Deg.) Typ.	AMPLITUDE UNBALANCE (dB) Typ.
1	950-1450	1.0	3	1.0

* Insertion Loss is referenced to mid-band loss, 0.8 dB. Reference Demo Board TB-417+

† Relative to 180°

Outline Drawing

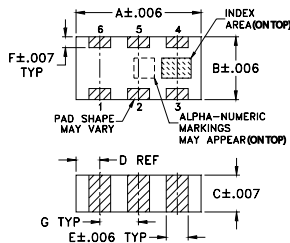

PCB Land Pattern

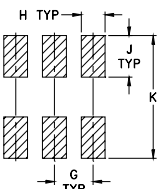

Suggested Layout, Tolerance to be within ±0.02

Outline Dimensions (inch/mm)

A	B	C	D	E	F
.126	.063	.035	.024	.022	.011
3.20	1.60	0.89	0.61	0.56	0.28
G	H	J	K	wt	
.039	.024	.042	.123	grams	
0.99	0.61	1.07	3.12	.020	

Demo Board MCL P/N: TB-417+ Suggested PCB Layout (PL-265)

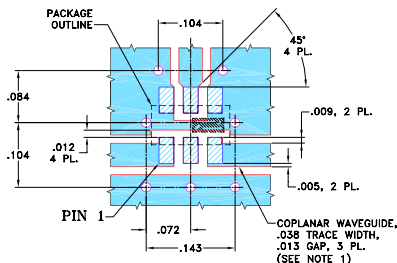

NOTES:

1. COPLANAR WAVEGUIDE PARAMETERS ARE SHOWN FOR ROGERS RO4350B WITH DIELECTRIC THICKNESS .020" ± .0015". COPPER: 1/2 OZ. EACH SIDE. FOR OTHER MATERIALS TRACE WIDTH AND GAP MAY NEED TO BE MODIFIED.
 2. BOTTOM SIDE OF THE PCB IS CONTINUOUS GROUND PLANE.
- DENOTES PCB COPPER LAYOUT WITH SMOBC (SOLDER MASK OVER BARE COPPER).
- DENOTES COPPER LAND PATTERN FREE OF SOLDER MASK

Notes

- A. Performance and quality attributes and conditions not expressly stated in this specification document are intended to be excluded and do not form a part of this specification document.
- B. Electrical specifications and performance data contained in this specification document are based on Mini-Circuit's applicable established test performance criteria and measurement instructions.
- C. The parts covered by this specification document are subject to Mini-Circuits standard limited warranty and terms and conditions (collectively, "Standard Terms"); Purchasers of this part are entitled to the rights and benefits contained therein. For a full statement of the Standard Terms and the exclusive rights and remedies thereunder, please visit Mini-Circuits' website at www.minicircuits.com/MCLStore/terms.jsp

Typical Performance Data at 25°C**

FREQUENCY (MHz)	INSERTION LOSS (dB)	INPUT R. LOSS (dB)	AMPLITUDE UNBALANCE (dB)	PHASE UNBALANCE (Deg.)
950.00	0.07	16.40	1.10	6.63
1000.00	0.02	19.14	1.04	6.10
1050.00	0.00	21.78	0.98	5.32
1100.00	0.00	22.90	0.92	4.67
1120.00	0.01	22.65	0.89	4.33
1200.00	0.04	19.87	0.84	2.91
1300.00	0.12	16.67	0.75	1.10
1350.00	0.17	15.40	0.72	0.24
1400.00	0.22	14.44	0.68	0.79
1450.00	0.26	13.59	0.65	1.66

** Measured with Agilent E5071B network analyzer using impedance conversion and port extension.

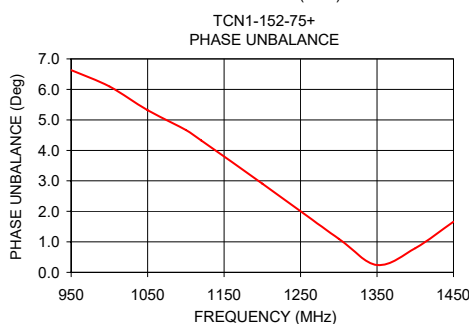
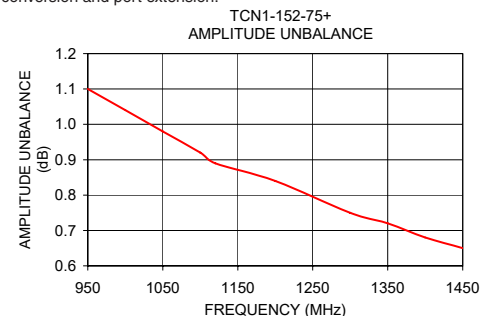
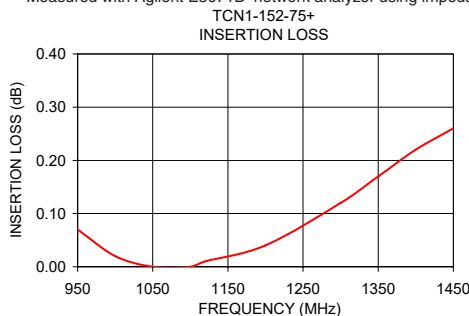

configuration J

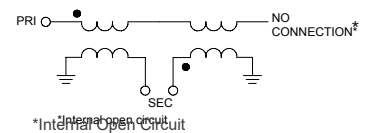

Typical Performance Data

FREQUENCY (MHz)	AVERAGE INSERTION LOSS* (dB)	INPUT RETURN LOSS (dB)	AMPLITUDE UNBALANCE (dB)	PHASE UNBALANCE** (deg)
950	0.07	16.40	1.10	6.63
975	0.04	17.76	1.07	6.39
1000	0.02	19.14	1.04	6.10
1025	0.01	20.50	1.01	5.76
1050	0.00	21.78	0.98	5.32
1075	0.00	22.66	0.95	4.99
1100	0.00	22.90	0.92	4.67
1120	0.01	22.65	0.89	4.33
1150	0.02	21.76	0.87	3.69
1175	0.03	20.84	0.86	3.28
1200	0.04	19.87	0.84	2.91
1225	0.06	18.90	0.82	2.50
1250	0.08	18.07	0.79	2.01
1275	0.09	17.36	0.77	1.57
1300	0.12	16.67	0.75	1.10
1325	0.14	15.99	0.74	0.67
1350	0.17	15.40	0.72	0.24
1375	0.19	14.90	0.69	0.27
1400	0.22	14.44	0.68	0.79
1450	0.26	13.59	0.65	1.66

* Insertion Loss is referenced to mid-band loss , 0.8 dB.

**Phase Unbalance is relative to 180°

Typical Performance Curves

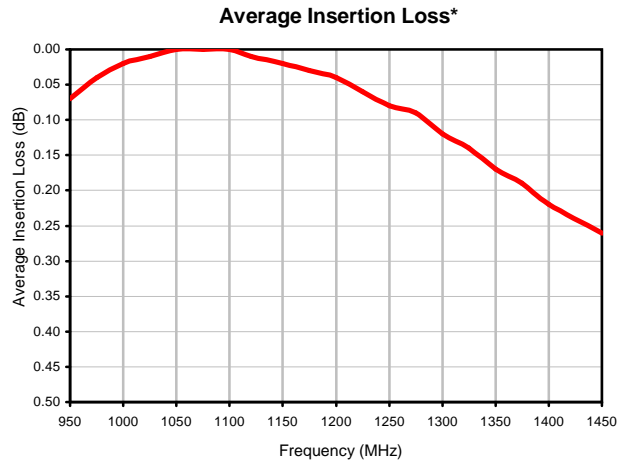

* Insertion Loss is referenced to mid-band loss , 0.8 dB.

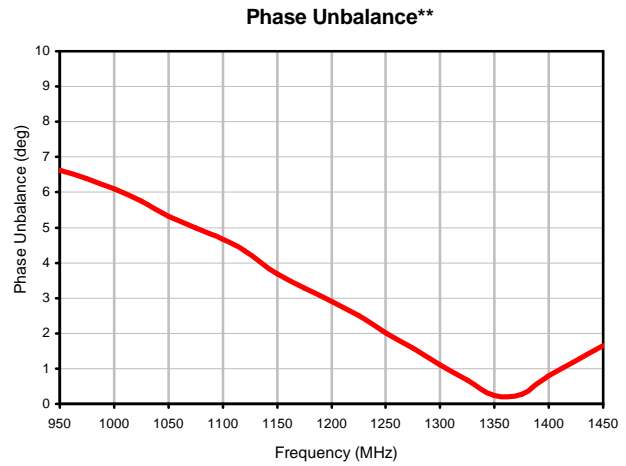
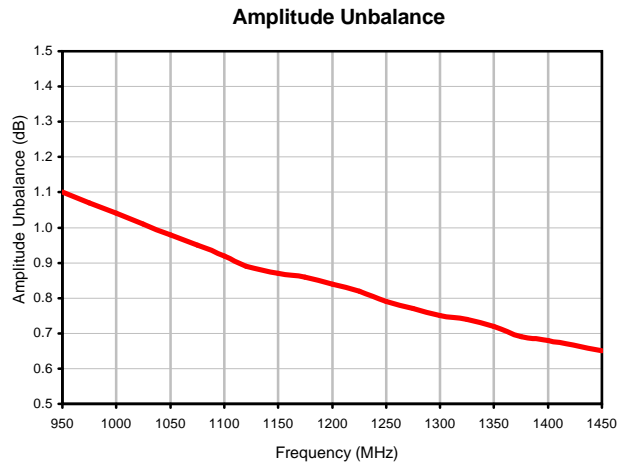

**Phase Unbalance is relative to 180°

Outline Dimensions

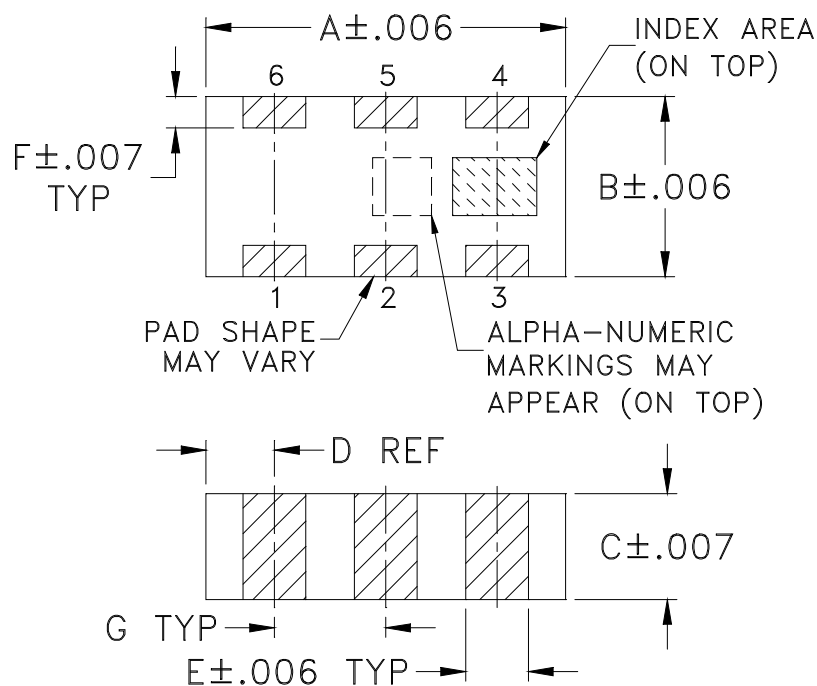

PCB Land Pattern

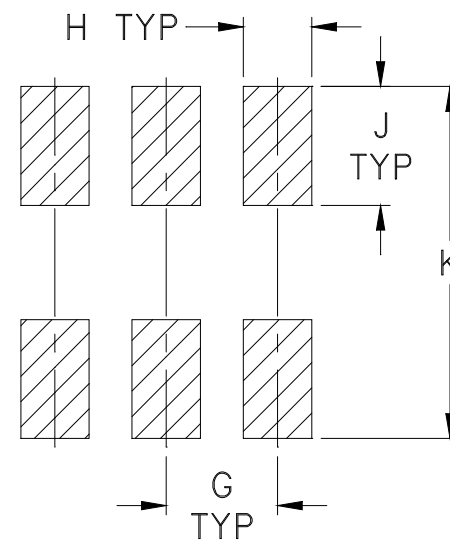

Suggested Layout,
Tolerance to be within $\pm.002$

CASE #	A	B	C	D	E	F	G	H	J	K	L	M	N	P	WT. GRAM
FV1206-1	.126 (3.20)	.063 (1.60)	.035 (0.89)	.024 (0.61)	.022 (0.56)	.011 (0.28)	.039 (0.99)	.024 (0.61)	.042 (1.07)	.123 (3.12)	--	--	--	--	.020

Dimensions are in inches (mm). Tolerances: 2 Pl. $\pm.01$; 3 Pl. $\pm.005$

Notes:

- Open style, ceramic base.
- Termination finish: **as shown below or indicated on Data Sheet.**
 For RoHS Case Styles: Tin plate over Nickel plate. All models, (+) suffix.
 For RoHS-5 Case Styles: Tin-Lead plate. All models, no (+) suffix.



P.O. Box 350166, Brooklyn, New York 11235-0003 (718) 934-4500 Fax (718) 332-4661 For detailed performance specs & shopping online see Mini-Circuits web site



The Design Engineers Search Engine Provides ACTUAL Data Instantly From MINI-CIRCUITS At: www.minicircuits.com

RF/IF MICROWAVE COMPONENTS

DEVICE ORIENTATION IN T&R

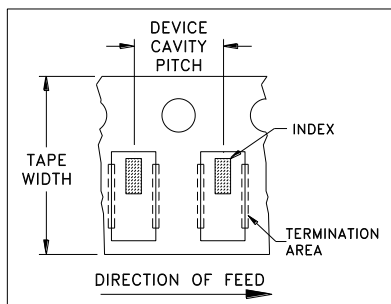

ILLUSTRATION 1

Applicable Case Styles
FV1206-1 FV1206-3

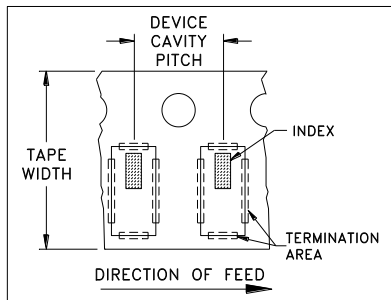

ILLUSTRATION 2

Applicable Case Styles
FV1206-4 FV1206-5 FV1206-6 FV1206-7 FV1206-9

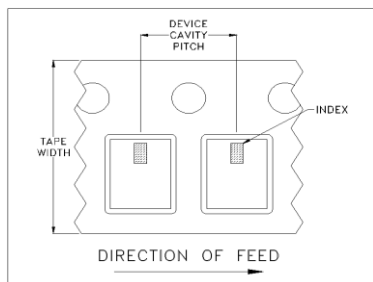

ILLUSTRATION 3

Applicable Case Styles
FV1206-12 GE0805C-18 NL1008C-6 NL1008C-7 NL1008C-9 NL1008C-10

Tape Width, mm	Device Cavity Pitch, mm	Reel Size, inches	Devices per Reel	
8	4	7	Small quantity standards (see note)	20
				50
				100
				200
				500
			1000	
			Standard	3000

Note: Please consult individual model data sheet to determine device per reel availability.

Mini-Circuits carrier tape materials provide protection from ESD (Electro-Static Discharge) during handling and transportation. Tapes are static dissipative and comply with industry standards EIA-481/EIA-541.

Go to: www.minicircuits.com/pages/pdfs/tape.pdf

Mini-Circuits ISO 9001 & ISO 14001 Certified

Mini-Circuits[®]

INTERNET <http://www.minicircuits.com>

P.O. Box 350166, Brooklyn, New York 11235-0003 (718) 934-4500 Fax (718) 332-4661

Distribution Centers NORTH AMERICA 800-654-7949 • 417-335-5935 • Fax 417-335-5945 • EUROPE 44-1252-832600 • Fax 44-1252-837010

Mini-Circuits ISO 9001 & ISO 14001 Certified

THIRD ANGLE PROJECTION

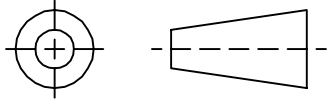

REVISIONS

REV OR	ECN No.	DESCRIPTION	DATE	DR	AUTH
	M109527	NEW RELEASE	01/31/07	PW	DJ

SUGGESTED MOUNTING CONFIGURATION
FOR FV1206-1 CASE STYLE, "sa" PIN CONNECTION.

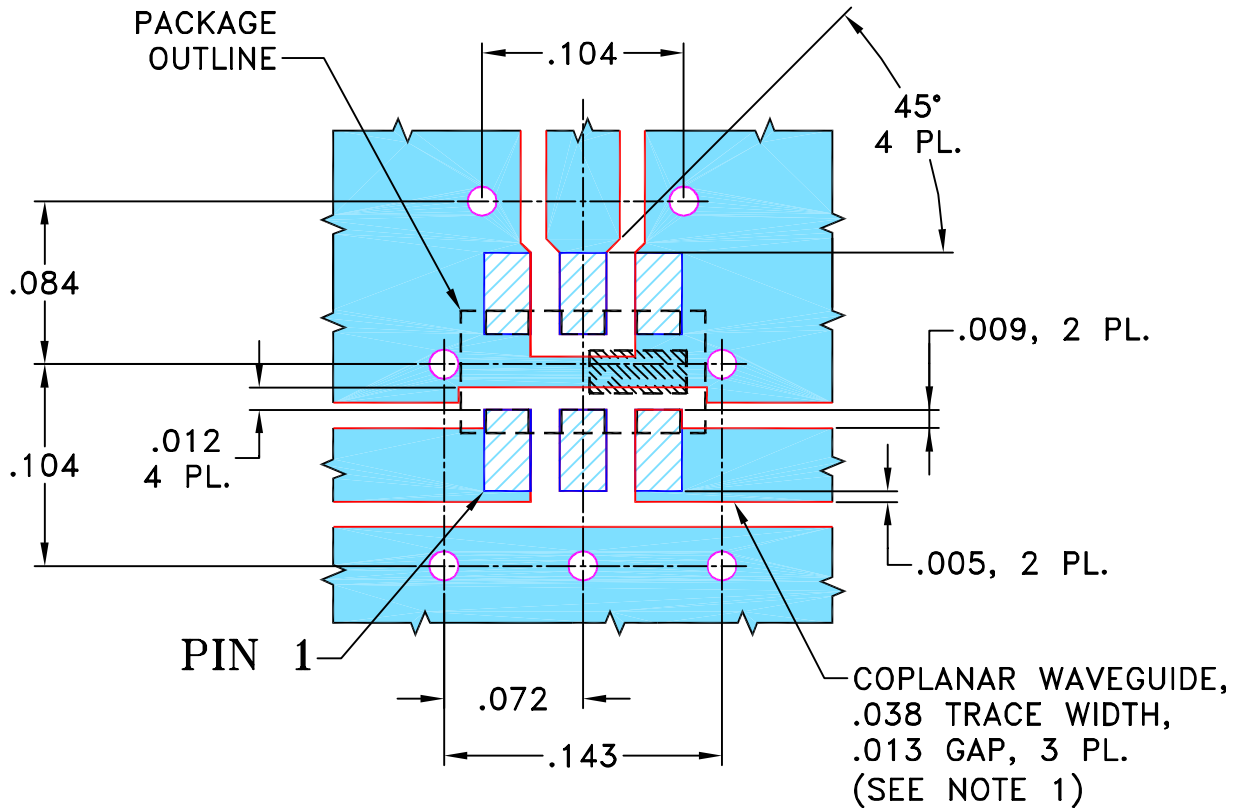

NOTES:

1. COPLANAR WAVEGUIDE PARAMETERS ARE SHOWN FOR ROGERS R04350B WITH DIELECTRIC THICKNESS $.020" \pm .0015"$. COPPER: 1/2 OZ. EACH SIDE. FOR OTHER MATERIALS TRACE WIDTH AND GAP MAY NEED TO BE MODIFIED.
2. BOTTOM SIDE OF THE PCB IS CONTINUOUS GROUND PLANE.



DENOTES PCB COPPER LAYOUT WITH SMOBC (SOLDER MASK OVER BARE COPPER).

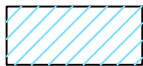

DENOTES COPPER LAND PATTERN FREE OF SOLDER MASK

UNLESS OTHERWISE SPECIFIED	INITIALS		DATE
DIMENSIONS ARE IN INCHES TOLERANCES ON: 2 PL DECIMALS ± 3 PL DECIMALS ± .005 ANGLES ± 1° FRACTIONS ±	DRAWN	PW	01/29/07
	CHECKED	IL	01/31/07
	APPROVED	DJ	01/31/07



Mini-Circuits®

13 Neptune Avenue
Brooklyn NY 11235

PL, sa, FV1206-1, TCN, TB-417+

THIS DOCUMENT AND ITS CONTENTS ARE THE PROPERTY OF MINI-CIRCUITS. EXCEPT FOR USE EXPRESSLY GRANTED, IN WRITING, TO ITS VENDORS, VENDEE AND THE UNITED STATES GOVERNMENT, MINI-CIRCUITS RESERVES ALL PROPRIETARY DESIGN, USE, MANUFACTURING AND REPRODUCTION RIGHTS THERETO. THESE CONTENTS SHALL NOT BE USED, DUPLICATED OR DISCLOSED TO ANY OUTSIDE PARTY, IN WHOLE OR IN PART, WITHOUT WRITTEN PERMISSION OF MINI-CIRCUITS.

SIZE A	CODE IDENT 15542	DRAWING NO: 98-PL-265	REV: OR
FILE: 98PL265	SCALE: 10:1	SHEET: 1 OF 1	

Evaluation Board and Circuit

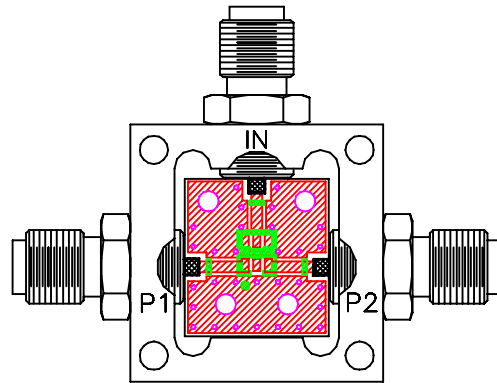

TB-417+

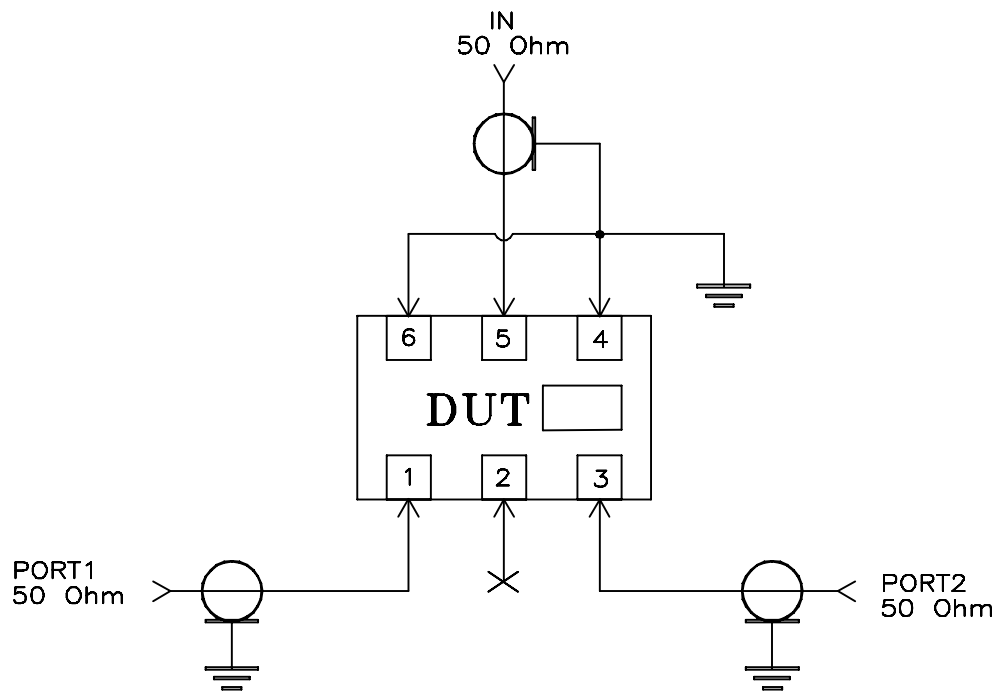

Schematic Diagram

Notes:

1. SMA Female connectors.
2. PCB Material: Rogers R04350 or equivalent,
Dielectric Constant=3.5, Thickness=.010 inch.

 Mini-Circuits®

All Mini-Circuits products are manufactured under exacting quality assurance and control standards, and are capable of meeting published specifications after being subjected to any or all of the following physical and environmental test.

Specification	Test/Inspection Condition	Reference/Spec
Operating Temperature	-40° to 85° C Ambient Environment	Individual Model Data Sheet
Storage Temperature	-55° to 100° C Ambient Environment	Individual Model Data Sheet
Humidity	90 to 95% RH, 240 hours, 50°C	MIL-STD-202, Method 103, Condition A, Except 50°C and end-point electrical test done within 12 hours
Thermal Shock	-55° to 100°C, 100 cycles	MIL-STD-202, Method 107, Condition A-3, except +100°C
Solder Reflow Heat	Sn-Pb Eutetic Process: 225°C peak Pb-Free Process 245° - 250°C peak	J-STD-020, Table 4-1, 4-2 and 5-2, Figure 5-1
Solderability	10X Magnification	J-STD-002, Para 4.2.5, Test S, 95% Coverage
Vibration (High Frequency)	20g peak, 10-2000 Hz, 12 times in each of three perpendicular directions (total 36)	MIL-STD-202, Method 204, Condition D
Mechanical Shock	50g, 11 ms, 1/2-sine, 18 shocks: 3 each direction, each of 3 axes	MIL-STD-202, Method 213, Condition A