



top hat SURFACE MOUNT RF Transformer

TCM2-672AX+

50Ω 1500 to 6700 MHz

THE BIG DEAL

- Wideband, 1500 to 6700 MHz
Balanced transmission line
Low insertion loss 0.8 dB at 4 GHz
Flat insertion loss, 0.6 dB typ.
Good input return loss, 15 dB typ.
Low phase and amplitude unbalance, 6°, 0.8 dB at 4 GHz
Aqueous washable



CASE STYLE: DB1627

Generic photo used for illustration purposes only

+RoHS Compliant

The +Suffix identifies RoHS Compliance. See our website for methodologies and qualifications

APPLICATIONS

- PCS
Wideband push-pull amplifiers
Cellular

PRODUCT OVERVIEW

Mini-Circuits' TCM2-672AX+ is a surface-mount transmission line core and wire transformer covering a very wide frequency range from 1500 to 6700 MHz. The transformer provides low insertion loss with excellent flatness over its entire frequency range. It achieves low phase and amplitude unbalance and excellent input return loss performance. Featuring core and wire construction on a 6-lead plastic base with tin over nickel termination finish, the unit measures 0.16 x 0.15 x 0.16", accommodating dense circuit board layouts. It also incorporates Mini-Circuits' Top Hat® feature for faster, more accurate pick-and-place assembly and easy visual inspection.

KEY FEATURES

Table with 2 columns: Feature and Advantages. Rows include Wide band (1500 to 6700 MHz), Low insertion loss (0.8 dB at 4 GHz), Good input return loss (15 dB typ.), Small footprint (0.16 x 0.15 x 0.16"), and Top Hat® feature.



### ELECTRICAL SPECIFICATIONS AT 25°C

Parameter	Frequency (MHz)	Min.	Typ.	Max.	Units
Impedance Ratio (secondary/primary)			2		Ohm
Frequency Range		1500		6700	MHz
Insertion Loss <sup>1</sup>	1500-4000	-	0.8	1.5	dB
	4000-6700	-	2.1	3.2	
Amplitude Unbalance	1500-3800	-	0.8	-	dB
	3800-6700	-	1.8	-	
Phase Unbalance	1500-3800	-	6	-	Degree
	3800-6700	-	12	-	
Return Loss	1500-6700	-	15	-	dB

1. Referenced to nominal loss of 0.2 dB typ.

### MAXIMUM RATINGS

Parameter	Ratings
Operating Temperature	-40°C to 85°C
Storage Temperature	-55°C to 100°C
RF Power	0.4 W
DC Current	30 mA

### CONFIGURATION G

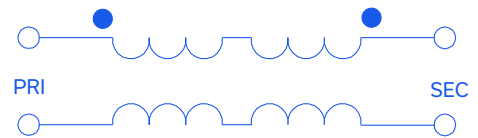



**PIN CONNECTIONS**

PRIMARY DOT	3
PRIMARY (GND)	2
SECONDARY DOT	4
SECONDARY	5
NOT USED	1,6

**PRODUCT MARKING: YL**

**DEMOBOARD MCL P/N: TB-TCM2-672AX+  
SUGGESTED PCB LAYOUT (PL-422)**

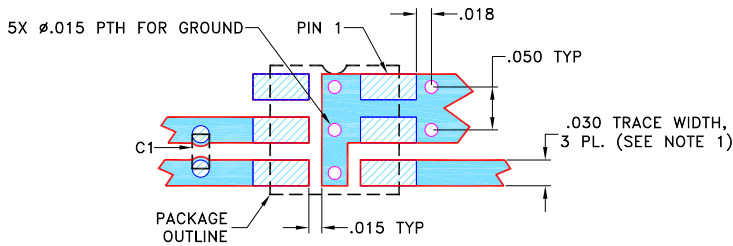

COMPONENT	SIZE
C1	0402

**NOTES:**

- TRACE WIDTH PARAMETERS ARE SHOWN FOR ROGERS RO4350B WITH DIELECTRIC THICKNESS .0133"±.001". COPPER: 1/2 OZ. EACH SIDE. FOR OTHER MATERIALS TRACE WIDTH MAY NEED TO BE MODIFIED.
- CHIP COMPONENT FOOT PRINTS SHOWN FOR REFERENCE. FOR COMPONENT VALUES REFER TO TB-742+.
- BOTTOM SIDE OF THE PCB IS CONTINUOUS GROUND PLANE.
  - DENOTES PCB COPPER LAYOUT WITH SMOBC (SOLDER MASK OVER BARE COPPER).
  - DENOTES COPPER LAND PATTERN FREE OF SOLDER MASK.

**OUTLINE DRAWING**

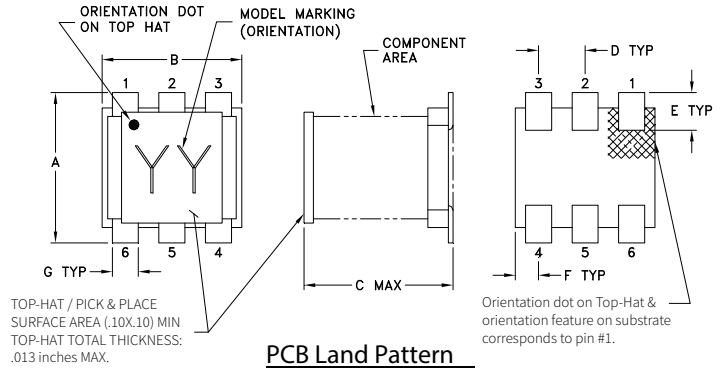

**PCB Land Pattern**

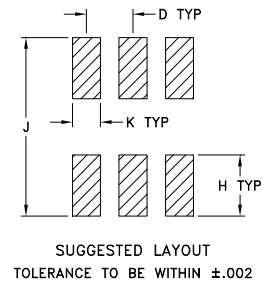

**OUTLINE DIMENSIONS (Inches/mm)**

A	B	C	D	E	F
.160	.150	.160	.050	.040	.025
4.06	3.81	4.06	1.27	1.02	0.64
G	H	J	K	wt	
.028	.065	.190	.030	grams	
0.71	1.65	4.83	0.76	0.15	

**TAPE & REEL INFORMATION: F47**



### TYPICAL PERFORMANCE DATA

Frequency (MHz)	Insertion Loss (dB)	Return Loss (dB)	Amplitude Unbalance (dB)	Phase Unbalance (deg)
1500	0.48	15.53	0.65	3.09
2200	0.44	26.48	0.36	6.70
2500	0.52	19.67	0.11	7.81
3100	0.75	13.84	0.23	6.93
3400	0.76	13.79	0.23	6.76
4000	0.79	15.56	0.53	4.59
4600	0.96	14.00	0.26	0.16
5200	1.11	13.17	0.13	3.39
6100	1.56	12.13	0.46	6.60
6700	2.05	10.36	0.64	4.57

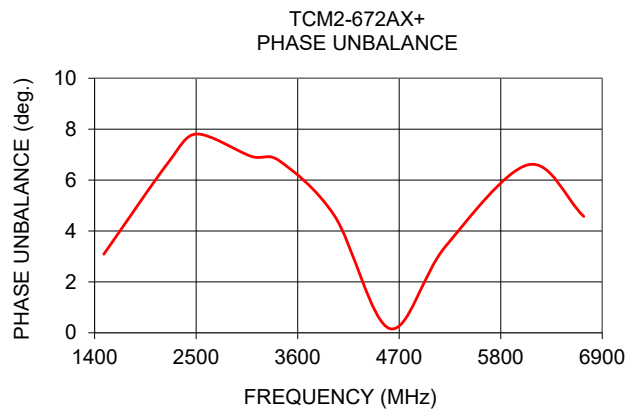
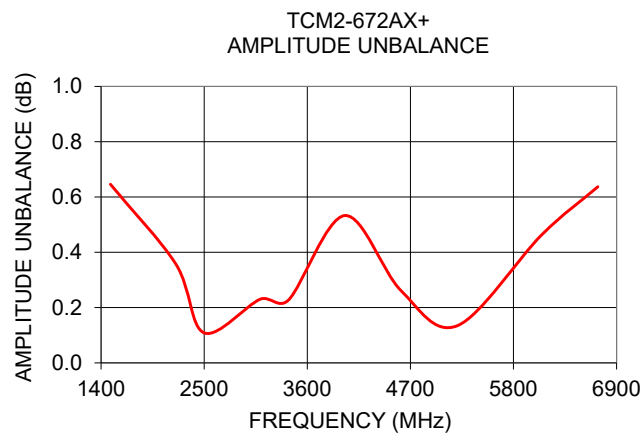
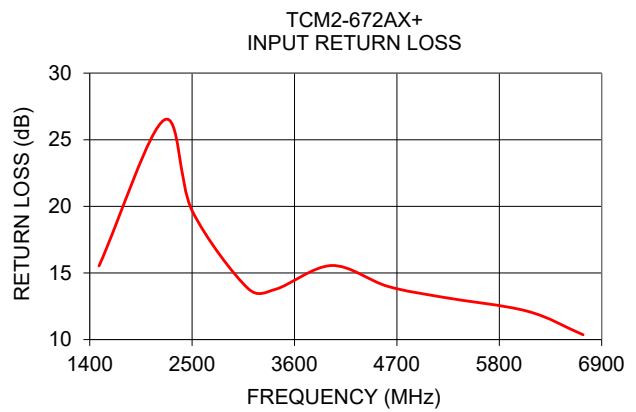
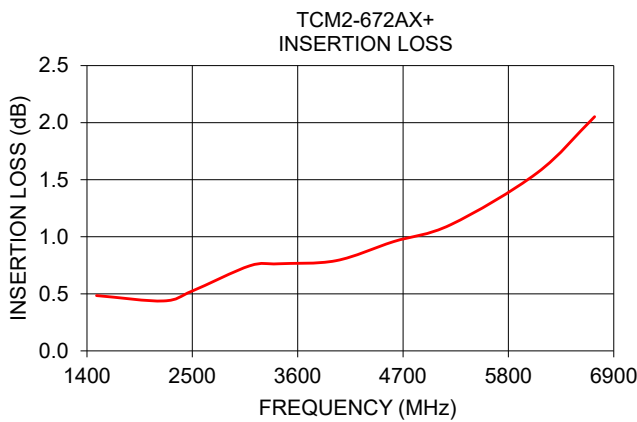

- NOTES**
- A. Performance and quality attributes and conditions not expressly stated in this specification document are intended to be excluded and do not form a part of this specification document.
  - B. Electrical specifications and performance data contained in this specification document are based on Mini-Circuit's applicable established test performance criteria and measurement instructions.
  - C. The parts covered by this specification document are subject to Mini-Circuits standard limited warranty and terms and conditions (collectively, "Standard Terms"); Purchasers of this part are entitled to the rights and benefits contained therein. For a full statement of the standard. Terms and the exclusive rights and remedies thereunder, please visit Mini-Circuits' website at [www.minicircuits.com/terms/viewterm.html](http://www.minicircuits.com/terms/viewterm.html)

# RF Transformer

# TCM2-672AX+

## Typical Performance Data

FREQUENCY MHz	AVERAGE INSERTION LOSS (dB)	INPUT RETURN LOSS (dB)	AMPLITUDE UNBALANCE (dB)	PHASE UNBALANCE (deg.)
1500	0.48	15.53	0.65	3.09
1600	0.46	16.67	0.58	3.59
1700	0.44	18.08	0.55	4.14
1800	0.43	19.69	0.51	4.64
1900	0.42	21.77	0.48	5.05
2050	0.42	25.25	0.43	5.85
2200	0.44	26.48	0.36	6.70
2350	0.47	23.12	0.24	7.37
2500	0.52	19.67	0.11	7.81
2650	0.59	17.23	0.03	7.79
2800	0.65	15.55	0.14	7.59
2950	0.71	14.46	0.22	7.19
3100	0.75	13.84	0.23	6.93
3250	0.77	13.63	0.22	6.82
3400	0.76	13.79	0.23	6.76
3550	0.76	14.19	0.31	6.63
3700	0.76	14.72	0.40	6.27
3850	0.77	15.18	0.52	5.54
4000	0.79	15.56	0.53	4.59
4150	0.81	15.57	0.53	3.04
4300	0.86	15.24	0.45	1.82
4450	0.89	14.55	0.37	0.73
4600	0.96	14.00	0.26	0.16
4750	0.98	13.48	0.20	0.46
4900	1.04	13.21	0.18	1.25
5050	1.06	13.07	0.15	2.00
5200	1.11	13.17	0.13	3.39
5350	1.15	13.35	0.02	4.39
5500	1.20	13.37	0.01	5.60
5650	1.28	13.38	0.18	6.04
5800	1.35	13.04	0.26	6.68
5950	1.47	12.68	0.40	6.46
6100	1.56	12.13	0.46	6.60
6200	1.64	11.79	0.48	6.47
6300	1.71	11.47	0.49	6.38
6400	1.78	11.17	0.51	6.30
6500	1.86	10.88	0.53	6.00
6600	1.94	10.67	0.57	5.33
6700	2.05	10.36	0.64	4.57

## Typical Performance Data

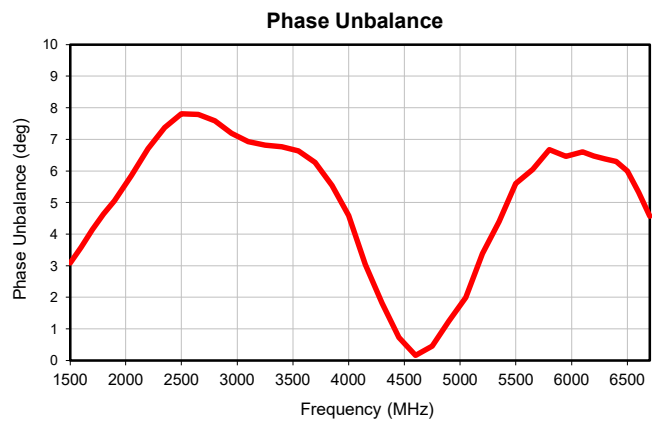
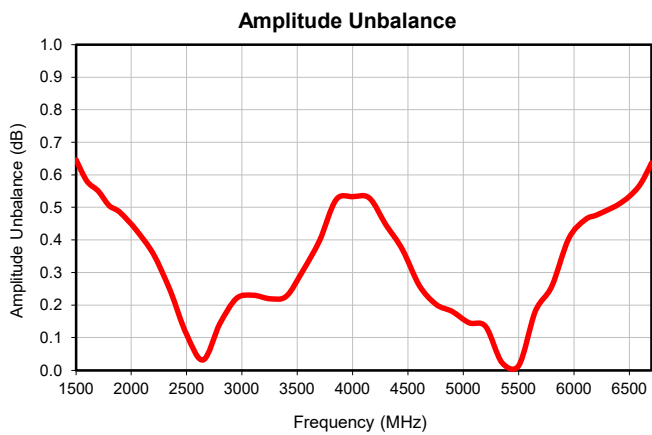
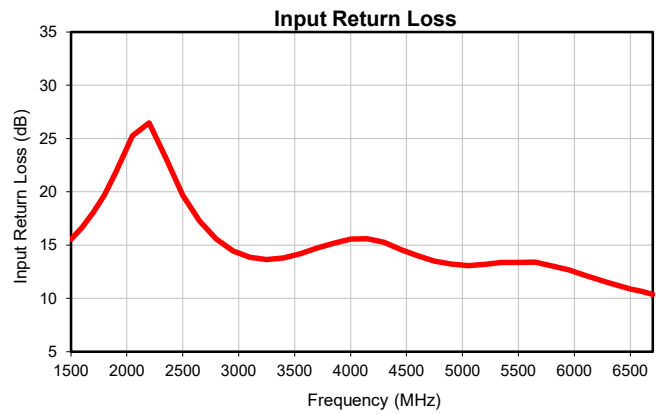
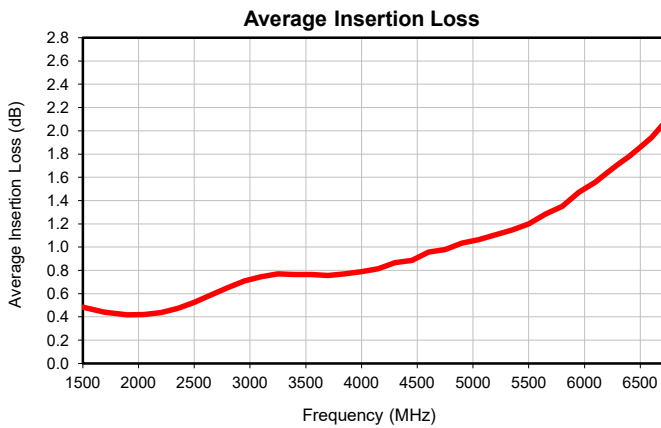

### Outline Dimensions

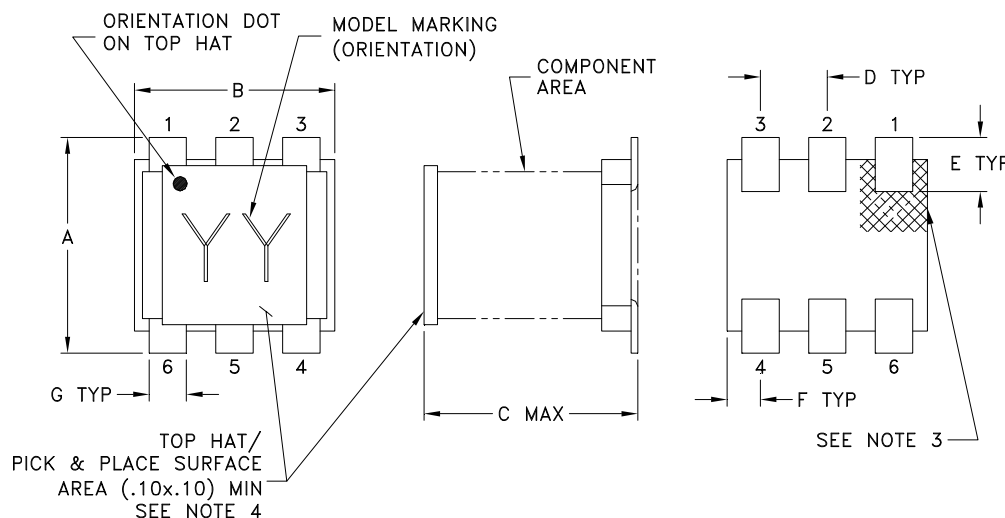

### PCB Land Pattern

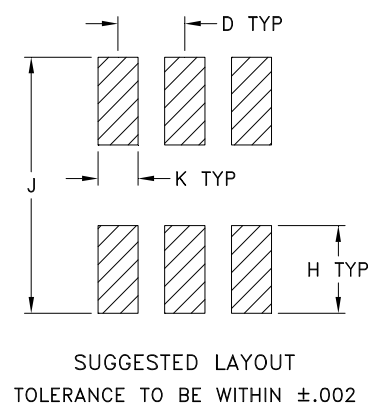

CASE #	A	B	C	D	E	F	G	H	J	K	WT. GRAM
DB1627	.160 (4.06)	.150 (3.81)	.160 (4.06)	.050 (1.27)	.040 (1.02)	.025 (0.64)	.028 (0.71)	.065 (1.65)	.190 (4.83)	.030 (0.76)	.15

Dimensions are in inches (mm). Tolerances: 2 Pl.  $\pm .01$ ; 3Pl.  $\pm .005$

#### Notes:

- Case material: Plastic.
- Termination finish:  
For RoHS Case Styles: Tin plate over Nickel plate. All models, (+) suffix.  
For RoHS-5 Case Styles: Tin-Lead plate. All models, no (+) suffix.
- Orientation dot on top hat & orientation feature on substrate correspondence to pin #1.
- Top-Hat total thickness: .013 inches MAX.

# Tape & Reel Packaging TR-F47

## DEVICE ORIENTATION IN T&R

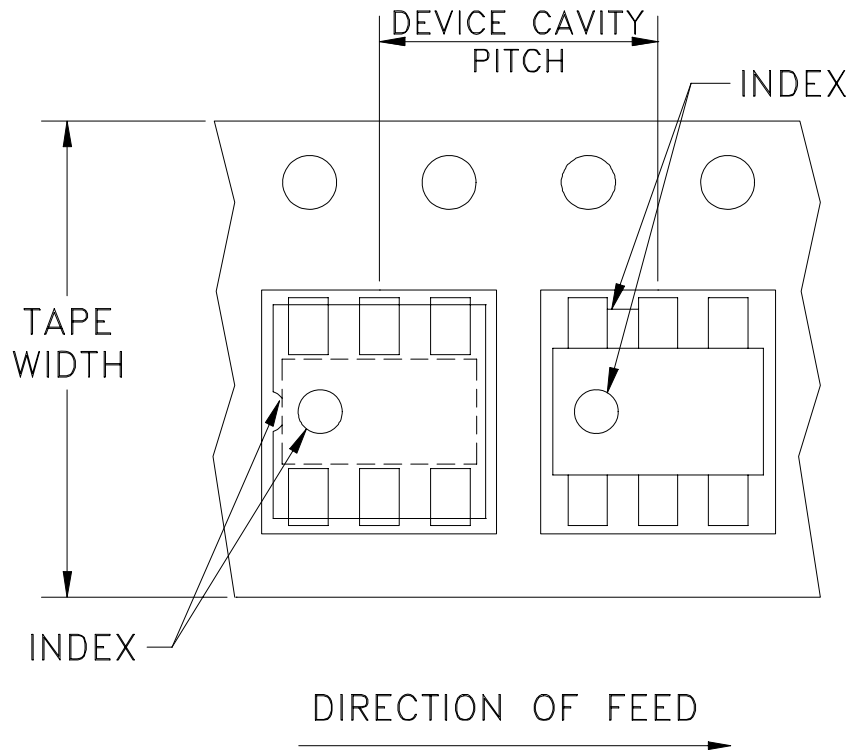

Tape Width, mm	Device Cavity Pitch, mm	Reel Size, inches	Devices per Reel see note
12	8	13	1000, 2000
		7	20, 50, 100, 200, 500

Note: Please consult individual model data sheet to determine device per reel availability.

Mini-Circuits carrier tape materials provide protection from ESD (Electro-Static Discharge) during handling and transportation. Tapes are static dissipative and comply with industry standards EIA-481/EIA-541.

Go to: [www.minicircuits.com/pages/pdfs/tape.pdf](http://www.minicircuits.com/pages/pdfs/tape.pdf)

**Mini-Circuits**<sup>®</sup>

INTERNET <http://www.minicircuits.com>

P.O. Box 350166, Brooklyn, New York 11235-0003 (718) 934-4500 Fax (718) 332-4661

Distribution Centers NORTH AMERICA 800-654-7949 • 417-335-5935 • Fax 417-335-5945 • EUROPE 44-1252-832600 • Fax 44-1252-837010

Mini-Circuits ISO 9001 & ISO 14001 Certified



THIRD ANGLE PROJECTION

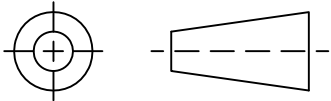

REVISIONS

REV	ECN No.	DESCRIPTION	DATE	DR	AUTH
OR	M147897	NEW RELEASE	08/20/14	ITG	DJ

SUGGESTED MOUNTING CONFIGURATION  
FOR DB714 CASE STYLE, "06TG04" PIN CODE

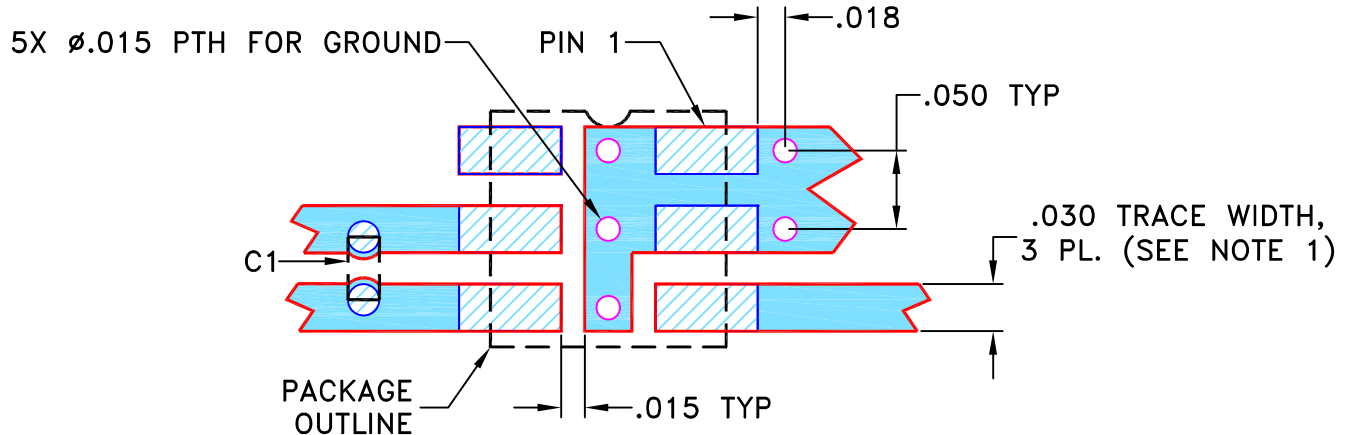

COMPONENT	SIZE
C1	0402

NOTES:

1. TRACE WIDTH PARAMETERS ARE SHOWN FOR ROGERS R04350B WITH DIELECTRIC THICKNESS  $.0133 \pm .001$ ". COPPER: 1/2 OZ. EACH SIDE. FOR OTHER MATERIALS TRACE WIDTH MAY NEED TO BE MODIFIED.
2. CHIP COMPONENT FOOT PRINTS SHOWN FOR REFERENCE. FOR COMPONENT VALUES REFER TO TB-742+.
3. BOTTOM SIDE OF THE PCB IS CONTINUOUS GROUND PLANE.

 DENOTES PCB COPPER LAYOUT WITH SMOBC (SOLDER MASK OVER BARE COPPER).

 DENOTES COPPER LAND PATTERN FREE OF SOLDER MASK.

UNLESS OTHERWISE SPECIFIED	INITIALS		DATE
DIMENSIONS ARE IN INCHES	DRAWN	ITG	08/20/14
TOLERANCES ON:	CHECKED	GF	08/20/14
2 PL DECIMALS $\pm$	APPROVED	DJ	08/20/14
3 PL DECIMALS $\pm$ .005			
ANGLES $\pm$			
FRACTIONS $\pm$			

 **Mini-Circuits<sup>®</sup>** 13 Neptune Avenue  
Brooklyn NY 11235

PL, 06TG04, DB714, TB-742+

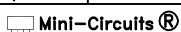
 Mini-Circuits<sup>®</sup>  
THIS DOCUMENT AND ITS CONTENTS ARE THE PROPERTY OF MINI-CIRCUITS. EXCEPT FOR USE EXPRESSLY GRANTED, IN WRITING, TO ITS VENDORS, VENDEE AND THE UNITED STATES GOVERNMENT, MINI-CIRCUITS RESERVES ALL PROPRIETARY DESIGN, USE, MANUFACTURING AND REPRODUCTION RIGHTS THERETO. THESE CONTENTS SHALL NOT BE USED, DUPLICATED OR DISCLOSED TO ANY OUTSIDE PARTY, IN WHOLE OR IN PART, WITHOUT WRITTEN PERMISSION OF MINI-CIRCUITS.

SIZE	CODE IDENT	DRAWING NO:	REV:
A	15542	98-PL-422	OR
FILE:	98PL422	SCALE: 8:1	SHEET: 1 OF 1

All Mini-Circuits products are manufactured under exacting quality assurance and control standards, and are capable of meeting published specifications after being subjected to any or all of the following physical and environmental test.

Specification	Test/Inspection Condition	Reference/Spec
Operating Temperature	-40° to 85°C Ambient Environment	Individual Model Data Sheet
Storage Temperature	-55° to 100° C Ambient Environment	Individual Model Data Sheet
Humidity	90 to 95% RH, 240 hours, 50°C	MIL-STD-202, Method 103, Condition A, Except 50°C and end-point electrical test done within 12 hours
Thermal Shock	-55° to 100°C, 100 cycles	MIL-STD-202, Method 107, Condition A-3, except +100°C
Solder Reflow Heat	Sn-Pb Eutetic Process: 225°C peak Pb-Free Process 245° - 250°C peak	J-STD-020, Table 4-1, 4-2 and 5-2, Figure 5-1
Solderability	10X Magnification	J-STD-002, 95% Coverage
Vibration (High Frequency)	20g peak, 10-2000 Hz, 12 times in each of three perpendicular directions (total 36)	MIL-STD-202, Method 204, Condition D
Mechanical Shock	50g, 11 ms, 1/2-sine, 18 shocks: 3 each direction, each of 3 axes	MIL-STD-202, Method 213, Condition A
Marking Resistance to Solvents	Isopropyl alcohol + mineral spirits at 25°C; terpene defluxer at 25°C; distilled water + proylene glycol monomethyl ether + monoethanolamine at 63°C to 70°C	MIL-STD-202, Method 215