

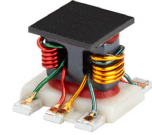

# Directional Coupler **TCD-10-1W-75X+**

## FEATURES

- Wideband, 10 to 750 MHz
- Low mainline loss, 1.4 dB typ.
- Aqueous washable
- Leads for excellent solderability
- Protected by US Patent 6,140,887



Generic photo used for illustration purposes only

CASE STYLE: DB1627

## APPLICATIONS

- VHF/UHF
- CATV
- Communications

### +RoHS Compliant

The +Suffix identifies RoHS Compliance.  
See our website for methodologies and qualifications

## ELECTRICAL SPECIFICATIONS AT 25°C

Parameter	Frequency (MHz)	Min.	Typ.	Max.	Unit
Frequency Range	—	5	—	2000	MHz
Mainline Loss <sup>1</sup>	10-100	—	1.6	2.1	dB
	100-350	—	1.4	1.9	
	350-750	—	2.5	2.0	
Coupling		—	10.5±0.5	—	dB
Coupling Flatness (±)		—	±0.7	—	dB
Directivity	10-100	—	22	—	dB
	100-350	—	18	—	
	350-750	—	14	—	
VSWR	10-750	—	1.3	—	:1
Input Power	10-100	—	—	0.5	W
	100-750	—	—	1.0	

1. Mainline loss includes theoretical power loss at coupled port.

## MAXIMUM RATINGS

Parameter	Ratings
Operating Temperature	-40°C to 85°C*
Storage Temperature	-55°C to 100°C

Permanent damage may occur if any of these limits are exceeded.

\* Case temperature is defined as temperature on ground leads.

## ELECTRICAL SCHEMATIC

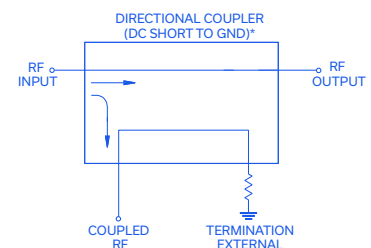

\*Electrical schematic is for Directional coupler with internal transformer(s) and external termination



# Directional Coupler **TCD-10-1W-75X+**

### PIN CONNECTIONS

INPUT	3
OUTPUT	4
COUPLED	1
GROUND	2
75Ω TERM EXTERNAL	6
NOT USED	5

**PRODUCT MARKING:** DC

### DEMO BOARD MCL P/N: TB-72 SUGGESTED PCB LAYOUT (PL-010)

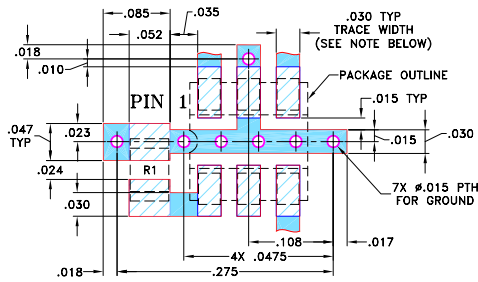

RESISTOR R1: 75 ± 1% Ohm, 0805 SIZE

- NOTES:**
- TRACE WIDTH IS SHOWN FOR ROGERS RO4350B WITH DIELECTRIC THICKNESS 0.030" ± 0.002"; COPPER: 1/2 OZ. EACH SIDE. FOR OTHER MATERIALS TRACE WIDTH MAY NEED TO BE MODIFIED.
  - BOTTOM SIDE OF THE PCB IS CONTINUOUS GROUND PLANE.

- DENOTES PCB COPPER LAYOUT WITH SMOBC (SOLDER MASK OVER BARE COPPER)
- DENOTES COPPER LAND PATTERN FREE OF SOLDER MASK

### OUTLINE DRAWING

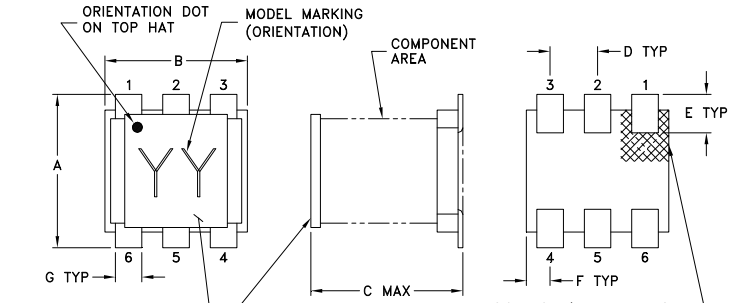

TOP-HAT / PICK & PLACE SURFACE AREA (10X.10) MIN  
TOP-HAT TOTAL THICKNESS: .013 inches MAX.

Orientation dot on Top-Hat & orientation feature on substrate corresponds to pin #1.

### PCB Land Pattern

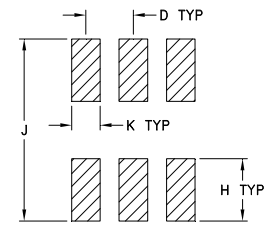

SUGGESTED LAYOUT TOLERANCE TO BE WITHIN ±.002

### OUTLINE DIMENSIONS (Inches mm)

A	B	C	D	E	F
.160	.150	.160	.050	.040	.025
4.06	3.81	4.06	1.27	1.02	0.64
G	H	J	K		wt
.028	.065	.190	.030		grams
0.71	1.65	4.83	0.76		0.15

### TAPE & REEL INFORMATION: F47



# Directional Coupler **TCD-10-1W-75X+**

**TYPICAL PERFORMANCE DATA**

Frequency (MHz)	Mainline Loss (dB)		Coupling (dB)	Directivity (dB)	Return Loss (dB)		
	In-Out	In-Cpl			In	Out	Cpl
9.00	1.46	10.50	22.09	17.37	24.83	18.42	
18.00	1.42	10.49	22.05	17.64	30.73	18.75	
24.00	1.43	10.50	22.01	17.64	31.76	18.75	
30.00	1.44	10.51	21.95	17.61	30.54	18.73	
50.00	1.45	10.53	21.81	17.56	29.29	18.70	
70.00	1.46	10.53	21.69	17.57	27.94	18.68	
100.00	1.46	10.54	21.52	17.64	27.64	18.69	
300.00	1.41	10.49	19.89	18.33	26.14	19.24	
500.00	1.38	10.43	17.95	19.30	24.85	19.95	
800.00	1.42	10.31	15.43	21.16	24.64	21.29	

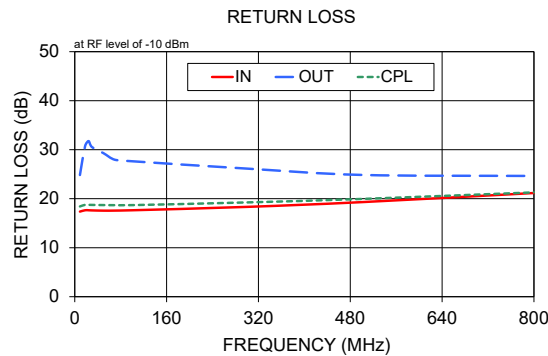
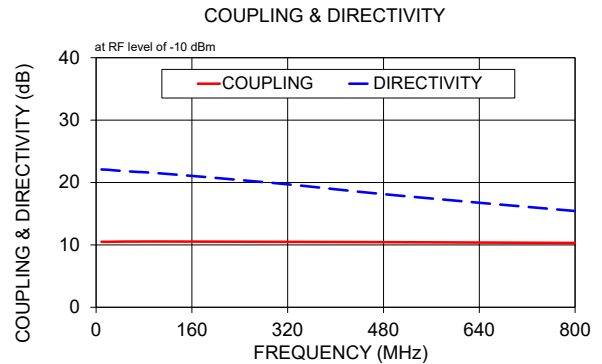
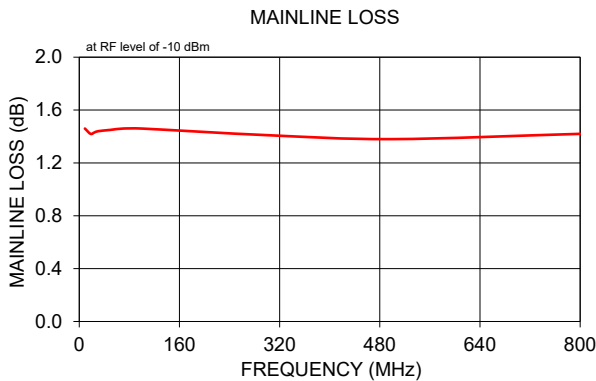

- NOTES**
- A. Performance and quality attributes and conditions not expressly stated in this specification document are intended to be excluded and do not form a part of this specification document.
  - B. Electrical specifications and performance data contained in this specification document are based on Mini-Circuit's applicable established test performance criteria and measurement instructions.
  - C. The parts covered by this specification document are subject to Mini-Circuits standard limited warranty and terms and conditions (collectively, "Standard Terms"); Purchasers of this part are entitled to the rights and benefits contained therein. For a full statement of the standard. Terms and the exclusive rights and remedies thereunder, please visit Mini-Circuits' website at [www.minicircuits.com/terms/viewterm.html](http://www.minicircuits.com/terms/viewterm.html)

# Directional Coupler

# TCD-10-1W-75X+

## Typical Performance Data

TEST CONDITIONS: INPUT POWER =0 dBm @Temperature = +25°C

FREQUENCY (MHz)	INSERTION LOSS (dB)	COUPLING LOSS (dB)	DIRECTIVITY (dB)	RETURN LOSS (dB)		
				IN	OUT	CPL
10	1.54	10.28	20.27	16.16	22.09	16.02
20	1.52	10.27	20.52	16.51	23.48	16.34
25	1.52	10.27	20.56	16.57	23.73	16.39
50	1.53	10.29	20.51	16.65	24.02	16.49
75	1.53	10.30	20.44	16.74	24.12	16.59
100	1.53	10.31	20.35	16.86	24.18	16.67
125	1.53	10.32	20.13	16.92	24.15	16.74
150	1.53	10.32	20.05	16.92	24.13	16.81
175	1.53	10.33	19.80	16.91	24.06	16.88
200	1.53	10.33	19.64	16.91	23.89	17.01
225	1.53	10.34	19.36	16.95	23.79	17.16
250	1.53	10.33	19.26	16.98	23.72	17.25
275	1.52	10.34	18.89	16.99	23.50	17.29
300	1.52	10.33	18.65	17.00	23.22	17.42
325	1.52	10.33	18.46	16.94	22.94	17.59
350	1.51	10.33	18.11	16.89	22.70	17.65
375	1.51	10.33	17.90	16.83	22.52	17.74
400	1.51	10.32	17.66	16.80	22.40	17.88
425	1.51	10.33	17.35	16.83	22.24	17.98
450	1.51	10.32	17.09	16.88	21.86	18.07
475	1.51	10.32	16.91	16.96	21.44	18.11
500	1.51	10.32	16.52	16.93	21.12	18.26
525	1.51	10.31	16.47	16.88	21.01	18.43
550	1.50	10.32	16.00	16.80	20.90	18.50
600	1.51	10.32	15.52	16.83	20.37	18.62
650	1.52	10.32	15.12	17.00	20.30	19.09
700	1.52	10.30	14.82	17.13	20.28	19.07
750	1.53	10.29	14.60	17.21	20.34	19.42
800	1.52	10.27	14.38	17.41	20.44	19.52
850	1.52	10.25	14.13	17.83	20.97	19.65
900	1.53	10.24	13.88	18.14	20.96	20.22
950	1.53	10.23	13.64	18.34	21.39	20.11
1000	1.54	10.22	13.63	18.67	21.65	20.64
1100	1.53	10.16	13.68	19.07	22.78	20.81
1200	1.54	10.15	13.03	19.38	24.14	20.60
1300	1.59	10.17	11.97	18.99	25.25	20.37
1400	1.64	10.16	10.61	18.54	24.98	19.73
1500	1.71	10.12	9.42	17.92	25.12	18.83
1600	1.81	10.11	7.93	17.06	25.31	17.71
1700	1.94	10.15	7.00	16.36	25.27	16.46
1800	2.11	10.15	6.34	15.40	24.57	15.53
1900	2.28	10.22	5.99	14.98	24.49	14.51
2000	2.48	10.30	5.95	14.39	23.76	13.68
2100	2.63	10.48	5.93	14.13	22.24	13.02
2200	2.75	10.74	6.28	13.75	21.08	12.55
2300	2.86	11.00	6.15	13.29	20.04	12.07
2400	2.93	11.29	5.60	12.92	19.32	11.79
2500	3.03	11.49	4.48	12.64	18.73	11.59
2600	3.20	11.63	3.75	12.48	18.31	11.22
2700	3.54	11.51	2.74	12.44	17.84	10.92
2800	3.85	11.51	2.09	12.25	17.63	10.67
2900	4.21	11.53	2.13	11.81	17.37	10.50
3000	4.48	11.58	1.97	11.21	17.57	10.16



# Directional Coupler

# TCD-10-1W-75X+

## Typical Performance Data

TEST CONDITIONS: INPUT POWER =0 dBm @Temperature = -40°C

FREQUENCY (MHz)	INSERTION LOSS (dB)	COUPLING LOSS (dB)	DIRECTIVITY (dB)	RETURN LOSS (dB)		
				IN	OUT	CPL
10	1.53	10.13	19.08	15.43	18.71	15.25
20	1.36	10.03	19.75	17.36	23.06	17.17
25	1.34	10.03	19.95	17.87	24.46	17.66
50	1.29	10.02	20.31	19.11	27.91	18.91
75	1.28	10.03	20.31	19.31	29.51	19.15
100	1.28	10.03	20.27	18.80	30.34	18.65
125	1.28	10.04	20.07	18.41	30.36	18.27
150	1.29	10.04	20.05	18.52	29.97	18.39
175	1.29	10.04	19.81	18.81	29.50	18.80
200	1.29	10.05	19.69	18.69	28.75	18.92
225	1.29	10.04	19.44	18.19	28.07	18.57
250	1.30	10.04	19.29	17.78	27.38	18.16
275	1.30	10.04	18.95	17.73	26.44	18.05
300	1.30	10.04	18.77	17.80	25.52	18.25
325	1.30	10.04	18.60	17.61	24.65	18.36
350	1.30	10.04	18.25	17.20	23.90	18.12
375	1.30	10.04	18.03	16.86	23.30	17.86
400	1.31	10.03	17.82	16.72	22.81	17.83
425	1.31	10.03	17.54	16.74	22.41	17.95
450	1.31	10.03	17.28	16.67	21.80	18.00
475	1.32	10.03	17.11	16.51	21.24	17.86
500	1.32	10.03	16.71	16.35	20.77	17.77
525	1.31	10.02	16.70	16.30	20.56	17.82
550	1.32	10.03	16.23	16.24	20.35	17.88
600	1.32	10.03	15.78	16.12	19.65	17.88
650	1.33	10.01	15.42	16.35	19.36	18.26
700	1.34	10.00	15.19	16.61	19.16	18.43
750	1.34	9.97	15.03	16.88	19.07	18.84
800	1.33	9.94	14.87	17.45	19.15	19.33
850	1.33	9.92	14.72	18.20	19.73	19.76
900	1.34	9.89	14.55	19.31	20.05	20.94
950	1.33	9.87	14.46	20.09	20.70	21.64
1000	1.33	9.84	14.62	20.90	21.40	22.85
1100	1.31	9.76	14.93	20.44	23.30	24.00
1200	1.31	9.72	14.37	18.74	25.85	22.70
1300	1.35	9.73	13.10	16.94	28.11	19.69
1400	1.39	9.71	11.37	15.73	27.23	17.41
1500	1.44	9.67	9.89	15.27	26.04	15.71
1600	1.52	9.65	8.22	15.36	24.35	14.48
1700	1.63	9.68	7.18	15.91	22.30	14.07
1800	1.80	9.69	6.56	17.28	20.20	14.61
1900	1.98	9.74	6.25	19.20	19.36	15.74
2000	2.18	9.82	6.36	19.00	19.02	17.29
2100	2.30	9.96	6.45	16.16	18.99	16.52
2200	2.40	10.27	6.88	13.34	19.87	13.73
2300	2.47	10.54	6.76	10.95	21.01	11.42
2400	2.51	10.85	6.04	9.35	21.92	9.16
2500	2.64	11.08	4.62	8.54	21.13	8.13
2600	2.82	11.26	3.64	8.26	19.59	7.29
2700	3.19	11.17	2.56	8.79	17.94	7.14
2800	3.51	11.28	1.71	9.95	16.66	7.90
2900	3.89	11.33	1.87	11.70	15.37	9.41
3000	4.22	11.54	1.71	14.64	14.71	11.73



# Directional Coupler

# TCD-10-1W-75X+

## Typical Performance Data

TEST CONDITIONS: INPUT POWER =0 dBm @Temperature = +85°C

FREQUENCY (MHz)	INSERTION LOSS (dB)	COUPLING LOSS (dB)	DIRECTIVITY (dB)	RETURN LOSS (dB)		
				IN	OUT	CPL
10	1.80	10.54	20.17	15.04	20.06	14.85
20	1.79	10.53	20.24	15.16	20.75	14.97
25	1.79	10.53	20.21	15.13	20.85	14.94
50	1.79	10.54	20.12	14.84	20.94	14.66
75	1.80	10.55	20.00	14.88	20.92	14.68
100	1.79	10.55	19.91	15.33	20.89	15.08
125	1.79	10.56	19.71	15.77	20.87	15.54
150	1.78	10.57	19.63	15.84	20.98	15.72
175	1.77	10.57	19.33	15.70	21.07	15.68
200	1.77	10.57	19.15	15.69	21.13	15.76
225	1.75	10.57	18.88	16.00	21.26	16.12
250	1.75	10.56	18.75	16.38	21.42	16.55
275	1.74	10.57	18.41	16.58	21.50	16.81
300	1.73	10.56	18.19	16.55	21.55	16.92
325	1.73	10.56	17.98	16.45	21.57	16.98
350	1.72	10.56	17.65	16.52	21.61	17.09
375	1.72	10.56	17.42	16.70	21.71	17.39
400	1.71	10.56	17.21	16.86	21.86	17.78
425	1.71	10.57	16.89	16.97	21.93	18.05
450	1.71	10.57	16.61	17.00	21.76	18.19
475	1.70	10.57	16.38	17.06	21.54	18.22
500	1.70	10.58	16.03	17.13	21.42	18.42
525	1.70	10.57	15.94	17.19	21.50	18.69
550	1.69	10.58	15.48	17.16	21.49	18.82
600	1.69	10.59	14.97	17.11	21.08	18.88
650	1.70	10.60	14.54	17.26	21.16	19.21
700	1.70	10.60	14.21	17.23	21.09	19.20
750	1.70	10.59	13.96	17.10	21.04	19.39
800	1.70	10.58	13.68	17.19	21.02	19.35
850	1.70	10.58	13.40	17.34	21.35	19.31
900	1.70	10.58	13.08	17.46	21.01	19.62
950	1.71	10.59	12.84	17.57	21.31	19.36
1000	1.72	10.58	12.77	17.83	21.26	19.71
1100	1.73	10.54	12.72	18.41	22.04	19.71
1200	1.74	10.55	12.05	19.39	23.05	20.04
1300	1.80	10.59	11.09	19.93	24.16	20.73
1400	1.87	10.58	9.91	20.20	24.50	21.06
1500	1.95	10.55	8.89	19.30	25.67	21.00
1600	2.07	10.54	7.58	17.69	27.26	19.69
1700	2.21	10.57	6.74	16.19	29.58	17.57
1800	2.37	10.58	6.09	14.59	31.30	15.77
1900	2.54	10.64	5.77	13.87	31.67	13.99
2000	2.71	10.71	5.71	13.29	27.74	12.88
2100	2.85	10.88	5.68	13.42	23.91	12.32
2200	2.95	11.10	6.00	13.72	21.39	12.21
2300	3.08	11.33	5.90	14.14	19.96	12.41
2400	3.15	11.56	5.44	14.61	19.12	13.03
2500	3.28	11.70	4.52	14.97	18.92	13.57
2600	3.45	11.79	3.88	14.73	19.15	13.51
2700	3.79	11.62	2.94	14.00	19.25	12.86
2800	4.09	11.55	2.38	12.93	19.38	11.76
2900	4.41	11.52	2.40	11.70	19.00	10.84
3000	4.61	11.50	2.22	10.61	18.74	9.93



# Directional Coupler

## Typical Performance Curves

# TCD-10-1W-75X+

Insertion Loss

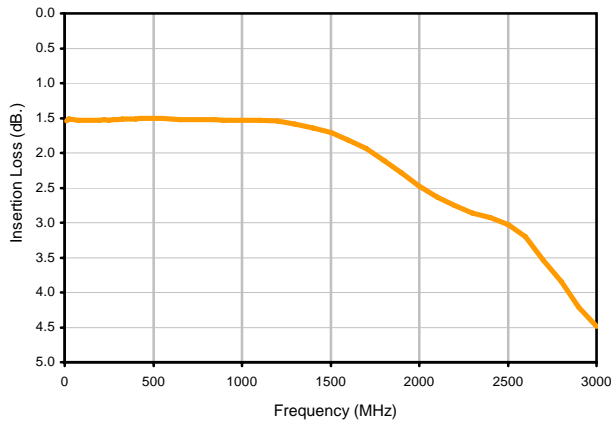

Insertion Loss vs. TEMPERATURE

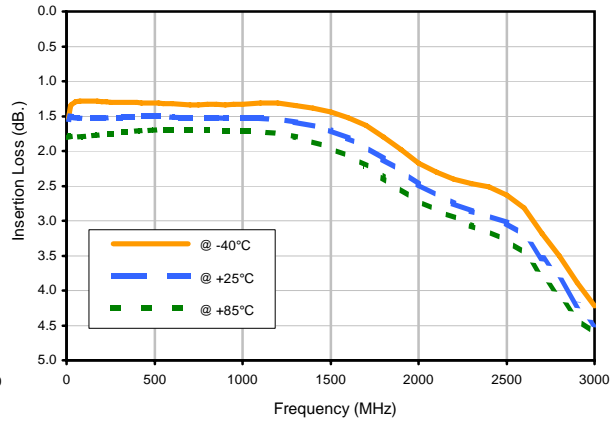

Coupling Loss vs. TEMPERATURE

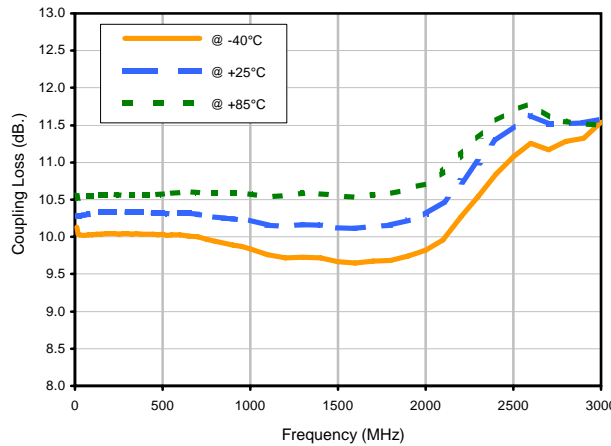

Directivity vs. TEMPERATURE

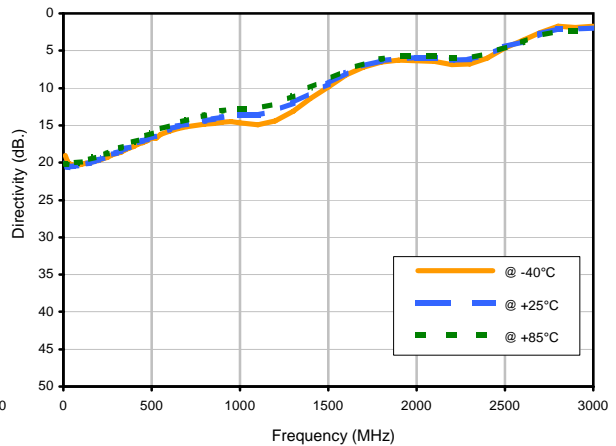

# Directional Coupler

# TCD-10-1W-75X+

## Typical Performance Curves

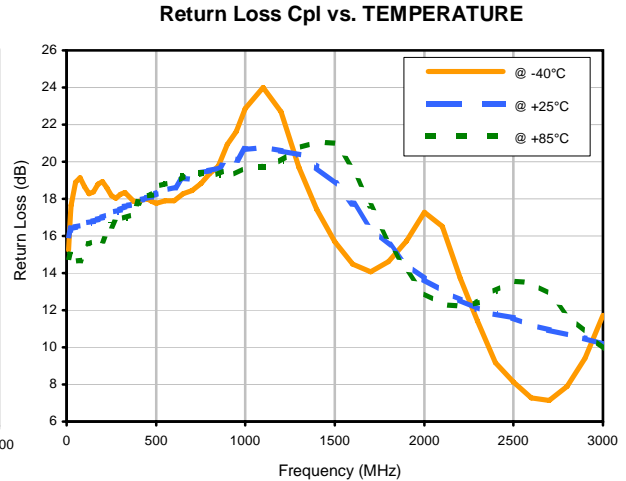
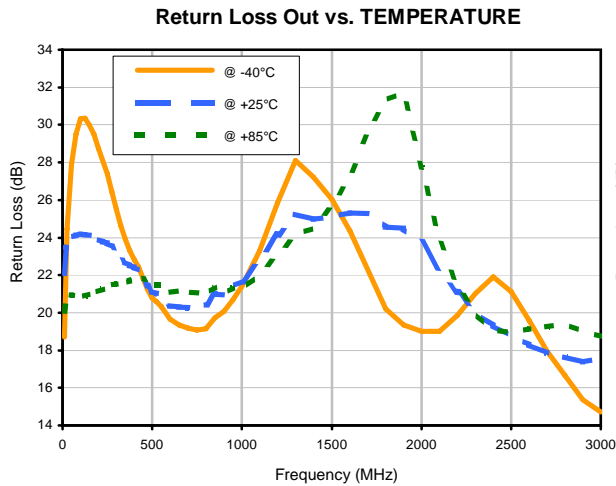
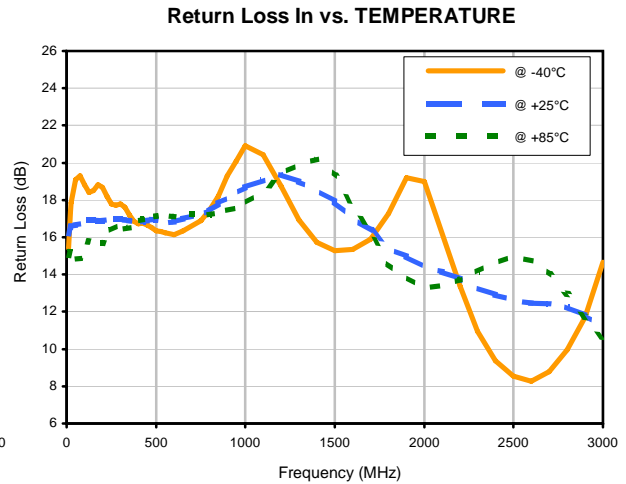



### Outline Dimensions

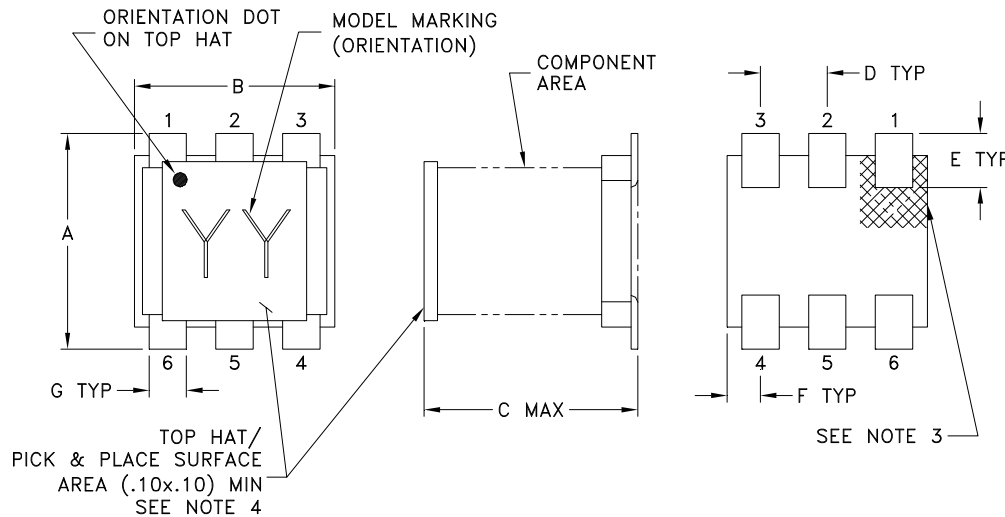

### PCB Land Pattern

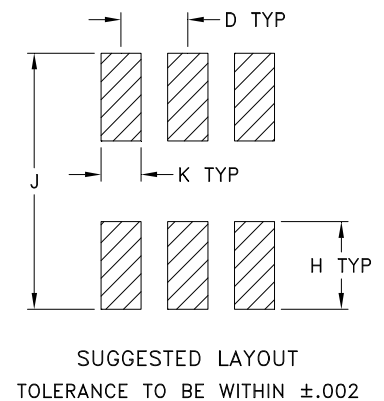

CASE #	A	B	C	D	E	F	G	H	J	K	WT. GRAM
DB1627	.160 (4.06)	.150 (3.81)	.160 (4.06)	.050 (1.27)	.040 (1.02)	.025 (0.64)	.028 (0.71)	.065 (1.65)	.190 (4.83)	.030 (0.76)	.15

Dimensions are in inches (mm). Tolerances: 2 Pl.  $\pm .01$ ; 3Pl.  $\pm .005$

### Notes:

- Case material: Plastic.
- Termination finish:  
For RoHS Case Styles: Tin plate over Nickel plate. All models, (+) suffix.  
For RoHS-5 Case Styles: Tin-Lead plate. All models, no (+) suffix.
- Orientation dot on top hat & orientation feature on substrate correspondence to pin #1.
- Top-Hat total thickness: .013 inches MAX.

# Tape & Reel Packaging TR-F47

## DEVICE ORIENTATION IN T&R

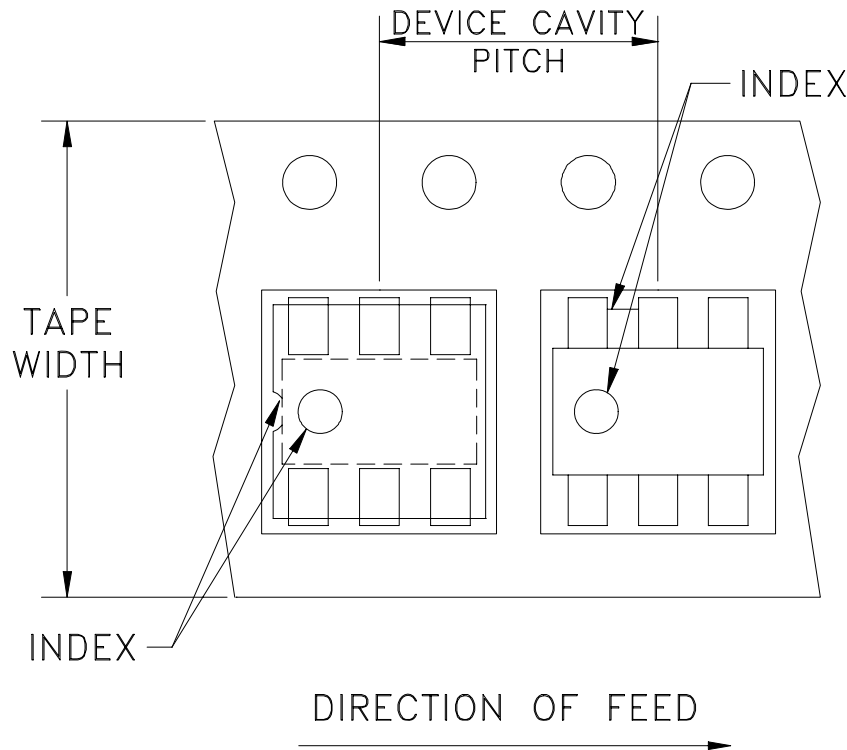

Tape Width, mm	Device Cavity Pitch, mm	Reel Size, inches	Devices per Reel see note
12	8	13	1000, 2000
		7	20, 50, 100, 200, 500

Note: Please consult individual model data sheet to determine device per reel availability.

Mini-Circuits carrier tape materials provide protection from ESD (Electro-Static Discharge) during handling and transportation. Tapes are static dissipative and comply with industry standards EIA-481/EIA-541.

Go to: [www.minicircuits.com/pages/pdfs/tape.pdf](http://www.minicircuits.com/pages/pdfs/tape.pdf)



INTERNET <http://www.minicircuits.com>

P.O. Box 350166, Brooklyn, New York 11235-0003 (718) 934-4500 Fax (718) 332-4661

Distribution Centers NORTH AMERICA 800-654-7949 • 417-335-5935 • Fax 417-335-5945 • EUROPE 44-1252-832600 • Fax 44-1252-837010

Mini-Circuits ISO 9001 & ISO 14001 Certified

THIRD ANGLE PROJECTION

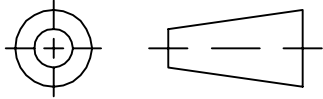

REVISIONS

REV	ECN No.	DESCRIPTION	DATE	DR	AUTH
OR	M73159	NEW RELEASE	08/00	IL	DB
A	M82377	UPDATED DRAWING	07/30/02	AV	LC
B	M102713	UPDATED NOTES	01/12/08	GF	IL

SUGGESTED MOUNTING CONFIGURATION FOR  
DB714 CASE STYLE, "mm" PIN CONNECTION

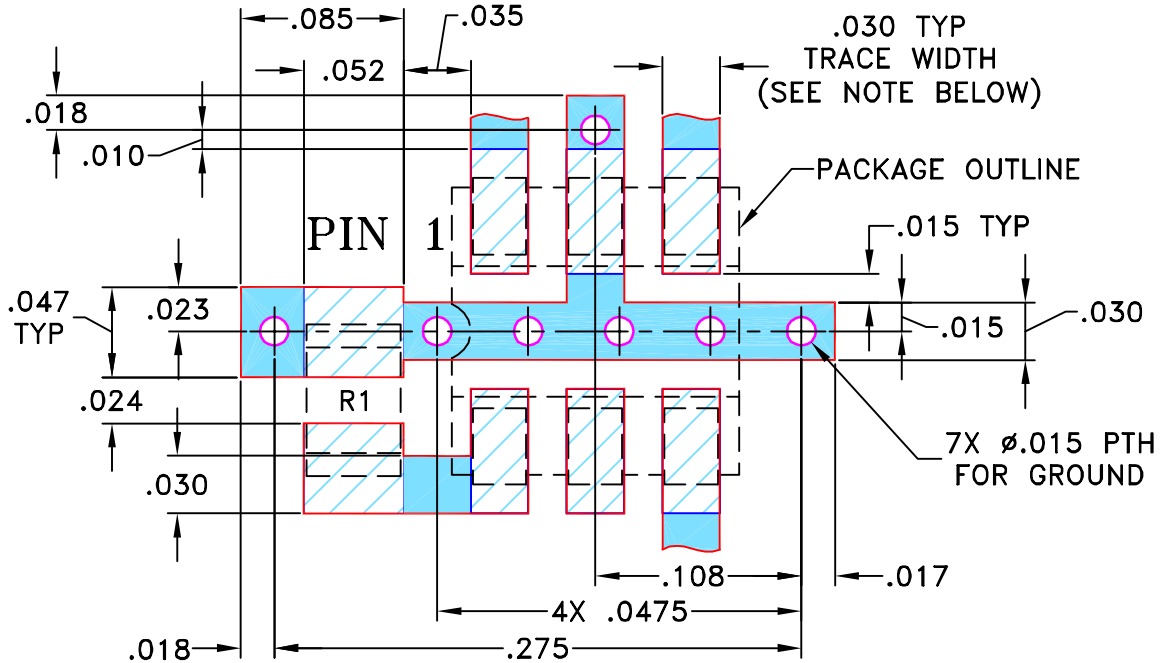

RESISTOR R1: 75 ± 1% Ohm, 0805 SIZE

- NOTES: 1. TRACE WIDTH IS SHOWN FOR ROGERS RO4350B WITH DIELECTRIC THICKNESS 0.030" ± 0.002"; COPPER: 1/2 OZ. EACH SIDE. FOR OTHER MATERIALS TRACE WIDTH MAY NEED TO BE MODIFIED.
2. BOTTOM SIDE OF THE PCB IS CONTINUOUS GROUND PLANE.



DENOTES PCB COPPER LAYOUT WITH SMOBC (SOLDER MASK OVER BARE COPPER)



DENOTES COPPER LAND PATTERN FREE OF SOLDER MASK

UNLESS OTHERWISE SPECIFIED

INITIALS DATE

DIMENSIONS ARE IN INCHES  
TOLERANCES ON:  
2 PL DECIMALS ±  
3 PL DECIMALS ± .005  
ANGLES ±  
FRACTIONS ±

	INITIALS	DATE
DRAWN	IL	08/03/00
CHECKED	WP	08/08/00
APPROVED	DB	08/09/00



Mini-Circuits® 13 Neptune Avenue  
Brooklyn NY 11235

PL, mm, 75, DB714, TCD, TB-72

Mini-Circuits®  
THIS DOCUMENT AND ITS CONTENTS ARE THE PROPERTY OF MINI-CIRCUITS. EXCEPT FOR USE EXPRESSLY GRANTED, IN WRITING, TO ITS VENDORS, VENDEE AND THE UNITED STATES GOVERNMENT, MINI-CIRCUITS RESERVES ALL PROPRIETARY DESIGN, USE, MANUFACTURING AND REPRODUCTION RIGHTS THERETO. THESE CONTENTS SHALL NOT BE USED, DUPLICATED OR DISCLOSED TO ANY OUTSIDE PARTY, IN WHOLE OR IN PART, WITHOUT WRITTEN PERMISSION OF MINI-CIRCUITS.

SIZE	CODE IDENT	DRAWING NO:	REV:
A	15542	98-PL-010	B
FILE:	98PL010	SCALE:	10:1
		SHEET:	1 OF 1

# Evaluation Board and Circuit

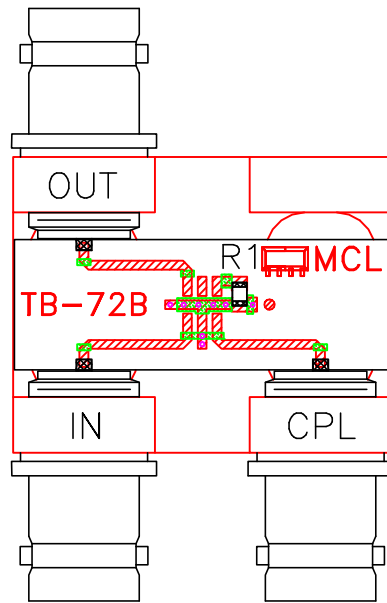

TB-72

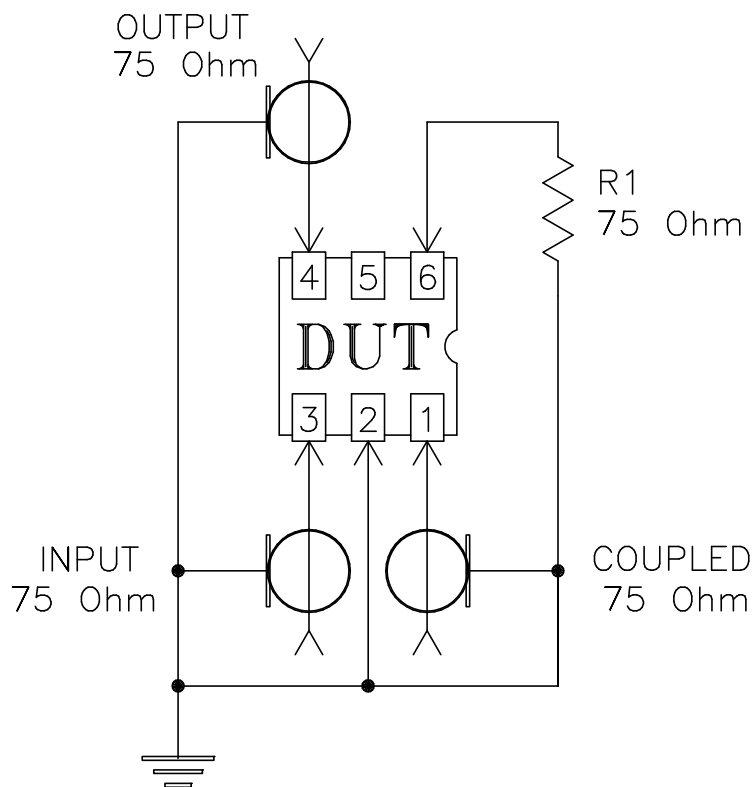

Schematic Diagram

## Notes:

1. 75 Ohm BNC Female connectors.
2. PCB Material: Rogers R04350 or equivalent,  
Dielectric Constant=3.5, Thickness=.030 inch.

 **Mini-Circuits®**



All Mini-Circuits products are manufactured under exacting quality assurance and control standards, and are capable of meeting published specifications after being subjected to any or all of the following physical and environmental test.

Specification	Test/Inspection Condition	Reference/Spec
Operating Temperature	-40° to 85°C Ambient Environment	Individual Model Data Sheet
Storage Temperature	-55° to 100° C Ambient Environment	Individual Model Data Sheet
Humidity	90 to 95% RH, 240 hours, 50°C	MIL-STD-202, Method 103, Condition A, Except 50°C and end-point electrical test done within 12 hours
Thermal Shock	-55° to 100°C, 100 cycles	MIL-STD-202, Method 107, Condition A-3, except +100°C
Solder Reflow Heat	Sn-Pb Eutetic Process: 225°C peak Pb-Free Process 245° - 250°C peak	J-STD-020, Table 4-1, 4-2 and 5-2, Figure 5-1
Solderability	10X Magnification	J-STD-002, 95% Coverage
Vibration (High Frequency)	20g peak, 10-2000 Hz, 12 times in each of three perpendicular directions (total 36)	MIL-STD-202, Method 204, Condition D
Mechanical Shock	50g, 11 ms, 1/2-sine, 18 shocks: 3 each direction, each of 3 axes	MIL-STD-202, Method 213, Condition A
Marking Resistance to Solvents	Isopropyl alcohol + mineral spirits at 25°C; terpene defluxer at 25°C; distilled water + proylene glycol monomethyl ether + monoethanolamine at 63°C to 70°C	MIL-STD-202, Method 215