



SURFACE MOUNT

RF Transformer

TC4-25+

TC4-25X+
Upgraded Version*

50Ω 500 to 2500 MHz

- *Addition of Top Hat® feature Benefits**
- Allows faster pick-and-place
 - Enables visual identification marking

FEATURES

- Wideband, 500-2500 MHz
- Balanced transmission line with secondary center tap
- Good return loss
- Plastic base with leads
- Aqueous washable



Generic photo used for illustration purposes only

CASE STYLE: AT224-1A

+RoHS Compliant

The +Suffix identifies RoHS Compliance.
See our website for methodologies and qualifications

APPLICATIONS

- PCS
- Cellular

ELECTRICAL SPECIFICATIONS AT 25°C

| Parameter | Condition | Min. | Typ. | Max. | Unit |
|---------------------------------------|-----------|------|------|------|------|
| Impedance Ratio (secondary / primary) | | | 4 | | |
| Frequency Range | | 500 | | 2500 | MHz |
| Insertion Loss* | 500-2500 | | 3.0 | | dB |
| | 700-1500 | | 2.0 | | |
| | 750-1200 | | 1.0 | | |

* Insertion Loss is referenced to mid-band loss, 0.2 dB typ.

MAXIMUM RATINGS

| Parameter | Ratings |
|-----------------------|----------------|
| Operating Temperature | -40°C to 85°C |
| Storage Temperature | -55°C to 100°C |
| RF Power | 0.25W |
| DC Current | 30mA |

Permanent damage may occur if any of these limits are exceeded.

CONFIG. H

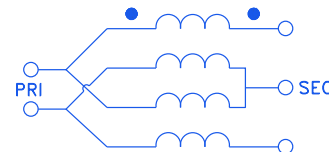

REV. C
ECO-015303
TC4-25+
MCL NY
220913





SURFACE MOUNT

RF Transformer

TC4-25+

Mini-Circuits

50Ω 500 to 2500 MHz

PIN CONNECTIONS

| | |
|---------------|---|
| PRIMARY DOT | 6 |
| PRIMARY | 4 |
| SECONDARY DOT | 3 |
| SECONDARY | 1 |
| SECONDARY CT | 2 |

PRODUCT MARKING: NA

OUTLINE DRAWING

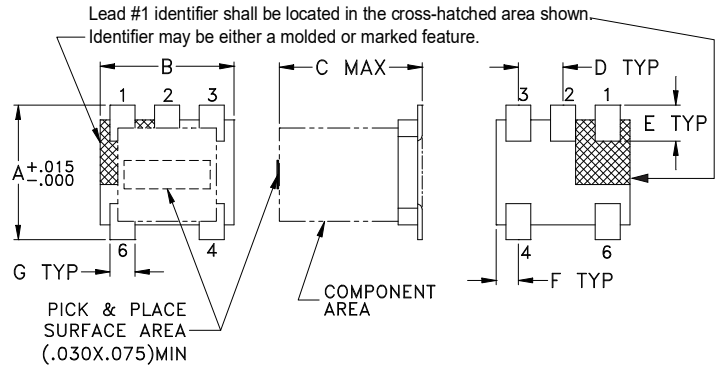

PCB Land Pattern

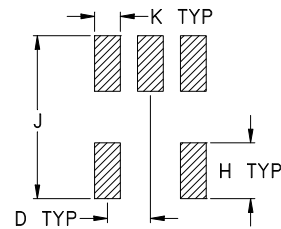

Suggested Layout,
Tolerance to be within ±.002

OUTLINE DIMENSIONS (Inch/mm)

| A | B | C | D | E | F |
|------|------|------|------|-------|------|
| .150 | .150 | .160 | .050 | .040 | .025 |
| 3.81 | 3.81 | 4.06 | 1.27 | 1.02 | 0.64 |
| G | H | J | K | wt | |
| .028 | .065 | .190 | .030 | grams | |
| 0.71 | 1.65 | 4.83 | 0.76 | 0.15 | |

TAPE & REEL INFORMATION: F17



SURFACE MOUNT

RF Transformer

TC4-25+

50Ω 500 to 2500 MHz

TYPICAL PERFORMANCE DATA

| FREQUENCY (MHz) | INSERTION LOSS (dB) | INPUT R. LOSS (dB) |
|-----------------|---------------------|--------------------|
| 500.00 | 1.07 | 8.37 |
| 1000.00 | 0.37 | 22.67 |
| 1500.00 | 0.59 | 13.79 |
| 1600.00 | 0.64 | 12.90 |
| 1800.00 | 0.74 | 11.65 |
| 2000.00 | 0.84 | 10.75 |
| 2200.00 | 0.96 | 10.03 |
| 2400.00 | 1.08 | 9.35 |
| 2500.00 | 1.14 | 8.96 |
| 2800.00 | 1.38 | 7.82 |
| 3000.00 | 1.59 | 7.06 |

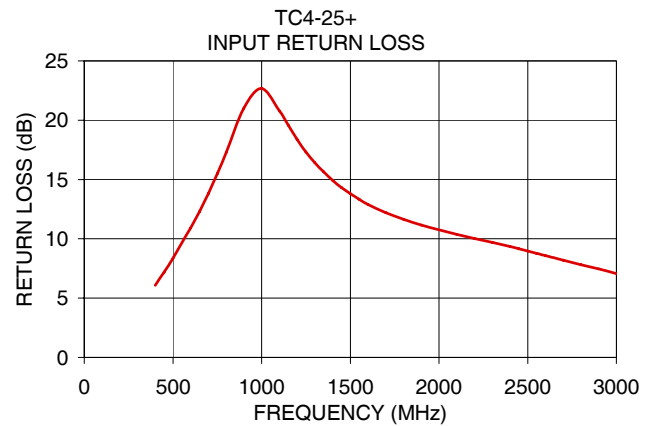

NOTES

- A. Performance and quality attributes and conditions not expressly stated in this specification document are intended to be excluded and do not form a part of this specification document.
- B. Electrical specifications and performance data contained in this specification document are based on Mini-Circuit's applicable established test performance criteria and measurement instructions.
- C. The parts covered by this specification document are subject to Mini-Circuits standard limited warranty and terms and conditions (collectively, "Standard Terms"); Purchasers of this part are entitled to the rights and benefits contained therein. For a full statement of the standard terms and the exclusive rights and remedies thereunder, please visit Mini-Circuits' website at www.minicircuits.com/terms/viewterm.html



RF Transformer

TC4-25+

Typical Performance Data

| FREQUENCY (MHz) | INSERTION LOSS (dB) | RETURN LOSS (dB) |
|--------------------|---------------------------|------------------------|
| 400 | 1.66 | 6.09 |
| 500 | 1.07 | 8.37 |
| 600 | 0.74 | 10.92 |
| 700 | 0.54 | 13.81 |
| 800 | 0.42 | 17.29 |
| 900 | 0.38 | 21.02 |
| 1000 | 0.37 | 22.67 |
| 1100 | 0.40 | 20.79 |
| 1200 | 0.43 | 18.40 |
| 1300 | 0.48 | 16.41 |
| 1400 | 0.53 | 14.94 |
| 1500 | 0.59 | 13.79 |
| 1600 | 0.64 | 12.90 |
| 1800 | 0.74 | 11.65 |
| 2000 | 0.84 | 10.75 |
| 2200 | 0.96 | 10.03 |
| 2400 | 1.08 | 9.35 |
| 2500 | 1.14 | 8.96 |
| 2800 | 1.38 | 7.82 |
| 3000 | 1.59 | 7.06 |

Typical Performance Curves

Insertion Loss

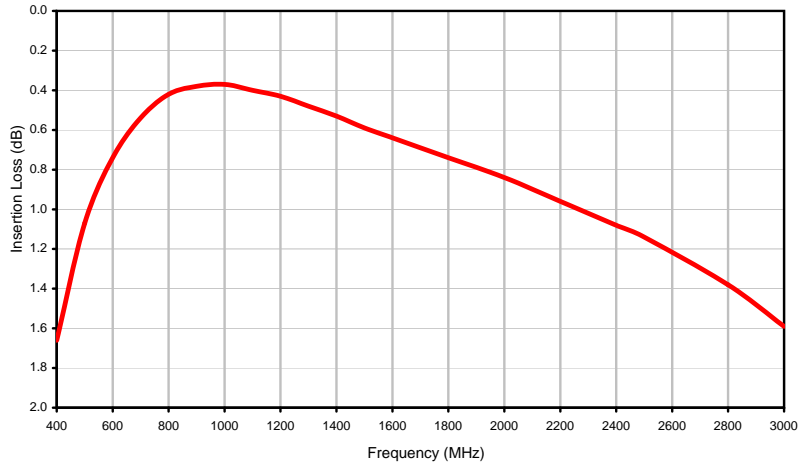

Return Loss

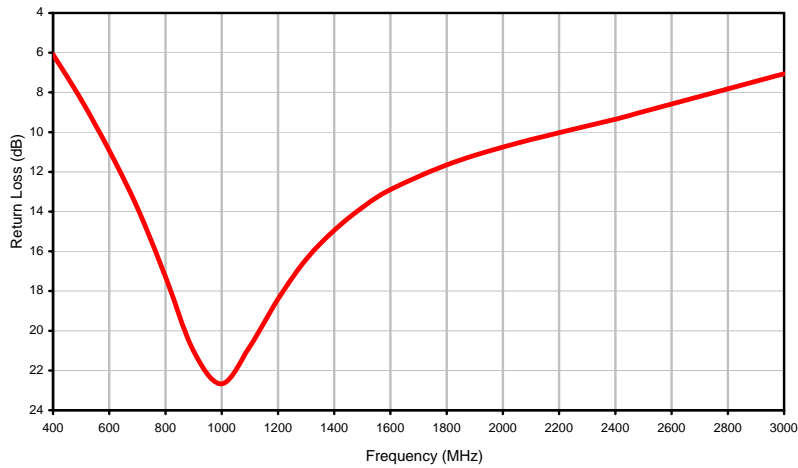

Outline Dimensions

AT224-1A

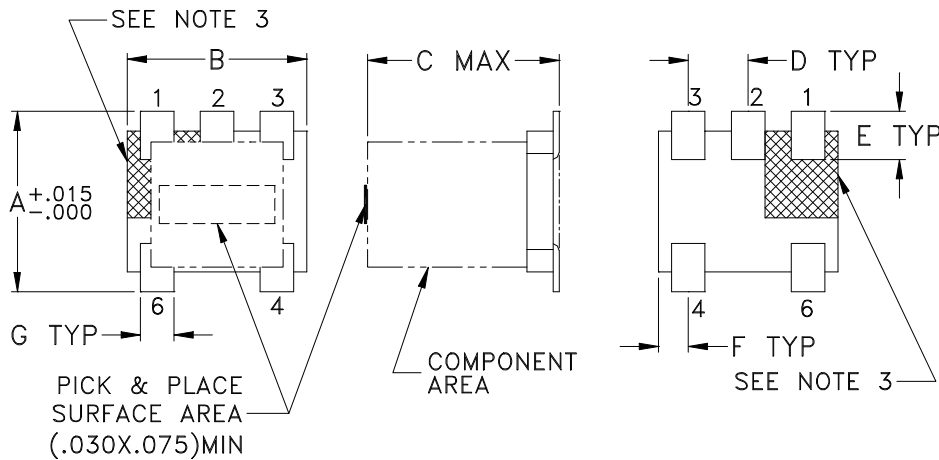

PCB Land Pattern

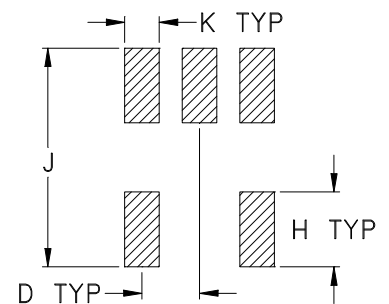

Suggested Layout,
Tolerance to be within $\pm .002$

| CASE # | A | B | C | D | E | F | G | H | J | K | WT. GRAMS |
|----------|----------------|----------------|----------------|----------------|----------------|----------------|----------------|----------------|----------------|----------------|-----------|
| AT224-1A | .150 (3.81) | .150 (3.81) | .160 (4.06) | .050 (1.27) | .040 (1.02) | .025 (0.64) | .028 (0.71) | .065 (1.65) | .190 (4.83) | .030 (0.76) | .15 |

Dimensions are in inches (mm). Tolerances: 2 Pl. $\pm .01$; 3 Pl. $\pm .005$

Notes:

1. Case material: Plastic.
2. Termination finish:
For RoHS Case Styles: Tin plate over Nickel plate. All models, (+) suffix.
3. Lead #1 identifier shall be located in the cross-hatched area shown.
Identifier may be either a molded or marked feature.



P.O. Box 350166, Brooklyn, New York 11235-0003 (718) 934-4500 Fax (718) 332-4661 For detailed performance specs & shopping online see Mini-Circuits web site



The Design Engineers Search Engine Provides ACTUAL Data Instantly From MINI-CIRCUITS At: www.minicircuits.com

RF/MICROWAVE COMPONENTS

Tape & Reel Packaging TR-F17

DEVICE ORIENTATION IN T&R



| Tape Width, mm | Device Cavity Pitch, mm | Reel Size, inches | Devices per Reel | |
|----------------|-------------------------|-------------------|-------------------------------------|------|
| 12 | 8 | 7 | Small quantity standards (see note) | 20 |
| | | | | 50 |
| | | | | 100 |
| | | | | 200 |
| | | | | 500 |
| | | 13 | Standard | 1000 |
| | | 2000 | | |

Note: Please Consult individual model data sheet to determine device per reel availability.

Mini-Circuits carrier tape materials provide protection from ESD (Electro-Static Discharge) during handling and transportation. Tapes are static dissipative and comply with industry standards EIA-481/EIA-541.

Go to: www.minicircuits.com/pages/pdfs/tape.pdf



P.O. Box 350166, Brooklyn, New York 11235-0003 (718) 934-4500 Fax (718) 332-4661 For detailed performance specs & shopping online see Mini-Circuits web site



The Design Engineers Search Engine Provides ACTUAL Data Instantly From MINI-CIRCUITS At: www.minicircuits.com

RF/IF MICROWAVE COMPONENTS

THIRD ANGLE PROJECTION



REVISIONS

| REV | ECN No. | DESCRIPTION | DATE | DR | AUTH |
|-----|---------|-------------|----------|----|------|
| OR | M106563 | NEW RELEASE | 08/23/06 | AV | IG |
| | | | | | |
| | | | | | |

**SUGGESTED MOUNTING CONFIGURATION
FOR AT224/DB714 CASE STYLE, "gs/ha/hd" PIN CONNECTIONS
(FOR SINGLE ENDED TO BALANCED APPLICATION)**



- NOTES:**
- TRACE WIDTH IS SHOWN FOR ROGERS RO4350B WITH DIELECTRIC THICKNESS .020" ± .0015"; COPPER: 1/2 OZ. ON EACH SIDE. FOR OTHER MATERIALS TRACE WIDTH MAY NEED TO BE MODIFIED.
 - BOTTOM SIDE OF THE PCB IS CONTINUOUS GROUND PLANE.
 - THIS PAD IS NOT REQUIRED FOR AT224 CASE STYLE.



DENOTES PCB COPPER LAYOUT WITH SMOBC (SOLDER MASK OVER BARE COPPER)
DENOTES COPPER LAND PATTERN FREE OF SOLDER MASK

UNLESS OTHERWISE SPECIFIED

INITIALS

DATE

DIMENSIONS ARE IN INCHES

DRAWN

AV

07/28/06

TOLERANCES ON:

CHECKED

IL

08/23/06

2 PL DECIMALS ± .005

APPROVED

IG

08/23/06

ANGLES ±

FRACTIONS ±

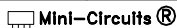

THIS DOCUMENT AND ITS CONTENTS ARE THE PROPERTY OF MINI-CIRCUITS. EXCEPT FOR USE EXPRESSLY GRANTED, IN WRITING, TO ITS VENDORS, VENDEE AND THE UNITED STATES GOVERNMENT, MINI-CIRCUITS RESERVES ALL PROPRIETARY DESIGN, USE, MANUFACTURING AND REPRODUCTION RIGHTS THERETO. THESE CONTENTS SHALL NOT BE USED, DUPLICATED OR DISCLOSED TO ANY OUTSIDE PARTY, IN WHOLE OR IN PART, WITHOUT WRITTEN PERMISSION OF MINI-CIRCUITS.

ASHEETA1.DWG REV:A DATE:01/12/95



Mini-Circuits®

13 Neptune Avenue
Brooklyn NY 11235

PL, gs/ha/hd, AT224/DB714, TC/TCM, TB-145

| | | | |
|-----------|---------------------|--------------------------|------------|
| SIZE A | CODE IDENT 15542 | DRAWING NO: 98-PL-244 | REV: OR |
|-----------|---------------------|--------------------------|------------|

| | | |
|------------------|---------------|------------------|
| FILE: 98PL244 | SCALE: 8:1 | SHEET: 1 OF 1 |
|------------------|---------------|------------------|

Evaluation Board and Circuit

For Pin Connections refer to Data Sheet of the DUT



TB-145

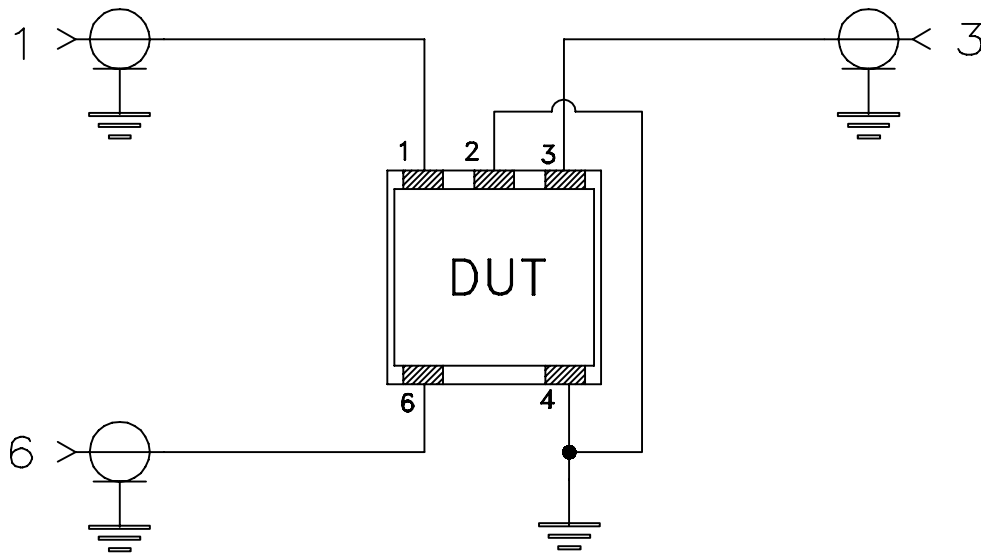

Schematic Diagram

Notes:

1. 50 Ohm SMA Female connectors.
2. PCB Material: Rogers RO4350B or its equivalent, Dielectric Constant=3.5, Thickness=.020"

 **Mini-Circuits®**

All Mini-Circuits products are manufactured under exacting quality assurance and control standards, and are capable of meeting published specifications after being subjected to any or all of the following physical and environmental test.

| Specification | Test/Inspection Condition | Reference/Spec |
|--------------------------------|---|--|
| Operating Temperature | -40° to 85°C Ambient Environment | Individual Model Data Sheet |
| Storage Temperature | -55° to 100° C Ambient Environment | Individual Model Data Sheet |
| Humidity | 90 to 95% RH, 240 hours, 50°C | MIL-STD-202, Method 103, Condition A, Except 50°C and end-point electrical test done within 12 hours |
| Thermal Shock | -55° to 100°C, 100 cycles | MIL-STD-202, Method 107, Condition A-3, except +100°C |
| Solder Reflow Heat | Sn-Pb Eutetic Process: 225°C peak Pb-Free Process 245° - 250°C peak | J-STD-020, Table 4-1, 4-2 and 5-2, Figure 5-1 |
| Solderability | 10X Magnification | J-STD-002, 95% Coverage |
| Vibration (High Frequency) | 20g peak, 10-2000 Hz, 12 times in each of three perpendicular directions (total 36) | MIL-STD-202, Method 204, Condition D |
| Mechanical Shock | 50g, 11 ms, 1/2-sine, 18 shocks: 3 each direction, each of 3 axes | MIL-STD-202, Method 213, Condition A |
| Marking Resistance to Solvents | Isopropyl alcohol + mineral spirits at 25°C; terpene defluxer at 25°C; distilled water + proylene glycol monomethyl ether + monoethanolamine at 63°C to 70°C | MIL-STD-202, Method 215 |