

Surface Mount RF Transformer

50Ω 4.5 to 3000 MHz

TC1-1-13M+



Generic photo used for illustration purposes only

CASE STYLE: AT224-1A

+RoHS Compliant

The +Suffix identifies RoHS Compliance. See our web site for RoHS Compliance methodologies and qualifications

Available Tape and Reel at no extra cost

Reel Size	Devices/Reel
7"	20, 50, 100, 200, 500
13"	1000, 2000

Features

- wideband, 4.5 to 3000 MHz
- balanced transmission line
- good return loss
- excellent amplitude unbalance, 0.5 dB typ. and phase unbalance, 2 deg typ. in 1 dB bandwidth
- plastic base with leads
- aqueous washable

Applications

- balanced to unbalanced transformation
- push-pull amplifiers
- PCS/DCS
- MMDS

Electrical Specifications at 25°C

Parameter	Frequency (MHz)	Min.	Typ.	Max.	Unit
Impedance Ratio			1		
Frequency Range		4.5		3000	MHz
Insertion Loss*	2000-3000		3		dB
	1000-2000		2		
	4.5-1000		1		
Phase Unbalance	4.5-1000		2		Deg.
	1000-2000		3		
Amplitude Unbalance	4.5-1000		0.5		dB
	1000-2000		0.5		

*Insertion Loss is referenced to mid-band loss, 0.5 dB typ.

Maximum Ratings

Parameter	Ratings
Operating Temperature	-40°C to 85°C
Storage Temperature	-55°C to 100°C
RF Power	0.25W
DC Current	30mA

Permanent damage may occur if any of these limits are exceeded.

Pin Connections

Function	Pin Number
PRIMARY DOT	6
PRIMARY	4
SECONDARY DOT	1
SECONDARY	3
NOT USED	2

Config. G

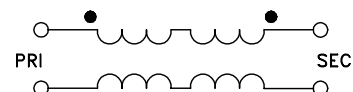

Outline Drawing

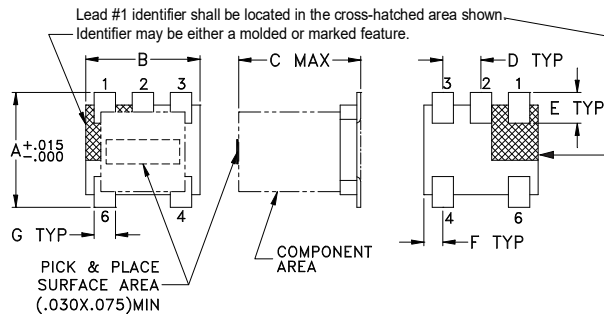

PCB Land Pattern

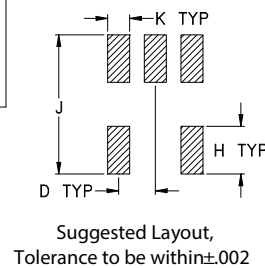

Outline Dimensions (inch/mm)

A	B	C	D	E	F
.150	.150	.160	.050	.040	.025
3.81	3.81	4.06	1.27	1.02	0.64
G	H	J	K	wt	
.028	.065	.190	.030	grams	
0.71	1.65	4.83	0.76	0.15	

Typical Performance Data

FREQUENCY (MHz)	INSERTION LOSS (dB)	INPUT R. LOSS (dB)	AMPLITUDE UNBALANCE (dB)	PHASE UNBALANCE (Deg.)
4.50	0.18	31.52	0.69	3.81
10.00	0.18	34.60	0.56	1.78
50.00	0.19	33.50	0.56	0.11
100.00	0.24	29.68	0.55	0.19
500.00	0.46	19.52	0.45	0.81
1000.00	0.68	16.22	0.14	1.59
1500.00	0.90	15.89	0.29	0.89
2000.00	1.11	16.97	0.71	1.28
2500.00	1.62	12.88	0.78	5.79
3000.00	3.02	6.79	0.49	12.32

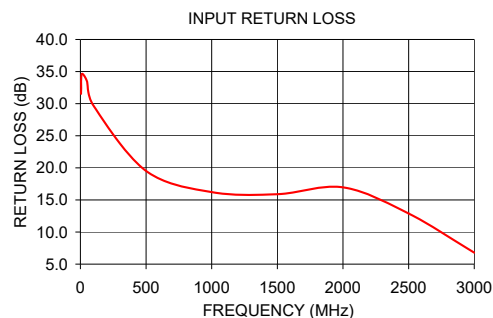

Additional Notes

- Performance and quality attributes and conditions not expressly stated in this specification document are intended to be excluded and do not form a part of this specification document.
- Electrical specifications and performance data contained in this specification document are based on Mini-Circuit's applicable established test performance criteria and measurement instructions.
- The parts covered by this specification document are subject to Mini-Circuits standard limited warranty and terms and conditions (collectively, "Standard Terms"); Purchasers of this part are entitled to the rights and benefits contained therein. For a full statement of the Standard Terms and the exclusive rights and remedies thereunder, please visit Mini-Circuits' website at www.minicircuits.com/MCLStore/terms.jsp

RF Transformer

TC1-1-13M+

Typical Performance Data

FREQUENCY (MHz)	AVERAGE INSERTION LOSS (dB)	INPUT RETURN LOSS (dB)	AMPLITUDE UNBALANCE (dB)	PHASE UNBALANCE (deg)
4.5	0.18	31.52	0.69	3.81
10.0	0.18	34.60	0.56	1.78
50.0	0.19	33.50	0.56	0.11
100.0	0.24	29.68	0.55	0.19
500.0	0.46	19.52	0.45	0.81
1000.0	0.68	16.22	0.14	1.59
1500.0	0.90	15.89	0.29	0.89
2000.0	1.11	16.97	0.71	1.28
2500.0	1.62	12.88	0.78	5.79
3000.0	3.02	6.79	0.49	12.32

Typical Performance Curves

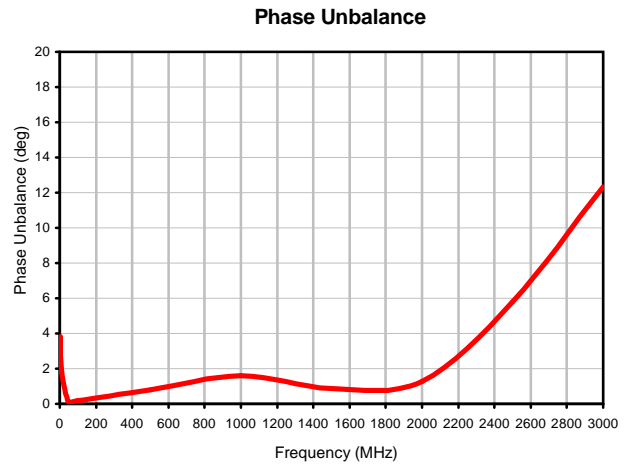
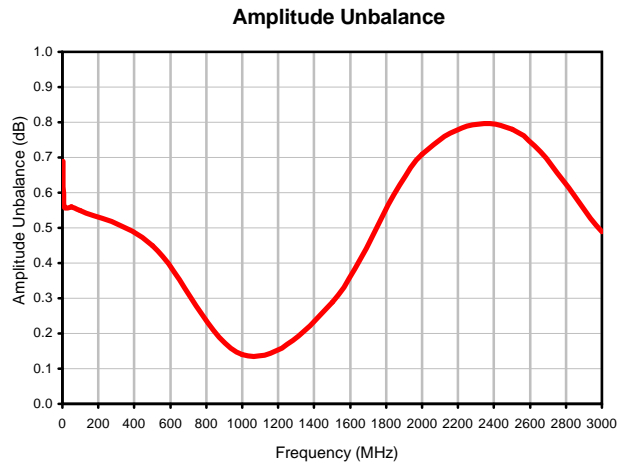
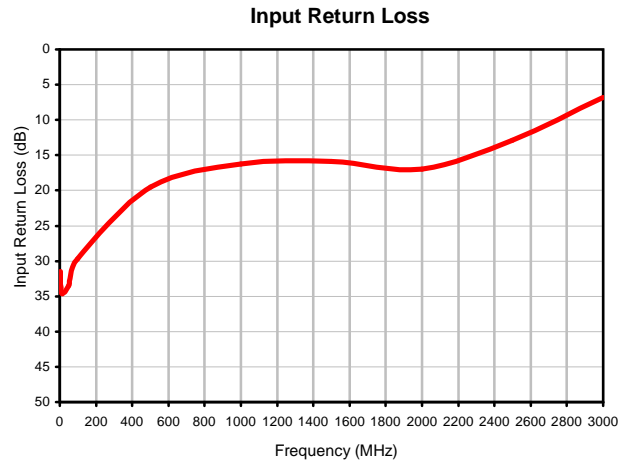

Outline Dimensions

AT224-1A

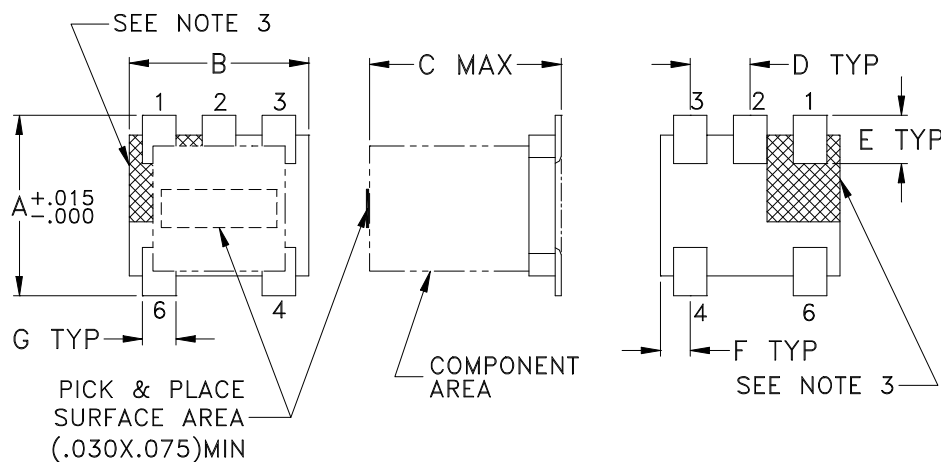

PCB Land Pattern

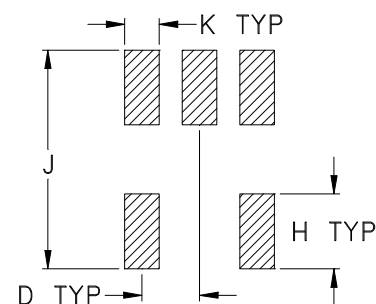

Suggested Layout,
Tolerance to be within $\pm.002$

CASE #	A	B	C	D	E	F	G	H	J	K	WT. GRAMS
AT224-1A	.150 (3.81)	.150 (3.81)	.160 (4.06)	.050 (1.27)	.040 (1.02)	.025 (0.64)	.028 (0.71)	.065 (1.65)	.190 (4.83)	.030 (0.76)	.15

Dimensions are in inches (mm). Tolerances: 2 Pl. $\pm .01$; 3 Pl. $\pm .005$

Notes:

- Case material: Plastic.
- Termination finish:
For RoHS Case Styles: Tin plate over Nickel plate. All models, (+) suffix.
- Lead #1 identifier shall be located in the cross-hatched area shown.
Identifier may be either a molded or marked feature.



P.O. Box 350166, Brooklyn, New York 11235-0003 (718) 934-4500 Fax (718) 332-4661 For detailed performance specs & shopping online see Mini-Circuits web site



The Design Engineers Search Engine Provides ACTUAL Data Instantly From MINI-CIRCUITS At: www.minicircuits.com

RF/MICROWAVE COMPONENTS

Tape & Reel Packaging TR-F17

DEVICE ORIENTATION IN T&R

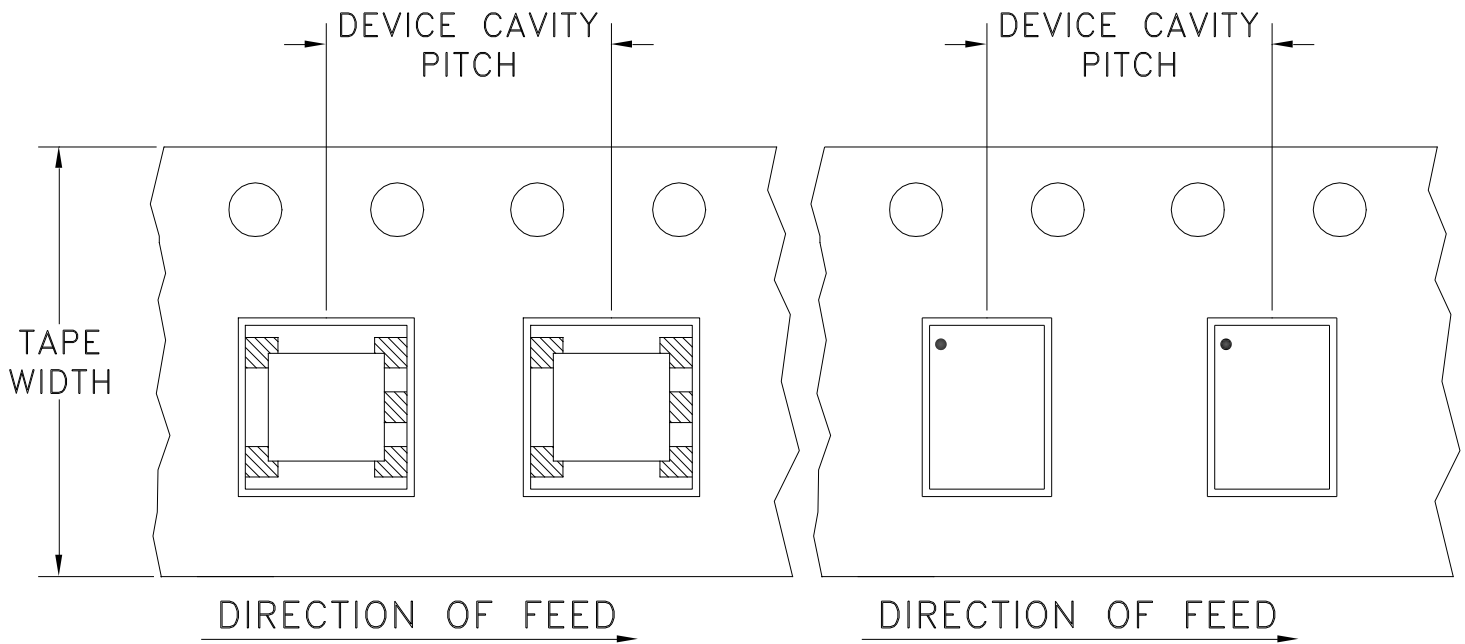

Tape Width, mm	Device Cavity Pitch, mm	Reel Size, inches	Devices per Reel	
12	8	7	Small quantity standards (see note)	20
				50
				100
				200
				500
		13	Standard	1000
2000				

Note: Please Consult individual model data sheet to determine device per reel availability.

Mini-Circuits carrier tape materials provide protection from ESD (Electro-Static Discharge) during handling and transportation. Tapes are static dissipative and comply with industry standards EIA-481/EIA-541.

Go to: www.minicircuits.com/pages/pdfs/tape.pdf



P.O. Box 350166, Brooklyn, New York 11235-0003 (718) 934-4500 Fax (718) 332-4661 For detailed performance specs & shopping online see Mini-Circuits web site



The Design Engineers Search Engine Provides ACTUAL Data Instantly From MINI-CIRCUITS At: www.minicircuits.com

RF/IF MICROWAVE COMPONENTS

THIRD ANGLE PROJECTION

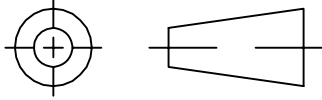

REVISIONS

REV	ECN No.	DESCRIPTION	DATE	DR	AUTH
OR	M106563	NEW RELEASE	08/23/06	AV	IG

SUGGESTED MOUNTING CONFIGURATION
FOR AT224/DB714 CASE STYLE, "gs/ha/hd" PIN CONNECTIONS
(FOR SINGLE ENDED TO BALANCED APPLICATION)

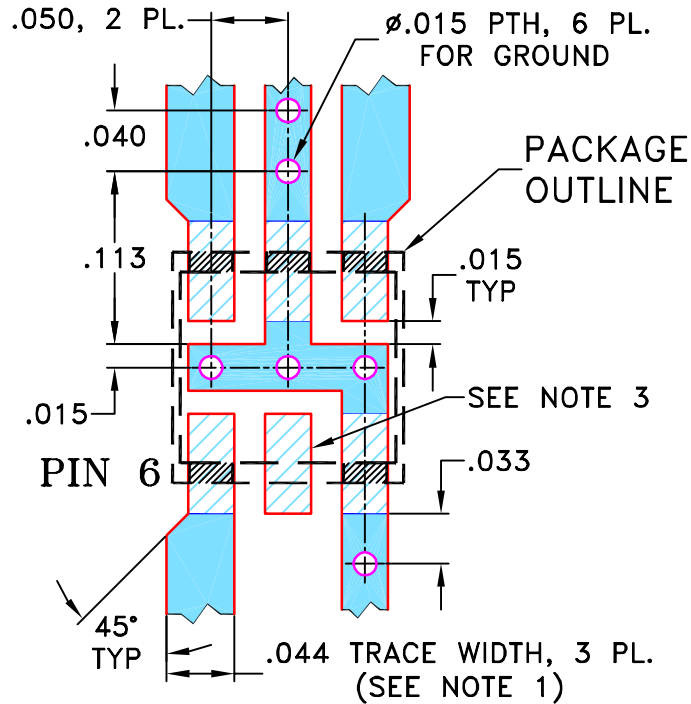

- NOTES:**
- TRACE WIDTH IS SHOWN FOR ROGERS RO4350B WITH DIELECTRIC THICKNESS .020" ± .0015"; COPPER: 1/2 OZ. ON EACH SIDE. FOR OTHER MATERIALS TRACE WIDTH MAY NEED TO BE MODIFIED.
 - BOTTOM SIDE OF THE PCB IS CONTINUOUS GROUND PLANE.
 - THIS PAD IS NOT REQUIRED FOR AT224 CASE STYLE.

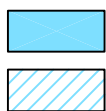

DENOTES PCB COPPER LAYOUT WITH SMOBC (SOLDER MASK OVER BARE COPPER)
 DENOTES COPPER LAND PATTERN FREE OF SOLDER MASK

UNLESS OTHERWISE SPECIFIED

INITIALS DATE

DIMENSIONS ARE IN INCHES
 TOLERANCES ON:
 2 PL DECIMALS ±
 3 PL DECIMALS ± .005
 ANGLES ±
 FRACTIONS ±

DRAWN	AV	07/28/06
CHECKED	IL	08/23/06
APPROVED	IG	08/23/06



Mini-Circuits®

13 Neptune Avenue
 Brooklyn NY 11235

PL, gs/ha/hd, AT224/DB714, TC/TCM, TB-145

THIS DOCUMENT AND ITS CONTENTS ARE THE PROPERTY OF MINI-CIRCUITS. EXCEPT FOR USE EXPRESSLY GRANTED, IN WRITING, TO ITS VENDORS, VENDEE AND THE UNITED STATES GOVERNMENT, MINI-CIRCUITS RESERVES ALL PROPRIETARY DESIGN, USE, MANUFACTURING AND REPRODUCTION RIGHTS THERETO. THESE CONTENTS SHALL NOT BE USED, DUPLICATED OR DISCLOSED TO ANY OUTSIDE PARTY, IN WHOLE OR IN PART, WITHOUT WRITTEN PERMISSION OF MINI-CIRCUITS.

SIZE A	CODE IDENT 15542	DRAWING NO: 98-PL-244	REV: OR
-----------	---------------------	--------------------------	------------

FILE: 98PL244	SCALE: 8:1	SHEET: 1 OF 1
------------------	---------------	------------------

ASHEETA1.DWG REV:A DATE:01/12/95

Evaluation Board and Circuit

For Pin Connections refer to Data Sheet of the DUT

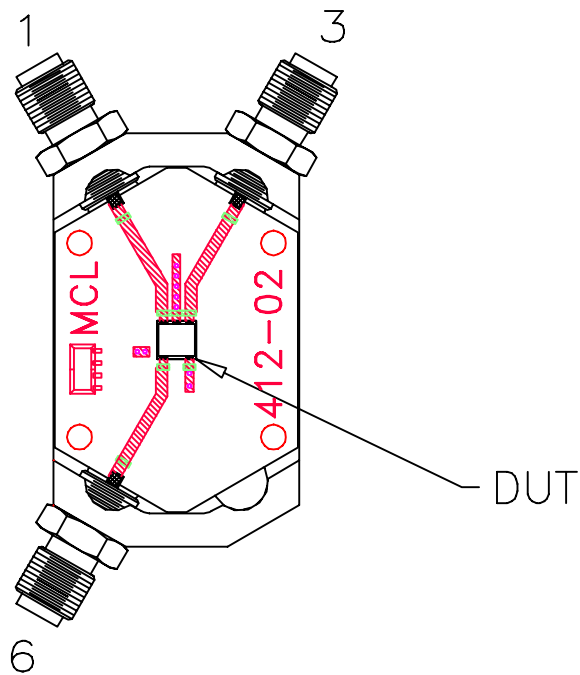

TB-145

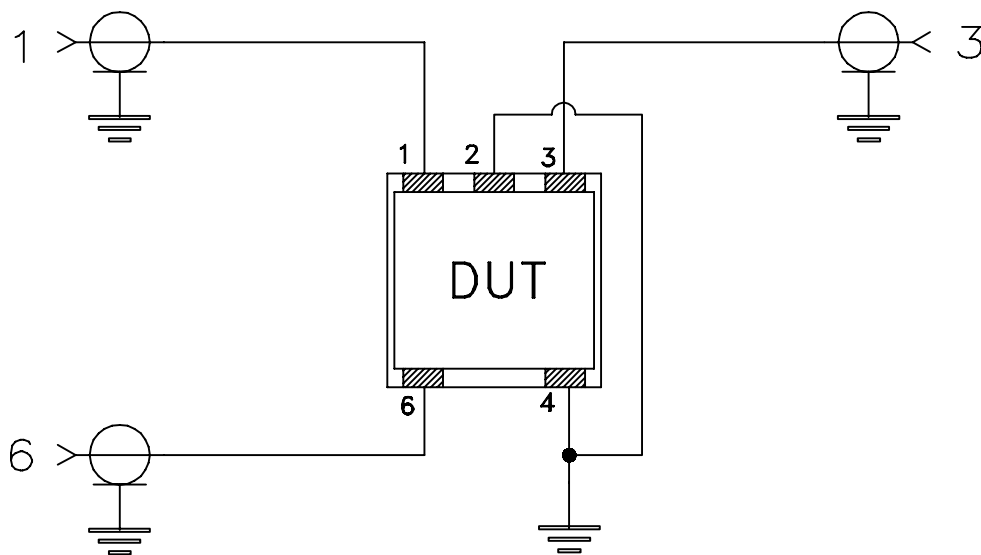

Schematic Diagram

Notes:

1. 50 Ohm SMA Female connectors.
2. PCB Material: Rogers RO4350B or its equivalent, Dielectric Constant=3.5, Thickness=.020"

 **Mini-Circuits®**



All Mini-Circuits products are manufactured under exacting quality assurance and control standards, and are capable of meeting published specifications after being subjected to any or all of the following physical and environmental test.

Specification	Test/Inspection Condition	Reference/Spec
Operating Temperature	-40° to 85°C Ambient Environment	Individual Model Data Sheet
Storage Temperature	-55° to 100° C Ambient Environment	Individual Model Data Sheet
Humidity	90 to 95% RH, 240 hours, 50°C	MIL-STD-202, Method 103, Condition A, Except 50°C and end-point electrical test done within 12 hours
Thermal Shock	-55° to 100°C, 100 cycles	MIL-STD-202, Method 107, Condition A-3, except +100°C
Solder Reflow Heat	Sn-Pb Eutetic Process: 225°C peak Pb-Free Process 245° - 250°C peak	J-STD-020, Table 4-1, 4-2 and 5-2, Figure 5-1
Solderability	10X Magnification	J-STD-002, 95% Coverage
Vibration (High Frequency)	20g peak, 10-2000 Hz, 12 times in each of three perpendicular directions (total 36)	MIL-STD-202, Method 204, Condition D
Mechanical Shock	50g, 11 ms, 1/2-sine, 18 shocks: 3 each direction, each of 3 axes	MIL-STD-202, Method 213, Condition A
Marking Resistance to Solvents	Isopropyl alcohol + mineral spirits at 25°C; terpene defluxer at 25°C; distilled water + proylene glycol monomethyl ether + monoethanolamine at 63°C to 70°C	MIL-STD-202, Method 215