

Evaluation Board and Circuit

SEE DETAIL "A"

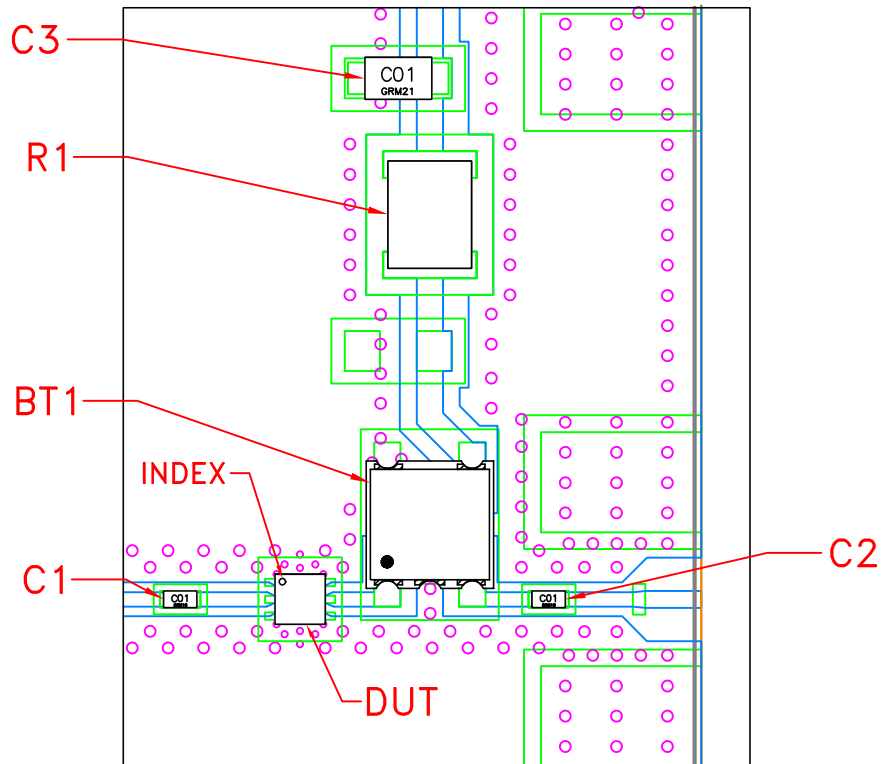

DETAIL "A"
LOCATION OF COMPONENTS
ON THE PCB
(SCALE 3:1)

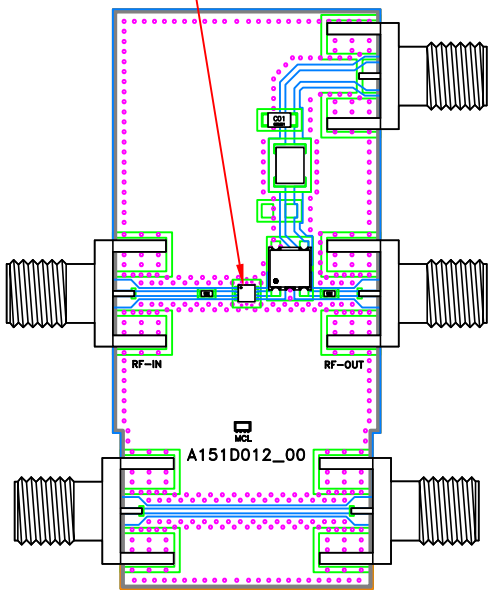
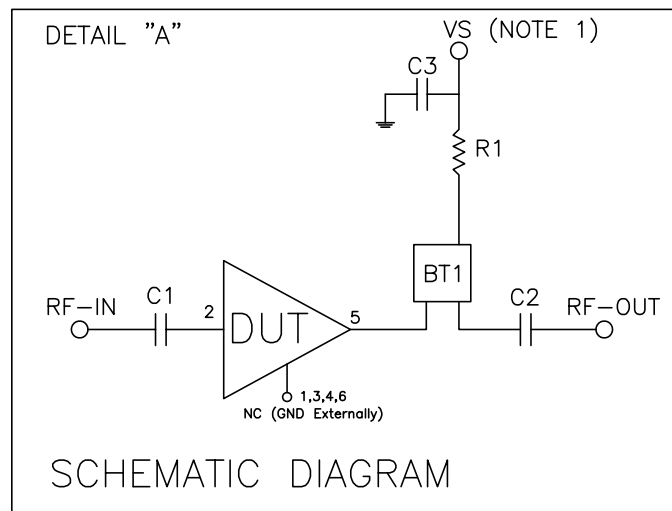

Components	Size	Value	Part Numbers	Manufacturer
C1,C2	0402	2.4nF	GRM1557U1A242JA1D	Murata
C3	0805	0.1uF	GCM21BR91H104KA37L	Murata
R1	1210	0Ω	RC1210JR-070RL	Yageo
BT1	N/A	N/A	TCBT-14+	Mini Circuits

NOTES:

1. VS Voltage=+5V
2. 50 Ohm SMA Female Connectors.
3. PCB Material: Roger R04350B or equivalent, Dielectric constant=3.5, Thickness=0.010 inch

