



Test Cable

T40-3FT-KMKM+

Mini-Circuits

50Ω 3FT DC to 40 GHz Low Loss 2.92mm-Male

THE BIG DEAL

- Low Insertion Loss
- Stainless steel 40 GHz connectors for long mating-cycle life
- Triple shield cable for excellent shielding effectiveness
- Good Amplitude and Phase stability vs. Flexing over frequency
- 40 GHz connector mates with 2.92mm, K*, 3.5mm, SMA



Generic photo used for illustration purposes only

Model No.	T40-3FT-KMKM+
Case Style	RK2525-3
Connectors	2.92mm-Male

+RoHS Compliant

The +Suffix identifies RoHS Compliance. See our website for methodologies and qualifications

Product Guarantee

Mini-Circuits® will repair or replace your test cable at its option if the connector attachment fails within six months of shipment. This guarantee excludes cable or connector interface damage from misuse or abuse.

APPLICATIONS

- Military and Defense Applications
- Research & development labs

PRODUCT OVERVIEW

Mini-Circuits' T40-series test cables provide wideband performance for test applications from DC to 40 GHz with low insertion loss and excellent return loss. These cables are specially designed for stability of phase and amplitude versus flexure while offering outstanding durability and reliability. Featuring triple-shielded cable construction with a unique molded boot, the cables are suitable for demanding lab environments where constant bending is required. T40-series cables come in a variety of lengths and various combinations of 2.92mm and 2.4mm connectors with different gender configurations to meet your needs.

KEY FEATURES

Feature	Advantages
Wideband, DC to 40 GHz	Supports a wide range of test applications including R&D, military and defense, production test and more.
Excellent stability of phase versus flexure	T40-series test cables have been tested in bend radii as tight as 2.0 inches to ensure minimal change in phase, providing reliable performance in a wide range of configurations.
Low Insertion Loss	Allows accurate measurement with minimal compensation for the effects of the cable connection.
2.92mm and 2.4mm connector options	Mates with common connector types for high-frequency test applications.





Test Cable

T40-3FT-KMKM+

Mini-Circuits

50Ω 3FT DC to 40 GHz Low Loss 2.92mm-Male

ELECTRICAL SPECIFICATIONS AT +25°C

Parameter	Frequency (GHz)	Min.	Typ.	Max.	Units
Frequency range		DC		40	GHz
Length		3			FT
Insertion Loss	DC - 6	—	1.0	1.3	dB
	6 - 18	—	2.0	2.3	
	18 - 26.5	—	2.4	2.8	
	26.5 - 40	—	3.3	3.6	
Return Loss	DC - 6	22	27	—	dB
	6 - 18	20	25	—	
	18 - 26.5	19	24	—	
	26.5 - 40	17	20	—	

*K Connector is a trademark of Anritsu.
Custom sizes available, consult factory

ABSOLUTE MAXIMUM RATINGS

Parameter	Ratings
Operating Temperature	+18°C to +28°C
Storage Temperature	-40°C to +50°C
Power Handling at 25°C, Sea Level	144 W at 2 GHz
	48 W at 18 GHz
	38 W at 26.5 GHz
	30 W at 40 GHz

Permanent damage may occur if any of these limits are exceeded.





Test Cable

T40-3FT-KMKM+

Mini-Circuits

50Ω 3FT DC to 40 GHz Low Loss 2.92mm-Male

CABLE CONSTRUCTION

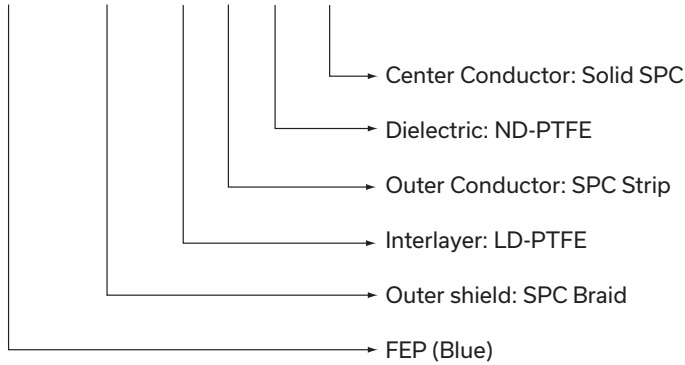

OUTLINE DRAWING

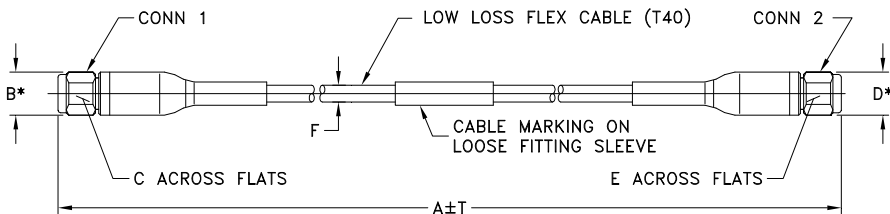

* OVERALL CONNECTOR OR CABLE & BOOT DIM
[CONNECTOR SHAPE MAY VARY]

OUTLINE DIMENSIONS (Inch/mm)

A		B	C	D	E	F	T	wt
Feet	Meters	0.36	.315	0.36	.315	.142	Inch	grams
3.00	0.91	9.25	8.00	9.25	8.00	3.61	+2.0/-0	60





Test Cable

T40-3FT-KMKM+

Mini-Circuits

50Ω 3FT DC to 40 GHz Low Loss 2.92mm-Male

TYPICAL PERFORMANCE DATA

Frequency (MHz)	Insertion Loss (dB)	Return Loss (dB)	
		2.92mm-Female	2.92mm-Male
100	0.14	46.1	40.1
2000	0.63	42.9	44.3
4000	0.88	48.9	49.4
6000	1.08	33.4	31.6
10000	1.39	27.2	27.6
15000	1.70	30.2	30.2
18000	1.88	36.0	34.5
20000	1.99	39.5	38.7
26000	2.33	30.0	34.7
28000	2.41	34.1	42.0
30000	2.50	31.4	35.9
32000	2.60	27.5	30.9
36000	2.78	25.9	30.2
38000	2.87	28.2	30.1
40000	2.96	30.7	29.5

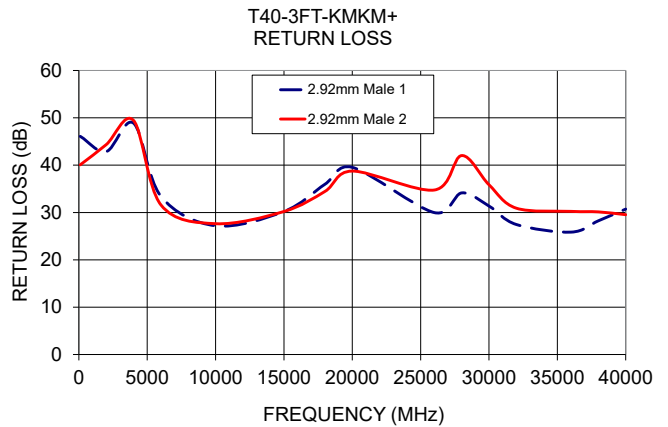
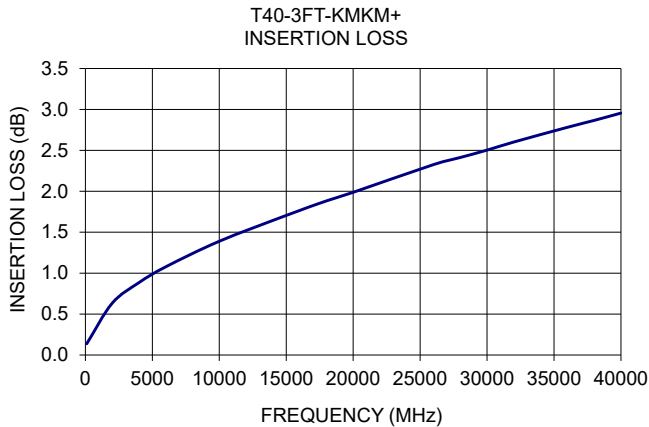
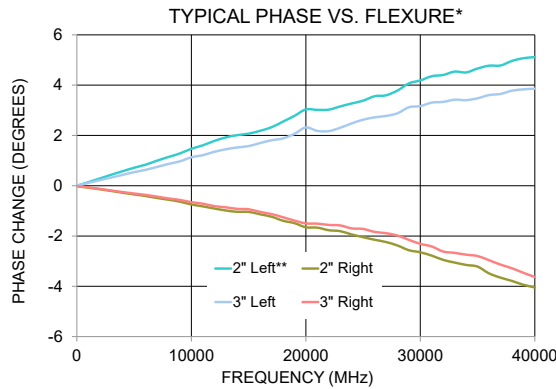

- NOTES**
- A. Performance and quality attributes and conditions not expressly stated in this specification document are intended to be excluded and do not form a part of this specification document.
 - B. Electrical specifications and performance data contained in this specification document are based on Mini-Circuit's applicable established test performance criteria and measurement instructions.
 - C. The parts covered by this specification document are subject to Mini-Circuits standard limited warranty and terms and conditions (collectively, "Standard Terms"); Purchasers of this part are entitled to the rights and benefits contained therein. For a full statement of the standard. Terms and the exclusive rights and remedies thereunder, please visit Mini-Circuits' website at www.minicircuits.com/MCLStore/terms.jsp



Typical Performance Data

FREQUENCY (MHz)	INSERTION LOSS (dB)	2.92mm-MALE 1 RETURN LOSS (dB)	2.92mm-MALE 2 RETURN LOSS (dB)
100	0.14	46.1	40.1
400	0.28	36.4	38.1
700	0.37	39.9	39.3
1000	0.45	35.3	37.9
1500	0.55	31.1	34.9
2000	0.63	42.9	44.3
2500	0.70	44.3	46.7
3000	0.77	34.3	35.3
3500	0.83	38.2	37.2
4000	0.88	48.9	49.4
4500	0.94	39.8	43.1
5000	0.99	36.2	32.1
5500	1.03	32.4	32.7
6000	1.08	33.4	31.6
6500	1.12	29.2	31.9
7000	1.16	32.5	33.5
7500	1.20	30.2	30.4
8000	1.24	28.8	29.1
9000	1.31	29.7	29.9
10000	1.39	27.2	27.6
11000	1.46	27.2	26.5
12000	1.52	34.1	35.9
13000	1.58	32.2	33.5
14000	1.64	31.5	33.2
15000	1.70	30.2	30.2
16000	1.76	35.5	36.4
17000	1.82	38.8	36.8
18000	1.88	36.0	34.5
20000	1.99	39.5	38.7
22000	2.07	41.4	39.6
24000	2.22	29.8	29.7
26000	2.33	30.0	34.7
28000	2.41	34.1	42.0
30000	2.50	31.4	35.9
32000	2.60	27.5	30.9
34000	2.69	27.8	33.1
36000	2.78	25.9	30.2
38000	2.87	28.2	30.1
40000	2.96	30.7	29.5

Typical Performance Curves

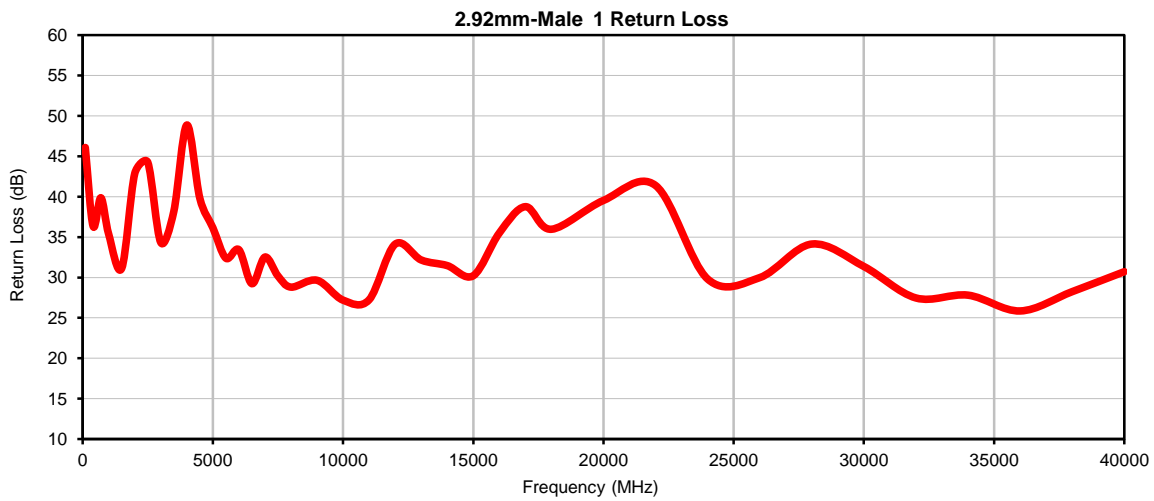
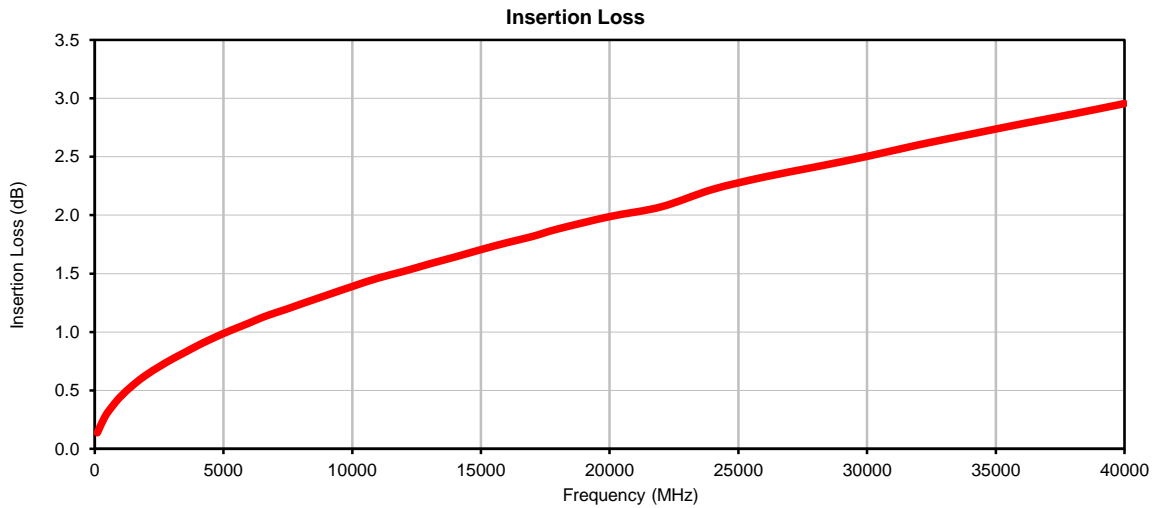

Outline Dimensions

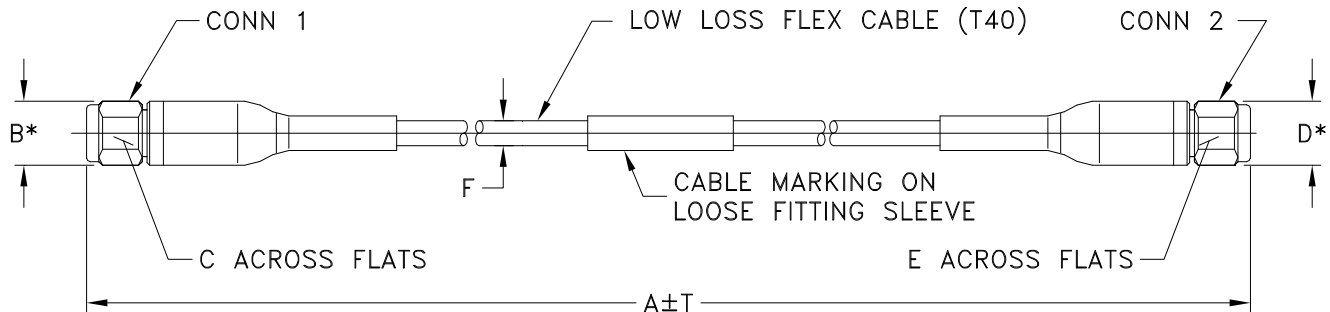

* OVERALL CONNECTOR OR CABLE & BOOT DIM
[CONNECTOR SHAPE MAY VARY]

RK2525 SERIES

2.92mm MALE (CONN-1)

2.92mm MALE (CONN-2)

CASE STYLE #	A		B	C	D	E	F	T		WEIGHT GRAMS
	FEET	METERS						INCH	MM	
RK2525-2	2.00	.61	.36 (9.25)	.315 (8.00)	.36 (9.25)	.315 (8.00)	.142 (3.60)	+.08/-0	+2.0/-0	49
RK2525-3	3.00	.91						+.08/-0	+2.0/-0	60

Unless otherwise specified dimensions are in inches (mm).

Tolerances: 2Pl. $\pm .03$; 3Pl. $\pm .015$

Note:

1. Low Loss Flexible (T40) Cable.



All Mini-Circuits products are manufactured under exacting quality assurance and control standards, and are capable of meeting published specifications after being subjected to any or all of the following physical and environmental test.

Specification	Test/Inspection Condition	Reference/Spec
Operating Temperature	+18°C to 28°C Ambient Environment	Individual Model Data Sheet
Storage Temperature	-40° to 50°C Ambient Environment	Individual Model Data Sheet