

Power Splitter/Combiner

SYPS-2-282-75+

2 Way-0° 75Ω 5 to 2750 MHz

Maximum Ratings

Operating Temperature	-40°C to 85°C
Storage Temperature	-55°C to 100°C
Power Input (as a splitter)	0.5W max.
Internal Dissipation	0.05W max.
Permanent damage may occur if any of these limits are exceeded.	

Pin Connections

SUM PORT	8
PORT 1	4
PORT 2	5
GROUND	1,2,3,6,7

Outline Drawing

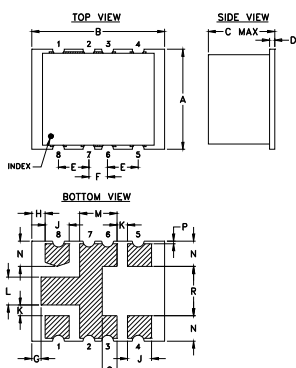

PCB Land Pattern

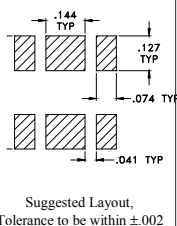

Outline Dimensions (inch/mm)

A	.38	B	.50	C	.25	D	.020	E	.115	F	.070	G	.035	H	.050	J	.090	K	.040	wt	
	9.65	12.70	6.35	0.51	2.92	1.78	0.89	1.27	2.29	1.02											grams
L	.105	M	.140	N	.095	O	.010	P	.055	Q	.185	R	--	S	--	T	--				0.52
	2.67	3.56	2.41	0.25	1.40	4.70	--	--	--	--	--	--	--	--	--	--	--				

Demo Board MCL P/N: TB-426+ Suggested PCB Layout (PL-268)

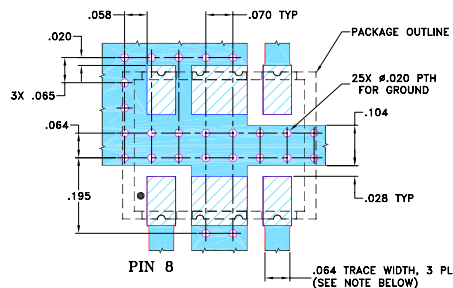

NOTES: 1. TRACE WIDTH IS SHOWN FOR ROGERS RO4350B WITH DIELECTRIC THICKNESS .060 ± .004; COPPER: 1/2 OZ. EACH SIDE. FOR OTHER MATERIALS TRACE WIDTH MAY NEED TO BE MODIFIED.
2. BOTTOM SIDE OF THE PCB IS CONTINUOUS GROUND PLANE.

- DENOTES PCB COPPER LAYOUT WITH SMOBC (SOLDER MASK OVER BARE COPPER)
- DENOTES COPPER LAND PATTERN FREE OF SOLDER MASK

Notes

A. Performance and quality attributes and conditions not expressly stated in this specification document are intended to be excluded and do not form a part of this specification document.
B. Electrical specifications and performance data contained in this specification document are based on Mini-Circuits' applicable established test performance criteria and measurement instructions.
C. The parts covered by this specification document are subject to Mini-Circuits' standard limited warranty and terms and conditions (collectively, "Standard Terms"); Purchasers of this part are entitled to the rights and benefits contained therein. For a full statement of the Standard Terms and the exclusive rights and remedies thereunder, please visit Mini-Circuits' website at www.minicircuits.com/MCLStore/terms.jsp

Features

- wideband, 5 to 2750 MHz. useable 0.5 to 3000 MHz
- low insertion loss, 0.8 dB typ.
- high isolation, 25 dB typ.

Applications

- VHF/UHF
- communications systems
- receivers & transmitters
- instrumentation
- CATV



Generic photo used for illustration purposes only

CASE STYLE: AH202

+RoHS Compliant

The +Suffix identifies RoHS Compliance. See our web site for RoHS Compliance methodologies and qualifications

Available Tape and Reel at no extra cost

Reel Size	Devices/Reel
13"	200

Electrical Specifications

FREQ. RANGE (MHz)	ISOLATION (dB)			INSERTION LOSS (dB) ABOVE 3.0 dB			PHASE UNBALANCE (Degrees)			AMPLITUDE UNBALANCE (dB)								
	L	M	U	L	M	U	L	M	U	L	M	U						
	Typ. Min.	Typ. Min.	Typ. Min.	Typ. Max.	Typ. Max.	Typ. Max.	Max. Max.	Max. Max.	Max. Max.	Max. Max.	Max. Max.	Max. Max.						
f_L - f_U	20	12	25	18	22	13	0.5	0.7	0.8	1.1	1.5	2.7	2.0	4.0	6.0	0.2	0.4	1.0
5-2750																		

L = low range [f_L to $10 f_L$] M = mid range [$10 f_L$ to $f_U/2$] U = upper range [$f_U/2$ to f_U]

Typical Performance Data

Frequency (MHz)	Total Loss ¹ (dB)		Amplitude Unbalance (dB)	Isolation (dB)	Phase Unbalance (deg.)	VSWR S	VSWR 1	VSWR 2
	S-1	S-2						
5.00	3.43	3.40	0.03	17.50	0.12	1.05	1.61	1.62
50.00	3.44	3.40	0.04	21.82	0.01	1.04	1.43	1.44
100.00	3.46	3.43	0.03	21.76	0.06	1.05	1.43	1.43
200.00	3.47	3.44	0.03	22.03	0.23	1.08	1.41	1.41
400.00	3.50	3.49	0.02	22.92	0.48	1.15	1.37	1.39
600.00	3.55	3.54	0.02	24.27	0.70	1.22	1.34	1.37
800.00	3.60	3.65	0.05	26.42	0.83	1.27	1.32	1.35
1000.00	3.62	3.69	0.07	30.66	0.96	1.28	1.29	1.31
1200.00	3.66	3.74	0.08	33.93	1.24	1.24	1.22	1.24
1400.00	3.70	3.77	0.06	28.30	0.92	1.17	1.13	1.16
1800.00	3.85	3.93	0.08	22.96	0.63	1.12	1.05	1.06
2000.00	3.99	4.05	0.06	22.39	0.42	1.19	1.09	1.12
2400.00	4.23	4.20	0.04	23.46	0.16	1.29	1.18	1.19
2600.00	4.47	4.31	0.16	22.96	0.39	1.29	1.26	1.20
2750.00	4.56	4.35	0.21	24.26	0.54	1.26	1.26	1.19

1. Total Loss = Insertion Loss + 3dB splitter loss.

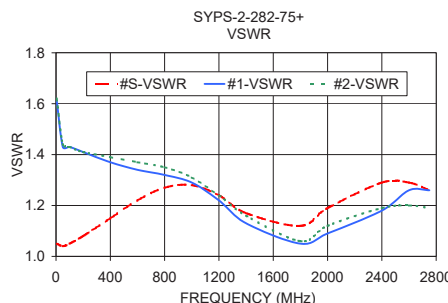
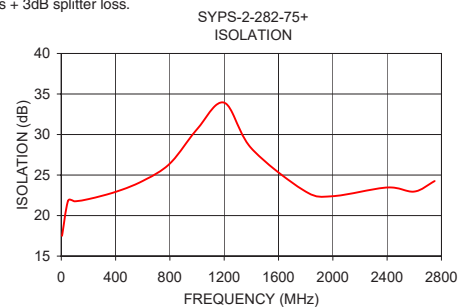
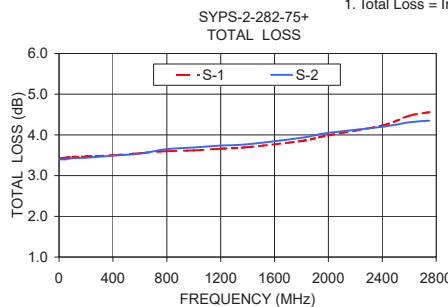

electrical schematic



2 Way-0° Power Splitter/Combiner

SYPS-2-282-75+

Typical Performance Data

FREQUENCY (MHz)	TOTAL LOSS ¹ (dB)		AMPLITUDE UNBALANCE (dB)	ISOLATION (dB)	PHASE UNBALANCE (deg.)	FREQUENCY (MHz)	VSWR (:1)		
	S-1	S-2					S	1	2
	3.0	3.47					3.43	0.03	15.34
4.0	3.44	3.41	0.03	16.53	0.12	4.0	1.06	1.67	1.68
5.0	3.43	3.40	0.03	17.50	0.12	5.0	1.05	1.61	1.62
6.0	3.42	3.39	0.03	18.29	0.12	6.0	1.04	1.56	1.57
7.0	3.42	3.38	0.03	18.93	0.11	7.0	1.04	1.53	1.54
8.0	3.41	3.38	0.03	19.46	0.12	8.0	1.04	1.51	1.52
9.0	3.41	3.38	0.03	19.89	0.10	9.0	1.04	1.49	1.50
10.0	3.41	3.38	0.03	20.25	0.10	10.0	1.04	1.48	1.49
20.0	3.42	3.38	0.03	21.68	0.09	20.0	1.03	1.44	1.45
30.0	3.43	3.39	0.04	21.87	0.05	30.0	1.03	1.43	1.44
40.0	3.43	3.40	0.04	21.87	0.05	40.0	1.03	1.43	1.44
50.0	3.44	3.40	0.04	21.82	0.01	50.0	1.04	1.43	1.44
60.0	3.45	3.41	0.04	21.80	0.02	60.0	1.04	1.43	1.44
70.0	3.45	3.41	0.04	21.80	0.01	70.0	1.04	1.43	1.44
80.0	3.45	3.42	0.04	21.79	0.01	80.0	1.04	1.43	1.43
90.0	3.45	3.42	0.03	21.78	0.03	90.0	1.05	1.43	1.43
100.0	3.46	3.43	0.03	21.76	0.06	100.0	1.05	1.43	1.43
150.0	3.47	3.44	0.04	21.79	0.10	150.0	1.07	1.42	1.43
200.0	3.47	3.44	0.03	22.03	0.23	200.0	1.08	1.41	1.41
250.0	3.49	3.46	0.03	22.17	0.26	250.0	1.11	1.39	1.41
300.0	3.49	3.45	0.03	22.45	0.33	300.0	1.12	1.39	1.40
350.0	3.50	3.48	0.03	22.52	0.44	350.0	1.14	1.37	1.39
400.0	3.50	3.49	0.02	22.92	0.48	400.0	1.15	1.37	1.39
450.0	3.52	3.49	0.03	22.96	0.47	450.0	1.18	1.35	1.38
500.0	3.53	3.52	0.01	23.47	0.74	500.0	1.19	1.35	1.38
550.0	3.54	3.54	0.00	23.60	0.55	550.0	1.21	1.34	1.37
600.0	3.55	3.54	0.02	24.27	0.70	600.0	1.22	1.34	1.37
650.0	3.56	3.57	0.02	24.44	0.78	650.0	1.24	1.33	1.36
700.0	3.58	3.59	0.01	25.27	0.67	700.0	1.25	1.33	1.36
750.0	3.59	3.59	0.01	25.76	0.89	750.0	1.26	1.33	1.35
800.0	3.60	3.65	0.05	26.42	0.83	800.0	1.27	1.32	1.35
850.0	3.60	3.62	0.02	27.56	0.82	850.0	1.27	1.32	1.33
900.0	3.62	3.67	0.06	28.12	0.96	900.0	1.28	1.31	1.33
950.0	3.62	3.67	0.05	29.55	0.92	950.0	1.28	1.30	1.31
1000.0	3.62	3.69	0.07	30.66	0.96	1000.0	1.28	1.29	1.31
1100.0	3.63	3.72	0.09	33.27	1.09	1100.0	1.27	1.26	1.28
1200.0	3.66	3.74	0.08	33.93	1.24	1200.0	1.24	1.22	1.24
1300.0	3.68	3.74	0.06	31.56	1.08	1300.0	1.21	1.18	1.20
1375.0	3.68	3.76	0.07	29.37	1.05	1375.0	1.19	1.14	1.17
1400.0	3.70	3.77	0.06	28.30	0.92	1400.0	1.17	1.13	1.16
1500.0	3.71	3.80	0.08	26.27	0.81	1500.0	1.14	1.08	1.12
1600.0	3.74	3.83	0.09	25.14	0.78	1600.0	1.11	1.03	1.08
1700.0	3.78	3.87	0.09	24.12	0.73	1700.0	1.10	1.02	1.06
1800.0	3.85	3.93	0.08	22.96	0.63	1800.0	1.12	1.05	1.06
1900.0	3.92	3.99	0.07	22.55	0.52	1900.0	1.15	1.08	1.09
2000.0	3.99	4.05	0.06	22.39	0.42	2000.0	1.19	1.09	1.12
2100.0	4.07	4.10	0.03	22.12	0.33	2100.0	1.23	1.10	1.15
2200.0	4.13	4.15	0.02	22.05	0.20	2200.0	1.26	1.11	1.17
2300.0	4.18	4.18	0.00	22.81	0.11	2300.0	1.28	1.14	1.18
2400.0	4.23	4.20	0.04	23.46	0.16	2400.0	1.29	1.18	1.19
2500.0	4.33	4.25	0.08	23.15	0.23	2500.0	1.30	1.22	1.20
2600.0	4.47	4.31	0.16	22.96	0.39	2600.0	1.29	1.26	1.20
2700.0	4.57	4.35	0.22	23.50	0.21	2700.0	1.28	1.25	1.19
2750.0	4.56	4.35	0.21	24.26	0.54	2750.0	1.26	1.26	1.19
2800.0	4.61	4.34	0.27	23.29	0.24	2800.0	1.26	1.26	1.19
2900.0	4.74	4.45	0.29	23.57	0.29	2900.0	1.26	1.26	1.21
3000.0	4.92	4.57	0.35	24.32	0.37	3000.0	1.26	1.28	1.22
3020.0	4.97	4.59	0.38	25.60	0.65	3020.0	1.27	1.30	1.23
3040.0	5.03	4.59	0.44	25.36	0.54	3040.0	1.29	1.28	1.23
3060.0	5.08	4.63	0.45	24.35	0.24	3060.0	1.29	1.27	1.23
3080.0	5.12	4.69	0.43	24.43	0.34	3080.0	1.29	1.29	1.24
3100.0	5.17	4.72	0.45	25.22	0.76	3100.0	1.29	1.32	1.25
3120.0	5.24	4.72	0.51	24.92	0.86	3120.0	1.31	1.33	1.27
3140.0	5.30	4.76	0.54	24.05	0.71	3140.0	1.33	1.33	1.26
3160.0	5.35	4.83	0.52	23.90	0.72	3160.0	1.34	1.33	1.26
3180.0	5.41	4.89	0.52	24.27	1.06	3180.0	1.34	1.35	1.29
3200.0	5.50	4.92	0.58	23.99	1.23	3200.0	1.33	1.38	1.30

¹Total Loss = Insertion Loss + 3dB Solitler Loss



P.O. Box 350166, Brooklyn, New York 11235-0003 (718) 934-4500 • Fax (718) 332-4661 For detailed performance specs & shopping online see Mini-Circuits web site
 The Design Engineers Search Engine Provides ACTUAL Data Instantly From MINI-CIRCUITS At: www.minicircuits.com

REV. X2
 SYPS-2-282-75+
 8/5/2010

IF/RF MICROWAVE COMPONENTS

2 Way-0° Power Splitter/Combiner

SYPS-2-282-75+

Typical Performance Curves

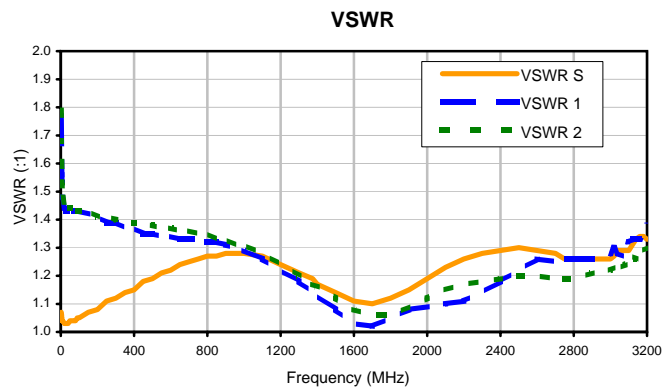
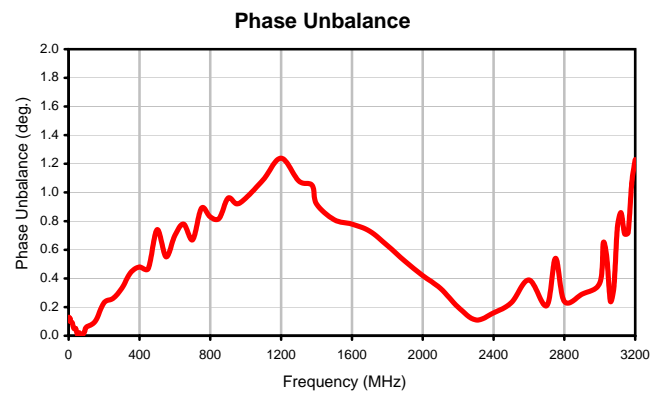
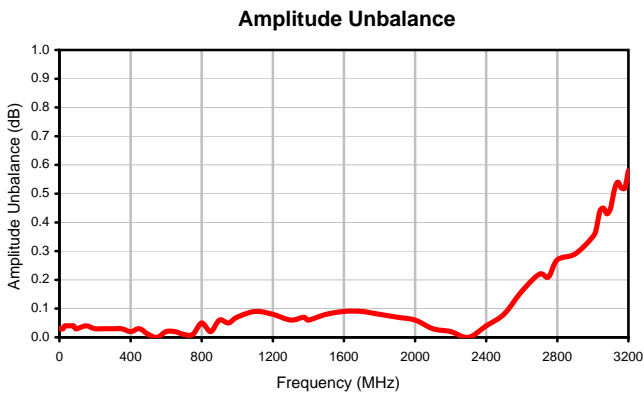
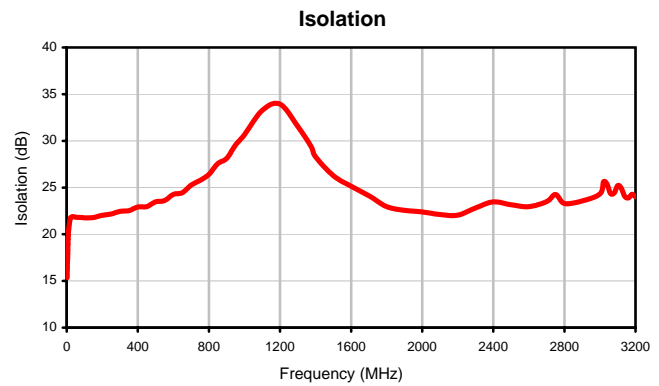
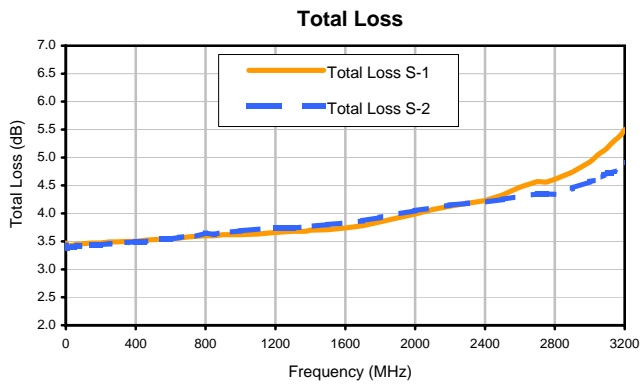

Outline Dimensions

AH202-2

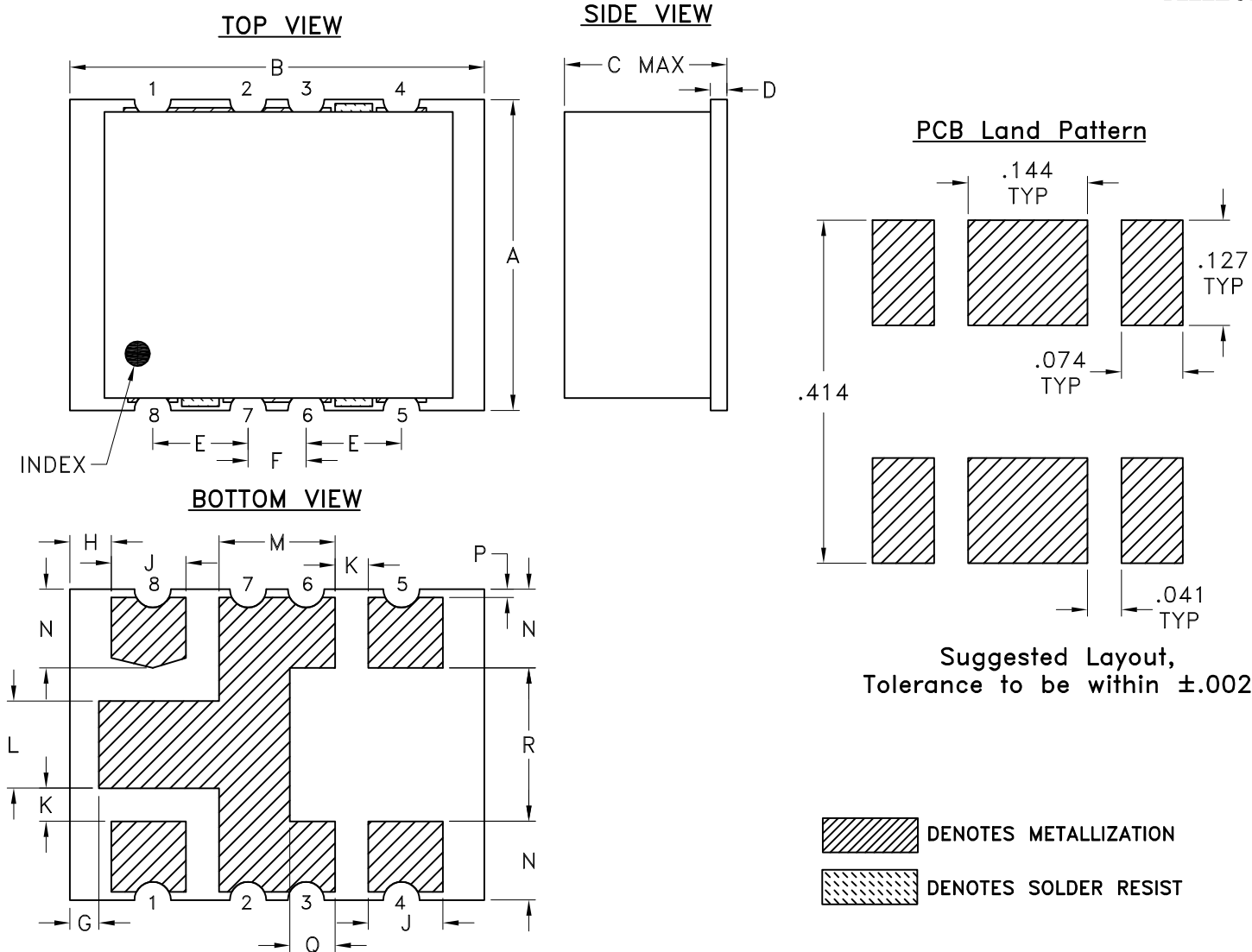

CASE#	A	B	C	D	E	F	G	H	J	K	L	M	N	P
AH202-2	.38 (9.65)	.50 (12.70)	.25 (6.35)	.020 (0.51)	.115 (2.92)	.070 (1.78)	.035 (0.89)	.050 (1.27)	.090 (2.29)	.040 (1.02)	.105 (2.67)	.140 (3.56)	.095 (2.41)	.010 (0.25)

CASE#	Q	R	WT, GRAM
AH202-2	.055 (1.40)	.185 (4.70)	.52

Dimensions are in inches (mm). Tolerances: 2 Pl. $\pm .01$; 3 Pl. $\pm .005$

Notes:

- Case material: Plastic.
- Base material: Printed wiring laminate.
- Termination finish:
 - For RoHS 3-5 μ inch (.08-.13 microns) Gold over 120-240 μ inch (3.05-6.10 microns) Nickel plate. All models, (+) suffix.
 - For RoHS-5 Case Styles: Tin-Lead plate. All models, no (+) suffix.

Mini-Circuits
ISO 9001 ISO 14001 CERTIFIED

ALL NEW
minicircuits.com

P.O. Box 350166, Brooklyn, New York 11235-0003 (718) 934-4500 Fax (718) 332-4661 For detailed performance specs & shopping online see Mini-Circuits web site



The Design Engineers Search Engine Provides ACTUAL Data Instantly From MINI-CIRCUITS At: www.minicircuits.com

RF/IF MICROWAVE COMPONENTS

Tape & Reel Packaging TR-F61

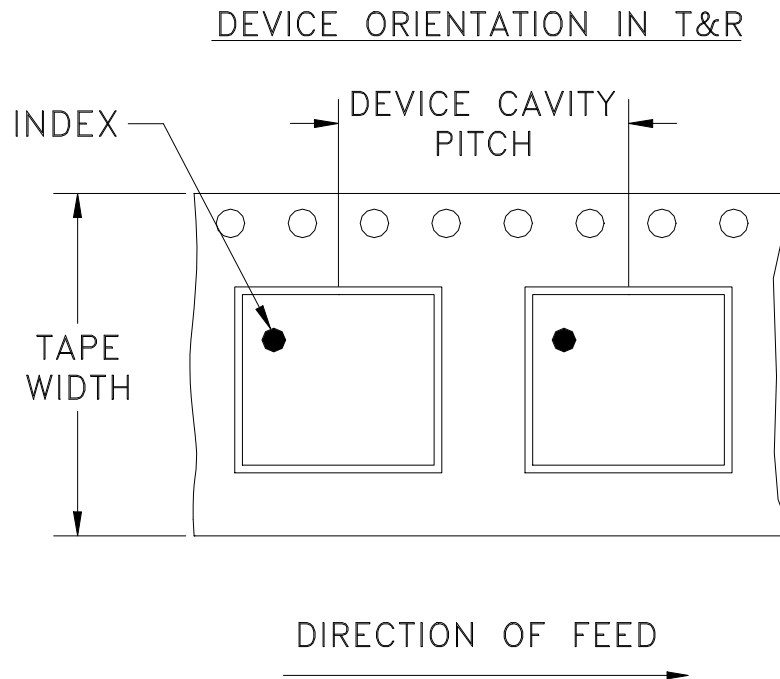

Tape Width, mm	Device Cavity Pitch, mm	Reel Size, inches	Devices per Reel
24	12	13	200

Mini-Circuits carrier tape materials provide protection from ESD (Electro-Static Discharge) during handling and transportation. Tapes are static dissipative and comply with industry standards EIA-481/EIA-541.

Go to: www.minicircuits.com/pages/pdfs/tape.pdf

 **Mini-Circuits**[®]

INTERNET <http://www.minicircuits.com>

P.O. Box 350166, Brooklyn, New York 11235-0003 (718) 934-4500 Fax (718) 332-4661

Distribution Centers NORTH AMERICA 800-654-7949 • 417-335-5935 • Fax 417-335-5945 • EUROPE 44-1252-832600 • Fax 44-1252-837010

Mini-Circuits ISO 9001 & ISO 14001 Certified

THIRD ANGLE PROJECTION

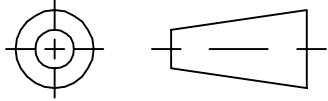

REVISIONS

REV OR	ECN No.	DESCRIPTION	DATE	DR	AUTH
	M109780	NEW RELEASE	04/17/07	PW	HY

**SUGGESTED MOUNTING CONFIGURATION FOR
AH202-2 CASE STYLE, "sb" PIN CONNECTION**

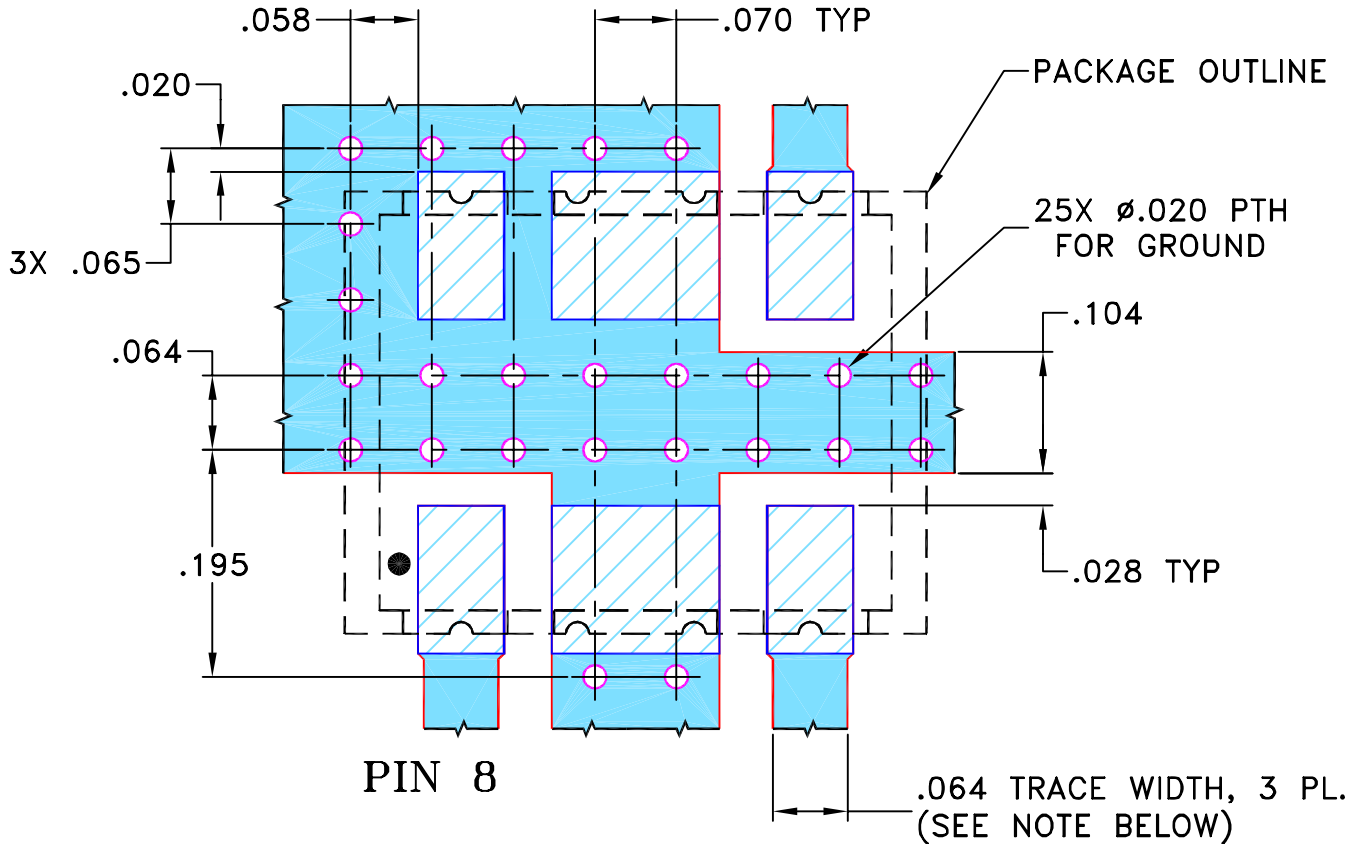

- NOTES: 1. TRACE WIDTH IS SHOWN FOR ROGERS R04350B WITH DIELECTRIC THICKNESS .060" ± .004"; COPPER: 1/2 OZ. EACH SIDE. FOR OTHER MATERIALS TRACE WIDTH MAY NEED TO BE MODIFIED.
 2. BOTTOM SIDE OF THE PCB IS CONTINUOUS GROUND PLANE.



DENOTES PCB COPPER LAYOUT WITH SMOBC (SOLDER MASK OVER BARE COPPER)



DENOTES COPPER LAND PATTERN FREE OF SOLDER MASK

UNLESS OTHERWISE SPECIFIED

INITIALS DATE

DIMENSIONS ARE IN INCHES
 TOLERANCES ON:
 2 PL DECIMALS ±
 3 PL DECIMALS ± .005
 ANGLES ±
 FRACTIONS ±

DRAWN	PW	02/09/07
CHECKED	IL	02/16/07
APPROVED	HY	04/17/07



Mini-Circuits®

13 Neptune Avenue
 Brooklyn NY 11235

PL, sb, 75, AH202-2, SYPS-2, TB-426+

THIS DOCUMENT AND ITS CONTENTS ARE THE PROPERTY OF MINI-CIRCUITS. EXCEPT FOR USE EXPRESSLY GRANTED, IN WRITING, TO ITS VENDORS, VENDEE AND THE UNITED STATES GOVERNMENT, MINI-CIRCUITS RESERVES ALL PROPRIETARY DESIGN, USE, MANUFACTURING AND REPRODUCTION RIGHTS THERETO. THESE CONTENTS SHALL NOT BE USED, DUPLICATED OR DISCLOSED TO ANY OUTSIDE PARTY, IN WHOLE OR IN PART, WITHOUT WRITTEN PERMISSION OF MINI-CIRCUITS.

SIZE A	CODE IDENT 15542	DRAWING NO: 98-PL-268	REV: OR
FILE: 98PL268	SCALE: 6:1	SHEET: 1 OF 1	

Evaluation Board and Circuit

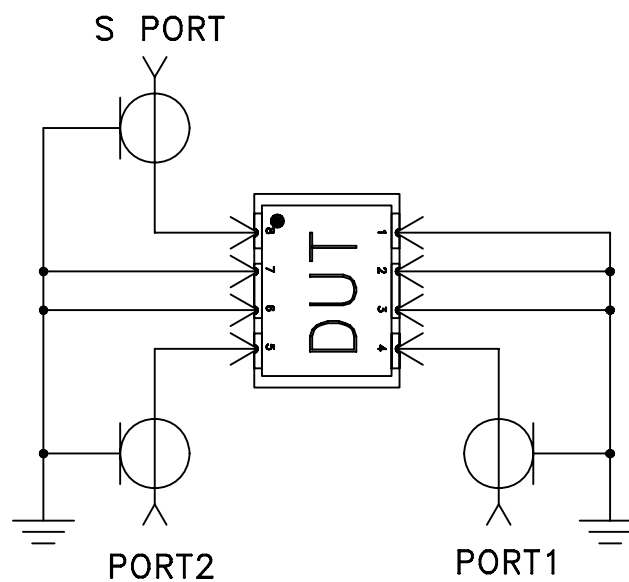
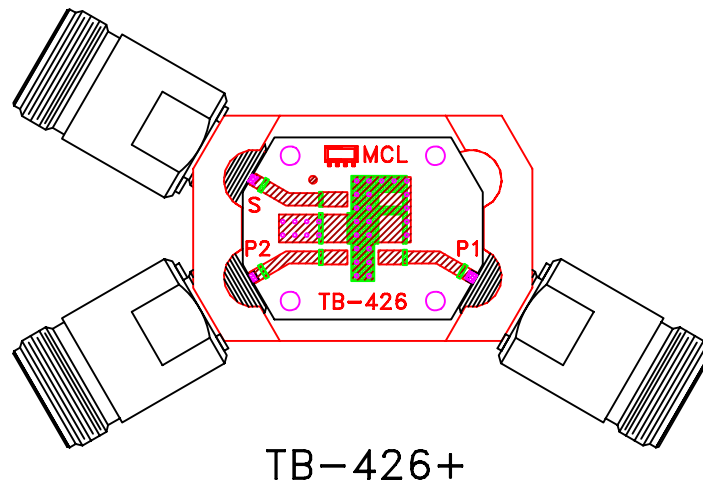

Schematic Diagram

Notes:

1. 75 Ohm N-type Female connectors.
2. PCB Material: Rogers R04350 or its equivalent, Dielectric Constant=3.5, Thickness=.060"

 Mini-Circuits®

All Mini-Circuits products are manufactured under exacting quality assurance and control standards, and are capable of meeting published specifications after being subjected to any or all of the following physical and environmental test.

Specification	Test/Inspection Condition	Reference/Spec
Operating Temperature	-40° to 85°C Ambient Environment	Individual Model Data Sheet
Storage Temperature	-55° to 100° C Ambient Environment	Individual Model Data Sheet
Humidity	90 to 95% RH, 240 hours, 50°C	MIL-STD-202, Method 103, Condition A, Except 50°C and end-point electrical test done within 12 hours
Thermal Shock	-55° to 100°C, 100 cycles	MIL-STD-202, Method 107, Condition A-3, except +100°C
Solder Reflow Heat	Sn-Pb Eutetic Process: 225°C peak Pb-Free Process 245° - 250°C peak	J-STD-020, Table 4-1, 4-2 and 5-2, Figure 5-1
Solderability	10X Magnification	J-STD-002, 95% Coverage
Vibration (High Frequency)	20g peak, 10-2000 Hz, 12 times in each of three perpendicular directions (total 36)	MIL-STD-202, Method 204, Condition D
Mechanical Shock	50g, 11 ms, 1/2-sine, 18 shocks: 3 each direction, each of 3 axes	MIL-STD-202, Method 213, Condition A
Marking Resistance to Solvents	Isopropyl alcohol + mineral spirits at 25°C; terpene defluxer at 25°C; distilled water + proylene glycol monomethyl ether + monoethanolamine at 63°C to 70°C	MIL-STD-202, Method 215