

Surface Mount Frequency Mixer

SYM-63LH+

Level 10 (LO Power +10 dBm) 1 to 6000 MHz

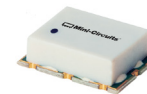

Generic photo used for illustration purposes only

CASE STYLE: TTT166

+RoHS Compliant
The +Suffix identifies RoHS Compliance. See our web site for RoHS Compliance methodologies and qualifications

Available Tape and Reel at no extra cost	
Reel Size	Devices/Reel
7"	10, 20, 50, 100, 200
13"	500

Maximum Ratings

Operating Temperature	-40°C to 85°C
Storage Temperature	-55°C to 100°C
RF Power	50mW
IF Current	40mA

Permanent damage may occur if any of these limits are exceeded.

Pin Connections

LO	2
RF	1
IF	3
GROUND	4,5,6

Features

- ultra wide bandwidth, 1-6000 MHz
- IF response to DC

Applications

- test equipment
- cable TV
- cellular
- PCS
- satellite distribution
- ISM/GPS
- WCDMA
- defence communications

Electrical Specifications @ 25°C

FREQUENCY (MHz)	CONVERSION LOSS* (dB)	LO-RF ISOLATION (dB)			LO-IF ISOLATION (dB)			IP3 at center band (dBm)						
		L	M	U	L	M	U							
1-6000	DC-1000	65	45	35	20	29	20	60	40	25	14	19	12	14

1 dB COMP: +3 dBm typ.

* Conversion Loss at 30 MHz IF.

σ is a measure of repeatability from unit to unit.

L = low range [f_c to $10 f_c$]

U = upper range [$f_c/2$ to f_c]

M = mid range [$10 f_c$ to $f_c/2$]

m = mid band [$2f_c$ to $f_c/2$]

Outline Drawing

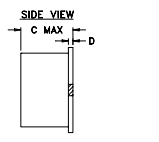
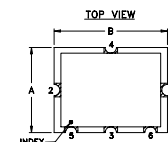

PCB Land Pattern

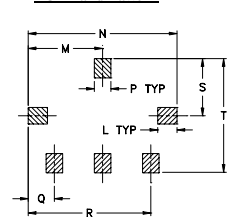
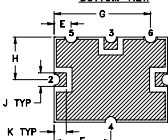

Suggested Layout,
Tolerance to be within ±.002

Outline Dimensions (inch/mm)

A	B	C	D	E	F	G	H	J	
.38	.50	.15	.020	.075	.250	.425	.187	.050	
9.65	12.70	3.81	0.51	1.91	6.35	10.80	4.75	1.27	
K	L	M	N	P	Q	R	S	T	wt.
.050	.070	.270	.540	.060	.095	.445	.208	.415	grams
1.27	1.78	6.86	13.72	1.52	2.41	11.30	5.28	10.54	0.8

Demo Board MCL P/N: TB-12 Suggested PCB Layout (PL-079)

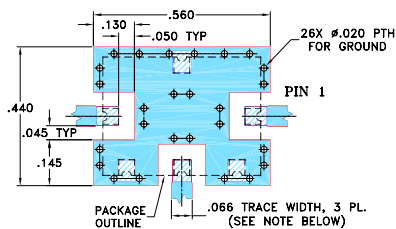

NOTE:

1. TRACE WIDTH IS SHOWN FOR ROGERS R04350B WITH DIELECTRIC THICKNESS .030" ± .002"; COPPER: 1/2 OZ. EACH SIDE. FOR OTHER MATERIALS TRACE WIDTH MAY NEED TO BE MODIFIED.
 2. THE USE OF SOLDER MASK OVER THE GROUND AREA UNDER THE UNIT AS SHOWN IS RECOMMENDED TO PREVENT POTENTIAL SHORTING. IF USER CHOOSES TO EXPOSE METAL UNDER THE ENTIRE UNIT GROUND PAD FOR IMPROVED GROUNDING, IT IS RECOMMENDED A SOLDER MASK DAM BE APPLIED AROUND EACH GROUND PAD TO ENSURE FILLET AND CONNECTION AT GROUND PADS.
 3. BOTTOM SIDE OF THE PCB IS CONTINUOUS GROUND PLANE.
- DENOTES PCB COPPER LAYOUT WITH SMOBC (SOLDER MASK OVER BARE COPPER), SEE NOTE 2.
 DENOTES COPPER LAND PATTERN FREE OF SOLDER MASK

Notes

- A. Performance and quality attributes and conditions not expressly stated in this specification document are intended to be excluded and do not form a part of this specification document.
- B. Electrical specifications and performance data contained in this specification document are based on Mini-Circuit's applicable established test performance criteria and measurement instructions.
- C. The parts covered by this specification document are subject to Mini-Circuits standard limited warranty and terms and conditions (collectively, "Standard Terms"); Purchasers of this part are entitled to the rights and benefits contained therein. For a full statement of the Standard Terms and the exclusive rights and remedies thereunder, please visit Mini-Circuits' website at www.minicircuits.com/MCLStore/terms.jsp



www.minicircuits.com P.O. Box 350166, Brooklyn, NY 11235-0003 (718) 934-4500 sales@minicircuits.com

Typical Performance Data

Frequency (MHz)	Conversion Loss (dB)		Isolation (dB)		VSWR	
	LO +10dBm	RF +10dBm	L-R (dB)	L-I (dB)	RF Port (:1)	LO Port (:1)
1.00	31.00	5.83	65.41	60.62	1.68	3.60
10.00	40.00	6.07	63.21	58.28	1.09	3.54
100.00	130.00	6.21	53.47	46.17	1.04	3.45
145.00	175.00	6.21	51.34	43.08	1.04	3.46
505.00	535.00	6.28	42.90	33.70	1.37	2.72
1000.00	1030.00	6.65	41.76	34.89	2.07	1.72
1500.00	1530.00	7.31	32.97	23.84	2.07	1.27
2000.00	2030.00	6.87	30.92	24.37	2.01	1.70
3000.00	3030.00	8.60	26.67	34.89	2.42	2.64
4000.00	4030.00	7.94	28.22	18.49	1.76	2.75
5000.00	5030.00	8.24	36.41	19.92	2.09	2.09
5100.00	5130.00	8.18	38.17	20.34	2.05	2.18
5200.00	5230.00	8.20	40.26	20.55	1.86	2.33
5300.00	5330.00	8.25	42.62	20.82	1.65	2.57
5400.00	5430.00	8.34	43.72	21.01	1.60	2.77
5500.00	5530.00	8.43	42.20	21.03	1.76	2.76
5600.00	5630.00	8.60	39.70	21.01	2.11	2.84
5700.00	5730.00	8.76	37.69	21.00	2.61	2.88
5800.00	5830.00	8.85	36.36	20.92	2.89	2.84
6000.00	6030.00	9.28	34.92	20.45	2.77	2.19

Electrical Schematic

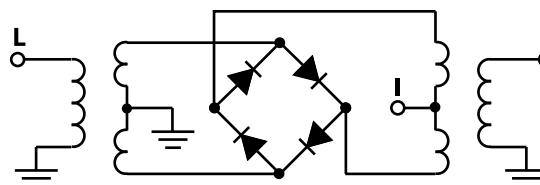

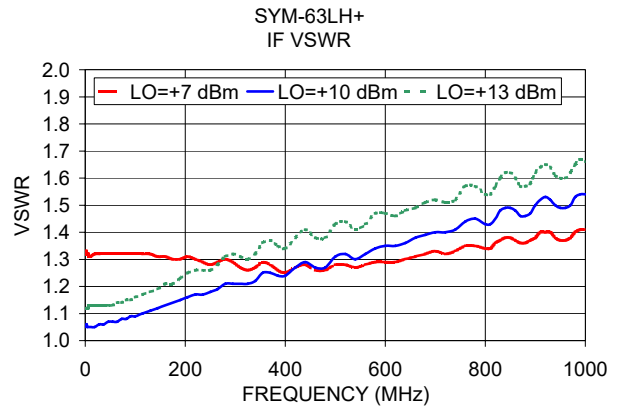
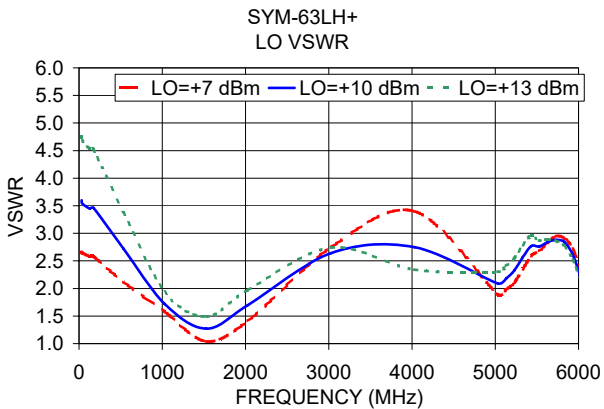
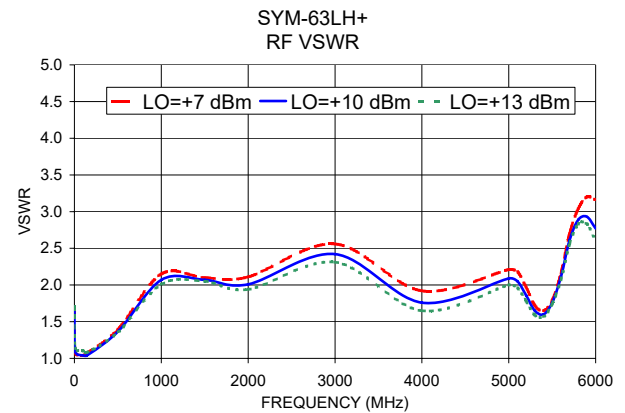
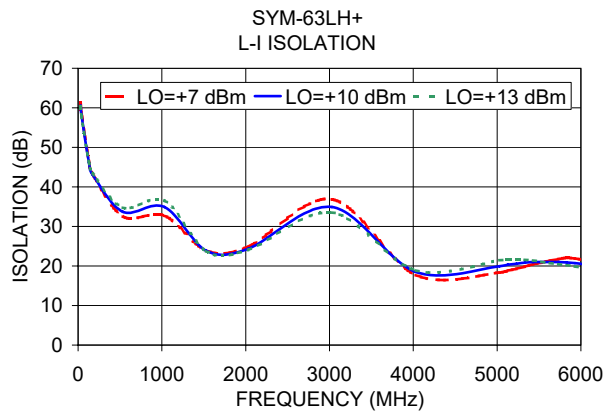
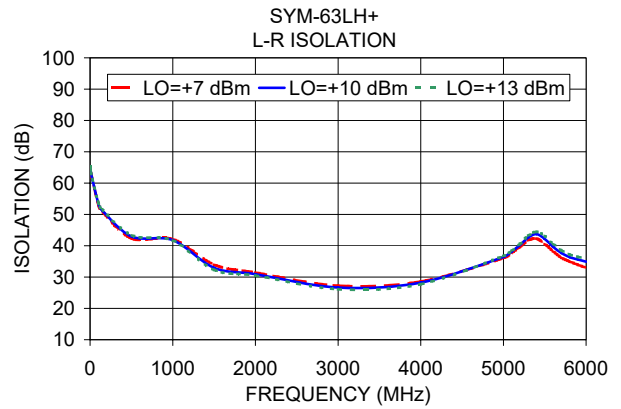
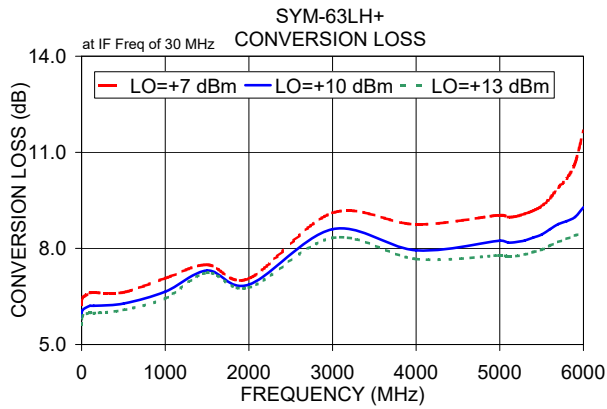

Notes

- A. Performance and quality attributes and conditions not expressly stated in this specification document are intended to be excluded and do not form a part of this specification document.
- B. Electrical specifications and performance data contained in this specification document are based on Mini-Circuit's applicable established test performance criteria and measurement instructions.
- C. The parts covered by this specification document are subject to Mini-Circuits standard limited warranty and terms and conditions (collectively, "Standard Terms"); Purchasers of this part are entitled to the rights and benefits contained therein. For a full statement of the Standard Terms and the exclusive rights and remedies thereunder, please visit Mini-Circuits' website at www.minicircuits.com/MCLStore/terms.jsp



Frequency Mixer

SYM-63LH+

Typical Performance Data

RF (IN) (MHz)	LO (MHz)	CONVERSION LOSS IF FIXED @IF(OUT)=30.1MHz (dB)			RF (IN) (MHz)	LO (MHz)	IP-3 INPUT (dBm)			RF (IN) (MHz)	LO (MHz)	COMPRESSION @RF IN=+3dBm (dB)		
		@LO (dBm)					@LO (dBm)					@LO (dBm)		
		+7	+10	+13			+7	+10	+13			+7	+10	+13
0.9	30.9	7.45	7.02	6.81	0.9	30.9	15.55	17.77	18.80	0.9	30.9	0.66	0.42	0.24
1.1	31.1	7.23	6.82	6.60	1.1	31.1	15.49	17.58	18.85	2.0	32.1	1.00	0.69	0.43
5.1	35.1	6.47	6.10	5.92	5.1	35.1	16.58	18.43	19.22	5.0	35.1	1.21	0.87	0.57
9.1	39.1	6.42	6.05	5.87	9.1	39.1	16.67	17.79	18.34	9.0	39.1	1.26	0.90	0.61
52.0	82.1	6.46	6.08	5.89	52.0	82.1	13.15	13.95	14.83	52.0	82.1	1.39	1.05	0.75
100.0	130.1	6.52	6.16	5.97	100.0	130.1	12.34	13.27	14.08	100.0	130.1	1.45	1.10	0.79
300.0	330.1	6.65	6.25	6.03	300.0	330.1	12.56	16.72	21.85	300.0	330.1	1.53	1.21	0.92
500.0	530.1	6.70	6.35	6.14	500.0	530.1	17.37	17.29	17.19	500.0	530.1	1.52	1.21	0.92
650.0	680.1	6.63	6.29	6.10	650.0	680.1	15.54	15.67	16.12	650.0	680.1	1.61	1.31	1.00
850.0	880.1	6.78	6.44	6.26	850.0	880.1	17.93	17.29	16.48	850.0	880.1	1.78	1.44	1.12
1050.0	1080.1	7.25	6.82	6.58	1050.0	1080.1	10.93	12.93	14.46	1050.0	1080.1	1.49	1.20	0.91
1200.0	1230.1	7.58	7.28	7.09	1200.0	1230.1	9.41	10.40	11.46	1200.0	1230.1	1.15	0.86	0.63
1400.0	1430.1	7.49	7.29	7.20	1400.0	1430.1	12.53	13.17	13.38	1400.0	1430.1	0.91	0.68	0.50
1600.0	1630.1	7.35	7.20	7.14	1600.0	1630.1	16.92	15.99	15.41	1600.0	1630.1	0.76	0.59	0.47
1750.0	1780.1	7.11	6.94	6.86	1750.0	1780.1	17.63	18.40	17.93	1750.0	1780.1	0.81	0.63	0.50
1950.0	1980.1	7.26	7.08	6.99	1950.0	1980.1	17.51	18.39	19.98	1950.0	1980.1	0.85	0.62	0.47
2150.0	2180.1	7.44	7.18	7.03	2150.0	2180.1	17.75	19.09	20.72	2150.0	2180.1	1.09	0.83	0.65
2300.0	2330.1	8.06	7.67	7.47	2300.0	2330.1	19.14	20.53	19.92	2300.0	2330.1	1.03	0.82	0.64
2500.0	2530.1	8.85	8.26	7.89	2500.0	2530.1	18.01	20.79	19.68	2500.0	2530.1	0.91	0.81	0.69
2700.0	2730.1	9.23	8.65	8.27	2700.0	2730.1	13.82	14.02	14.43	2700.0	2730.1	0.86	0.76	0.67
2850.0	2880.1	9.11	8.60	8.27	2850.0	2880.1	12.11	12.06	12.02	2850.0	2880.1	1.06	0.89	0.78
3050.0	3080.1	9.04	8.58	8.37	3050.0	3080.1	11.45	11.76	11.42	3050.0	3080.1	1.09	0.90	0.76
3250.0	3280.1	8.83	8.36	8.19	3250.0	3280.1	11.39	14.56	15.03	3250.0	3280.1	1.26	0.95	0.80
3400.0	3430.1	9.06	8.50	8.33	3400.0	3430.1	11.15	15.20	15.44	3400.0	3430.1	1.04	0.79	0.69
3600.0	3630.1	9.17	8.40	8.20	3600.0	3630.1	12.21	13.56	15.02	3600.0	3630.1	0.97	0.74	0.65
3800.0	3830.1	8.91	8.22	8.04	3800.0	3830.1	13.13	13.60	14.23	3800.0	3830.1	0.86	0.64	0.55
3950.0	3980.1	9.32	8.22	7.88	3950.0	3980.1	12.62	13.94	13.73	3950.0	3980.1	0.96	0.67	0.53
4150.0	4180.1	8.82	7.94	7.63	4150.0	4180.1	13.22	14.08	14.43	4150.0	4180.1	0.90	0.57	0.44
4350.0	4380.1	8.57	7.83	7.54	4350.0	4380.1	14.47	14.47	14.77	4350.0	4380.1	0.88	0.52	0.36
4500.0	4530.1	8.48	7.74	7.45	4500.0	4530.1	15.04	16.60	16.33	4500.0	4530.1	1.05	0.57	0.36
4700.0	4730.1	8.73	7.98	7.63	4700.0	4730.1	13.33	18.04	17.44	4700.0	4730.1	1.01	0.58	0.40
4900.0	4930.1	9.06	8.27	7.84	4900.0	4930.1	17.74	25.34	22.47	4900.0	4930.1	1.07	0.68	0.52
5050.0	5080.1	9.17	8.40	7.96	5050.0	5080.1	15.58	14.77	14.98	5050.0	5080.1	1.07	0.70	0.53
5250.0	5280.1	9.08	8.34	7.93	5250.0	5280.1	12.37	12.37	12.71	5250.0	5280.1	1.37	0.88	0.67
5450.0	5480.1	9.49	8.66	8.22	5450.0	5480.1	11.26	12.27	13.25	5450.0	5480.1	1.50	0.85	0.63
5600.0	5630.1	9.46	8.52	8.05	5600.0	5630.1	9.83	12.17	14.30	5600.0	5630.1	2.09	1.15	0.81
5800.0	5830.1	9.84	8.60	8.08	5800.0	5830.1	7.67	11.21	14.97	5800.0	5830.1	2.43	1.40	0.88
6000.0	6030.1	11.27	9.04	8.36	6000.0	6030.1	7.58	9.30	12.83	6000.0	6030.1	2.09	1.70	0.80



Frequency Mixer

SYM-63LH+

Typical Performance Data

IF (OUT) (MHz)	LO (MHz)	CONVERSION LOSS VS. IF FREQUENCY @RF(IN)=3000.5MHz (dB)
		@LO (dBm)
		+10
741.5	2259.0	10.26
701.5	2299.0	10.10
666.5	2334.0	10.04
626.5	2374.0	10.02
586.5	2414.0	9.79
546.5	2454.0	9.77
511.5	2489.0	9.63
471.5	2529.0	9.47
431.5	2569.0	9.40
391.5	2609.0	9.26
356.5	2644.0	9.13
316.5	2684.0	9.08
276.5	2724.0	8.96
236.5	2764.0	8.97
201.5	2799.0	8.89
161.5	2839.0	8.88
121.5	2879.0	8.84
81.5	2919.0	8.77
46.5	2954.0	8.73
6.5	2994.0	8.37
0.3	3000.8	8.31
21.5	3022.0	8.67
61.5	3062.0	8.65
96.5	3097.0	8.68
136.5	3137.0	8.75
171.5	3172.0	8.78
206.5	3207.0	8.86
246.5	3247.0	8.90
281.5	3282.0	8.97
316.5	3317.0	9.10
356.5	3357.0	9.13
391.5	3392.0	9.29
431.5	3432.0	9.41
466.5	3467.0	9.42
501.5	3502.0	9.56
541.5	3542.0	9.71
576.5	3577.0	9.70
616.5	3617.0	9.93
651.5	3652.0	10.00
686.5	3687.0	10.10

IF (OUT) (MHz)	LO (MHz)	CONVERSION LOSS VS. IF FREQUENCY @RF(IN)=10.1MHz (dB)
		@LO (dBm)
		+10
0.3	10.4	5.51
1.9	12.0	5.69
41.9	52.0	5.99
71.9	82.0	5.92
111.9	122.0	6.04
151.9	162.0	6.05
191.9	202.0	6.08
221.9	232.0	6.19
261.9	272.0	6.21
301.9	312.0	6.32
341.9	352.0	6.34
371.9	382.0	6.34
411.9	422.0	6.52
451.9	462.0	6.55
491.9	502.0	6.66
531.9	542.0	6.74
561.9	572.0	6.71
601.9	612.0	6.88
641.9	652.0	6.97
681.9	692.0	7.07
711.9	722.0	7.15
751.9	762.0	7.29
791.9	802.0	7.32
831.9	842.0	7.48
861.9	872.0	7.56
901.9	912.0	7.67
941.9	952.0	7.88
981.9	992.0	8.00
1021.9	1032.0	8.24
1051.9	1062.0	8.38
1091.9	1102.0	8.61
1131.9	1142.0	8.87
1171.9	1182.0	9.06
1201.9	1212.0	9.29
1241.9	1252.0	9.57
1281.9	1292.0	9.81
1321.9	1332.0	10.20
1351.9	1362.0	10.44
1391.9	1402.0	10.85
1421.9	1432.0	11.23

IF (OUT) (MHz)	LO (MHz)	CONVERSION LOSS VS. IF FREQUENCY @RF(IN)=6000.1MHz (dB)
		@LO (dBm)
		+10
991.1	5009.0	10.45
961.1	5039.0	10.32
941.1	5059.0	10.27
911.1	5089.0	10.21
881.1	5119.0	10.08
861.1	5139.0	10.01
831.1	5169.0	9.93
801.1	5199.0	9.87
781.1	5219.0	9.81
751.1	5249.0	9.73
721.1	5279.0	9.68
701.1	5299.0	9.63
671.1	5329.0	9.58
641.1	5359.0	9.51
621.1	5379.0	9.45
591.1	5409.0	9.37
561.1	5439.0	9.37
541.1	5459.0	9.34
511.1	5489.0	9.31
481.1	5519.0	9.30
461.1	5539.0	9.29
431.1	5569.0	9.26
401.1	5599.0	9.26
381.1	5619.0	9.21
351.1	5649.0	9.18
321.1	5679.0	9.19
301.1	5699.0	9.18
271.1	5729.0	9.02
241.1	5759.0	9.06
221.1	5779.0	9.09
191.1	5809.0	9.00
161.1	5839.0	8.85
141.1	5859.0	8.99
111.1	5889.0	9.04
81.1	5919.0	8.95
61.1	5939.0	8.87
31.1	5969.0	9.12
1.1	5999.0	8.99
0.8	5999.3	9.02
0.4	5999.7	8.92



P.O. Box 350166, Brooklyn, New York 11235-0003 (718) 934-4500 • Fax (718) 332-4661 For detailed performance specs & shopping online see Mini-Circuits web site www.minicircuits.com



The Design Engineers Search Engine Provides ACTUAL Data Instantly From MINI-CIRCUITS At: www.minicircuits.com

IF/RF MICROWAVE COMPONENTS

REV. X2

SYM-63LH+

10/4/2010

Page 2 of 5

Typical Performance Data

LO (MHz)	LO-RF ISOLATION (dB)			LO-IF ISOLATION (dB)		
	@LO (dBm)			@LO (dBm)		
	+7	+10	+13	+7	+10	+13
30.9	65.72	65.35	65.20	61.60	60.92	60.39
32.0	65.25	65.08	65.02	61.32	60.53	60.20
35.0	64.40	64.30	64.33	60.40	60.00	59.37
39.0	63.17	63.25	63.38	59.59	58.69	58.34
82.0	56.63	56.87	57.26	52.02	51.30	50.97
130.0	52.42	52.88	53.46	46.80	46.39	46.46
330.0	45.26	46.16	46.94	36.69	37.49	38.32
530.0	42.02	42.87	43.62	32.85	34.05	35.06
680.0	40.96	41.73	42.13	31.93	33.47	34.68
880.0	40.31	41.05	41.59	31.51	33.85	36.15
1080.0	44.14	43.48	42.90	32.21	34.08	35.20
1230.0	40.28	39.20	38.44	28.81	29.72	29.97
1430.0	36.04	34.97	34.15	24.75	24.97	24.96
1630.0	33.04	32.15	31.27	23.26	23.12	22.96
1780.0	32.02	31.23	30.42	23.35	23.08	22.85
1980.0	31.52	30.85	30.07	24.37	24.01	23.72
2180.0	30.93	30.51	30.02	26.01	25.51	25.14
2330.0	30.16	29.73	29.36	27.18	26.60	26.16
2530.0	29.43	28.84	28.34	29.39	28.82	28.40
2730.0	28.01	27.31	26.78	32.19	31.70	31.39
2880.0	27.68	27.01	26.47	36.35	35.40	34.63
3080.0	26.85	26.32	25.88	34.73	32.86	31.69
3280.0	27.17	26.71	26.36	27.49	26.65	26.04
3430.0	26.41	25.91	25.53	23.52	23.03	22.49
3630.0	27.12	26.59	26.15	20.60	20.49	20.26
3830.0	27.03	26.73	26.48	18.28	18.61	18.72
3980.0	28.78	28.25	27.76	18.35	18.93	19.24
4180.0	29.19	28.88	28.34	17.25	18.23	18.93
4380.0	29.83	29.81	29.40	16.88	18.25	19.36
4530.0	30.88	31.00	30.82	16.98	18.61	20.05
4730.0	32.24	32.49	32.56	16.99	18.68	20.34
4930.0	34.63	34.96	35.03	17.53	19.22	20.84
5080.0	36.89	37.21	37.33	18.06	19.60	21.00
5280.0	41.43	42.08	42.43	18.98	20.08	20.97
5480.0	41.05	43.08	44.32	20.09	20.43	20.63
5630.0	37.12	38.73	39.88	20.88	20.57	20.30
5830.0	33.56	34.99	35.94	21.43	20.42	19.70
6030.0	31.45	33.24	34.48	21.27	20.19	19.31

RF (IN) (MHz)	LO (MHz)	RF-IF ISOLATION (dB)		
		@LO (dBm)		
		+7	+10	+13
0.9	30.9	47.70	50.62	53.55
2.0	32.0	46.89	49.61	53.59
5.0	35.0	46.41	48.14	50.76
9.0	39.0	45.54	47.71	50.63
52.0	82.0	43.52	42.69	41.55
100.0	130.0	38.97	37.66	36.56
300.0	330.0	30.95	29.60	28.96
500.0	530.0	28.71	27.66	27.01
650.0	680.0	29.42	27.74	26.69
850.0	880.0	31.01	29.03	27.81
1050.0	1080.0	21.56	21.36	21.07
1200.0	1230.0	17.90	17.70	17.57
1400.0	1430.0	15.76	15.50	15.28
1600.0	1630.0	15.98	15.76	15.57
1750.0	1780.0	16.95	16.82	16.73
1950.0	1980.0	19.25	19.19	19.15
2150.0	2180.0	21.23	21.21	21.18
2300.0	2330.0	22.85	22.78	22.74
2500.0	2530.0	24.37	24.23	24.15
2700.0	2730.0	25.16	24.96	24.83
2850.0	2880.0	24.48	24.23	24.04
3050.0	3080.0	23.26	22.93	22.62
3250.0	3280.0	21.81	21.41	21.09
3400.0	3430.0	21.34	20.90	20.59
3600.0	3630.0	21.12	20.54	20.11
3800.0	3830.0	21.40	20.91	20.44
3950.0	3980.0	21.61	21.37	21.02
4150.0	4180.0	22.00	21.74	21.46
4350.0	4380.0	22.66	22.47	22.12
4500.0	4530.0	23.30	23.37	23.22
4700.0	4730.0	24.51	25.07	25.39
4900.0	4930.0	25.67	26.69	27.63
5050.0	5080.0	26.33	27.39	28.10
5250.0	5280.0	26.32	27.17	27.77
5450.0	5480.0	26.62	27.14	27.60
5600.0	5630.0	26.39	26.80	26.96
5800.0	5830.0	26.27	26.06	26.03
6000.0	6030.0	27.33	26.64	26.34

Frequency Mixer

SYM-63LH+

Typical Performance Data

RF (IN) (MHz)	LO (MHz)	RF VSWR (:1)			LO (MHz)	LO VSWR (:1)			IF (OUT) (MHz)	IF VSWR @LO=6000.1MHz (:1)		
		@LO (dBm)				@LO (dBm)				@LO (dBm)		
		+7	+10	+13		+7	+10	+13		+7	+10	+13
0.9	30.9	1.89	1.90	1.92	30.9	2.93	4.22	6.05	0.3	2.64	1.55	1.15
2.0	32.0	1.41	1.43	1.46	32.0	2.93	4.21	6.03	2.0	2.61	1.53	1.15
5.0	35.0	1.15	1.17	1.21	35.0	2.92	4.18	5.99	6.0	2.63	1.55	1.15
9.0	39.0	1.08	1.10	1.15	39.0	2.89	4.14	5.88	10.0	2.65	1.56	1.16
52.0	82.0	1.04	1.04	1.11	82.0	2.67	3.66	4.92	68.0	2.59	1.55	1.18
100.0	130.0	1.06	1.02	1.08	130.0	2.56	3.47	4.58	120.0	2.52	1.53	1.17
300.0	330.0	1.22	1.17	1.16	330.0	2.28	3.00	3.83	160.0	2.49	1.52	1.19
500.0	530.0	1.45	1.41	1.39	530.0	2.05	2.61	3.22	210.0	2.42	1.49	1.18
650.0	680.0	1.58	1.54	1.51	680.0	1.88	2.29	2.77	250.0	2.39	1.49	1.19
850.0	880.0	1.87	1.79	1.75	880.0	1.66	1.90	2.21	290.0	2.33	1.47	1.19
1050.0	1080.0	2.19	2.12	2.06	1080.0	1.47	1.59	1.78	330.0	2.25	1.43	1.19
1200.0	1230.0	2.22	2.18	2.15	1230.0	1.31	1.39	1.56	370.0	2.21	1.43	1.20
1400.0	1430.0	2.12	2.10	2.08	1430.0	1.09	1.23	1.43	410.0	2.13	1.38	1.19
1600.0	1630.0	2.10	2.06	2.04	1630.0	1.07	1.31	1.54	450.0	2.07	1.37	1.22
1750.0	1780.0	2.13	2.06	2.02	1780.0	1.20	1.46	1.71	490.0	2.02	1.35	1.21
1950.0	1980.0	2.19	2.08	2.01	1980.0	1.38	1.68	1.96	530.0	1.94	1.32	1.23
2150.0	2180.0	2.39	2.26	2.17	2180.0	1.61	1.92	2.22	570.0	1.89	1.32	1.25
2300.0	2330.0	2.56	2.42	2.32	2330.0	1.82	2.11	2.41	610.0	1.80	1.27	1.25
2500.0	2530.0	2.79	2.63	2.51	2530.0	2.09	2.33	2.60	650.0	1.73	1.26	1.27
2700.0	2730.0	2.76	2.61	2.49	2730.0	2.35	2.51	2.73	690.0	1.68	1.24	1.27
2850.0	2880.0	2.67	2.54	2.43	2880.0	2.48	2.55	2.72	740.0	1.58	1.22	1.31
3050.0	3080.0	2.51	2.38	2.27	3080.0	2.64	2.55	2.62	780.0	1.55	1.21	1.30
3250.0	3280.0	2.37	2.23	2.12	3280.0	2.96	2.62	2.53	820.0	1.48	1.20	1.33
3400.0	3430.0	2.30	2.14	2.05	3430.0	3.17	2.69	2.49	860.0	1.45	1.19	1.33
3600.0	3630.0	2.19	2.00	1.90	3630.0	3.42	2.82	2.47	900.0	1.40	1.20	1.35
3800.0	3830.0	2.04	1.87	1.77	3830.0	3.31	2.73	2.34	940.0	1.37	1.18	1.34
3950.0	3980.0	2.07	1.87	1.73	3980.0	3.51	2.85	2.37	1000.0	1.32	1.20	1.36
4150.0	4180.0	1.85	1.69	1.59	4180.0	3.16	2.65	2.29	1020.0	1.30	1.19	1.36
4350.0	4380.0	1.72	1.59	1.51	4380.0	2.84	2.55	2.36	1060.0	1.28	1.18	1.34
4500.0	4530.0	1.63	1.49	1.41	4530.0	2.63	2.50	2.46	1100.0	1.27	1.18	1.34
4700.0	4730.0	1.64	1.51	1.43	4730.0	2.36	2.42	2.55	1140.0	1.25	1.17	1.32
4900.0	4930.0	1.83	1.73	1.66	4930.0	2.22	2.42	2.63	1180.0	1.23	1.17	1.32
5050.0	5080.0	1.89	1.80	1.74	5080.0	2.23	2.47	2.70	1220.0	1.22	1.14	1.28
5250.0	5280.0	2.03	1.96	1.92	5280.0	2.28	2.48	2.67	1270.0	1.23	1.11	1.23
5450.0	5480.0	2.34	2.27	2.21	5480.0	2.38	2.48	2.58	1310.0	1.24	1.10	1.19
5600.0	5630.0	2.27	2.16	2.08	5630.0	2.47	2.48	2.51	1350.0	1.26	1.09	1.15
5800.0	5830.0	2.54	2.39	2.31	5830.0	2.53	2.45	2.41	1390.0	1.28	1.11	1.13
6000.0	6030.0	2.81	2.50	2.40	6030.0	2.54	2.45	2.37	1430.0	1.31	1.13	1.11



P.O. Box 350166, Brooklyn, New York 11235-0003 • Fax (718) 934-4500 • Fax (718) 332-4661 For detailed performance specs & shopping online see Mini-Circuits web site www.minicircuits.com



The Design Engineers Search Engine Provides ACTUAL Data Instantly From MINI-CIRCUITS At: www.minicircuits.com

IF/RF MICROWAVE COMPONENTS

REV. X2

SYM-63LH+

10/4/2010

Page 4 of 5

Harmonics Tables

RF HARMONICS ORDER

	(-dBm)	(-dBc)										
0	---	---	6.46	22.00	13.18	39.04	29.66	45.61	38.99	59.01	---	---
1	---	15.46	---	43.26	27.45	40.02	52.64	38.28	49.88	55.19	60.07	---
2	113.32	52.56	54.17	63.68	54.87	57.19	52.54	59.18	60.92	75.36	58.62	83.97
3	129.52	69.67	61.48	68.24	55.61	65.89	73.86	69.84	72.32	61.12	72.39	76.22
4	129.37	92.58	97.04	87.67	88.10	71.26	84.63	80.86	85.88	79.90	76.98	96.73
5	126.77	100.42	106.54	101.61	93.68	97.15	82.96	91.12	97.35	96.96	91.86	82.54
6	124.76	103.85	103.16	106.44	107.83	106.51	107.94	98.16	104.68	106.28	106.98	98.90
7	123.22	101.62	105.09	105.60	107.58	109.34	106.16	107.22	100.77	105.48	107.56	109.46
8	122.27	98.84	100.86	104.25	105.46	106.54	106.63	107.58	108.17	104.61	105.86	106.85
9	123.27	---	96.41	101.69	104.58	104.81	106.83	108.45	107.75	106.84	106.39	105.58
10	122.27	---	---	99.76	101.51	104.86	103.50	105.67	107.08	106.68	107.33	106.56
	RF CAL	0	1	2	3	4	5	6	7	8	9	10

LO HARMONICS ORDER

Test conditions: RF IN: 3000 MHz; -10.00 dBm
 LO IN: 3030 MHz; +10.00 dBm
 IF OUT: 30 MHz; -18.44 dBm

RF HARMONICS ORDER

	(-dBm)	(-dBc)										
0	---	---	17.00	30.70	24.98	68.89	42.20	68.75	46.23	72.44	---	---
1	---	14.58	---	43.90	28.09	47.15	48.56	50.81	63.72	70.22	69.80	---
2	102.93	43.63	43.71	34.51	46.45	42.94	49.19	52.79	66.06	67.98	61.71	96.97
3	119.13	48.13	41.53	49.75	38.36	54.12	69.92	57.85	64.47	56.09	67.43	72.92
4	118.98	73.63	75.55	73.51	61.79	46.59	57.64	57.23	60.90	64.18	68.15	72.57
5	116.38	62.44	67.74	68.67	63.94	65.68	62.02	64.74	71.44	66.97	76.18	64.38
6	114.37	86.47	80.58	80.97	79.73	69.51	72.68	53.69	70.45	68.09	74.05	73.58
7	112.83	80.85	85.75	71.80	86.62	85.54	75.86	85.87	69.84	79.55	80.21	80.36
8	111.88	100.23	90.31	98.51	87.30	96.08	91.28	76.87	80.85	65.12	77.37	79.51
9	112.88	---	102.78	93.94	95.99	83.43	93.13	94.46	82.74	94.52	76.99	82.49
10	111.88	---	---	109.04	104.90	103.14	90.56	101.95	105.13	85.56	89.79	76.40
	RF CAL	0	1	2	3	4	5	6	7	8	9	10

LO HARMONICS ORDER

Test conditions: RF IN: 3000 MHz; 0.00 dBm
 LO IN: 3030 MHz; +10.00 dBm
 IF OUT: 30 MHz; -8.05 dBm

- Notes:
1. All Harmonics are in (dBc) relative to IF OUTPUT
 2. + entry denotes harmonics are in (dBc) above IF OUTPUT
 3. RF Cal represents the Harmonics level of the RF Input Signal to the mixer



Typical Performance Curves

Conversion Loss @IF=30.1 MHz

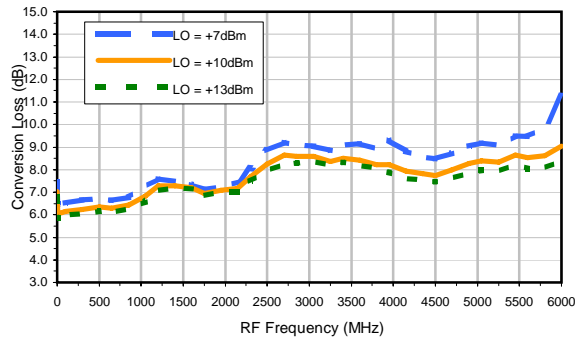

Conversion Loss vs. LO @ RF=3000.5 MHz

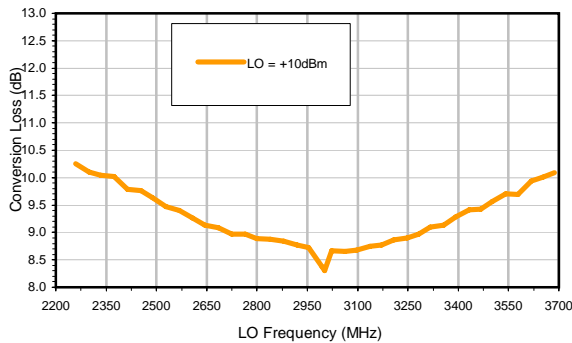

Conversion Loss vs. IF @ RF=3000.5 MHz

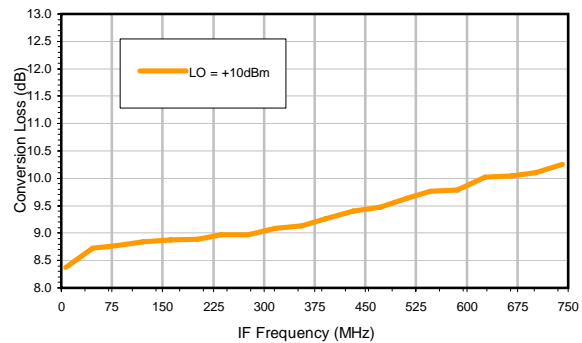

Conversion Loss vs. IF @ RF=10.1 MHz

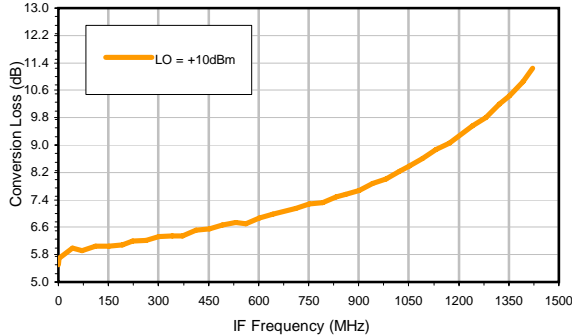

Conversion Loss vs. IF @ RF=6000.1 MHz

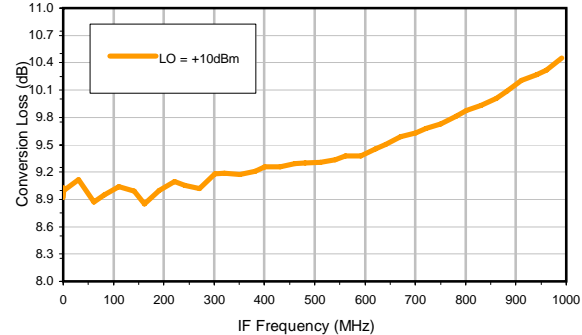

IP-3 Input

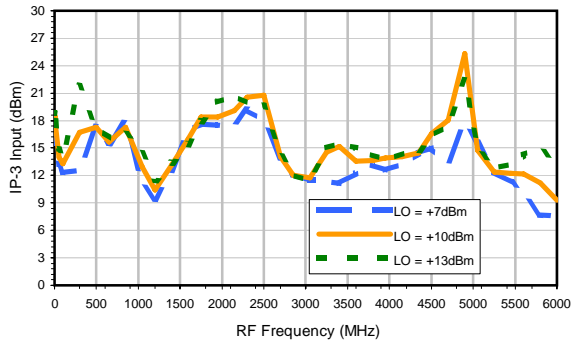

Compression @RF IN=+3 dBm

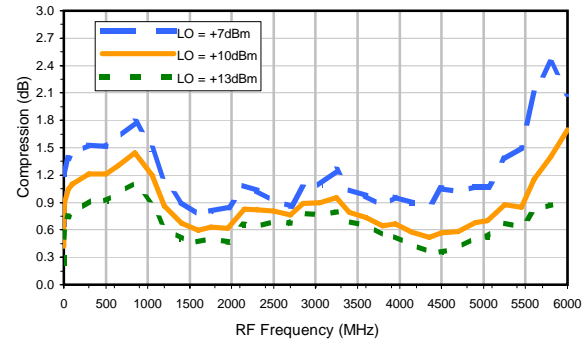

Typical Performance Curves

LO-RF Isolation

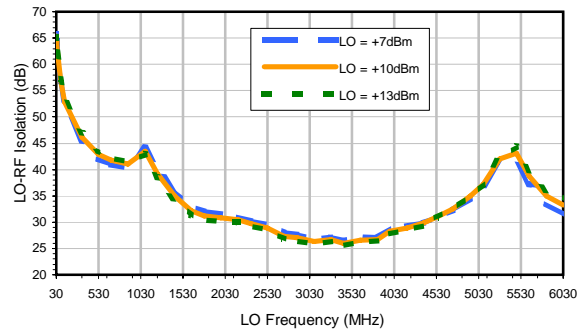

LO-IF Isolation

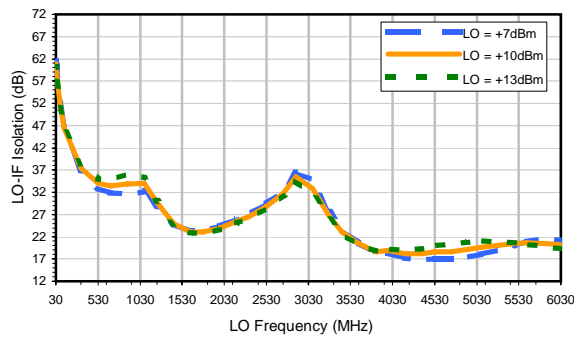

RF-IF Isolation

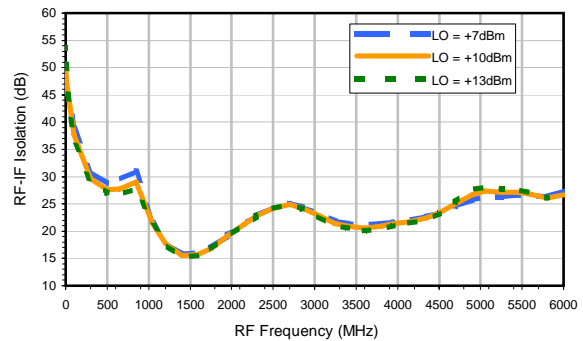

RF VSWR

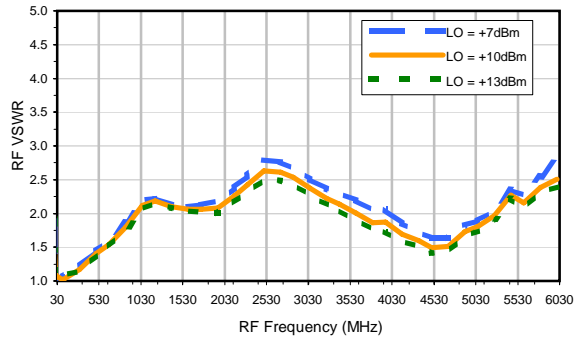

LO VSWR

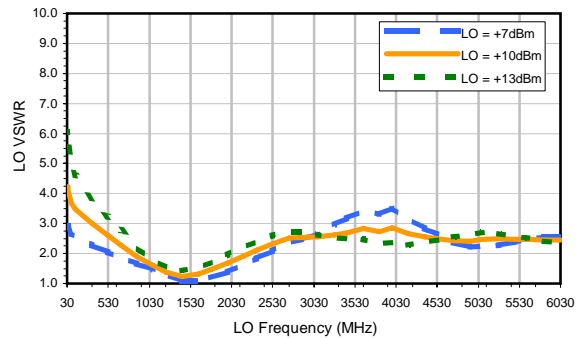

IF VSWR

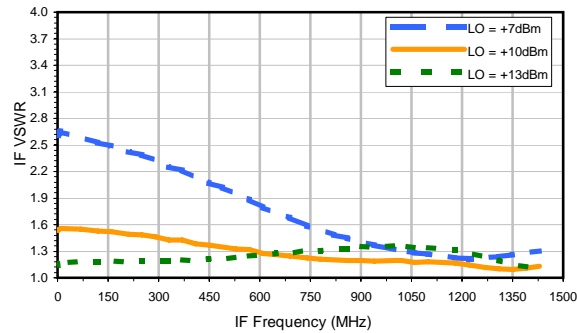

Harmonics Tables

RF HARMONICS ORDER

	(-dBm)	(-dBc)										
0	---	---	6.46	22.00	13.18	39.04	29.66	45.61	38.99	59.01	---	---
1	---	15.46	---	43.26	27.45	40.02	52.64	38.28	49.88	55.19	60.07	---
2	113.32	52.56	54.17	63.68	54.87	57.19	52.54	59.18	60.92	75.36	58.62	83.97
3	129.52	69.67	61.48	68.24	55.61	65.89	73.86	69.84	72.32	61.12	72.39	76.22
4	129.37	92.58	97.04	87.67	88.10	71.26	84.63	80.86	85.88	79.90	76.98	96.73
5	126.77	100.42	106.54	101.61	93.68	97.15	82.96	91.12	97.35	96.96	91.86	82.54
6	124.76	103.85	103.16	106.44	107.83	106.51	107.94	98.16	104.68	106.28	106.98	98.90
7	123.22	101.62	105.09	105.60	107.58	109.34	106.16	107.22	100.77	105.48	107.56	109.46
8	122.27	98.84	100.86	104.25	105.46	106.54	106.63	107.58	108.17	104.61	105.86	106.85
9	123.27	---	96.41	101.69	104.58	104.81	106.83	108.45	107.75	106.84	106.39	105.58
10	122.27	---	---	99.76	101.51	104.86	103.50	105.67	107.08	106.68	107.33	106.56
	RF CAL	0	1	2	3	4	5	6	7	8	9	10

LO HARMONICS ORDER

Test conditions: RF IN: 3000 MHz; -10.00 dBm
 LO IN: 3030 MHz; +10.00 dBm
 IF OUT: 30 MHz; -18.44 dBm

RF HARMONICS ORDER

	(-dBm)	(-dBc)										
0	---	---	17.00	30.70	24.98	68.89	42.20	68.75	46.23	72.44	---	---
1	---	14.58	---	43.90	28.09	47.15	48.56	50.81	63.72	70.22	69.80	---
2	102.93	43.63	43.71	34.51	46.45	42.94	49.19	52.79	66.06	67.98	61.71	96.97
3	119.13	48.13	41.53	49.75	38.36	54.12	69.92	57.85	64.47	56.09	67.43	72.92
4	118.98	73.63	75.55	73.51	61.79	46.59	57.64	57.23	60.90	64.18	68.15	72.57
5	116.38	62.44	67.74	68.67	63.94	65.68	62.02	64.74	71.44	66.97	76.18	64.38
6	114.37	86.47	80.58	80.97	79.73	69.51	72.68	53.69	70.45	68.09	74.05	73.58
7	112.83	80.85	85.75	71.80	86.62	85.54	75.86	85.87	69.84	79.55	80.21	80.36
8	111.88	100.23	90.31	98.51	87.30	96.08	91.28	76.87	80.85	65.12	77.37	79.51
9	112.88	---	102.78	93.94	95.99	83.43	93.13	94.46	82.74	94.52	76.99	82.49
10	111.88	---	---	109.04	104.90	103.14	90.56	101.95	105.13	85.56	89.79	76.40
	RF CAL	0	1	2	3	4	5	6	7	8	9	10

LO HARMONICS ORDER

Test conditions: RF IN: 3000 MHz; 0.00 dBm
 LO IN: 3030 MHz; +10.00 dBm
 IF OUT: 30 MHz; -8.05 dBm

- Notes:
1. All Harmonics are in (dBc) relative to IF OUTPUT
 2. + entry denotes harmonics are in (dBc) above IF OUTPUT
 3. RF Cal represents the Harmonics level of the RF Input Signal to the mixer



Outline Dimensions

TTT166
TTT167

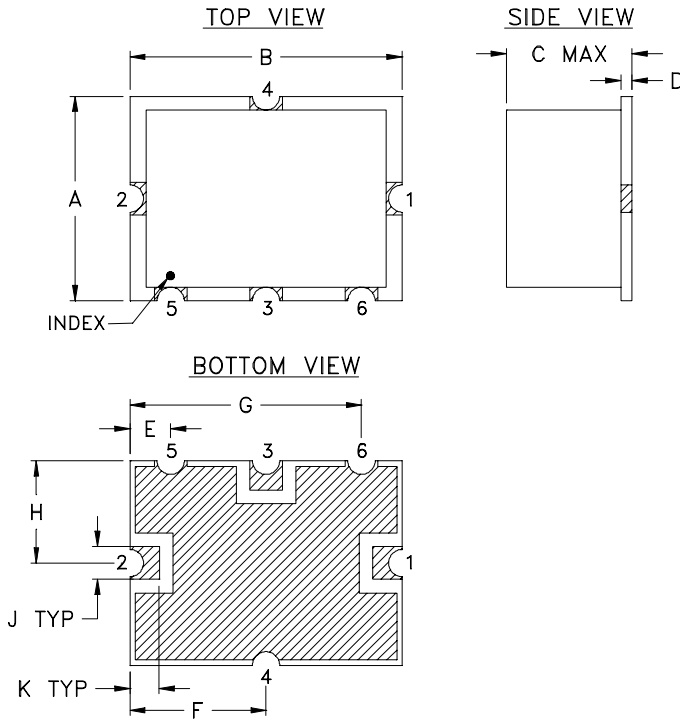

PCB Land Pattern

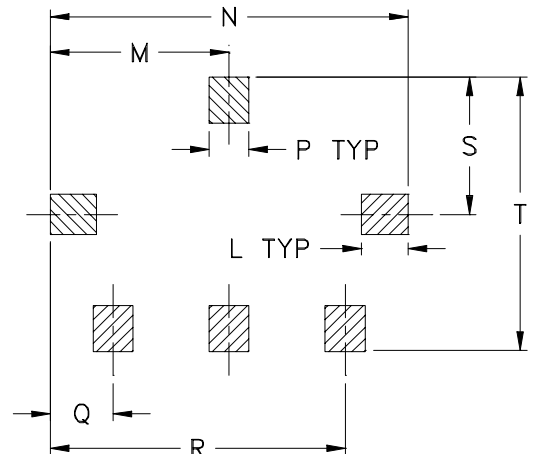

Suggested Layout,
Tolerance to be within $\pm .002$

CASE #	A	B	C	D	E	F	G	H	J	K	L	M	N
TTT166			.15 (3.81)										
TTT167	.38 (9.65)	.50 (12.70)	.23 (5.84)	.020 (0.51)	.075 (1.91)	.250 (6.35)	.425 (10.80)	.187 (4.75)	.050 (1.27)	.050 (1.27)	.070 (1.78)	.270 (6.86)	.540 (13.72)

CASE #	P	Q	R	S	T	WT. GRAM
TTT166	.060 (1.52)	.095 (2.41)	.445 (11.30)	.208 (5.28)	.415 (10.54)	.8
TTT167						.8

Dimensions are in inches (mm). Tolerances: 2 Pl. $\pm .01$; 3 Pl. $\pm .005$

Note:

- Case material: Plastic.
- Base material: Printed wiring laminate.
- Termination finish:
 - For RoHS Case Styles: 3-5 μ inch (.08-.13 microns) Gold over 120-240 μ inch (3.05-6.10 microns) Nickel plate. All models, (+) suffix.
 - For RoHS-5 Case Styles: Tin-Lead plate. All models, no (+) suffix.

Tape & Reel Packaging TR-F12

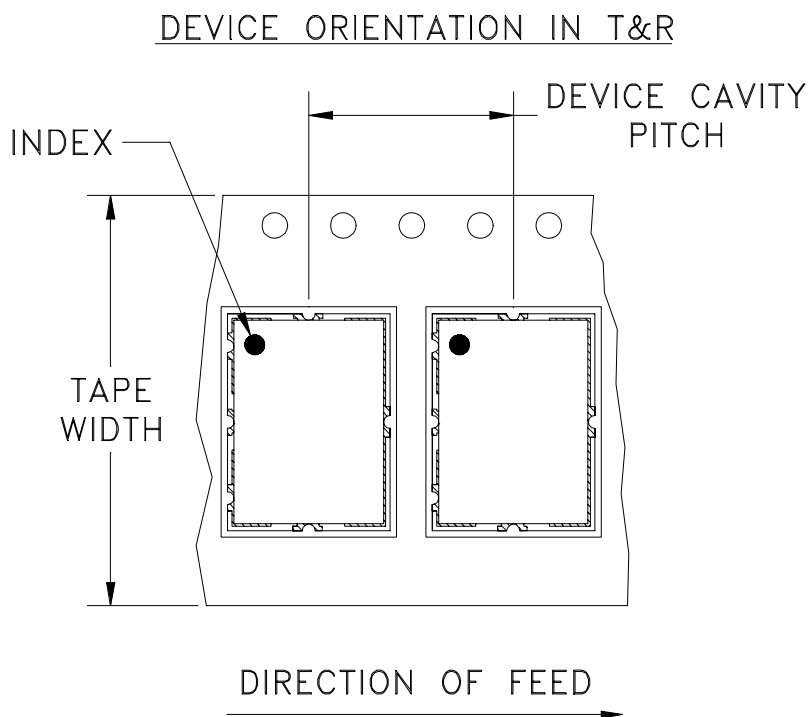

Tape Width, mm	Device Cavity Pitch, mm	Reel Size, inches	Devices per Reel	
24	12	7	Small quantity standards (see note)	10
				20
				50
				100
				200
		13	Standard	500

Note: Please Consult individual model data sheet to determine device per reel availability.

Mini-Circuits carrier tape materials provide protection from ESD (Electro-Static Discharge) during handling and transportation. Tapes are static dissipative and comply with industry standards EIA-481/EIA-541.

Go to: www.minicircuits.com/pages/pdfs/tape.pdf

Mini-Circuits[®]

Distribution Centers NORTH AMERICA 800-654-7949 • 417-335-5935 • Fax 417-335-5945 • EUROPE 44-1252-832600 • Fax 44-1252-837010

Mini-Circuits ISO 9001 & ISO 14001 Certified

INTERNET <http://www.minicircuits.com>

P.O. Box 350166, Brooklyn, New York 11235-0003 (718) 934-4500 Fax (718) 332-4661

THIRD ANGLE PROJECTION

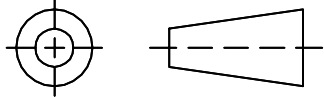

REVISIONS

REV	ECN No.	DESCRIPTION	DATE	DR	AUTH
A	M86762	ADDED CONNECTIONS "lp & lq"	05/23/03	MMG	WL
B	M94598	ADDED CONNECTION "hk"	10/08/04	MMG	HY
C	M102713	UPDATED NOTES & DESCRIPTION	01/14/06	GF	IL
D	M132989	UPDATED NOTE 2	08/24/11	GF	DJ

SUGGESTED MOUNTING CONFIGURATION FOR
TTT166/167 CASE STYLE, "hk"/"lp"/"lq"
"x"/"ck"/"ec" PIN CONNECTIONS

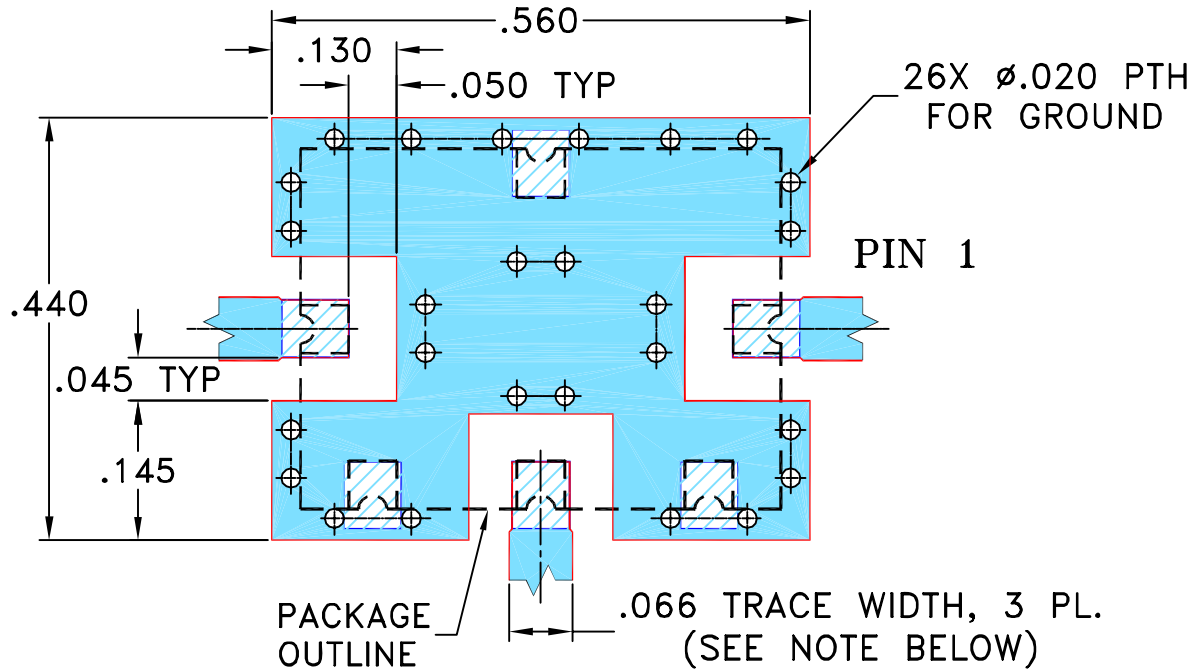

NOTE:

1. TRACE WIDTH IS SHOWN FOR ROGERS R04350B WITH DIELECTRIC THICKNESS .030" ± .002"; COPPER: 1/2 OZ. EACH SIDE. FOR OTHER MATERIALS TRACE WIDTH MAY NEED TO BE MODIFIED.
2. THE USE OF SOLDER MASK OVER THE GROUND AREA UNDER THE UNIT AS SHOWN IS RECOMMENDED TO PREVENT POTENTIAL SHORTING. IF USER CHOOSES TO EXPOSE METAL UNDER THE ENTIRE UNIT GROUND PAD FOR IMPROVED GROUNDING, IT IS RECOMMENDED A SOLDER MASK DAM BE APPLIED AROUND EACH GROUND PAD TO ENSURE FILLET AND CONNECTION AT GROUND PADS.
3. BOTTOM SIDE OF THE PCB IS CONTINUOUS GROUND PLANE.

 DENOTES PCB COPPER LAYOUT WITH SMOBC (SOLDER MASK OVER BARE COPPER), SEE NOTE 2.

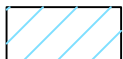
 DENOTES COPPER LAND PATTERN FREE OF SOLDER MASK

UNLESS OTHERWISE SPECIFIED

DIMENSIONS ARE IN INCHES
TOLERANCES ON:
2 PL DECIMALS ±
3 PL DECIMALS ± .005
ANGLES ±
FRACTIONS ±

	INITIALS	DATE
DRAWN	GF	03/18/03
CHECKED	IL	04/15/03
APPROVED	DJ	04/15/03



Mini-Circuits®

13 Neptune Avenue
Brooklyn NY 11235

PL, hk/lp/lq/x/ck/ec, TTT166/167,
SYM/HJK/SYAS/SYPD, TB-12

SIZE	CODE IDENT	DRAWING NO:	REV:
A	15542	98-PL-079	D
FILE:	98PL079	SCALE: 5:1	SHEET: 1 OF 1

Mini-Circuits®
THIS DOCUMENT AND ITS CONTENTS ARE THE PROPERTY OF MINI-CIRCUITS. EXCEPT FOR USE EXPRESSLY GRANTED, IN WRITING, TO ITS VENDORS, VENDEE AND THE UNITED STATES GOVERNMENT, MINI-CIRCUITS RESERVES ALL PROPRIETARY DESIGN, USE, MANUFACTURING AND REPRODUCTION RIGHTS THERETO. THESE CONTENTS SHALL NOT BE USED, DUPLICATED OR DISCLOSED TO ANY OUTSIDE PARTY, IN WHOLE OR IN PART, WITHOUT WRITTEN PERMISSION OF MINI-CIRCUITS.

Evaluation Board and Circuit

For Pin Connections Refer to Data Sheet of the DUT

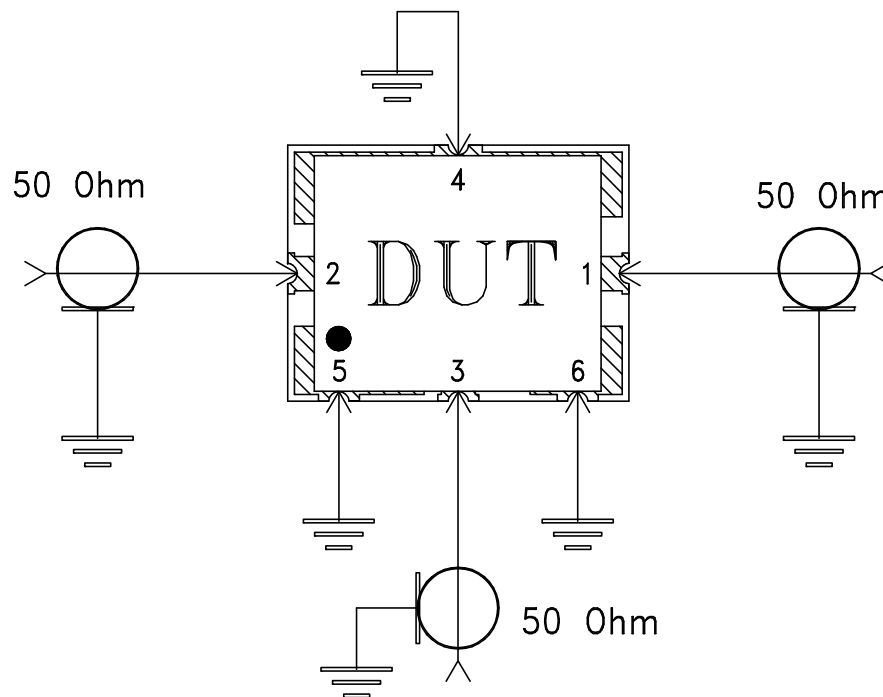
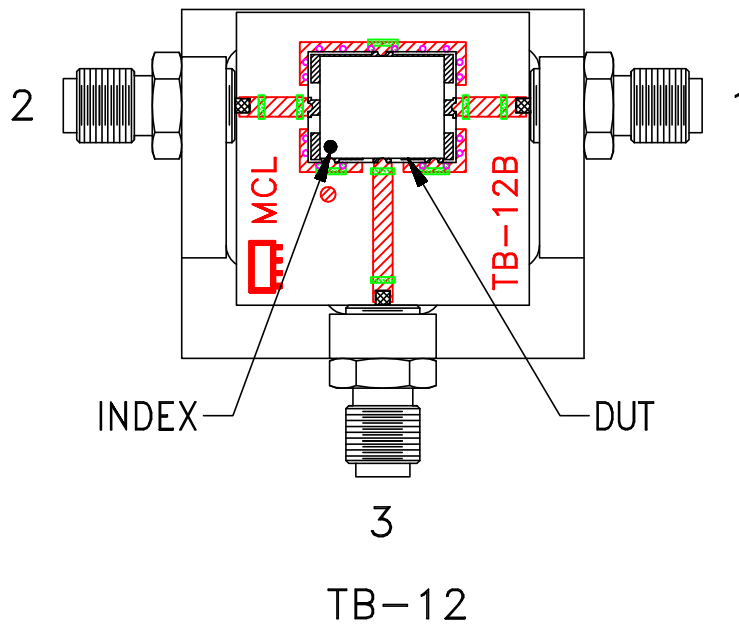

Schematic Diagram

Notes:

1. SMA Female connectors.
2. PCB Material: Rogers R04350 or equivalent, Dielectric Constant=3.5, Thickness=.030 inch.

 **Mini-Circuits®**

All Mini-Circuits products are manufactured under exacting quality assurance and control standards, and are capable of meeting published specifications after being subjected to any or all of the following physical and environmental test.

Specification	Test/Inspection Condition	Reference/Spec
Operating Temperature	-40° to 85°C Ambient Environment	Individual Model Data Sheet
Storage Temperature	-55° to 100° C Ambient Environment	Individual Model Data Sheet
Humidity	90 to 95% RH, 240 hours, 50°C	MIL-STD-202, Method 103, Condition A, Except 50°C and end-point electrical test done within 12 hours
Thermal Shock	-55° to 100°C, 100 cycles	MIL-STD-202, Method 107, Condition A-3, except +100°C
Solder Reflow Heat	Sn-Pb Eutetic Process: 225°C peak Pb-Free Process 245° - 250°C peak	J-STD-020, Table 4-1, 4-2 and 5-2, Figure 5-1
Solderability	10X Magnification	J-STD-002, 95% Coverage
Vibration (High Frequency)	20g peak, 10-2000 Hz, 12 times in each of three perpendicular directions (total 36)	MIL-STD-202, Method 204, Condition D
Mechanical Shock	50g, 11 ms, 1/2-sine, 18 shocks: 3 each direction, each of 3 axes	MIL-STD-202, Method 213, Condition A
Marking Resistance to Solvents	Isopropyl alcohol + mineral spirits at 25°C; terpene defluxer at 25°C; distilled water + proylene glycol monomethyl ether + monoethanolamine at 63°C to 70°C	MIL-STD-202, Method 215