

Surface Mount Bandpass Filter

SXBP-1500+

50Ω 1350 to 1650 MHz

The Big Deal

- Fast roll-off on the upper sideband
- Good Matching and low loss in the pass band
- Miniature shielded package

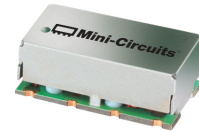

Generic photo used for illustration purposes only
CASE STYLE: HF1139

Product Overview

SXBP-1500+ is a wideband bandpass filter in a miniature shielded package covering 1350 to 1650 MHz. This is designed for asymmetric rejection applications such as super-heterodyne receivers. By having asymmetric band, faster roll-off at upper side band is achieved in a comparatively smaller package and lower pass band insertion loss. It has repeatable performance across lots and consistent performance across temperature

Key Features

Feature	Advantages
Fast roll-off on the upper side band	Wide bandwidth filter with fast-roll off on the upper side band, which increases selectivity on the adjacent channel.
Good matching and low loss in pass band	This filter has good matching and low loss in the pass band
High power handling	This model uses high Q capacitors and high current handling inductors which is well suited for high power applications.
Small size, 0.44" X 0.74" X 0.27"	The surface mount package enables the SXBP-1500+ to be used in compact designs.

Notes

- A. Performance and quality attributes and conditions not expressly stated in this specification document are intended to be excluded and do not form a part of this specification document.
B. Electrical specifications and performance data contained in this specification document are based on Mini-Circuit's applicable established test performance criteria and measurement instructions.
C. The parts covered by this specification document are subject to Mini-Circuits standard limited warranty and terms and conditions (collectively, "Standard Terms"); Purchasers of this part are entitled to the rights and benefits contained therein. For a full statement of the Standard Terms and the exclusive rights and remedies thereunder, please visit Mini-Circuits' website at www.minicircuits.com/MCLStore/terms.jsp



Surface Mount Bandpass Filter

50Ω 1350 to 1650 MHz

SXBP-1500+



Generic photo used for illustration purposes only
CASE STYLE: HF1139

Features

- Wide bandwidth
- Better rejection
- Miniature shielded package

Applications

- Aviation and Aeronautical
- Digital audio broadcasting
- Maritime
- Mobile satellite
- Radio astronomy
- Wireless medical telemetry

Functional Schematic

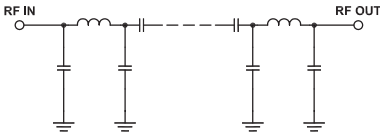

Typical Frequency Response

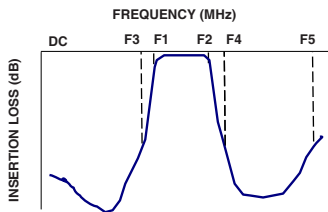

Electrical Specifications at 25°C

Parameter	F#	Frequency (MHz)	Min.	Typ.	Max.	Unit
Pass Band	Center Frequency	-	-	1500	-	MHz
	Insertion Loss	F1-F2	1350-1650	0.6	2.0	dB
	VSWR	F1-F2	1350-1650	1.2	2.3	:1
Stop Band, Lower	Insertion Loss	DC-F3	DC-75	20.0	30.0	dB
	VSWR	DC-F3	DC-75	20.0	-	:1
Stop Band, Upper	Insertion Loss	F4-F5	2160-3700	20.0	29.0	dB
	VSWR	F4-F5	2160-3700	-	20.0	:1

Maximum Ratings

Operating Temperature	-40°C to 85°C
Storage Temperature	-55°C to 100°C
RF Power Input	4 W max.

Permanent damage may occur if any of these limits are exceeded.

Typical Performance Data at 25°C

Frequency (MHz)	Insertion Loss (dB)	VSWR (:1)	Frequency (MHz)	Group Delay (nsec)
1	68.25	1737.18	1350	1.34
20	42.08	1737.18	1360	1.33
75	30.62	1737.18	1380	1.32
150	24.62	579.06	1400	1.31
240	20.60	248.17	1420	1.33
400	16.25	96.51	1440	1.34
800	9.06	22.00	1450	1.34
1060	3.32	5.31	1460	1.35
1140	1.65	2.89	1480	1.38
1200	0.82	1.83	1500	1.41
1350	0.50	1.29	1520	1.44
1500	0.61	1.39	1540	1.47
1650	0.63	1.05	1560	1.51
1790	3.42	3.89	1580	1.57
1900	13.46	21.46	1600	1.62
1970	20.06	34.75	1610	1.65
2110	30.68	49.64	1620	1.68
2160	33.99	52.65	1630	1.71
3250	43.44	49.64	1640	1.75
3700	45.35	49.64	1650	1.79

+RoHS Compliant
The +Suffix identifies RoHS Compliance. See our web site for RoHS Compliance methodologies and qualifications

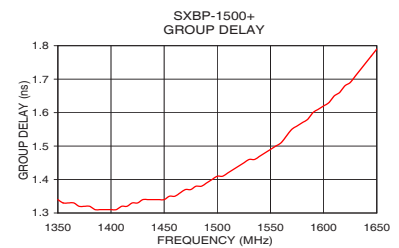
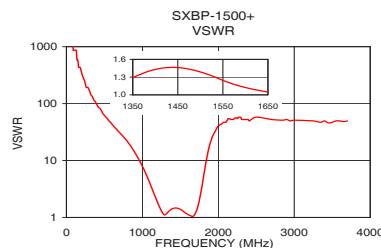
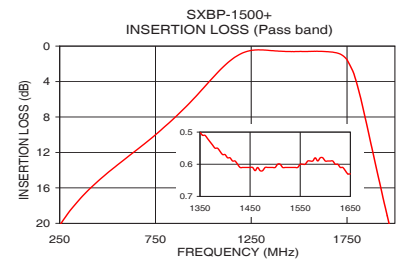
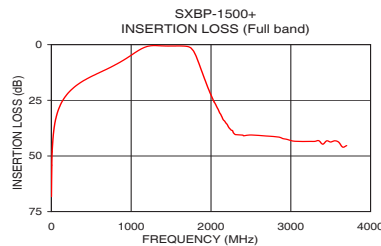

Notes

- Performance and quality attributes and conditions not expressly stated in this specification document are intended to be excluded and do not form a part of this specification document.
- Electrical specifications and performance data contained in this specification document are based on Mini-Circuits' applicable established test performance criteria and measurement instructions.
- The parts covered by this specification document are subject to Mini-Circuits standard limited warranty and terms and conditions (collectively, "Standard Terms"); Purchasers of this part are entitled to the rights and benefits contained therein. For a full statement of the Standard Terms and the exclusive rights and remedies thereunder, please visit Mini-Circuits' website at www.minicircuits.com/MCLStore/terms.jsp



www.minicircuits.com P.O. Box 350166, Brooklyn, NY 11235-0003 (718) 934-4500 sales@minicircuits.com

REV. C
ECO-005139
SXBP-1500+
EDU1704
URJ
201201
Page 2 of 3

Pad Connections

INPUT	1
OUTPUT	8
GROUND	2,3,4,5,6,7

Demo Board MCL P/N: TB-368+ Suggested PCB Layout (PL-230)

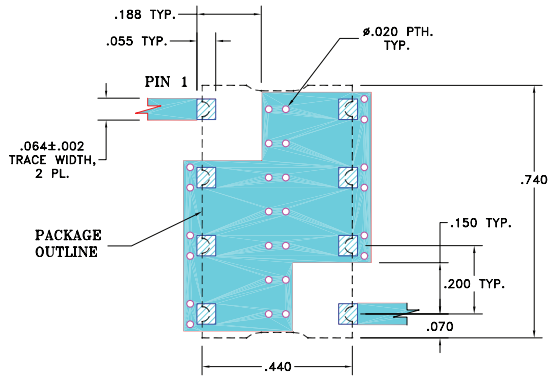

NOTE:

- TRACE WIDTH IS SHOWN FOR FR4 WITH DIELECTRIC THICKNESS: .025" ± .002". COPPER: 1/2 OZ. EACH SIDE. FOR OTHER MATERIALS TRACE WIDTH MAY NEED TO BE MODIFIED.
- BOTTOM SIDE OF THE PCB IS CONTINUOUS GROUND PLANE.

- DENOTES PCB COPPER LAYOUT WITH SMOBC (SOLDER MASK OVER BARE COPPER)
- DENOTES COPPER LAND PATTERN FREE OF SOLDER MASK

Outline Drawing

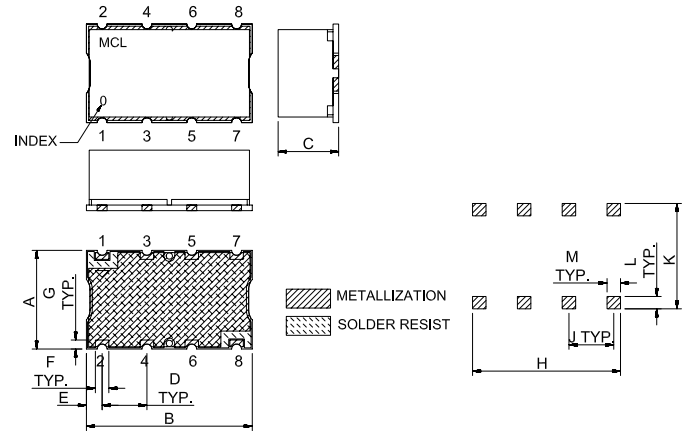

Outline Dimensions (inch/mm)

A	B	C	D	E	F	G
.44	.74	.27	.200	.07	.060	.040
11.18	18.80	6.86	5.08	1.78	1.52	1.02
H	J	K	L	M	wt	
.660	.200	.470	.055	.060	grams	
16.76	5.08	11.94	1.40	1.52	3.0	

Note: Please refer to case style drawing for details

Notes

- Performance and quality attributes and conditions not expressly stated in this specification document are intended to be excluded and do not form a part of this specification document.
- Electrical specifications and performance data contained in this specification document are based on Mini-Circuit's applicable established test performance criteria and measurement instructions.
- The parts covered by this specification document are subject to Mini-Circuit's standard limited warranty and terms and conditions (collectively, "Standard Terms"); Purchasers of this part are entitled to the rights and benefits contained therein. For a full statement of the Standard Terms and the exclusive rights and remedies thereunder, please visit Mini-Circuit's website at www.minicircuits.com/MCLStore/terms.jsp

Typical Performance Data

FREQ. (MHz)	INSERTION LOSS			INPUT RETURN LOSS			OUTPUT RETURN LOSS		
	(dB)			(dB)			(dB)		
	@-40°C	@+25°C	@+85°C	@-40°C	@+25°C	@+85°C	@-40°C	@+25°C	@+85°C
1	68.18	68.25	67.95	0.00	0.00	0.00	0.00	0.00	0.01
30	38.58	38.54	38.52	0.01	0.00	0.01	0.01	0.01	0.01
60	32.62	32.54	32.50	0.01	0.01	0.01	0.01	0.01	0.01
75	30.72	30.62	30.57	0.01	0.01	0.02	0.01	0.02	0.02
100	28.25	28.12	28.05	0.01	0.02	0.02	0.01	0.02	0.02
150	24.75	24.62	24.51	0.02	0.03	0.04	0.02	0.04	0.04
200	22.20	22.15	22.04	0.04	0.05	0.06	0.04	0.06	0.07
240	20.56	20.60	20.52	0.06	0.07	0.08	0.06	0.08	0.09
300	18.57	18.69	18.68	0.09	0.10	0.11	0.10	0.12	0.13
420	15.78	15.84	15.93	0.17	0.20	0.20	0.19	0.21	0.22
500	14.28	14.31	14.40	0.25	0.28	0.29	0.27	0.30	0.30
580	12.90	12.93	12.99	0.34	0.37	0.38	0.37	0.40	0.41
700	10.91	10.90	10.91	0.52	0.56	0.58	0.55	0.59	0.61
740	10.21	10.20	10.19	0.60	0.64	0.66	0.63	0.68	0.70
800	9.06	9.06	9.03	0.75	0.79	0.82	0.79	0.83	0.85
840	8.26	8.29	8.24	0.90	0.94	0.97	0.93	0.97	1.00
900	6.99	7.04	6.99	1.22	1.26	1.31	1.23	1.28	1.32
1000	4.72	4.75	4.69	2.13	2.20	2.29	2.13	2.20	2.28
1060	3.31	3.32	3.27	3.19	3.31	3.45	3.19	3.31	3.44
1080	2.86	2.86	2.82	3.69	3.85	4.00	3.70	3.84	3.99
1160	1.31	1.32	1.33	7.10	7.44	7.66	7.05	7.37	7.58
1220	0.60	0.65	0.69	12.34	12.90	13.13	12.10	12.59	12.78
1285	0.35	0.42	0.47	24.50	25.29	25.33	21.54	21.78	21.77
1300	0.35	0.43	0.48	25.53	25.50	25.69	22.08	21.98	22.05
1350	0.42	0.50	0.54	17.99	17.96	18.32	17.28	17.28	17.62
1390	0.48	0.56	0.60	15.20	15.39	15.72	14.88	15.09	15.44
1400	0.49	0.57	0.61	14.81	15.05	15.39	14.55	14.80	15.15
1500	0.54	0.61	0.66	14.99	15.80	16.08	14.92	15.77	16.08
1600	0.48	0.59	0.65	23.41	24.66	24.80	23.78	25.31	25.46
1650	0.52	0.63	0.71	31.56	32.37	32.58	31.25	31.11	30.33
1680	0.57	0.70	0.78	29.61	28.07	26.58	27.77	26.16	24.94
1700	0.64	0.79	0.88	22.32	21.02	20.08	21.65	20.37	19.53
1735	0.98	1.19	1.33	13.09	12.34	11.89	12.99	12.26	11.83
1750	1.29	1.54	1.71	10.16	9.60	9.26	10.13	9.59	9.26
1790	3.05	3.42	3.67	4.76	4.57	4.45	4.78	4.61	4.49
1830	6.27	6.67	6.95	2.14	2.14	2.13	2.16	2.18	2.17
1870	10.16	10.53	10.81	1.07	1.13	1.16	1.12	1.19	1.21
1890	12.14	12.48	12.76	0.82	0.89	0.92	0.87	0.95	0.97
1900	13.13	13.46	13.73	0.74	0.81	0.84	0.77	0.85	0.88
1970	19.80	20.06	20.30	0.42	0.50	0.54	0.45	0.53	0.56
2000	22.37	22.61	22.85	0.35	0.43	0.47	0.39	0.46	0.50
2020	23.96	24.20	24.43	0.34	0.41	0.45	0.35	0.43	0.47
2100	29.82	29.92	30.04	0.28	0.37	0.41	0.29	0.37	0.42
2110	30.49	30.68	30.96	0.27	0.35	0.40	0.28	0.36	0.40
2160	33.80	33.99	34.33	0.25	0.33	0.38	0.26	0.34	0.38
2200	35.58	35.72	35.75	0.24	0.33	0.38	0.23	0.32	0.36
2300	40.18	40.27	40.31	0.22	0.31	0.37	0.22	0.31	0.36
2320	40.98	40.79	40.75	0.24	0.33	0.39	0.22	0.31	0.36
2400	40.49	40.65	40.28	0.25	0.34	0.41	0.21	0.31	0.37
2480	40.04	39.65	40.02	0.21	0.31	0.38	0.22	0.33	0.39
2500	40.58	40.59	40.77	0.21	0.30	0.37	0.23	0.33	0.39
2600	39.80	41.17	42.38	0.25	0.35	0.42	0.23	0.33	0.39
2700	40.74	41.05	41.12	0.22	0.33	0.40	0.22	0.32	0.40
2800	41.37	41.99	41.80	0.24	0.35	0.42	0.23	0.33	0.40
2950	42.20	42.51	42.95	0.25	0.35	0.42	0.21	0.33	0.40
3200	40.91	40.82	41.11	0.27	0.37	0.42	0.26	0.37	0.43
3350	43.25	43.12	43.45	0.27	0.37	0.41	0.26	0.37	0.41
3500	43.26	43.72	44.35	0.28	0.37	0.42	0.32	0.42	0.45
3600	43.67	43.81	43.61	0.26	0.35	0.39	0.28	0.38	0.43
3700	44.73	45.35	46.63	0.26	0.35	0.40	0.29	0.40	0.45

Typical Performance Data

FREQ. (MHz)	GROUP DELAY		
	(nsec)		
	@-40°C	@+25°C	@+85°C
1350	1.35	1.34	1.33
1355	1.35	1.33	1.33
1360	1.34	1.33	1.33
1365	1.34	1.33	1.32
1370	1.34	1.32	1.32
1375	1.34	1.32	1.32
1380	1.33	1.32	1.32
1385	1.33	1.31	1.31
1395	1.32	1.31	1.31
1400	1.32	1.31	1.31
1405	1.32	1.31	1.31
1410	1.33	1.32	1.32
1415	1.33	1.32	1.32
1420	1.34	1.33	1.33
1425	1.34	1.33	1.33
1430	1.34	1.34	1.34
1435	1.35	1.34	1.34
1440	1.35	1.34	1.34
1445	1.35	1.34	1.34
1450	1.35	1.34	1.35
1455	1.36	1.35	1.35
1460	1.36	1.35	1.36
1465	1.36	1.36	1.36
1470	1.37	1.37	1.37
1475	1.38	1.37	1.37
1480	1.38	1.38	1.38
1485	1.39	1.38	1.38
1490	1.39	1.39	1.39
1495	1.40	1.40	1.40
1500	1.41	1.41	1.41
1505	1.42	1.41	1.41
1510	1.43	1.42	1.42
1515	1.44	1.43	1.43
1520	1.45	1.44	1.44
1525	1.46	1.45	1.45
1530	1.46	1.46	1.46
1535	1.46	1.46	1.46
1540	1.47	1.47	1.47
1545	1.48	1.48	1.48
1550	1.49	1.49	1.49
1555	1.50	1.50	1.50
1560	1.52	1.51	1.51
1565	1.54	1.53	1.53
1570	1.55	1.55	1.55
1575	1.57	1.56	1.56
1580	1.58	1.57	1.57
1585	1.59	1.58	1.59
1590	1.60	1.60	1.60
1595	1.61	1.61	1.61
1600	1.63	1.62	1.62
1605	1.64	1.63	1.63
1610	1.65	1.65	1.65
1615	1.67	1.66	1.67
1620	1.68	1.68	1.68
1625	1.70	1.69	1.70
1630	1.71	1.71	1.71
1635	1.73	1.73	1.73
1640	1.75	1.75	1.75
1645	1.77	1.77	1.77
1650	1.79	1.79	1.79

Typical Performance Curves

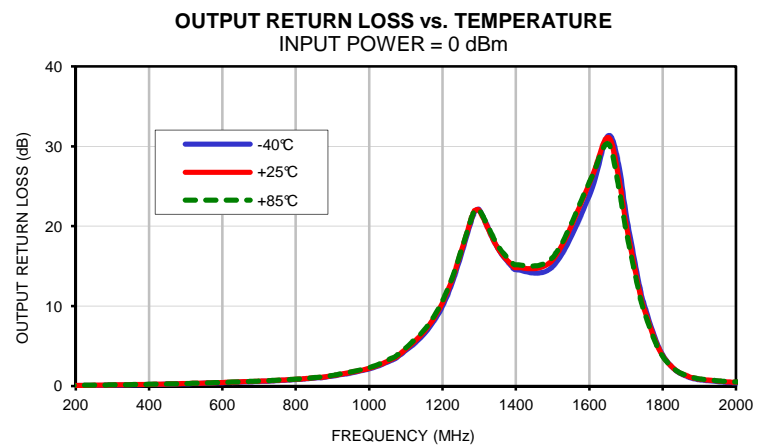
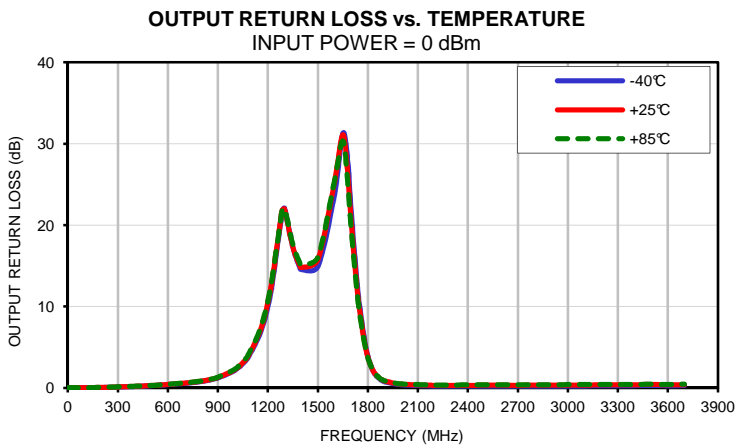
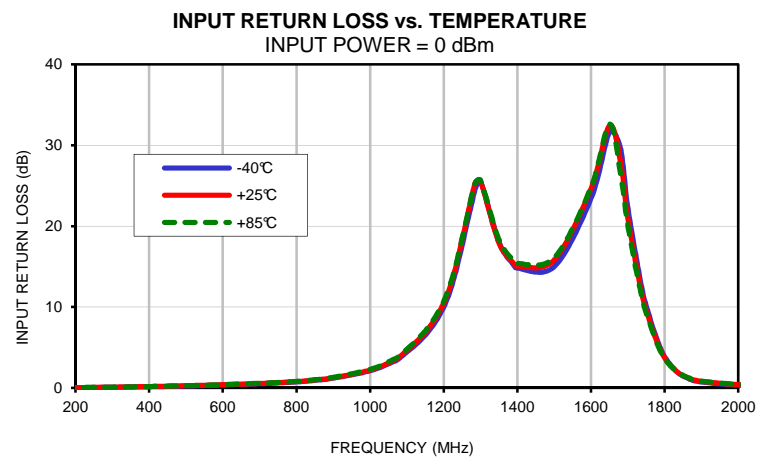
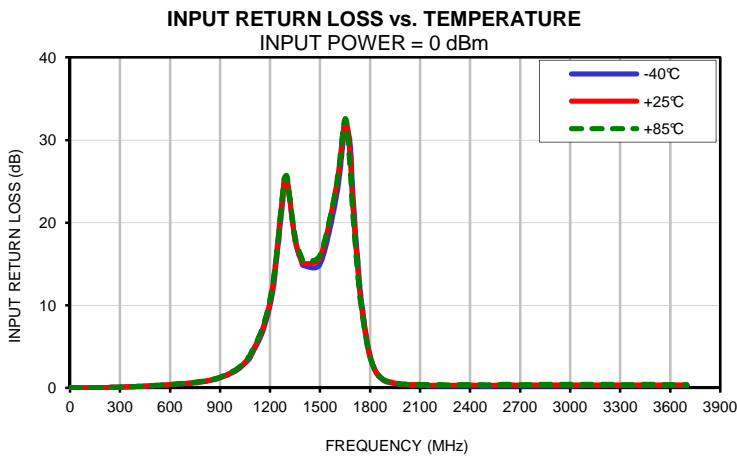
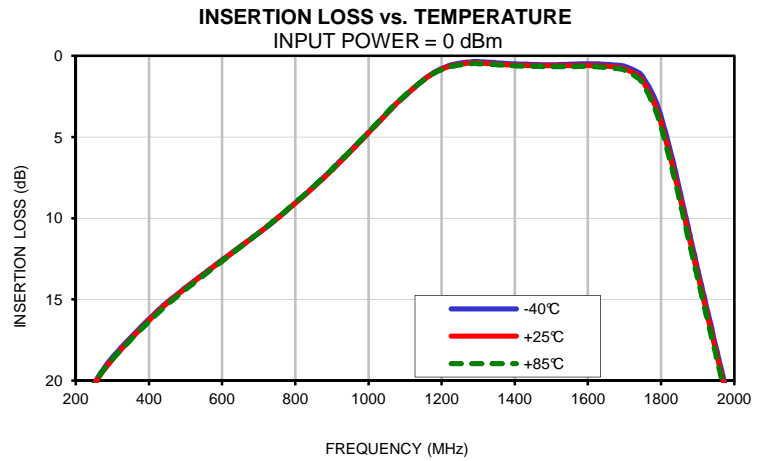
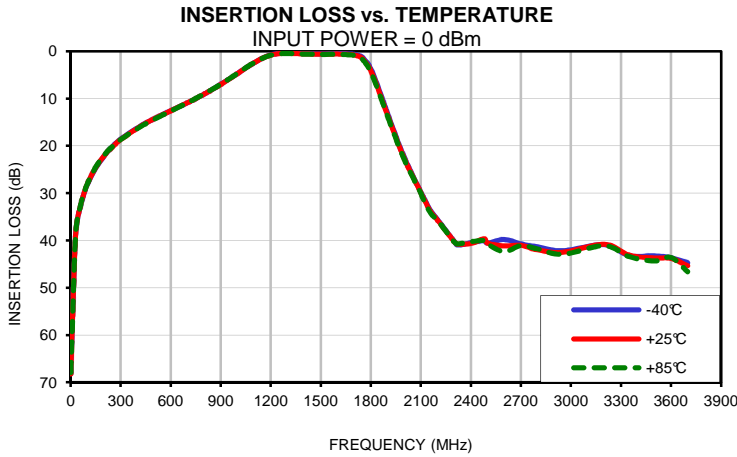

Band Pass Filter

SXBP-1500+

Typical Performance Curves

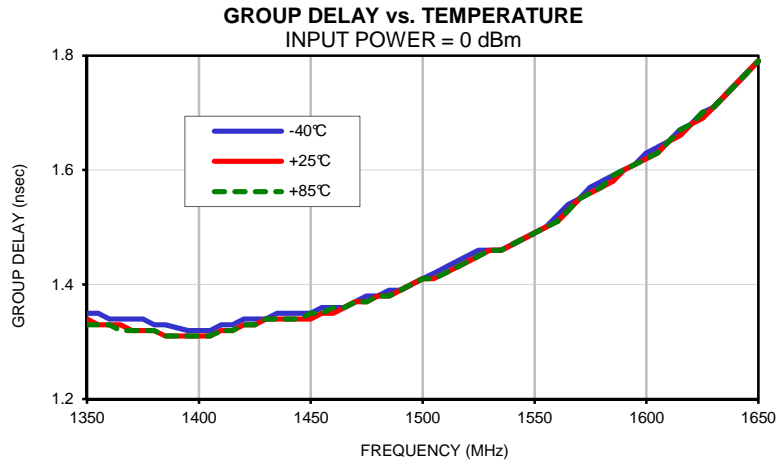

Outline Dimensions

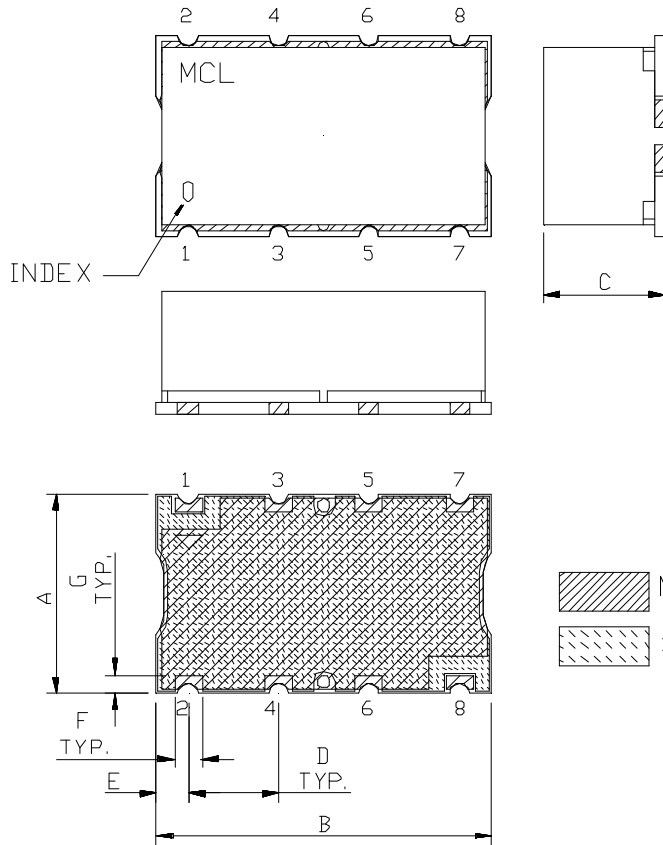

PCB Land Pattern

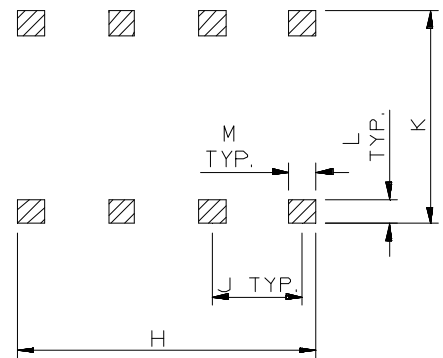

 METALLIZATION
 SOLDER RESIST

CASE #	A	B	C	D	E	F	G	H	J	K	L	M	WT. GRAMS
HF1139	.44 (11.18)	.74 (18.80)	.27 (6.86)	.200 (5.08)	.07 (1.78)	.060 (1.52)	.040 (1.02)	.660 (16.76)	.200 (5.08)	.470 (11.94)	.055 (1.40)	.060 (1.52)	3.0

Dimensions are in inches (mm). Tolerances: 2 Pl. $\pm 0.015''$; 3 Pl. $\pm 0.01''$

Notes:

- Case material: Nickel-Silver alloy.
- Base: Printed wiring laminate.
- Termination finish:
 - For RoHS Case Styles: 2-5 μ inch (.05-.13 microns) Gold over 120-240 μ inch (3.05-6.10 microns) Nickel plate.
 - For RoHS-5 Case Styles: Tin-Lead plate.



P.O. Box 350166, Brooklyn, New York 11235-0003 (718) 934-4500 Fax (718) 332-4661 For detailed performance specs & shopping online see Mini-Circuits web site



The Design Engineers Search Engine Provides ACTUAL Data Instantly From MINI-CIRCUITS At: www.minicircuits.com

RF/IF MICROWAVE COMPONENTS

Tape & Reel Packaging TR-F5

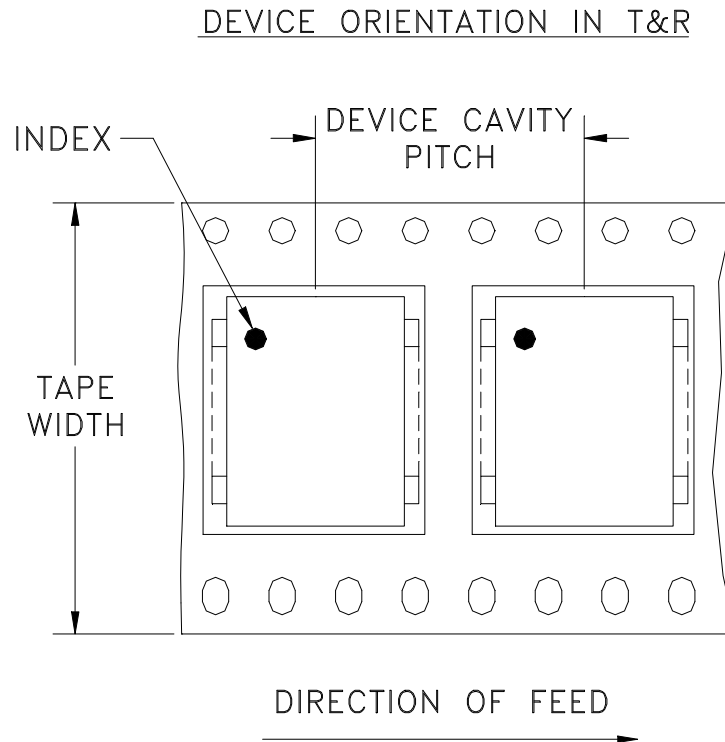

Tape Width, mm	Device Cavity Pitch, mm	Reel Size, inches	Devices per Reel
32	16	13	500

Mini-Circuits carrier tape materials provide protection from ESD (Electro-Static Discharge) during handling and transportation. Tapes are static dissipative and comply with industry standards EIA-481/EIA-541.

Go to: www.minicircuits.com/pages/pdfs/tape.pdf



Distribution Centers NORTH AMERICA 800-654-7949 • 417-335-5935 • Fax 417-335-5945 • EUROPE 44-1252-832600 • Fax 44-1252-837010

Mini-Circuits ISO 9001 & ISO 14001 Certified

INTERNET <http://www.minicircuits.com>

P.O. Box 350166, Brooklyn, New York 11235-0003 (718) 934-4500 Fax (718) 332-4661

THIRD ANGLE PROJECTION

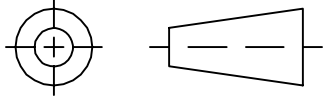

REVISIONS

REV	ECN No.	DESCRIPTION	DATE	DR	AUTH
OR	M101757	NEW RELEASE (FROM RAVON)	11/05	DK	HH
OR	R62293	NEW RELEASE (FROM RAVON)	11/05	DK	HH

**SUGGESTED MOUNTING CONFIGURATION
FOR HF1139 CASE STYLE, cr PIN CONNECTION, 50 OHM.**

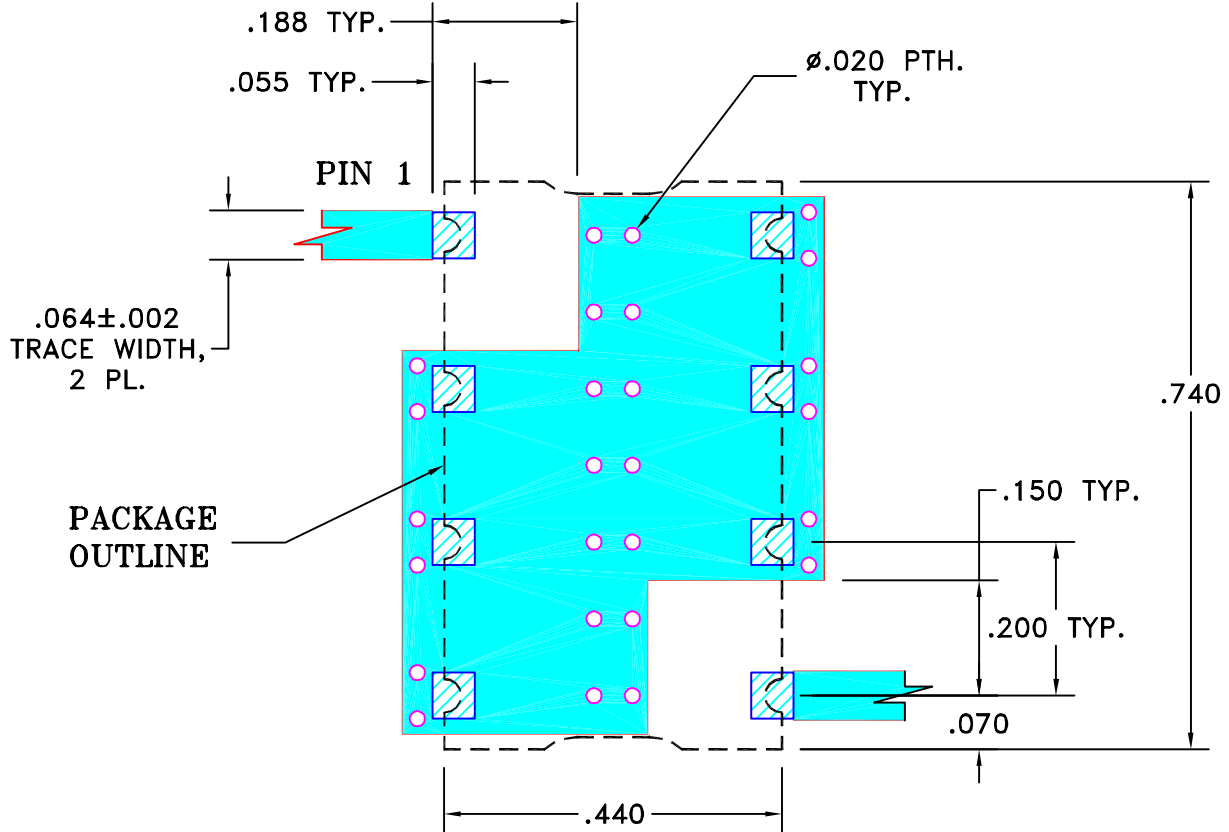

NOTE:

- TRACE WIDTH IS SHOWN FOR FR4 WITH DIELECTRIC THICKNESS: .025"±.002". COPPER: 1/2 OZ. EACH SIDE. FOR OTHER MATERIALS TRACE WIDTH MAY NEED TO BE MODIFIED.
- BOTTOM SIDE OF THE PCB IS CONTINUOUS GROUND PLANE.



DENOTES PCB COPPER LAYOUT WITH SMOBC (SOLDER MASK OVER BARE COPPER)

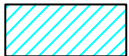

DENOTES COPPER LAND PATTERN FREE OF SOLDER MASK

UNLESS OTHERWISE SPECIFIED	INITIALS		DATE
DIMENSIONS ARE IN INCHES TOLERANCES ON: 2 PL DECIMALS ± 3 PL DECIMALS ± .005 ANGLES ± FRACTIONS ±	DRAWN	DK (RAVON)	29 NOV 05
	CHECKED	RZ (RAVON)	29 NOV 05
	APPROVED	HH (RAVON)	29 NOV 05



Mini-Circuits®

13 Neptune Avenue
Brooklyn NY 11235

PL, cr, HF1139, SCLF, TB-368

Mini-Circuits®
THIS DOCUMENT AND ITS CONTENTS ARE THE PROPERTY OF MINI-CIRCUITS. EXCEPT FOR USE EXPRESSLY GRANTED, IN WRITING, TO ITS VENDORS, VENDEE AND THE UNITED STATES GOVERNMENT, MINI-CIRCUITS RESERVES ALL PROPRIETARY DESIGN, USE, MANUFACTURING AND REPRODUCTION RIGHTS THERETO. THESE CONTENTS SHALL NOT BE USED, DUPLICATED OR DISCLOSED TO ANY OUTSIDE PARTY, IN WHOLE OR IN PART, WITHOUT WRITTEN PERMISSION OF MINI-CIRCUITS.

SIZE A	CODE IDENT 15542	DRAWING NO: 98-PL-230	REV: OR
FILE: 98PL230	SCALE: 4:1	SHEET: 1 OF 1	

Evaluation Board and Circuit

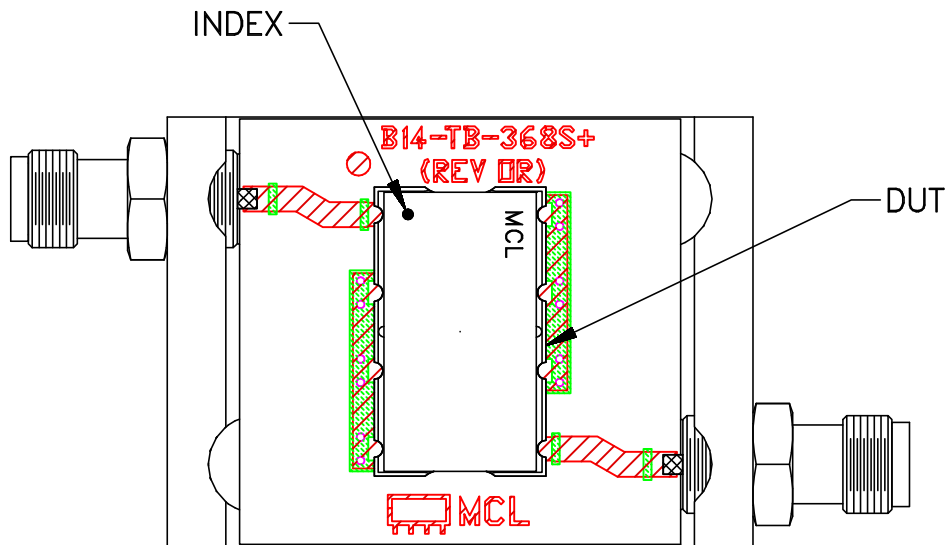

TB-368

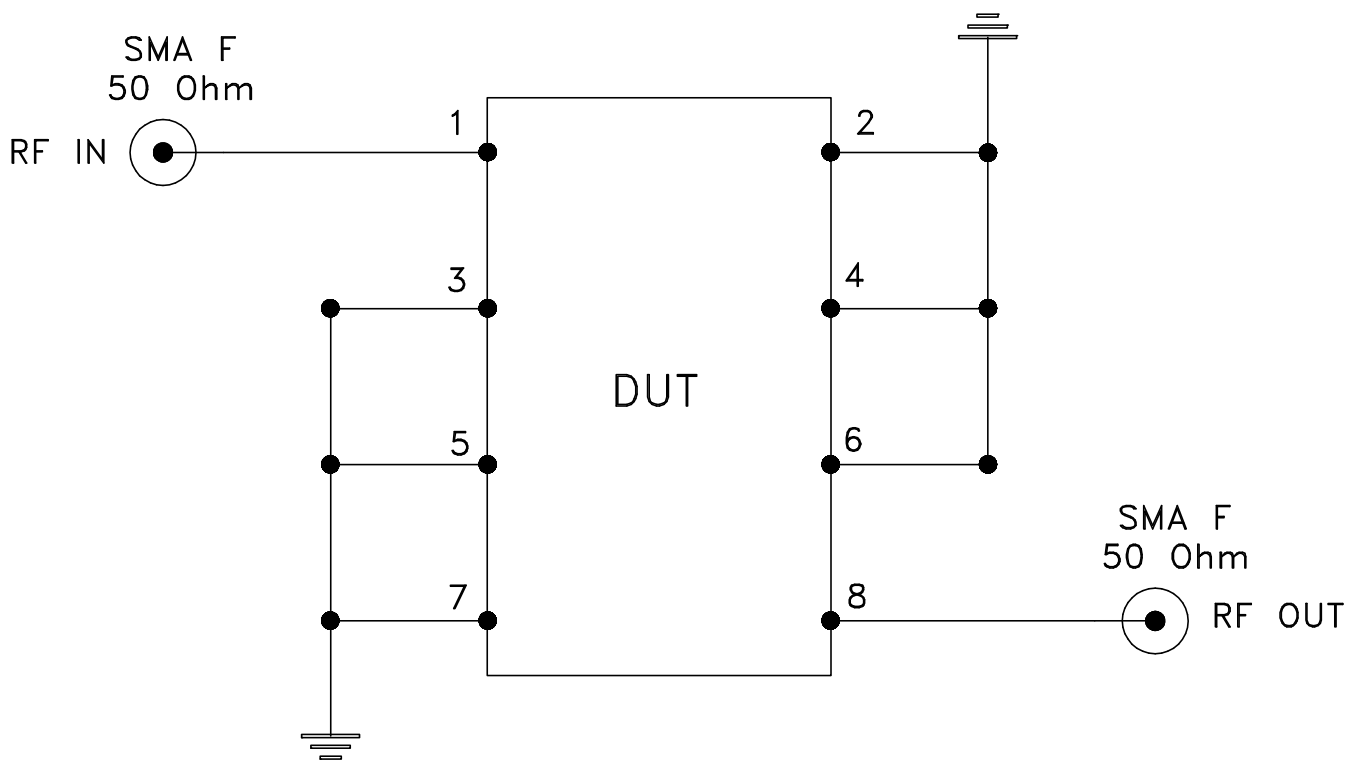

Schematic Diagram

Notes:

1. SMA Female connectors.
2. PCB Material: ROGERS R04350B or equivalent, Dielectric Constant=3.5, Thickness=.030 inch.

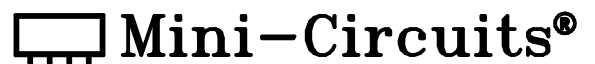

All Mini-Circuits products are manufactured under exacting quality assurance and control standards, and are capable of meeting published specifications after being subjected to any or all of the following physical and environmental test.

Specification	Test/Inspection Condition	Reference/Spec
Operating Temperature	-40° to 85°C Ambient Environment	Individual Model Data Sheet
Storage Temperature	-55° to 100° C Ambient Environment	Individual Model Data Sheet
Humidity	90 to 95% RH, 240 hours, 50°C	MIL-STD-202, Method 103, Condition A, Except 50°C and end-point electrical test done within 12 hours
Thermal Shock	-55° to 100°C, 100 cycles	MIL-STD-202, Method 107, Condition A-3, except +100°C
Solder Reflow Heat	Sn-Pb Eutetic Process: 225°C peak Pb-Free Process 245° - 250°C peak	J-STD-020, Table 4-1, 4-2 and 5-2, Figure 5-1
Solderability	10X Magnification	J-STD-002, 95% Coverage
Vibration (High Frequency)	20g peak, 10-2000 Hz, 12 times in each of three perpendicular directions (total 36)	MIL-STD-202, Method 204, Condition D
Mechanical Shock	50g, 11 ms, 1/2-sine, 18 shocks: 3 each direction, each of 3 axes	MIL-STD-202, Method 213, Condition A
Marking Resistance to Solvents	Isopropyl alcohol + mineral spirits at 25°C; terpene defluxer at 25°C; distilled water + proylene glycol monomethyl ether + monoethanolamine at 63°C to 70°C	MIL-STD-202, Method 215