



## USB & ETHERNET & DAISY-CHAIN

# Wideband Signal Generator **SSG-44GHP-RC**

50Ω 0.1 to 44 GHz -40 dBm to +23 dBm 2.92 mm female

### THE BIG DEAL

- Cost effective millimeter wave signal source
- High output power up to +23 dBm
- Low phase noise across the full band
- Excellent harmonic rejection, -30 dBc typ
- CW & pulsed outputs with 0.5 us pulse width
- Compact package with automation via USB & Ethernet
- SSH secure Ethernet communication

### APPLICATIONS

- 5G FR1 & FR2, WiFi 6E, millimeter wave radio infrastructure
- Semiconductor high power burn-in & life testing
- Wideband LO source
- Benchtop signal generator
- Automated production test systems



Generic photo used for illustration purposes only

### PRODUCT OVERVIEW

Mini-Circuits' SSG-44GHP-RC is a wide-band signal generator operating from 100 MHz to 44 GHz. With up to +17 dBm typical output power at 40 GHz, it is an ideal signal source for characterization of millimeter wave components and systems at high power. Configure CW / single-tone outputs, flexible pulse sequences with pulse widths down to 0.5 μs, or automated frequency / power sweep & hop sequences.

SSG-44GHP-RC has been developed in a compact package with powerful software control and automation to provide a cost effective millimeter wave signal generator and LO source for any bench or production test application. This is a high quality, repeatable and reliable signal source with low phase noise all the way up to 44 GHz (-105 dBc typ @ 100 kHz offset) and excellent harmonic rejection (-30 dBc typ).

The generator can be controlled via USB or Ethernet (supporting SSH, HTTP & Telnet protocols). Full software support is provided, including our user-friendly GUI application for Windows, flexible API and programming instructions for Windows and Linux environments. The daisy-chain control interface with "dynamic addressing" simplifies control integration and allows multiple units to be combined into a multi-channel signal source with control through a single software interface.

### KEY FEATURES

Feature	Advantages
High quality signal source	Outstanding combination of exceptional bandwidth, fine frequency and power resolution, low phase noise and excellent harmonic rejection in a compact package; suited to a wide range of test applications.
Flexible pulse modulation	Configure pulse sequences with varying frequency, power and pulse repetition intervals (PRI).
Sweep & hop sequences	Configure custom CW output frequency and power sequences to run unaided for high speed, automated test applications.
USB & Ethernet control	USB HID and Ethernet (HTTP / Telnet / SSH) interfaces provide easy compatibility with a wide range of software setups and programming environments.
Dynamic daisy-chain control	Simplify control software and interconnections and develop low-cost, multi-channel signal generator systems by daisy-chaining multiple units with control through a single interface.

#### Trademarks:

Windows is a registered trademark of Microsoft Corporation in the United States and other countries ; Linux is a registered trademark of Linus Torvalds ; Pentium is a registered trademark of Intel Corporation. Neither Mini-Circuits nor the Mini-Circuits products are affiliated with or endorsed by the owners of the referenced trademarks. Mini-Circuits and the Mini-Circuits logo are registered trademarks of Scientific Components Corporation.





## ELECTRICAL SPECIFICATIONS AT +25°C

Parameter	Condition (GHz)		Min.	Typ.	Max.	Unit
Output frequency	-		0.1		44	GHz
Frequency resolution <sup>1</sup>	0.1 - 44		-	1	-	Hz
Frequency accuracy	Using internal reference		-	±1	-	ppm
Return Loss	0.1 - 44		-	12	-	dB
Output power Max <sup>2</sup>	0.1 - 22		+20	+23	-	dBm
	22 - 35		+15	+20	-	
	35 - 44		+14	+17	-	
Output power Min	0.1 - 44		-	-40	-35	dBm
Power resolution (nominal)	0.1 - 44		-	0.5	-	dB
Output power accuracy	0.1 - 44	-35 to +15 dBm	-	±1.0	-	dB
RF output level	0.1 - 44	RF off	-	-80	-	dBm
Harmonics	0.1 - 44	-35 to +15 dBm	-	-15	-	dBc
Sub-Harmonics	11 - 22	-35 to +10 dBm	-	-45	-30	dBc
	22 - 44		-	-45	-30	
Non-Harmonic spurious	0.1 - 22	-35 to +10 dBm	-	-50	-	dBc
	22 - 44		-	-40	-	
Settling time <sup>3,4</sup>	Hop mode <sup>4</sup>	0.1 - 31	-	0.45	0.6	ms
		31 - 44	-	0.65	0.8	
	Frequency sweep <sup>5</sup>	0.1 - 31	-	0.35	0.6	
		31 - 44	-	0.65	0.8	
	PC (external) control		-	2	-	
Power transition(at set frequency)		-	0.004	-		
Dwell time (nominal) <sup>4,6</sup>	-		0.01	-	10,000	ms

1. Frequency resolution is tested with 10 MHz external reference.

2. Max power at 43.5-44 GHz will be below 15 dBm.

3. Settling time - transition time between 2 output states. During the transition, RF output is turned off to avoid transient outputs.

4. Generator response time is Dwell time + Settling time.

5. For hop sequences pre-loaded into internal memory (high-speed mode).

6. Dwell time - duration of each signal point in a Sweep or Hop sequence set by user. Default is minimum dwell time.



## REGULAR PULSE MODULATION SPECIFICATIONS AT +25°C

Repetitive RF pulse sequences with fixed frequency and power, supporting internal or external modulation and input / output trigger options.

Parameter	Condition	Min.	Typ.	Max.	Unit
Pulse width resolution	Nominal value	0.05	-	-	μs
Pulse width <sup>6,7</sup>	Measured at the 50% of pulse level	0.5	-	10e6	μs
Pulse period <sup>6</sup>	Measured at the 50% of pulse level	2	-	10e6	μs
Rise / Fall time <sup>8</sup>	Measured between 10% and 90% of pulse level	-	50	-	ns
Pulse width accuracy <sup>9</sup>	Measured at 50% of pulse level				
	Internal pulse modulation	-	±3	-	%
	External pulse modulation	-	±3	-	%
External pulse modulation input threshold	External pulse modulation	-	-	3	V
Trigger response delay	Trigger edge to 50% of pulse level	-	1	-	μs
Pulse power ratio	PWR <sub>OUT</sub> = +10 dBm, FREQ <sub>OUT</sub> = 0.1 GHz	-	70	-	dB
	PWR <sub>OUT</sub> = +10 dBm, FREQ <sub>OUT</sub> = 22 GHz	-	50	-	
	PWR <sub>OUT</sub> = +10 dBm, FREQ <sub>OUT</sub> = 44 GHz	-	50	-	

## DYNAMIC PULSE MODULATION SPECIFICATIONS AT +25°C

Flexible RF pulse sequences with varying frequency, power, pulse width and pulse repetition interval (PRI).

Parameter	Condition	Min.	Typ.	Max.	Unit	
Pulse width resolution	Nominal value	0.05	-	-	μs	
Pulse width <sup>6,7</sup>	Measured at the 50% of pulse level	0.5	-	4e6	μs	
Pulse interval	Fixed freq. & Power	Measured at the 50% of pulse level	4.5	-	4e6	μs
	Varying freq. & Power	Measured at the 50% of pulse level	600	-	4e6	
Duty cycle (in Free Run)	Pulse width divided by Pulse period	0.1	-	99.9	%	
Rise / Fall time <sup>8,10</sup>	Measured between 10% and 90% of pulse level	-	50	-	ns	
Pulse width accuracy <sup>9</sup>	Measured at 50% of pulse level	-	±3	-	%	
Pulse power ratio	PWR <sub>OUT</sub> = +10 dBm, FREQ <sub>OUT</sub> = 0.1 GHz	-	70	-	dB	
	PWR <sub>OUT</sub> = +10dBm, FREQ <sub>OUT</sub> = 44 GHz	-	50	-		

6. Pulse width must be less than pulse period by at least 0.5 μs.

7. Pulse widths below 0.5 μs can be set, however performance is only guaranteed for 0.5 μs and up.

8. Pulse rise time will increase with pulse interval under 3 μs.

9. Pulse width accuracy is 3% of pulse width, or ±100 ns, whichever is greater.

10. For signals at same power & Frequency.



## REFERENCE, TRIGGER & DC POWER AT +25°C

Parameter	Condition		Min.	Typ.	Max.	Unit
Aging	Using internal reference		-	2	-	ppm/yr
Reference in	Frequency	-	-	10	-	MHz
	Power	-	-3.5	-	+7.5	dBm
	Phase noise	10kHz Offset	-	-145	-	dBc/Hz
Reference out	Frequency	-	-	10	-	MHz
	Frequency accuracy	Using internal reference	-	±1	-	ppm
	Power	-	-	±5.5	-	dBm
Trigger out <sup>11</sup>	Low		0	-	0.4	V
	High		3	-	5	
Trigger in	Low		0	-	0.4	V
	High		2.7	-	3.6	
Supply voltage	-		11.4	12	12.6	V <sub>DC</sub>
Supply current <sup>12</sup>	-		-	1250	1900	mA
USB current <sup>12</sup>	-		-	0	-	

11. Trigger out voltage specified with impedance load of 10 kΩ minimum.

12. All power is drawn from power adaptor, USB is used for control only.

## PHASE NOISE (SSB) AT +25°C

Frequency Offset (kHz)	Carrier Frequency (GHz)											
	1		10		20		30		40		44	
	Typ.	Max	Typ.	Max	Typ.	Max	Typ.	Max	Typ.	Max	Typ.	Max
1	-98	-94.5	-77	-73.5	-72	-67.5	-68	-64.5	-65	-61.5	-65	-62.5
10	-118	-116	-102	-97.5	-96	-92.5	-90	-88	-90	-84.5	-90	-86.5
100	-132	-130	-114	-112.5	-108	-106.5	-103	-102	-102	-100.5	-101	-100
1,000	-127	-125.5	-109	-107.5	-102	-100.5	-96	-95.5	-96	-94.5	-100	-97.5
10,000	-138	-135.5	-128	-126.5	-122	-120.5	-116	-114.5	-114	-110.5	-117	-112.5

## ABSOLUTE MAXIMUM RATINGS

Operating temperature	0°C to 50°C
Storage temperature	-20°C to 60°C
Power in @ Reference in	+10 dBm
Reverse power (DC) @ Reference out	8 V <sub>DC</sub>
Reverse power (DC) @ RF out	15 V <sub>DC</sub>
Reverse Power (RF) @ RF out	+24 dBm
Voltage input to trigger ports	-0.3V <sub>DC</sub> to +5.5V <sub>DC</sub>

Permanent damage may occur if any of these limits are exceeded. Operating in the range between operating power limits and absolute maximum ratings for extended periods of time may result in reduced life and reliability.



### TYPICAL PERFORMANCE CURVES\*

Power Accuracy vs. Output Frequency

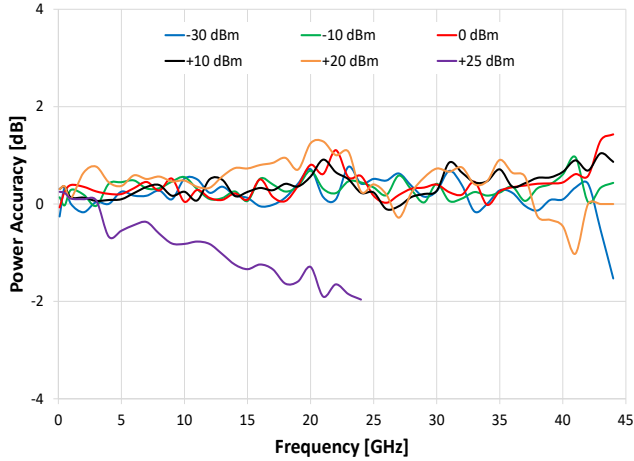

Power Accuracy vs. Output Power

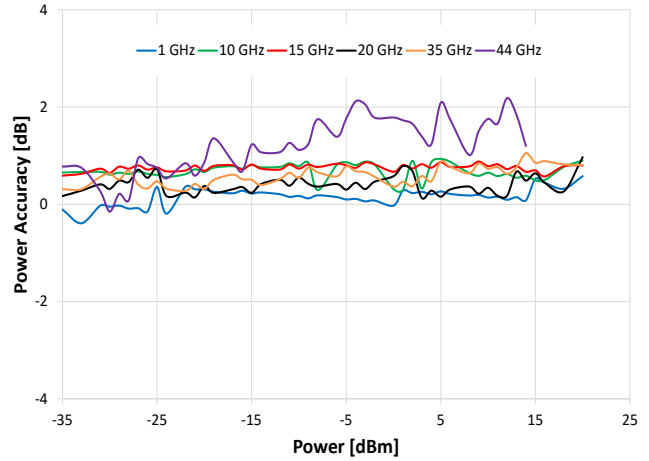

Phase Noise vs. Output Freq. at Frequency Offsets

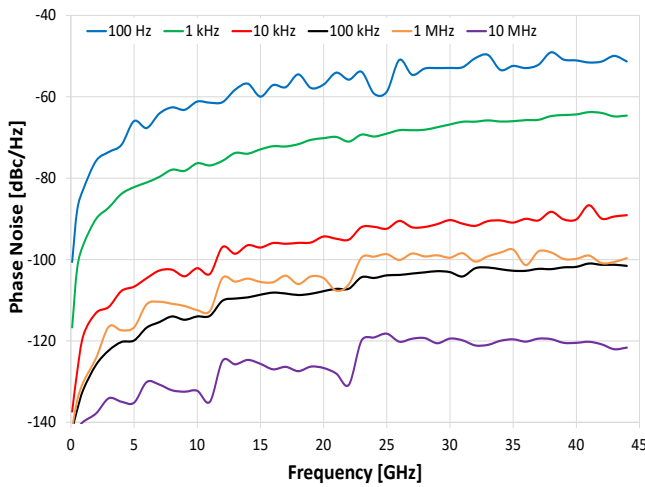

Phase Noise vs. Offset Freq. at Frequency Output

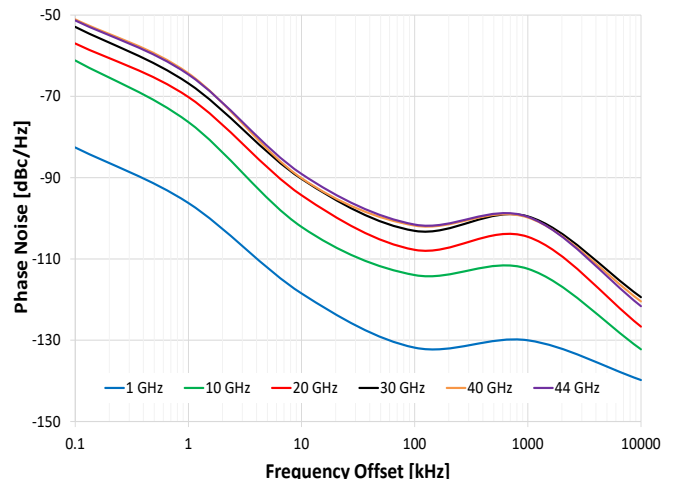

Spurious vs. Output Frequency @ PWR= +5 dBm

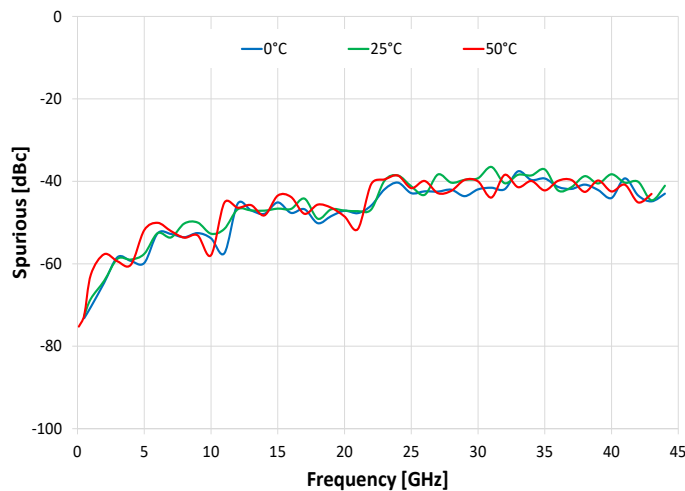



### TYPICAL PERFORMANCE CURVES\* (CONTINUED)

#### Harmonics vs. Output Frequency @ -10 dBm

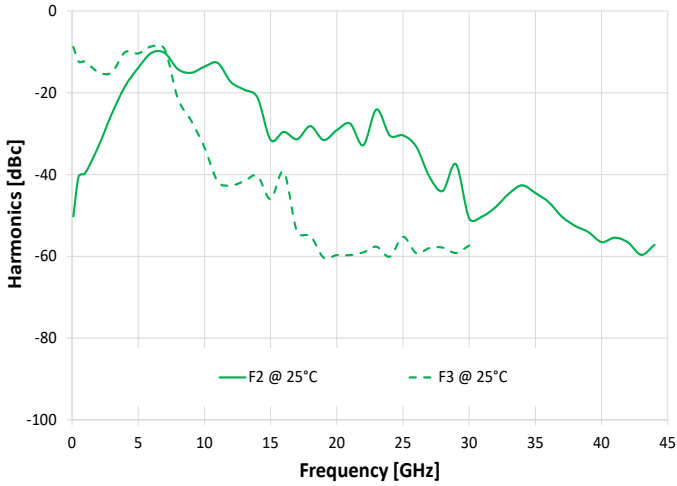

#### Sub-Harmonics vs. Output Frequency @ -10 dBm

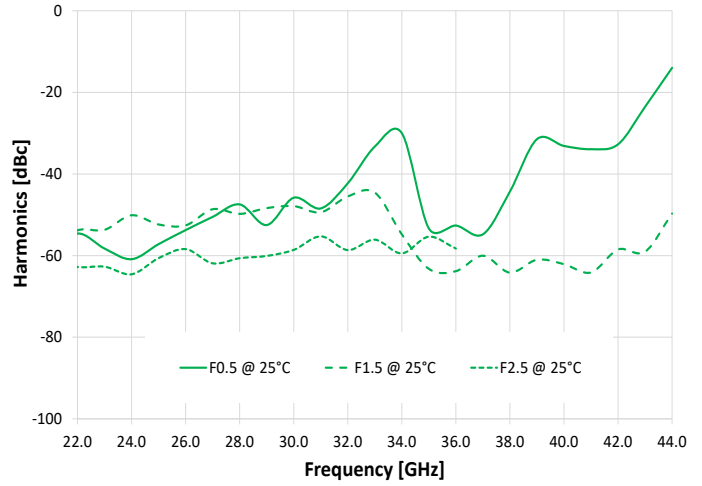

#### Harmonics vs. Output Frequency @ 0 dBm

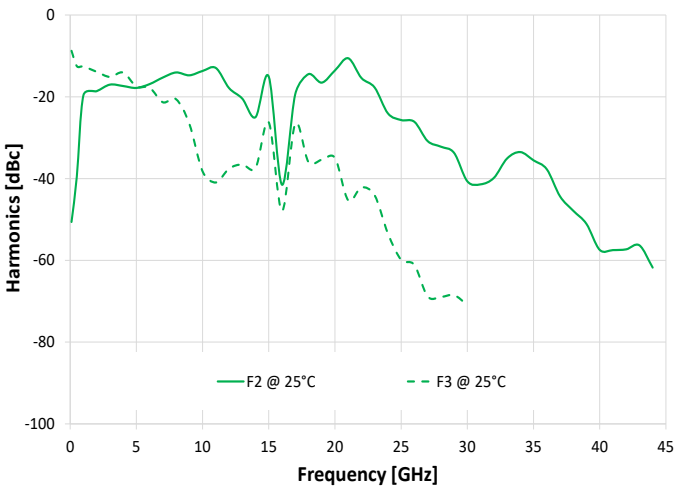

#### Sub-Harmonics vs. Output Frequency @ 0 dBm

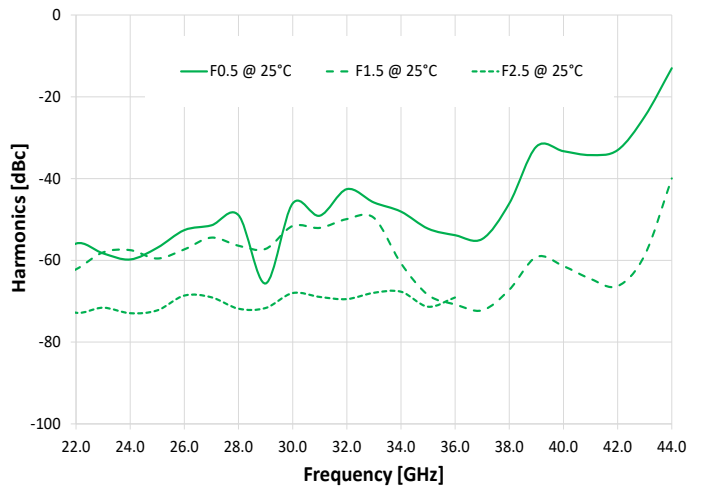

#### Harmonics vs. Output Frequency @ +10 dBm

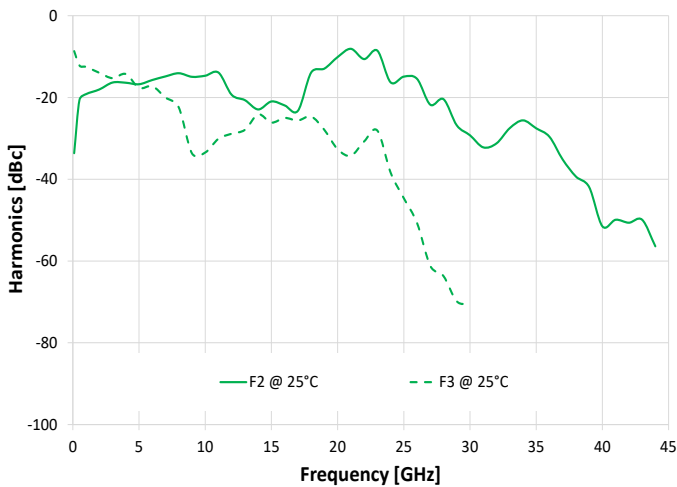

#### Sub-Harmonics vs. Output Frequency @ +10 dBm

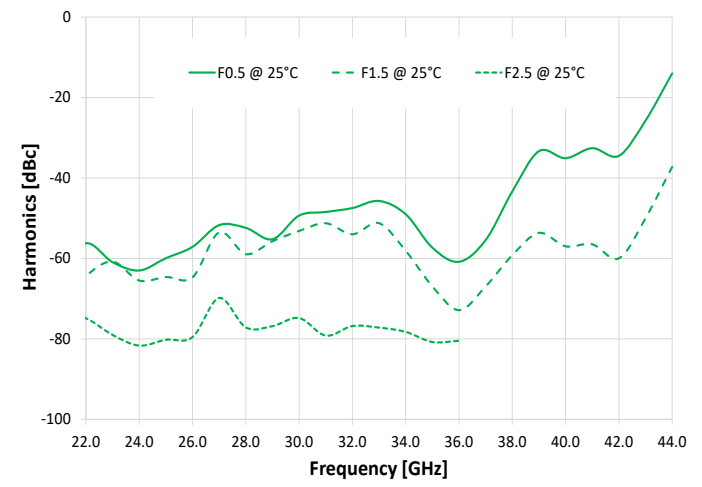



## USB & ETHERNET & DAISY-CHAIN

# Wideband Signal Generator **SSG-44GHP-RC**



50Ω 0.1 to 44 GHz -40 dBm to +23 dBm 2.92 mm female

### CONTROL INTERFACES

Ethernet Control	Supported Protocols	TCP / IP, HTTP, Telnet, SSH, DHCP, UDP (limited)
	Max Data Rate	100 Mbps (100 Base-T Full Duplex)
USB Control	Supported Protocols	HID (Human Interface Device) - High-speed
	Min Communication Time <sup>13</sup>	400 μs typ (full transmit/receive cycle)

13. USB Min Communication Time is based on the polling interval of the USB HID protocol (125 μs polling interval, 64 bytes per packet), medium CPU load and no other high-speed USB devices using the USB bus.

### SOFTWARE & DOCUMENTATION

Mini-Circuits' full software and support package including user guide, Windows GUI, API, programming manual and examples can be downloaded free of charge (refer to the last page for the download path).

A comprehensive set of software control options is provided:

- GUI for Windows – Simple software interface for control via Ethernet and USB.
- Programming / automation via Ethernet:
  - Complete set of control commands which can be sent via any supported protocol.
  - Simple to implement in the majority of modern programming environments.
- Programming / automation via USB:
  - DLL files provide a full API for Windows with a set of intuitive functions which can be implemented in any programming environment supporting .Net Framework or ActiveX.
  - Direct USB programming is possible in any other environment (not supporting .Net or ActiveX).

Please contact [testsolutions@minicircuits.com](mailto:testsolutions@minicircuits.com) for support.

### MINIMUM SYSTEM REQUIREMENTS:

GUI	Windows 7 or later
USB API DLL	Windows 7 or later and programming environment with ActiveX or .NET support
USB Direct Programming	Linux, Windows 7 or later
HTTP, Telnet or SSH	Any computer with a network port and Ethernet-TCP/IP (HTTP, Telnet or SSH protocols) support
Hardware	Intel i3 (or equivalent) or later





## USB & ETHERNET & DAISY-CHAIN

# Wideband Signal Generator **SSG-44GHP-RC**

50Ω 0.1 to 44 GHz -40 dBm to +23 dBm 2.92 mm female

### GRAPHICAL USER INTERFACE (GUI) FOR WINDOWS - KEY FEATURES

- Connect via USB or Ethernet
- Password protected access for safe remote usage over Ethernet

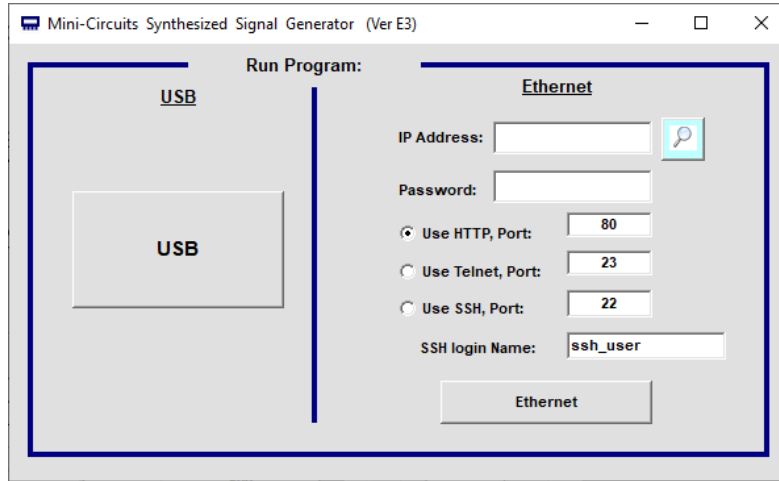

- Configure output power, frequency, pulse modulation
- Program timed signal output sequences (linear sweep and frequency hop)
- Control timed sequences in multiple generators simultaneously
- Track unit operation time since last calibration and setup calibration reminders

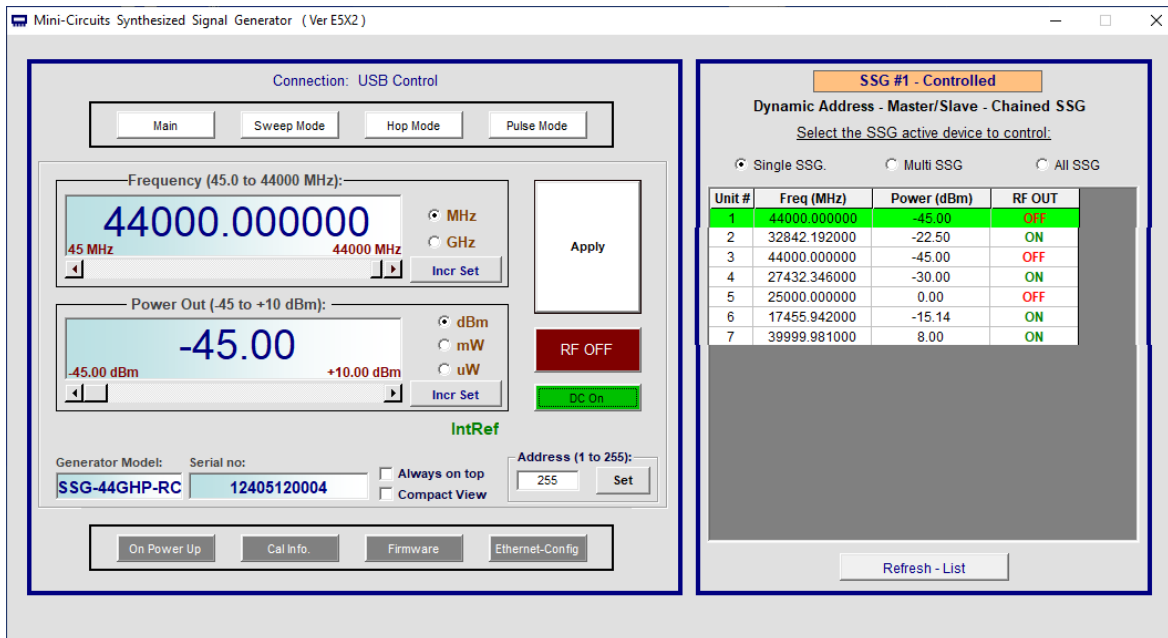





### AUTOMATED SWEEP / HOP SEQUENCES

- Sweep across a frequency band at a fixed output power.
- Sweep output power levels at a fixed frequency.
- Hop through a list of pre-defined frequency / power settings.
- Set dwell times down to 10 μs in high speed mode.
- Run on demand or in response to external triggers.
- Produce triggers to signal switching points or completing a run.

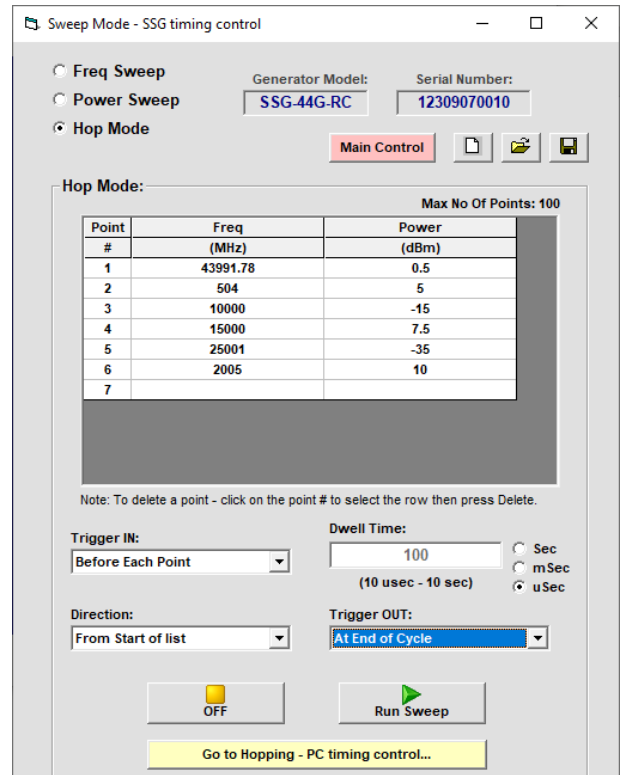

### DYNAMIC PULSE MODULATION

- Configure repetitive pulsed output sequences.
- Define custom pulse lists with a different frequency, power, width & interval at each step.
- Set pulse widths down to 0.5 us.
- Run continuously or for a preset number of cycles.

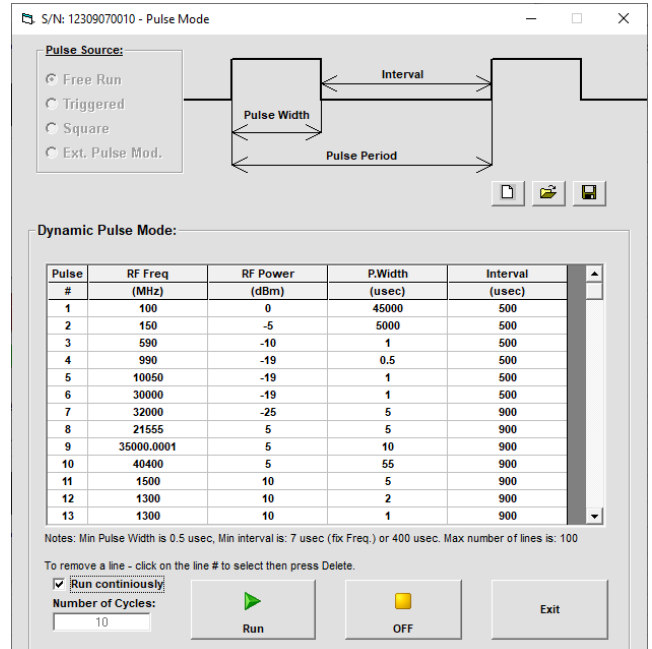



## CONNECTING MULTIPLE MODULES (DAISY CHAIN)

The model is designed to connect up to 25 modules in series (daisy chain) using dynamic addressing, meaning there is no need to specifically set the address of the modules. The addresses will be set automatically as part of establishing the communications with the computer. The module connected to the computer's USB port or Ethernet connection will be assigned address 0 (master), the first module connected to it will get address 1 (slave) and subsequent modules incrementing up to address 24 (slave).

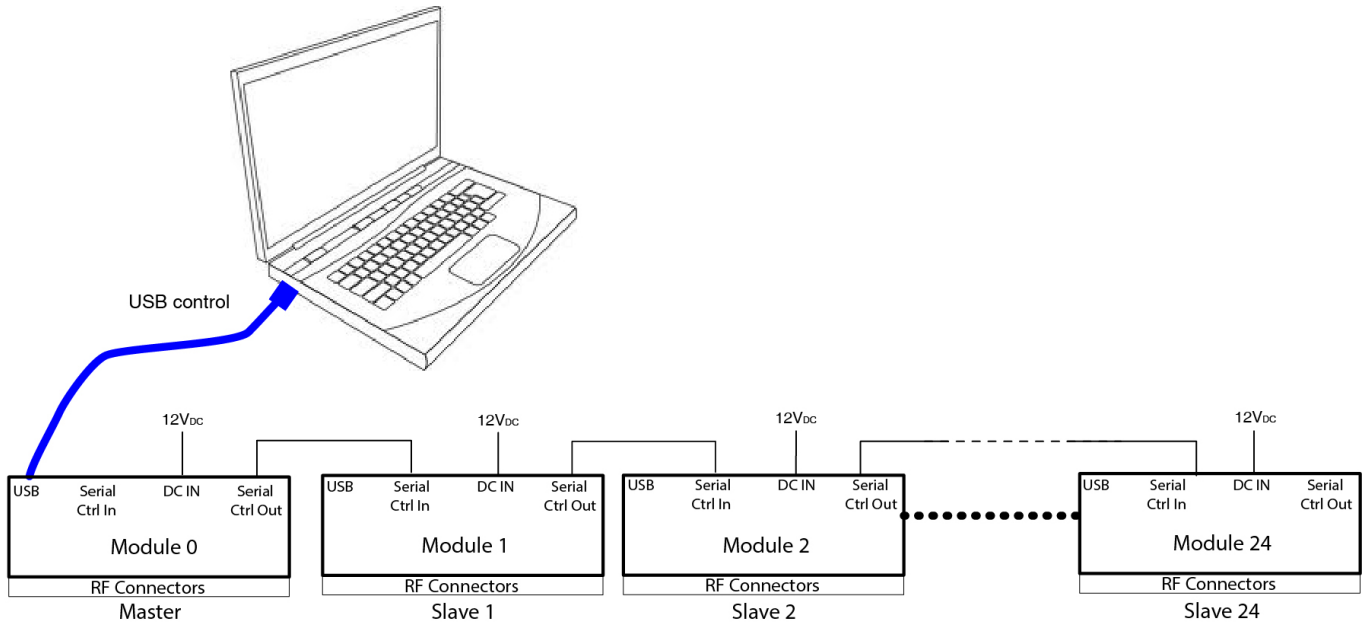

Connections between modules will be made using the serial in/out ports with the module connected to the PC act as a master and all other as slave modules. All control will be through the master module (address 0) which is the only one communicating with the PC or computer network. Serial control out port of each module should be connected to the serial control in port of the next module.

Power for the SSG-44GHP-RC must be supplied to each unit separately via their individual power supplies. The serial master/slave bus allows connecting modules of different types to the same daisy chain as long as all support Mini-Circuits Dynamic addressing setup. To add a new module to the setup, simply connect the module and refresh the address listing, no need to reset any of the existing modules or assign addresses manually.



## BLOCK DIAGRAM

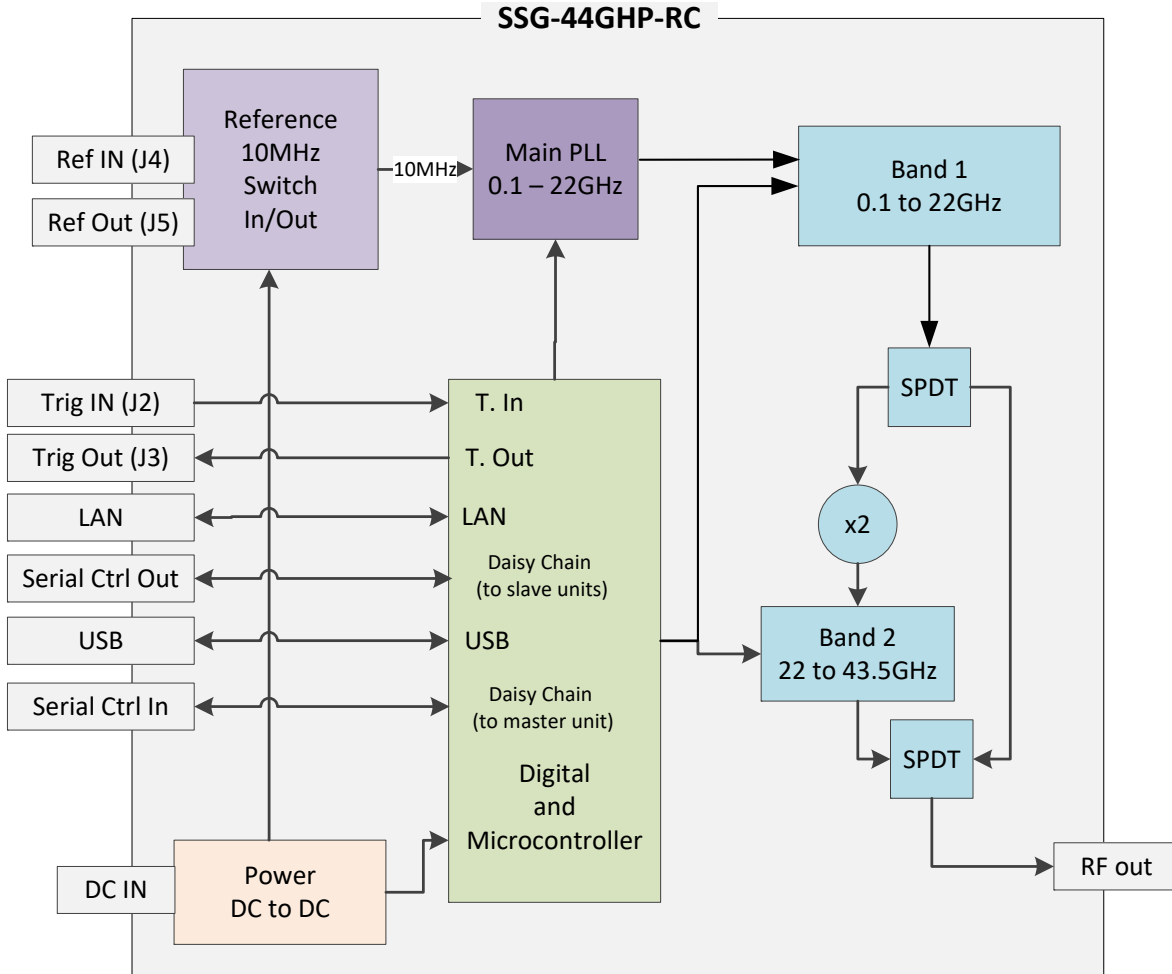

## CONNECTIONS

Port Name	Connector Type
RF output	2.92 mm-Female
Reference in	J4 SMB-Male
Reference out	J5 SMB-Male
Trigger in	J3 SMB-Male
Trigger out	J2 SMB-Male
Power in <sup>14</sup>	2.1 mm DC socket
USB port	USB type C female
Network (Ethernet/LAN)	RJ45 socket
Serial Out (Digital Control 1 port)	Digital Snap Fit Connector <sup>15</sup>
Serial In (Digital Control 2 port)	Digital Snap Fit Connector <sup>15</sup>

<sup>14</sup>. No power On/Off switch - SSG will power on as soon as power is connected, starting at the specified startup condition (factory default set to 44 GHz, -35 dBm, RF Off).

<sup>15</sup>. Mating connector is Hirose ST40X-10S-CV(30)



# USB & ETHERNET & DAISY-CHAIN

# Wideband Signal Generator **Ssg-44GHP-RC**

50Ω 0.1 to 44 GHz -40 dBm to +23 dBm 2.92 mm female

## OUTLINE DRAWING (SL3483)

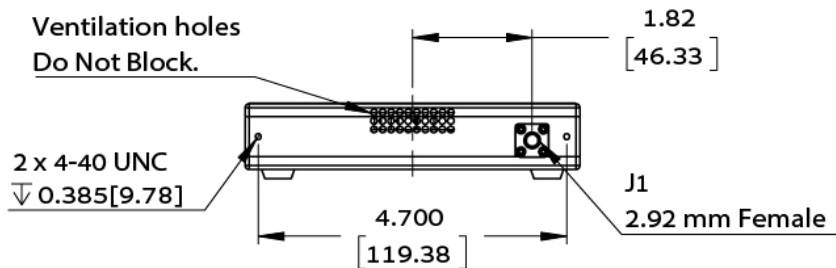
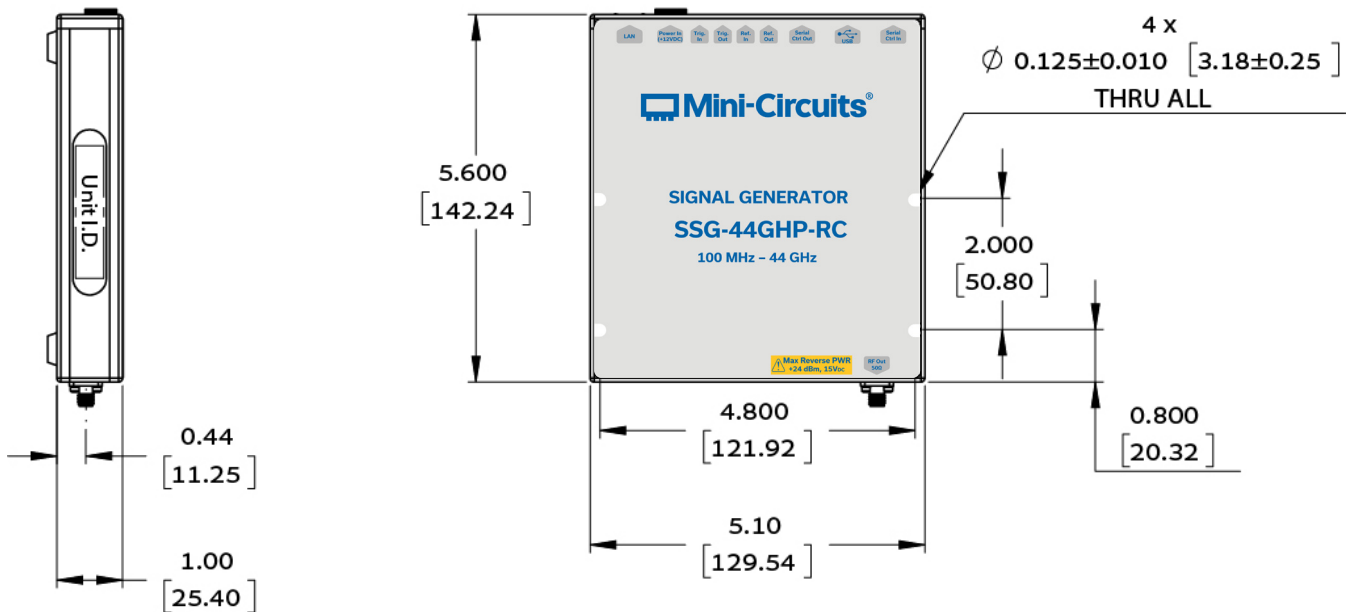
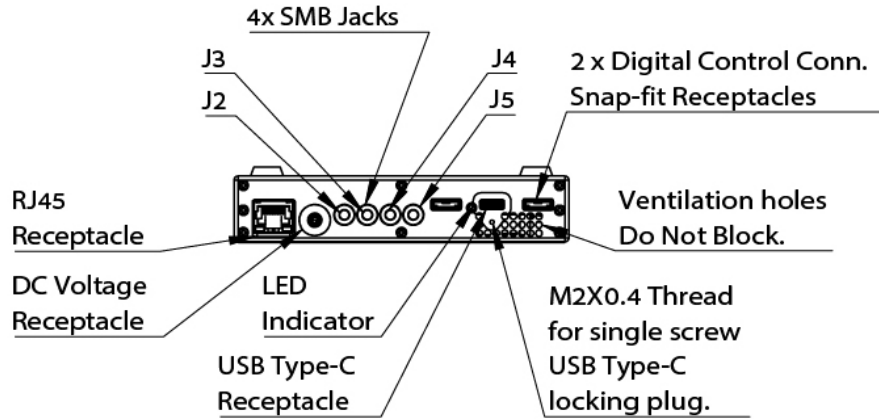



## USB & ETHERNET & DAISY-CHAIN

# Wideband Signal Generator **SSG-44GHP-RC**



Mini-Circuits

50Ω 0.1 to 44 GHz -40 dBm to +23 dBm 2.92 mm female

### DETAILED MODEL INFORMATION IS AVAILABLE ON OUR WEBSITE

Performance Data & Graphs	Data Graphs
Case Style	SL3483
Environmental Rating	ENV55
Software, User Guide & Programming Manual	<a href="https://www.minicircuits.com/softwaredownload/sg.html">https://www.minicircuits.com/softwaredownload/sg.html</a>
Regulatory Compliance	Refer to user guide for compliance information  <a href="https://www.minicircuits.com/app/AN49-003.pdf">https://www.minicircuits.com/app/AN49-003.pdf</a>
Support	<a href="mailto:testsolutions@minicircuits.com">testsolutions@minicircuits.com</a>

### INCLUDED ACCESSORIES

	Qty.	Part No.	Description
	1	AC/DC-12-3W	AC/DC Grounded Power adapter, 0°C to +40°C AC Input: 100-240 V, 50/60 Hz, $I_{Max} = 1.2A$ DC Output $12 \pm 0.6 V$ , $I_{Max} = 3A$
(See images below)	1	CBL-3W-xx	AC Power Cord (Select one power cord from below with each unit)
	1	CBL-0.5FT-MMD+	0.5 ft (0.15 m) Cable assembly for serial control daisy chain with snap fit connectors
	1	USB-CBL-AC-7SC+	6.56 ft. (2 meter) USB cable type A to Type C with single screw lock
	1	CBL-5FT-BMSMB+	5.0 ft (1.5 m) Trigger cable: BNC (male) to SMB (Female)

### AC POWER CORD OPTIONS <sup>16</sup>

United States	Europe	United Kingdom	Australia and China	Israel
				
CBL-3W-US	CBL-3W-EU	CBL-3W-UK	CBL-3W-AU	CBL-3W-IL

16. Select one option from the list with each unit. Please contact [testsolutions@minicircuits.com](mailto:testsolutions@minicircuits.com) if your region is not listed.





## USB & ETHERNET & DAISY-CHAIN

# Wideband Signal Generator **SSG-44GHP-RC**

 Mini-Circuits

50Ω 0.1 to 44 GHz -40 dBm to +23 dBm 2.92 mm female

### OPTIONAL ACCESSORIES

Part No.	Description
USB-CBL-AC-7SC+ (spare)	6.56 ft. (2 meter) USB cable type A to Type C with single screw lock
CBL-RJ45-MM-5+	5.0 ft (1.5 m) network cable: RJ45 (Male) to RJ45 (Male) Cat 5E cable
CBL-5FT-BMSMB+ (spare)	5.0 ft (1.5 m) Trigger & Reference cable: BNC (male) to SMB (Female)
CBL-0.5FT-MMD+ (spare)	0.5 ft (0.15 m) Cable assembly for serial control daisy chain with snap fit connectors
CBL-1.5FT-MMD+	1.5 ft (0.45 m) Cable assembly for serial control daisy chain with snap fit connectors

### CALIBRATION

Part No.	Description
CALSSG-44GHP-RC	Calibration Service for SSG-44GHP-RC <a href="#">CLICK HERE</a>

#### NOTES:

- Performance and quality attributes and conditions not expressly stated in this specification document are intended to be excluded and do not form a part of this specification document.
- Electrical specifications and performance data contained in this specification document are based on Mini-Circuit's applicable established test performance criteria and measurement instructions.
- The parts covered by this specification document are subject to Mini-Circuits standard limited warranty and terms and conditions (collectively, "Standard Terms"); Purchasers of this part are entitled to the rights and benefits contained therein. For a full statement of the Standard Terms and the exclusive rights and remedies thereunder, please visit Mini-Circuits' website at <https://www.minicircuits.com/terms/viewterm.html>



# Signal Generator

**SSG-44GHP-RC**

## Typical Performance Data

Test Conditions: @ Temperature = 25°C.

Freq. (GHz)	Power deviation from nominal vs. Output Frequency (dB)									
	-35 dBm	-30 dBm	-20 dBm	-10 dBm	0 dBm	+5 dBm	+10 dBm	+15 dBm	+20 dBm	+25 dBm
0.10	0.15	-0.26	0.33	0.14	-0.07	0.34	0.31	0.26	0.31	0.25
0.50	-0.11	0.33	0.20	-0.03	0.25	0.36	0.36	0.26	0.36	0.23
1.00	0.01	0.00	-0.08	0.29	0.39	0.24	0.13	0.08	0.12	0.11
2.00	-0.02	-0.17	0.33	0.19	0.35	0.12	0.13	0.02	0.64	0.10
3.00	0.06	0.04	0.03	-0.04	0.26	0.08	0.06	0.13	0.77	0.07
4.00	0.11	0.00	0.47	0.42	0.21	0.08	0.08	-0.04	0.45	-0.67
5.00	0.22	0.25	0.12	0.45	0.21	0.09	0.10	0.51	0.37	-0.55
6.00	0.24	0.17	0.06	0.48	0.33	0.30	0.23	0.16	0.59	-0.43
7.00	0.11	0.17	0.51	0.32	0.45	0.30	0.35	0.14	0.51	-0.37
8.00	0.36	0.28	0.34	0.32	0.28	0.15	0.39	0.20	0.56	-0.61
9.00	0.19	0.10	0.45	0.46	0.52	0.61	0.17	0.45	0.46	-0.81
10.00	0.55	0.52	0.52	0.55	0.05	0.54	0.25	0.09	0.48	-0.82
11.00	0.41	0.51	0.27	0.31	0.29	0.30	0.07	0.51	0.36	-0.77
12.00	0.11	0.23	0.04	0.10	0.12	0.51	0.51	0.48	0.34	-0.82
13.00	0.51	0.36	0.11	0.12	0.09	0.34	0.50	0.37	0.57	-1.03
14.00	0.61	0.18	0.26	0.26	0.22	0.69	0.16	0.56	0.74	-1.24
15.00	0.58	0.13	0.10	0.06	0.09	0.79	0.25	0.64	0.73	-1.34
16.00	0.32	-0.05	0.21	0.52	0.51	0.22	0.33	0.73	0.80	-1.24
17.00	0.16	-0.02	0.40	0.40	0.15	0.28	0.28	0.68	0.84	-1.34
18.00	0.17	0.13	0.32	0.26	0.06	0.32	0.41	0.11	0.95	-1.64
19.00	0.08	0.42	0.84	0.36	0.37	0.48	0.36	0.23	0.71	-1.59
20.00	0.54	0.72	0.58	0.68	0.80	0.36	0.57	0.87	1.25	-1.29
21.00	0.32	0.14	0.29	0.31	0.62	0.55	0.91	0.53	1.29	-1.90
22.00	0.34	0.10	0.22	0.22	1.11	0.72	0.65	0.60	1.00	-1.65
23.00	0.50	0.77	0.36	0.47	0.55	0.11	0.51	0.37	1.07	-1.85
24.00	0.33	0.42	0.44	0.44	0.58	0.32	0.23	0.58	0.25	-1.96
25.00	0.34	0.52	0.10	0.34	0.17	-0.12	0.24	0.26	0.40	--
26.00	0.48	0.48	0.66	0.18	0.03	-0.28	-0.10	0.24	0.20	--
27.00	-0.04	0.63	0.47	0.59	0.19	-0.28	-0.04	-0.34	-0.28	--
28.00	0.39	0.37	0.54	0.29	0.32	-0.12	0.14	0.45	0.23	--
29.00	0.16	0.15	0.19	0.03	0.34	0.11	0.21	0.13	0.54	--
30.00	0.06	0.27	0.39	0.41	0.40	0.14	0.27	0.53	0.73	--
31.00	0.14	0.68	0.54	0.06	0.24	0.26	0.85	0.67	0.66	--
32.00	0.30	0.39	0.25	0.11	0.19	0.38	0.65	0.51	0.75	--
33.00	0.30	-0.16	0.31	0.25	0.46	0.21	0.45	0.31	0.41	--
34.00	-0.02	0.00	0.24	0.17	-0.02	0.41	0.47	0.41	0.47	--
35.00	0.18	0.28	0.12	0.24	0.26	0.86	0.71	0.85	0.91	--
36.00	-0.31	0.23	0.34	0.36	0.34	0.51	0.36	1.16	0.64	--
37.00	0.35	-0.04	0.49	0.06	0.38	0.55	0.43	0.83	0.56	--
38.00	0.35	-0.13	-0.03	0.32	0.42	0.50	0.54	0.77	-0.26	--
39.00	-0.18	0.08	0.44	0.41	0.42	0.58	0.55	0.81	-0.33	--
40.00	-0.14	0.09	0.47	0.61	0.44	1.00	0.66	0.98	-0.46	--
41.00	0.33	0.34	-0.18	0.96	0.61	0.63	0.90	0.69	-1.02	--
42.00	0.19	0.42	0.20	0.04	0.58	0.88	0.69	0.79	--	--
43.00	0.05	-0.54	0.03	0.34	1.31	0.78	1.04	1.21	--	--
44.00	-0.72	-1.53	-0.39	0.44	1.43	0.83	0.87	-0.67	--	--

# Signal Generator

**SSG-44GHP-RC**

## Typical Performance Data

Test Conditions: @ Temperature = 25°C.

Power (dBm)	Power deviation from nominal vs. Output Power (dBm)									
	1 GHz	5 GHz	10 GHz	15 GHz	20 GHz	25 GHz	30 GHz	35 GHz	40 GHz	44 GHz
-35	-0.11	1.85	0.65	0.59	0.17	0.37	1.36	0.31	0.27	0.77
-33	-0.39	1.86	0.66	0.63	0.28	0.38	1.13	0.31	0.76	0.75
-31	-0.03	1.87	0.67	0.73	0.41	0.34	1.49	0.57	0.05	0.27
-30	-0.05	1.93	0.61	0.65	0.32	0.57	1.88	0.63	-0.09	-0.15
-29	-0.03	1.87	0.65	0.77	0.49	0.45	1.68	0.51	-0.22	0.22
-28	-0.09	1.91	0.63	0.73	0.46	0.62	1.57	0.69	0.04	0.08
-27	-0.08	1.86	0.68	0.80	0.71	0.45	1.82	0.41	-0.01	0.95
-26	-0.15	1.90	0.63	0.71	0.55	0.62	1.65	0.33	0.25	0.83
-25	0.36	1.84	0.60	0.76	0.72	0.52	1.76	0.47	0.20	0.75
-24	-0.19	1.88	0.56	0.68	0.17	0.55	1.90	0.32	0.22	0.53
-22	0.36	1.85	0.62	0.69	0.24	0.62	1.43	0.28	0.22	0.84
-21	0.31	1.79	0.72	0.80	0.14	0.70	1.16	0.42	0.29	0.59
-20	0.31	2.31	0.67	0.69	0.38	0.58	1.22	0.32	0.15	0.86
-19	0.26	2.37	0.75	0.79	0.23	0.79	1.45	0.50	0.20	1.36
-17	0.23	2.34	0.78	0.80	0.31	0.10	1.51	0.61	0.16	0.87
-16	0.28	2.29	0.73	0.72	0.35	0.23	1.55	0.51	0.02	0.68
-15	0.22	2.32	0.81	0.82	0.24	0.12	1.36	0.50	0.43	1.22
-14	0.24	2.26	0.76	0.73	0.41	0.34	1.18	0.40	0.31	1.07
-12	0.21	2.24	0.77	0.72	0.50	0.32	1.55	0.52	0.22	1.07
-11	0.15	2.28	0.84	0.82	0.38	0.21	1.41	0.65	0.44	1.26
-10	0.17	2.22	0.79	0.73	0.55	0.44	1.32	0.54	0.35	1.12
-9	0.12	2.24	0.85	0.82	0.42	0.33	1.19	0.75	0.34	1.24
-8	0.18	2.18	0.29	0.77	0.36	0.36	1.34	0.66	0.20	1.75
-6	0.15	2.02	0.81	0.84	0.42	0.47	1.14	0.57	0.16	1.39
-5	0.10	1.97	0.86	0.80	0.30	0.35	1.76	0.78	0.06	1.76
-4	0.11	2.03	0.81	0.75	0.44	0.49	1.65	0.68	0.12	2.12
-3	0.06	1.98	0.88	0.86	0.31	0.39	1.49	0.66	0.65	2.05
-2	0.08	2.02	0.82	0.82	0.46	0.60	1.37	0.57	0.53	1.78
0	-0.03	1.96	0.32	0.67	0.58	0.04	0.85	0.36	0.06	1.79
1	0.28	1.94	0.30	0.81	0.79	-0.06	0.93	0.46	0.11	1.73
2	0.23	2.00	0.89	0.74	0.68	0.13	0.82	0.37	0.59	1.66
3	0.26	1.94	0.32	0.82	0.13	0.00	0.95	0.58	0.64	1.40
4	0.21	2.01	0.87	0.75	0.28	0.25	0.82	0.47	0.55	1.23
5	0.27	1.96	0.93	0.87	0.16	0.14	1.04	0.88	0.65	2.09
6	0.21	1.99	0.87	0.77	0.31	0.33	1.53	0.77	0.57	1.74
8	0.18	1.97	0.64	0.78	0.36	0.43	1.18	0.64	0.46	1.01
9	0.19	1.91	0.59	0.88	0.22	0.32	1.03	0.84	0.85	1.50
10	0.14	1.95	0.65	0.79	0.34	0.53	1.16	0.73	0.31	1.76
11	0.15	1.89	0.58	0.82	0.17	0.39	1.42	0.77	0.69	1.66
12	0.09	1.94	0.62	0.72	0.17	0.35	1.27	0.63	0.51	2.18
13	0.15	1.87	0.55	0.79	0.67	0.19	1.10	0.76	0.62	1.84
14	0.08	1.89	0.59	0.67	0.49	0.72	1.60	1.05	0.81	1.20
15	0.52	2.37	0.49	0.70	0.64	0.54	1.41	0.85	--	--
16	0.44	2.28	0.50	0.57	0.44	0.54	1.20	0.89	--	--
18	0.32	2.13	0.77	0.78	0.26	0.65	1.29	0.82	--	--
20	0.58	2.26	0.90	0.80	0.97	0.93	1.51	0.81	--	--



## Typical Performance Data

Test Conditions: @ Temperature = 25°C.

Freq. (GHz)	Harmonics levels vs. Output Frequency (dBc)									
	-10 dBm					0 dBm				
	F2	F3	F0.5	F1.5	F2.5	F2	F3	F0.5	F1.5	F2.5
0.10	-50.24	-8.80	--	--	--	-50.62	-8.76	--	--	--
0.50	-40.50	-12.35	--	--	--	-39.56	-12.50	--	--	--
1.00	-39.63	-12.45	--	--	--	-19.63	-12.61	--	--	--
2.00	-33.10	-14.97	--	--	--	-18.63	-13.89	--	--	--
3.00	-25.20	-15.04	--	--	--	-17.03	-15.14	--	--	--
4.00	-18.47	-10.09	--	--	--	-17.37	-14.08	--	--	--
5.00	-13.90	-10.39	--	--	--	-17.84	-17.47	--	--	--
6.00	-10.25	-8.67	--	--	--	-16.90	-17.78	--	--	--
7.00	-10.26	-9.37	--	--	--	-15.29	-21.34	--	--	--
8.00	-14.23	-21.44	--	--	--	-14.05	-20.61	--	--	--
9.00	-15.12	-26.83	--	--	--	-14.75	-26.62	--	--	--
10.00	-13.63	-33.35	--	--	--	-13.69	-38.25	--	--	--
11.00	-12.71	-41.70	--	--	--	-12.95	-40.96	--	--	--
12.00	-17.39	-42.68	--	--	--	-17.87	-37.58	--	--	--
13.00	-19.24	-41.65	--	--	--	-20.45	-36.55	--	--	--
14.00	-21.12	-40.32	--	--	--	-24.98	-37.46	--	--	--
15.00	-31.52	-46.03	--	--	--	-15.08	-26.27	--	--	--
16.00	-29.57	-39.39	--	--	--	-41.51	-47.92	--	--	--
17.00	-31.37	-54.04	--	--	--	-19.36	-26.61	--	--	--
18.00	-28.15	-54.94	--	--	--	-14.46	-35.95	--	--	--
19.00	-31.56	-60.31	--	--	--	-16.54	-35.41	--	--	--
20.00	-29.16	-59.71	--	--	--	-13.55	-34.94	--	--	--
21.00	-27.53	-59.71	--	--	--	-10.58	-45.31	--	--	--
22.00	-32.84	-59.03	-54.60	-53.81	-62.79	-15.41	-42.15	-55.90	-62.20	-72.81
23.00	-24.08	-57.65	-58.27	-53.68	-62.72	-17.75	-44.11	-58.30	-58.05	-71.59
24.00	-30.45	-60.09	-60.88	-50.11	-64.58	-24.06	-53.43	-59.79	-57.51	-72.93
25.00	-30.42	-55.23	-57.19	-52.38	-60.63	-25.69	-59.87	-56.93	-59.55	-72.24
26.00	-33.17	-59.23	-53.75	-52.60	-58.41	-26.13	-61.13	-52.61	-57.32	-68.62
27.00	-40.56	-57.98	-50.52	-48.64	-61.89	-30.84	-68.84	-51.44	-54.44	-69.04
28.00	-44.02	-57.87	-47.46	-49.78	-60.65	-32.20	-68.96	-48.96	-56.43	-71.83
29.00	-37.47	-59.19	-52.51	-48.37	-60.08	-33.73	-68.53	-65.66	-57.21	-71.66
30.00	-50.75	-57.35	-45.82	-47.88	-58.60	-40.67	-70.90	-46.08	-51.59	-68.00
31.00	-50.23	--	-48.44	-49.38	-55.28	-41.41	--	-49.09	-52.06	-68.95
32.00	-47.95	--	-42.28	-45.50	-58.65	-39.85	--	-42.59	-49.91	-69.48
33.00	-44.69	--	-33.28	-44.56	-56.09	-35.09	--	-45.85	-49.61	-67.94
34.00	-42.64	--	-30.00	-54.79	-59.46	-33.52	--	-48.08	-60.73	-67.67
35.00	-44.52	--	-53.35	-63.25	-55.36	-35.55	--	-52.26	-68.46	-71.34
36.00	-46.72	--	-52.64	-63.82	-58.27	-37.72	--	-53.86	-70.78	-69.07
37.00	-50.29	--	-54.79	-60.03	--	-44.34	--	-54.79	-72.23	--
38.00	-52.56	--	-44.30	-64.18	--	-47.87	--	-46.08	-67.19	--
39.00	-54.06	--	-31.47	-61.02	--	-51.10	--	-32.18	-59.18	--
40.00	-56.52	--	-33.13	-62.10	--	-57.45	--	-33.31	-61.41	--
41.00	-55.44	--	-33.93	-64.14	--	-57.49	--	-34.26	-64.54	--
42.00	-56.62	--	-32.74	-58.50	--	-57.31	--	-33.04	-66.31	--
43.00	-59.64	--	-23.54	-59.05	--	-56.34	--	-24.84	-58.74	--
44.00	-57.20	--	-13.99	-49.69	--	-61.77	--	-13.01	-39.97	--

**Note:** No sub-harmonics below 22 GHz. Setup limitation limited testing to 90 GHz

### Typical Performance Data

Test Conditions: @ Temperature = 25°C.

Freq. (GHz)	Harmonics levels vs. Output Frequency (dBc)				
	+10 dBm				
	F2	F3	F0.5	F1.5	F2.5
0.10	-33.63	-8.67	--	--	--
0.50	-20.62	-12.19	--	--	--
1.00	-19.19	-12.54	--	--	--
2.00	-18.04	-13.98	--	--	--
3.00	-16.35	-15.29	--	--	--
4.00	-16.40	-14.27	--	--	--
5.00	-16.77	-17.67	--	--	--
6.00	-15.73	-17.25	--	--	--
7.00	-14.85	-20.02	--	--	--
8.00	-14.07	-22.44	--	--	--
9.00	-14.96	-33.69	--	--	--
10.00	-14.69	-33.46	--	--	--
11.00	-13.92	-30.10	--	--	--
12.00	-19.36	-28.86	--	--	--
13.00	-20.67	-27.91	--	--	--
14.00	-22.93	-24.15	--	--	--
15.00	-20.98	-26.14	--	--	--
16.00	-21.95	-25.02	--	--	--
17.00	-23.26	-25.64	--	--	--
18.00	-13.91	-24.68	--	--	--
19.00	-12.94	-27.94	--	--	--
20.00	-10.12	-32.65	--	--	--
21.00	-8.10	-34.24	--	--	--
22.00	-10.61	-30.76	-56.24	-64.33	-74.88
23.00	-8.55	-28.10	-60.93	-60.78	-79.02
24.00	-16.29	-38.36	-62.99	-65.49	-81.67
25.00	-14.91	-44.65	-59.95	-64.63	-80.21
26.00	-15.46	-50.72	-57.12	-64.70	-79.55
27.00	-21.77	-61.20	-51.72	-53.51	-69.83
28.00	-20.44	-63.70	-52.40	-58.94	-77.15
29.00	-26.82	-69.86	-55.23	-55.71	-76.83
30.00	-29.26	-70.46	-49.35	-53.17	-74.81
31.00	-32.20	--	-48.46	-51.25	-79.19
32.00	-31.24	--	-47.48	-53.99	-76.80
33.00	-27.51	--	-45.72	-51.24	-77.20
34.00	-25.61	--	-49.01	-58.11	-78.25
35.00	-27.55	--	-57.32	-66.93	-80.77
36.00	-29.61	--	-60.83	-72.86	-80.47
37.00	-35.18	--	-55.44	-66.96	--
38.00	-39.34	--	-43.36	-59.20	--
39.00	-41.92	--	-33.34	-53.65	--
40.00	-51.52	--	-35.10	-56.98	--
41.00	-49.91	--	-32.59	-56.48	--
42.00	-50.63	--	-34.50	-59.98	--
43.00	-49.91	--	-25.75	-50.01	--
44.00	-56.41	--	-14.01	-37.27	--

**Note:** No sub-harmonics below 22 GHz. Setup limitation limited testing to 90 GHz

# Signal Generator

## SSG-44GHP-RC

### Typical Performance Data

Test Conditions: @ Temperature = 25°C.

Freq. (GHz)	Phase Noise vs. Output Freq. at Frequency Offsets (dBc / Hz)					
	100 Hz	1 kHz	10 kHz	100 kHz	1 MHz	10 MHz
0.10	-100.59	-116.67	-137.36	-141.81	-141.47	-141.85
0.50	-87.82	-102.09	-127.55	-136.93	-134.60	-141.47
1.00	-82.58	-96.24	-118.49	-131.83	-130.02	-139.80
2.00	-75.72	-89.99	-113.09	-125.83	-124.15	-137.79
3.00	-73.56	-87.22	-111.64	-122.33	-116.49	-134.08
4.00	-71.82	-83.86	-107.72	-120.26	-117.38	-134.93
5.00	-65.96	-82.20	-106.66	-119.88	-116.65	-135.17
6.00	-67.67	-81.06	-104.57	-116.72	-110.97	-130.09
7.00	-64.12	-79.68	-102.70	-115.37	-110.37	-130.72
8.00	-62.60	-77.91	-102.49	-113.98	-110.86	-132.12
9.00	-63.20	-78.20	-104.11	-114.79	-111.41	-132.47
10.00	-61.17	-76.33	-102.12	-113.97	-112.43	-132.24
11.00	-61.45	-76.87	-103.54	-113.83	-112.63	-134.95
12.00	-61.32	-75.74	-96.91	-110.11	-104.51	-124.87
13.00	-58.26	-73.80	-98.57	-109.58	-105.42	-125.74
14.00	-56.78	-73.98	-96.47	-109.29	-104.68	-124.66
15.00	-59.96	-72.92	-97.04	-108.63	-105.50	-125.62
16.00	-57.12	-72.14	-95.93	-108.12	-105.56	-126.97
17.00	-57.63	-72.21	-96.12	-108.34	-103.97	-126.36
18.00	-54.49	-71.64	-95.89	-108.71	-106.03	-127.42
19.00	-57.84	-70.57	-95.80	-108.41	-104.13	-126.30
20.00	-56.99	-70.17	-94.33	-107.76	-104.56	-126.65
21.00	-54.07	-69.86	-94.88	-107.19	-107.66	-128.01
22.00	-55.79	-71.01	-95.10	-107.15	-106.05	-130.76
23.00	-53.85	-69.29	-92.02	-104.34	-99.52	-119.91
24.00	-59.25	-69.76	-91.95	-104.52	-99.28	-119.14
25.00	-58.74	-69.05	-92.42	-103.87	-98.67	-118.21
26.00	-50.92	-68.20	-90.50	-103.78	-100.10	-120.18
27.00	-54.59	-68.21	-92.07	-103.44	-98.51	-119.45
28.00	-53.05	-68.10	-91.99	-103.14	-99.22	-119.29
29.00	-52.94	-67.47	-91.28	-102.85	-98.95	-120.56
30.00	-52.91	-66.80	-90.30	-103.09	-99.54	-119.41
31.00	-52.73	-66.13	-91.18	-104.15	-98.43	-119.85
32.00	-50.51	-66.11	-91.71	-102.13	-100.50	-121.10
33.00	-49.70	-65.80	-90.55	-101.95	-99.19	-120.96
34.00	-53.41	-66.08	-90.39	-102.37	-98.29	-119.95
35.00	-52.41	-65.99	-90.91	-102.75	-97.56	-119.60
36.00	-52.94	-65.73	-89.98	-102.76	-101.35	-120.16
37.00	-52.13	-65.66	-90.38	-102.28	-97.99	-119.43
38.00	-49.07	-64.74	-88.26	-102.35	-98.24	-119.55
39.00	-50.86	-64.48	-90.13	-101.91	-99.85	-120.46
40.00	-51.06	-64.33	-90.13	-101.79	-99.81	-120.46
41.00	-51.57	-63.77	-86.65	-100.97	-99.02	-120.20
42.00	-51.34	-63.97	-89.93	-101.29	-100.87	-120.83
43.00	-49.95	-64.82	-89.41	-101.27	-100.58	-122.03
44.00	-51.32	-64.62	-89.09	-101.55	-99.64	-121.63

Freq. (GHz)	Spurious (dBc)
0.50	-72.61
1.00	-68.48
2.00	-64.11
3.00	-58.78
4.00	-58.98
5.00	-57.59
6.00	-52.57
7.00	-53.61
8.00	-50.23
9.00	-49.99
10.00	-52.71
11.00	-51.54
12.00	-46.80
13.00	-47.06
14.00	-47.12
15.00	-46.62
16.00	-46.68
17.00	-44.19
18.00	-49.07
19.00	-46.79
20.00	-47.09
21.00	-47.24
22.00	-46.82
23.00	-39.83
24.00	-38.58
25.00	-41.21
26.00	-43.27
27.00	-38.33
28.00	-40.32
29.00	-39.63
30.00	-39.24
31.00	-36.50
32.00	-40.46
33.00	-38.41
34.00	-38.56
35.00	-37.10
36.00	-42.22
37.00	-41.41
38.00	-38.74
39.00	-40.51
40.00	-38.29
41.00	-40.33
42.00	-40.11
43.00	-44.61
44.00	-41.05

## Typical Performance Graphs

Test Conditions: @ Temperature = 25°C.

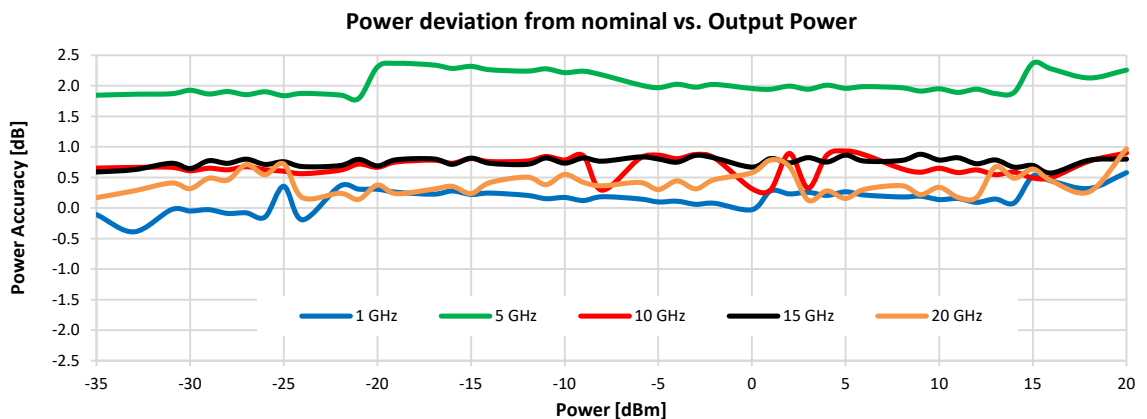
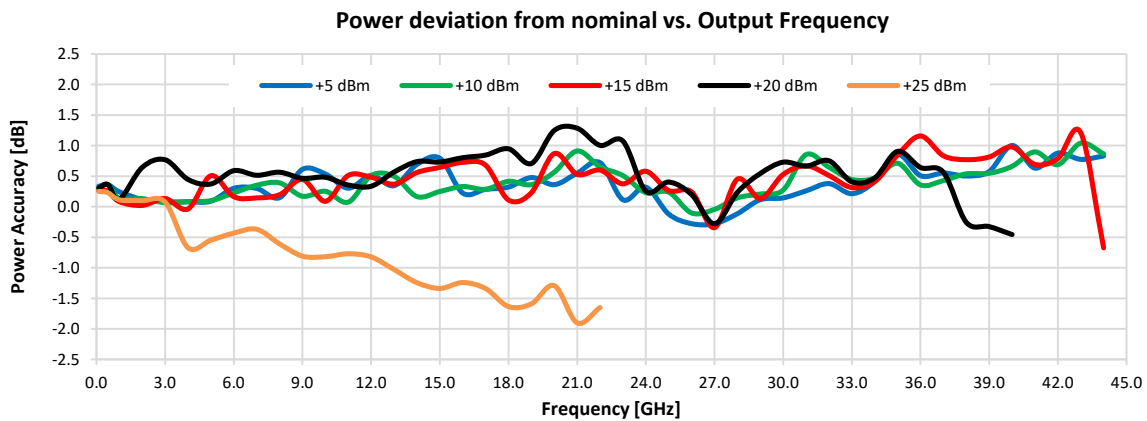
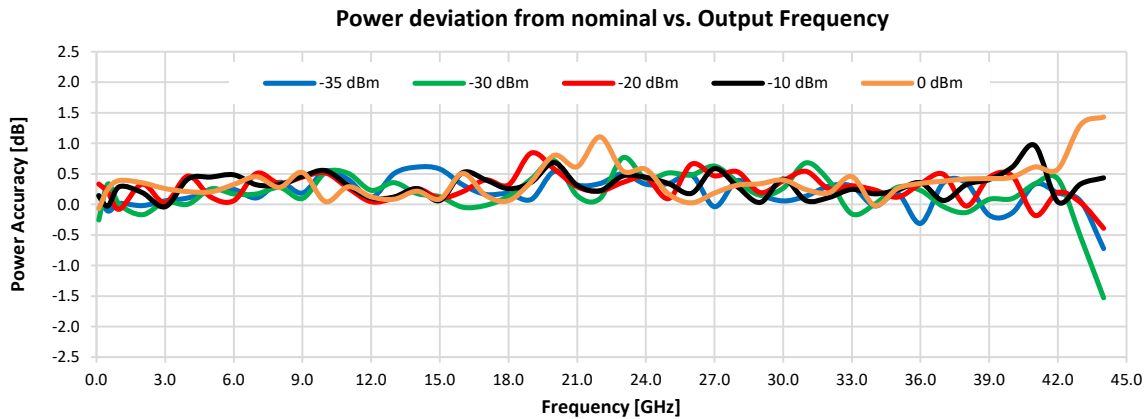

## Typical Performance Graphs

Test Conditions: @ Temperature = 25°C.

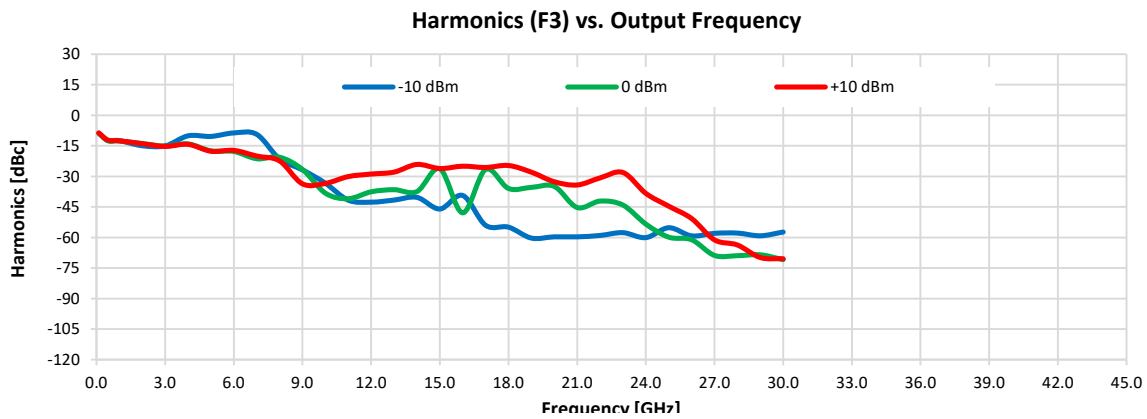
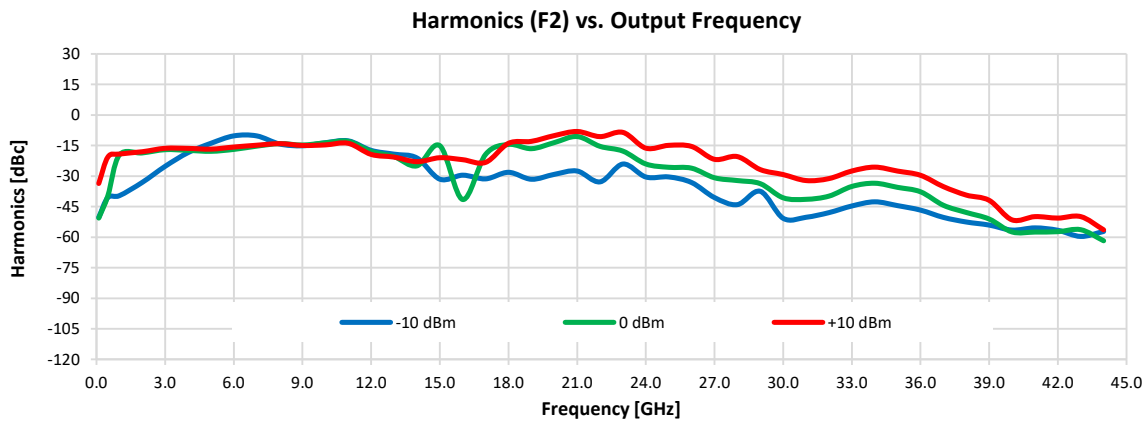
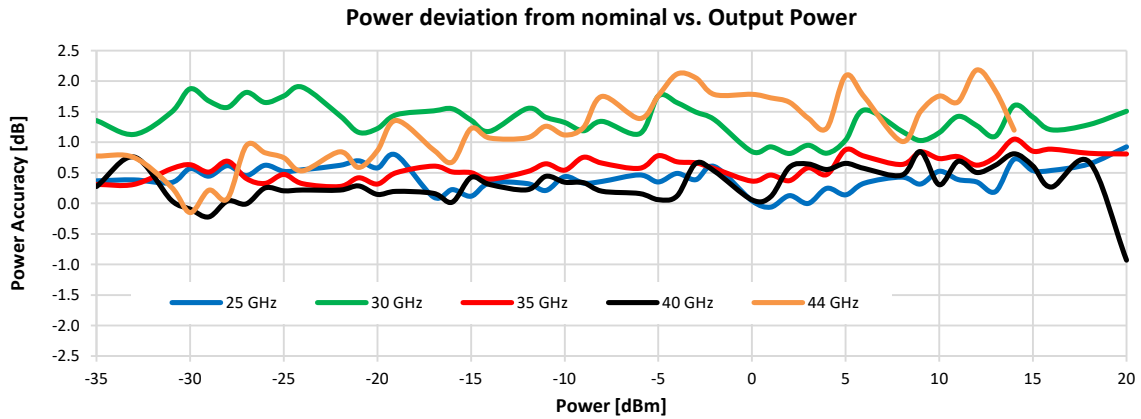

## Typical Performance Graphs

Test Conditions: @ Temperature = 25°C.

frequency [GHz]

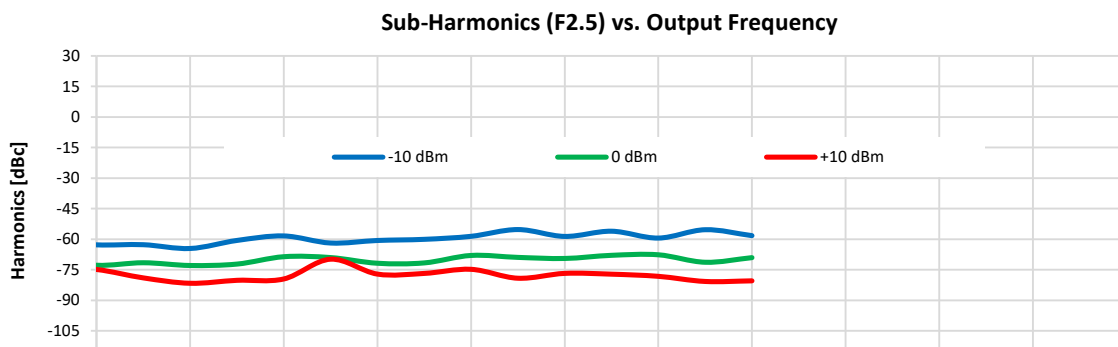
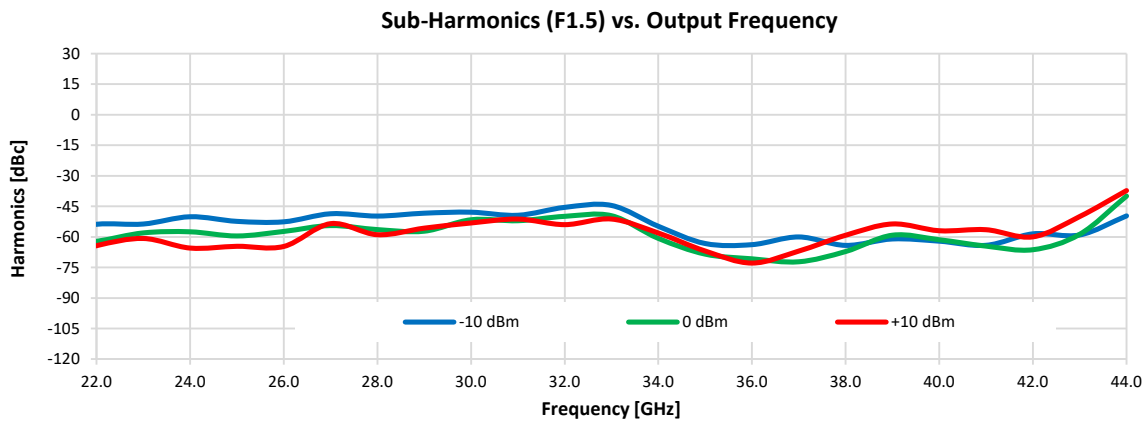
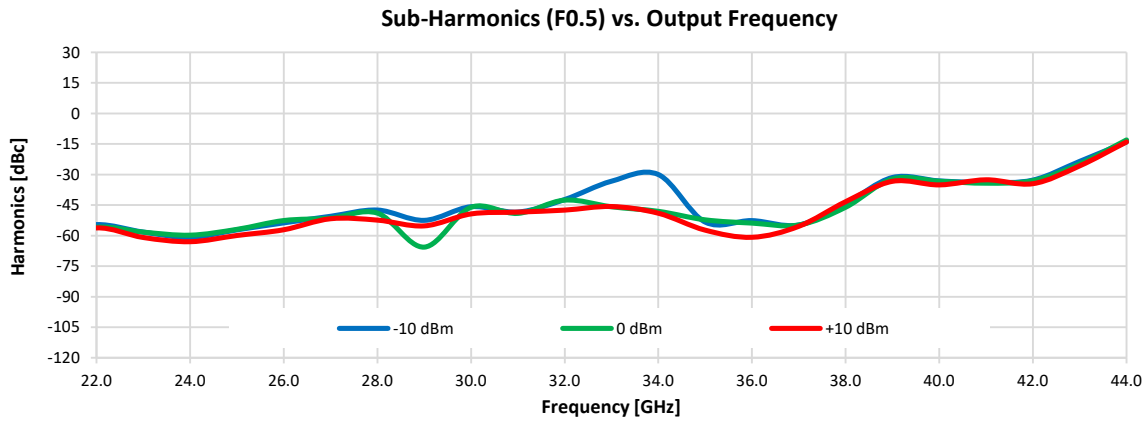

## Typical Performance Graphs

Test Conditions: @ Temperature = 25°C.

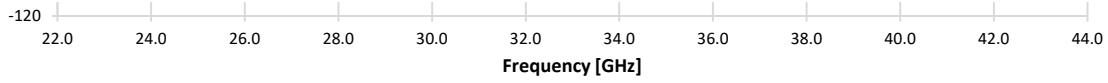

### Phase Noise vs. Output Freq. at Frequency Offsets

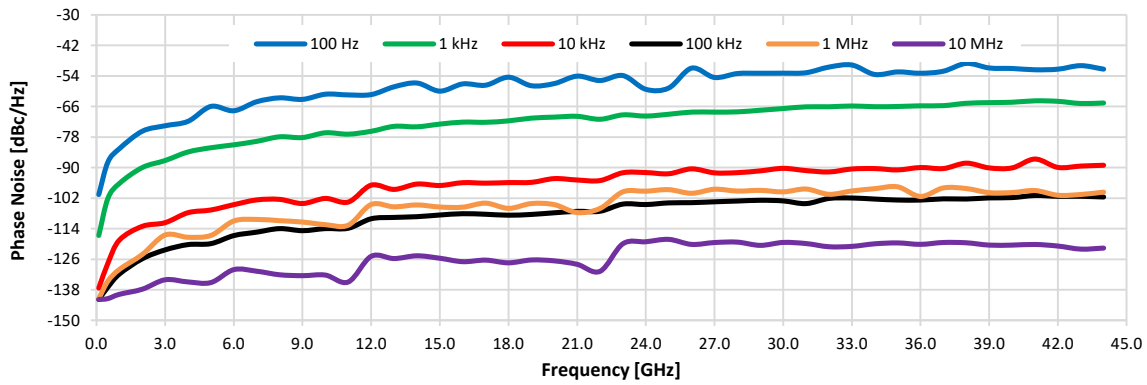

### Phase Noise vs. Offset Freq. at Frequency Output

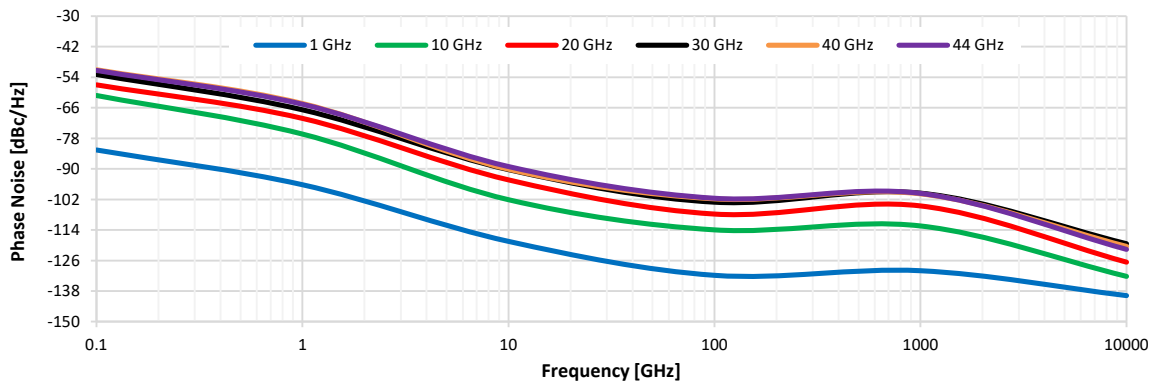

### Spurious vs. Output Frequency @ PWR= +5 dBm

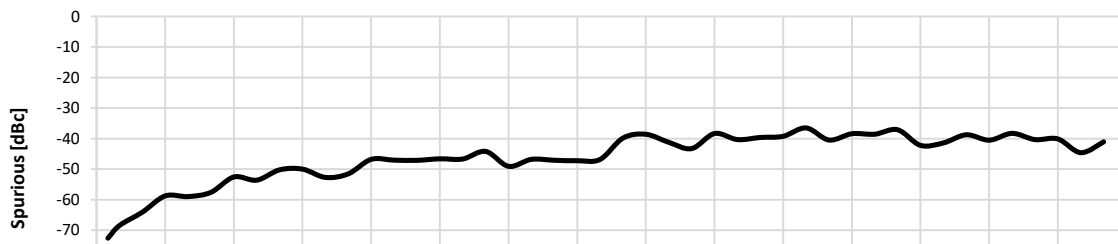

# Case Style

# SL

## Outline Dimensions

## SL3483

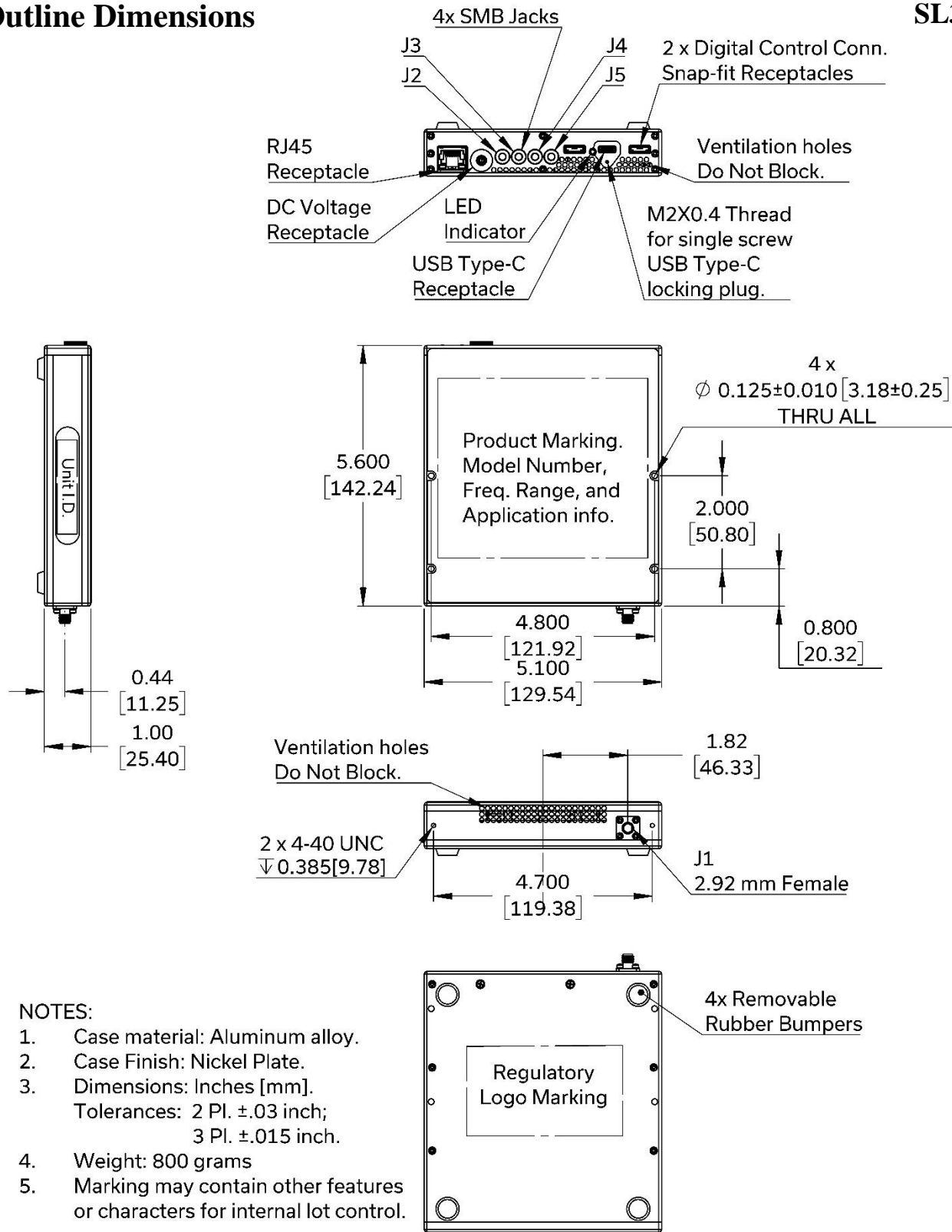

**NOTES:**

1. Case material: Aluminum alloy.
2. Case Finish: Nickel Plate.
3. Dimensions: Inches [mm].  
Tolerances: 2 Pl.  $\pm 0.03$  inch;  
3 Pl.  $\pm 0.015$  inch.
4. Weight: 800 grams
5. Marking may contain other features or characters for internal lot control.



[www.minicircuits.com](http://www.minicircuits.com) P.O. Box 350166, Brooklyn, NY 11235-0003 (718) 934-4500 sales@minicircuits.com





Environmental Specifications **ENV55**

All Mini-Circuits products are manufactured under exacting quality assurance and control standards, and are capable of meeting published specifications after being subjected to any or all of the following physical and environmental test.

Specification	Test/Inspection Condition	Reference/Spec
Operating Temperature	-0° to 50° C Ambient Environment	Individual Model Data Sheet
Storage Temperature	-20° to 60° C Ambient Environment	Individual Model Data Sheet
Operating and Storage Humidity	5% to 85% RH (non-condensing)	Ambient
Bench Handling Test	Bench Top Tip 45° & Drop	MIL-PRF-28800F
Transit Drop Test	Free Fall Drop, 20 cm (7.9 inches)	MIL-PRF-28800F Class 3