



USB & ETHERNET

Signal Generator

SSG-30GHP-RC

50Ω 0.01 to 30 GHz -38 dBm to +27 dBm 2.92 mm female

THE BIG DEAL

- Cost effective millimeter wave signal source
- High output power @ 30 GHz, +22 dBm
- Pulse modulation with 0.5 μs pulse width
- USB and Ethernet control

APPLICATIONS

- 5G FR2 bands n257, n258 & n261
- High power burn-in / life testing
- K & Ku band radar
- Wideband LO source
- Microwave & millimeter wave radio testing



Generic photo used for illustration purposes only.

PRODUCT OVERVIEW

Mini-Circuits' SSG-30GHP-RC is a wide-band signal generator offering CW and pulsed outputs from 10 MHz to 30 GHz. With +25 dBm typical output power up to 25 GHz and +22 dBm typical up to 30 GHz, the SSG is an ideal signal source for characterization of millimeter wave components and systems at high power. Configure CW / single-tone outputs at any supported frequency and power level; flexible pulse sequences with pulse widths down to 0.5 μs; or automated frequency / power sweep & hop sequences.

SSG-30GHP-RC uses a unique modular construction to provide a high power, millimetre wave signal source at an affordable price point for every lab and production test setup. The unit is supplied ready-assembled assembled, with a semi-rigid cable integrating the modules and a precision 2.92 mm output connector on the front panel. Simply connect the serial interface cable on the rear, USB or Ethernet for control and then the power supplies to get started.

The system is controlled via Ethernet or USB using Mini-Circuits' powerful signal generator GUI for Windows, or the comprehensive API. SSH, HTTP & Telnet protocols are supported via Ethernet, with programming support for most common languages.

KEY FEATURES

Feature	Advantages
High output power	Reliable high power signal source for millimeter wave systems, reducing the need for external amplification and gain control.
Flexible pulse modulation	Configure pulse sequences with varying frequency, power, pulse width and pulse repetition interval (PRI).
Sweep & hop sequences	Configure custom CW output frequency and power sequences to run unaided for high speed, automated test applications.
USB & Ethernet control	USB HID and Ethernet (HTTP / Telnet / SSH) interfaces provide easy compatibility with a wide range of software setups and programming environments.

Trademarks:

Windows is a registered trademark of Microsoft Corporation in the United States and other countries; Linux is a registered trademark of Linus Torvalds; Pentium is a registered trademark of Intel Corporation. Neither Mini-Circuits nor the Mini-Circuits products are affiliated with or endorsed by the owners of the referenced trademarks. Mini-Circuits and the Mini-Circuits logo are registered trademarks of Scientific Components Corporation.





ELECTRICAL SPECIFICATIONS AT +25°C

Parameter	Condition (GHz)	Min.	Typ.	Max.	Unit
Output Frequency	-	0.01		30	GHz
Frequency Resolution ¹	0.01 - 15	-	0.1	-	Hz
	15 - 30	-	0.2	-	
Frequency Accuracy	Using Internal Reference	-	±1	-	ppm
Settling Time ^{2,4}	Hop Mode ³	-	0.2	0.3	ms
	Frequency Sweep ³	-	0.6	0.8	
	PC Control (External)	-	1.2	5.0	
Dwell Time (nominal) ^{4,5}	-	0.01	-	10,000	ms
Return Loss	0.01 - 15	-	18.0	-	dB
	15 - 27	-	16.5	-	
	27 - 30	-	11.0	-	
Output Power Max ⁶	0.01 - 12	+25	+27	-	dBm
	12 - 25	+22	+25	-	
	25 - 30	+19	+22	-	
Output Power Min ⁶	0.01 - 30	-	-38	-30	dBm
Output Power Accuracy ⁶	0.01 - 30	-	±1.00	-	dB
Power Resolution (nominal) ⁷	0.01 - 15	-	0.5	-	dB
RF Off Output Level	0.01 - 30	-	-90	-	dBm
Harmonics ⁸	0.01 - 2	-	-9	-	dBc
	2 - 8	-	-20	-	
	8 - 15	-	-30	-	
	15 - 30	-	-35	-	
Sub-Harmonics ^{8,9}	15 - 30	-	-40	-	dBc
Non-Harmonic Spurious	-	-	-60	-	dBc

1. Frequency Resolution is tested with 10 MHz external reference.

2. Settling Time - transition time between 2 output states. During the transition, RF output is turned off to avoid transient outputs.

3. For Sweep / Hop sequences pre-loaded into internal memory (high-speed mode).

4. Generator response time is Dwell Time + Settling Time.

5. Dwell Time - duration of each signal point in a sweep or hop sequence set by user. Default is minimum Dwell Time.

6. After 15 minutes warm-up time.

7. At power steps below 0.5 dB increased non-monotonic behavior may be observed.

8. Harmonic & Sub-Harmonics at low power out above 15 GHz are primarily due to leakage from the doubler input via low frequency channel.

9. No Sub-Harmonics below 15 GHz.



TYPICAL PHASE NOISE (SSB) AT +25°C

Carrier Frequency (GHz)	Frequency Offset (dBc / Hz)				
	0.1 kHz	1 kHz	10 kHz	100 kHz	1000 kHz
0.05	-115	-128	-130	-129	-130
0.20	-104	-123	-127	-128	-130
0.40	-97	-118	-125	-124	-130
0.80	-93	-112	-120	-118	-128
1.60	-85	-106	-113	-113	-127
3.20	-82	-101	-109	-107	-125
6.40	-76	-95	-103	-101	-120
12.80	-69	-89	-96	-95	-117
15.00	-66	-87	-95	-94	-113
30.00	-61	-81	-89	-87	-109

REGULAR PULSE MODULATION SPECIFICATIONS AT +25°C

Repetitive RF pulse sequences with fixed frequency and power, supporting internal or external modulation and input / output trigger options.

Parameter	Condition	Min.	Typ.	Max.	Unit	
Pulse Width Resolution	Nominal value	0.05	-	-	μs	
Pulse Width ^{10, 11}	Measured at the 50% of pulse level	0.5	-	10e6	μs	
Pulse Period ¹⁰	Measured at the 50% of pulse level	2	-	10e6	μs	
Duty Cycle (in Free Run)	Pulse Width divided by Pulse Period	0.0001	-	99.9999	%	
Rise / Fall Time ¹²	Measured between 10% and 90% of pulse level	-	0.1 / 0.02	-	μs	
Pulse Width Accuracy ¹³	Measured at 50% of pulse level	Internal Pulse Modulation	-	±3	-	%
		External Pulse Modulation	-	±3	-	
External Pulse Modulation Input Threshold	External Pulse Modulation	-	-	3	V	
Trigger Response Delay	Trigger edge to 50% of pulse level	-	1	-	μs	
Pulse Power Ratio	PWR _{OUT} = 0 dBm, FREQ _{OUT} = 10 MHz	-	58	-	dB	
	PWR _{OUT} = +10 dBm, FREQ _{OUT} = 30 GHz	-	50	-		

10. Pulse Width must be less than pulse period by at least 0.5 μs.

11. Pulse Widths below 0.5 μs can be set, however performance is only guaranteed for 0.5 μs and up.

12. Pulse Rise Time will increase with pulse interval under 3 μs.

13. Pulse Width Accuracy is 3% of pulse width, or ±100 ns, whichever is greater.

**DYNAMIC PULSE MODULATION SPECIFICATIONS AT +25°C**

Flexible RF pulse sequences with varying frequency, power, pulse width and pulse repetition interval (PRI).

Parameter	Condition		Min.	Typ.	Max.	Unit
Pulse Width Resolution	Nominal value		0.05	-	-	μs
Pulse Width ^{10, 11}	Measured at the 50% of pulse level		0.5	-	4e6	μs
Pulse Interval	Fixed Freq. & Power	Measured at the 50% of pulse level	4.5	-	4e6	μs
	Varying Freq. or Power	Measured at the 50% of pulse level	300	-	4e6	
Duty Cycle (in Free Run)	Pulse Width divided by Pulse Period		0.0001	-	99.9999	%
Rise / Fall Time ¹²	Measured between 10% and 90% of pulse level		-	0.1 / 0.02	-	μs
Pulse Width Accuracy ¹³	Measured at 50% of pulse level	Internal Pulse Modulation	-	±3	-	%
Pulse Power Ratio ¹⁴	PWR _{OUT} = 0 dBm, FREQ _{OUT} = 10 MHz		-	58	-	dB
	PWR _{OUT} = +10 dBm, FREQ _{OUT} = 30 GHz		-	50	-	

10. Pulse Width must be less than pulse period by at least 0.5 μs.

11. Pulse Widths below 0.5 μs can be set, however performance is only guaranteed for 0.5 μs and up.

12. Pulse Rise Time will increase with pulse interval under 3 μs.

13. Pulse Width Accuracy is 3% of pulse width, or ±100 ns, whichever is greater.

14. Average Power Ratio of the signal in the "on" portion of the pulse to the average power of the signal in the "off" portion of the pulse.

REFERENCE, TRIGGER & DC POWER AT +25°C

Parameter	Condition		Min.	Typ.	Max.	Unit
Aging	Using Internal Reference		-	2	-	ppm/yr
Reference In	Frequency	-	-	10	-	MHz
	Power	-	-3.5	-	+7.5	dBm
	Phase Noise	10kHz Offset	-	-145	-	dBc/Hz
Reference Out	Frequency	-	-	10	-	MHz
	Frequency Accuracy	Using Internal Reference	-	±1	-	ppm
	Power	-	-	±5.5	-	dBm
Trigger Out ¹⁴	Low		0	-	0.4	V
	High		3	-	5	
Trigger In	Low		0	-	0.4	
	High		3	-	5	
Supply Voltage (lower)	-		5.6	6	6.4	V _{DC}
Supply Voltage (upper)	-		11.4	12	12.6	
Supply Current, 6V (lower) ¹⁵	-		-	1250	1850	mA
Supply Current, 12V (upper)	-		-	650	800	
USB Current ¹⁶	-		-	0	-	

15. Trigger Out voltage specified with impedance load of 10 kΩ minimum.

16. All power is drawn from power adaptor, USB is used for control only.



TYPICAL PERFORMANCE GRAPHS

Power Accuracy vs. Output Frequency

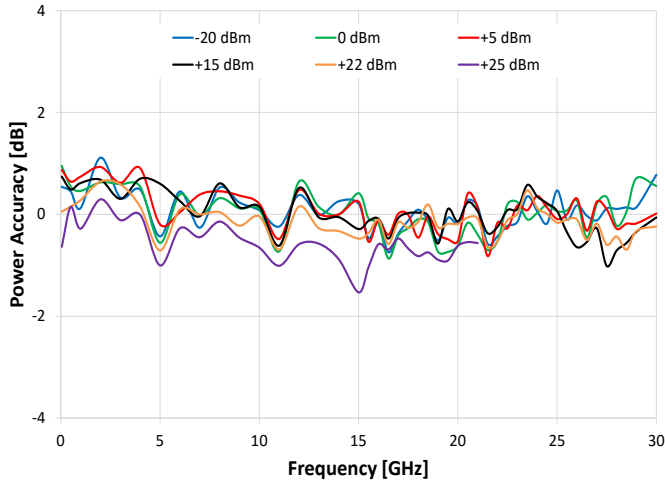

Power Accuracy vs. Output Power

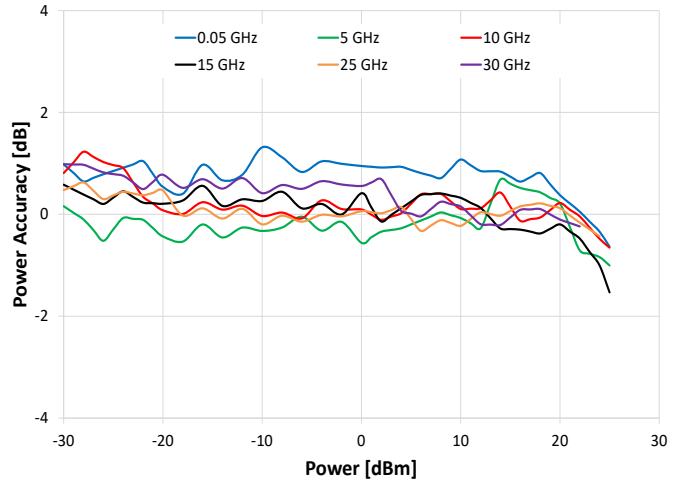

Phase Noise vs. Output Freq. at Frequency Offsets

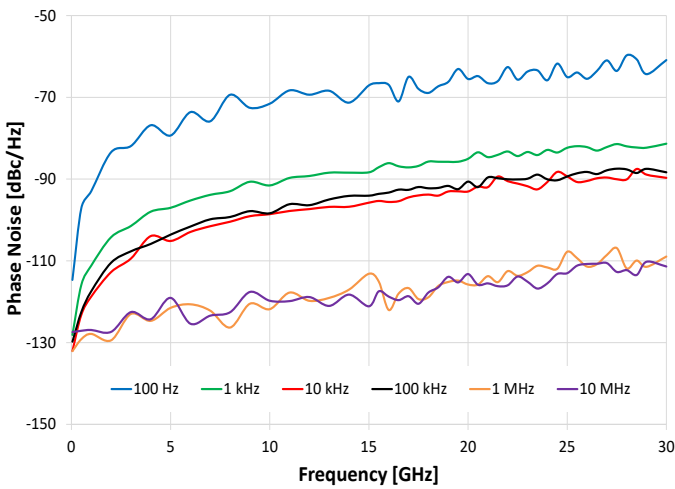

Phase Noise vs. Offset Freq. at Frequency Output

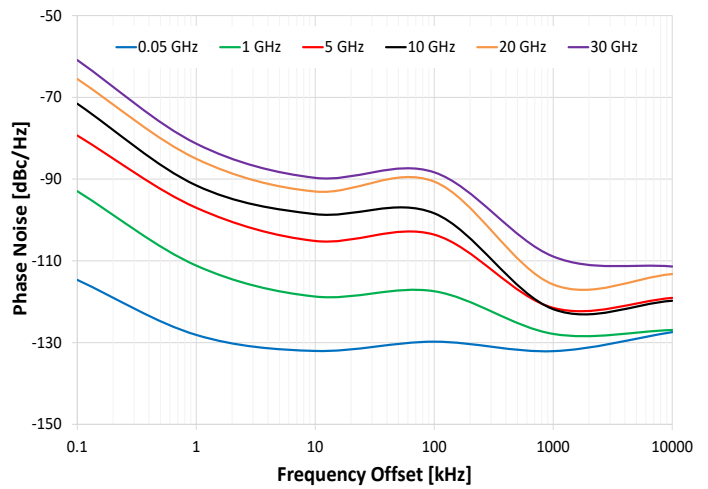

Spurious vs. Output Frequency @ PWR= +14 dBm

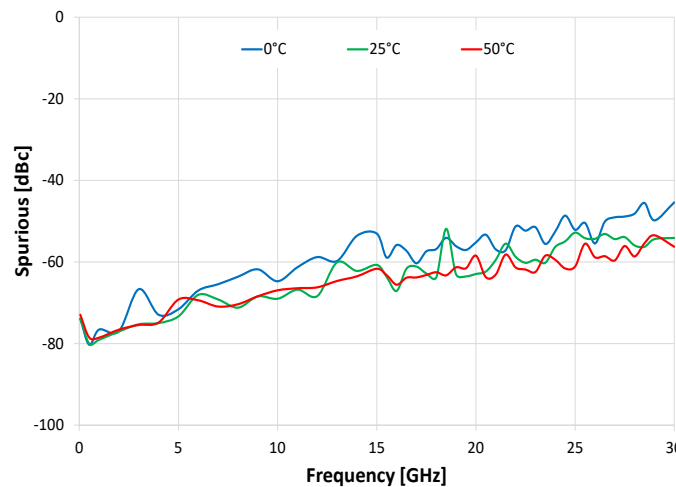



TYPICAL PERFORMANCE GRAPHS (CONTINUED)

Harmonics vs. Output Frequency @ -20 dBm

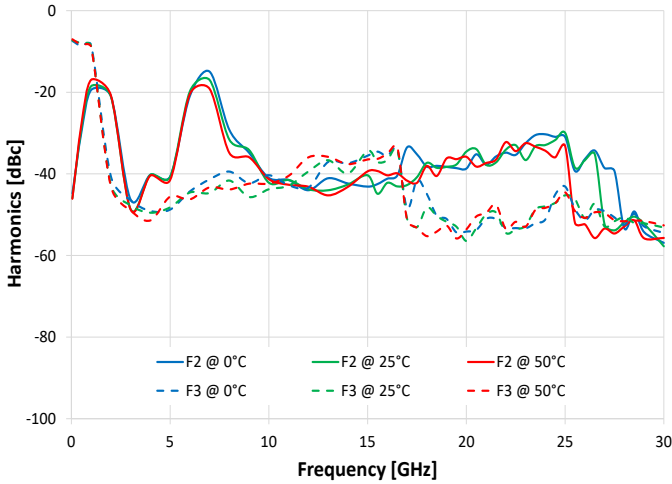

Sub-Harmonics vs. Output Frequency @ -20 dBm

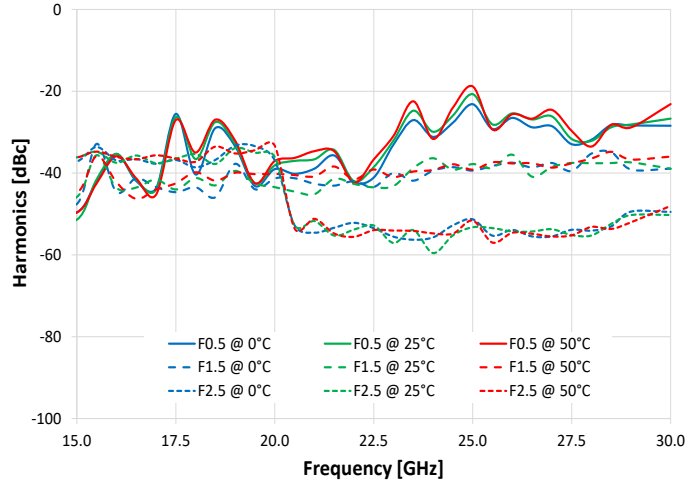

Harmonics vs. Output Frequency @ +10 dBm

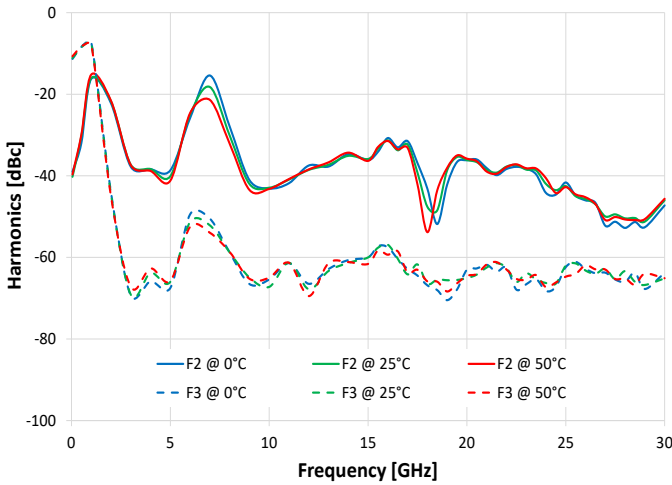

Sub-Harmonics vs. Output Frequency @ +10 dBm

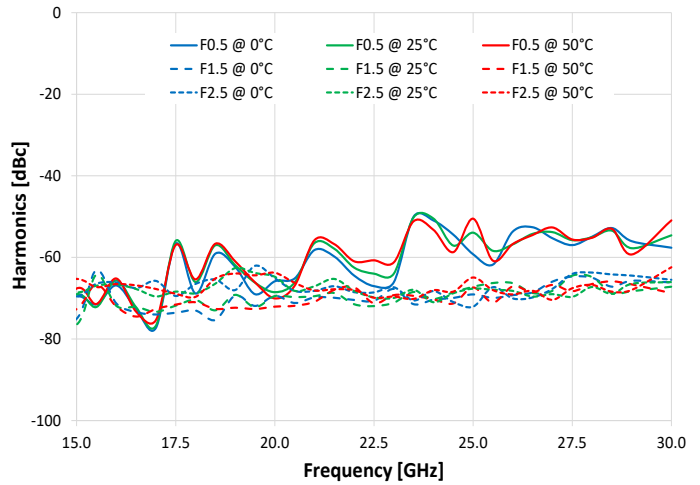

Harmonics vs. Output Frequency @ +20 dBm

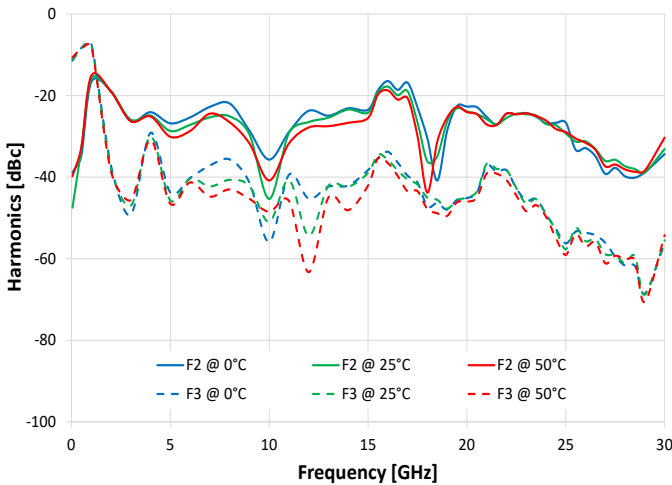

Sub-Harmonics vs. Output Frequency @ +20 dBm

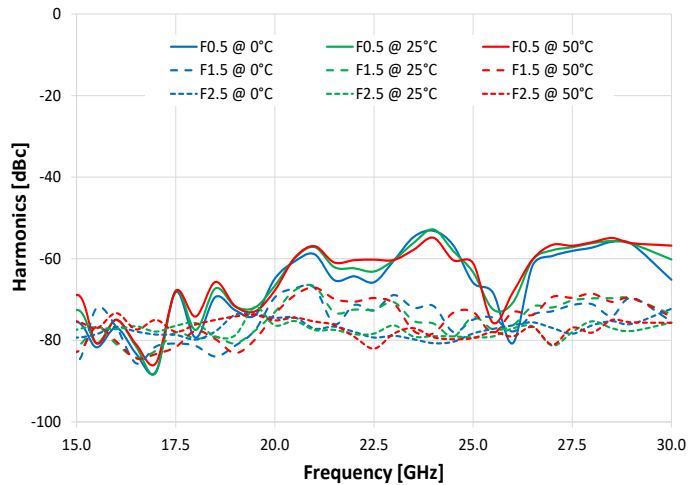



CONTROL INTERFACES

Ethernet Control	Supported Protocols	TCP / IP, HTTP, Telnet, SSH, DHCP, UDP (limited)
	Max Data Rate	100 Mbps (100 Base-T Full Duplex)
USB Control	Supported Protocols	HID (Human Interface Device) - High-speed
	Min Communication Time ¹⁷	500 μs typ (full transmit/receive cycle)

17. USB Min Communication Time is based on the polling interval of the USB HID protocol (125 μs polling interval, 64 bytes per packet), medium CPU load and no other high-speed USB devices using the USB bus.

SOFTWARE & DOCUMENTATION

Mini-Circuits' full software and support package including user guide, Windows GUI, API, programming manual and examples can be downloaded free of charge (refer to the last page for the download path).

A comprehensive set of software control options is provided:

- GUI for Windows – Simple software interface for control via Ethernet and USB.
- Programming / automation via Ethernet:
 - Complete set of control commands which can be sent via any supported protocol.
 - Simple to implement in the majority of modern programming environments.
- Programming / automation via USB:
 - DLL files provide a full API for Windows with a set of intuitive functions which can be implemented in any programming environment supporting .Net Framework or ActiveX.
 - Direct USB programming is possible in any other environment (not supporting .Net or ActiveX).

Please contact testsolutions@minicircuits.com for support.

MINIMUM SYSTEM REQUIREMENTS

GUI	Windows 7 or later
USB API DLL	Windows 7 or later and programming environment with ActiveX or .NET support
USB Direct Programming	Linux, Windows 7 or later
HTTP, Telnet or SSH	Any computer with a network port and Ethernet-TCP/IP (HTTP, Telnet or SSH protocols) support
Hardware	Intel i3 (or equivalent) or later



GRAPHICAL USER INTERFACE (GUI) FOR WINDOWS - KEY FEATURES

- Connect via USB or Ethernet
- Password protected access for safe remote usage over Ethernet

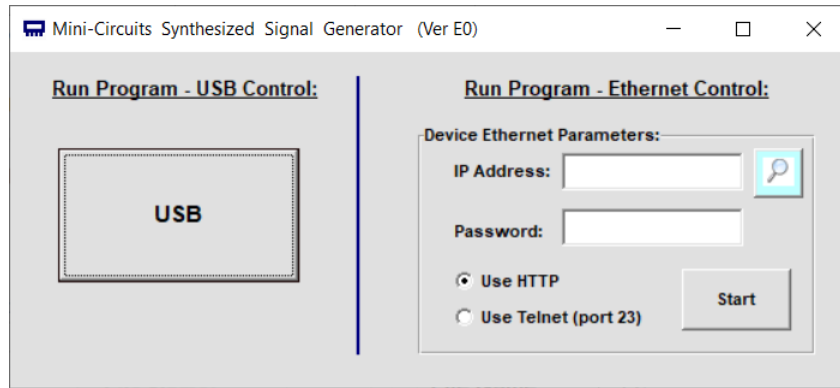

- Configure output power, frequency, pulse modulation
- Program timed signal output sequences (linear sweep and frequency hop)
- Control timed sequences in multiple generators simultaneously
- Track unit operation time since last calibration and setup calibration reminders

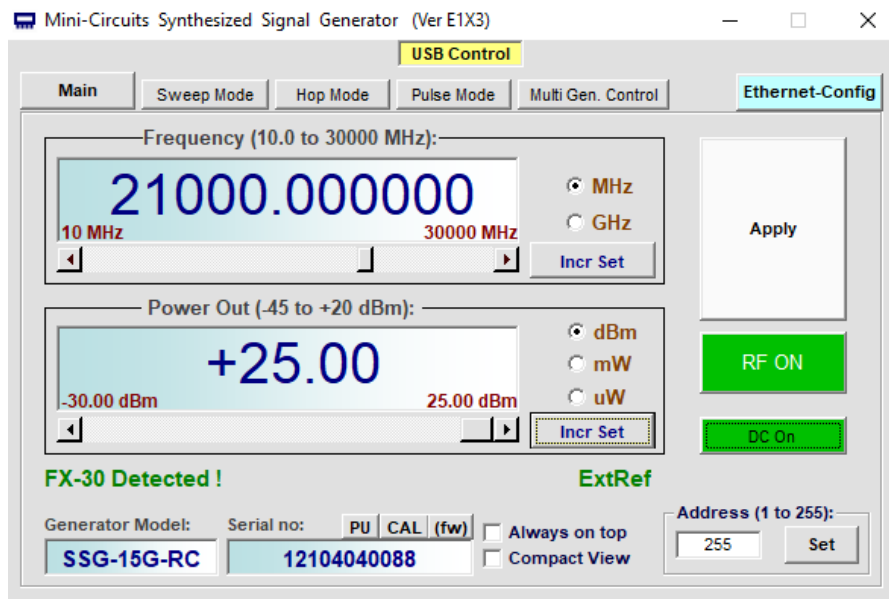



AUTOMATED SWEEP / HOP SEQUENCES

- Sweep across a frequency band at a fixed output power.
- Sweep output power levels at a fixed frequency.
- Hop through a list of pre-defined frequency / power settings.
- Set dwell times down to 10 μs in high speed mode.
- Run on demand or in response to external triggers.
- Produce triggers to signal switching points or completing a run.

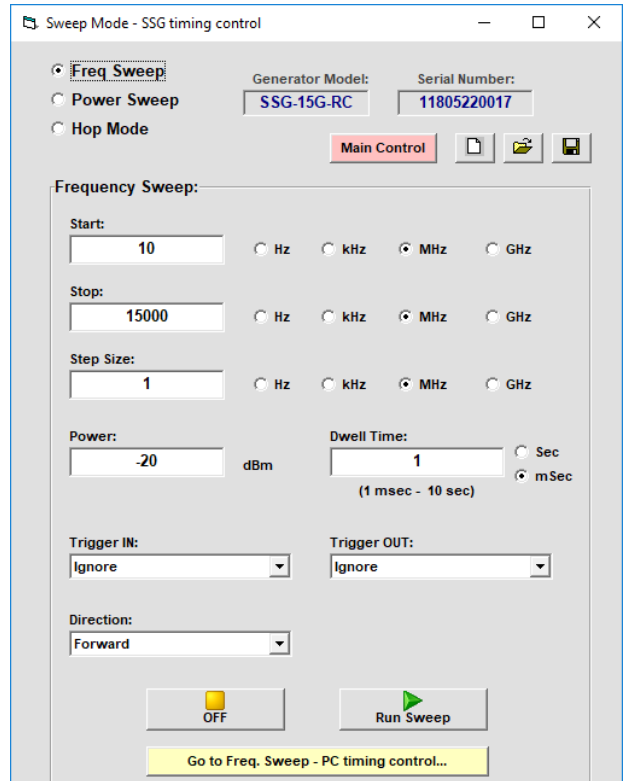

DYNAMIC PULSE MODULATION

- Configure repetitive pulsed output sequences.
- Define custom pulse lists with a different frequency, power, width & interval at each step.
- Set pulse widths down to 0.5 us.
- Run continuously or for a preset number of cycles.

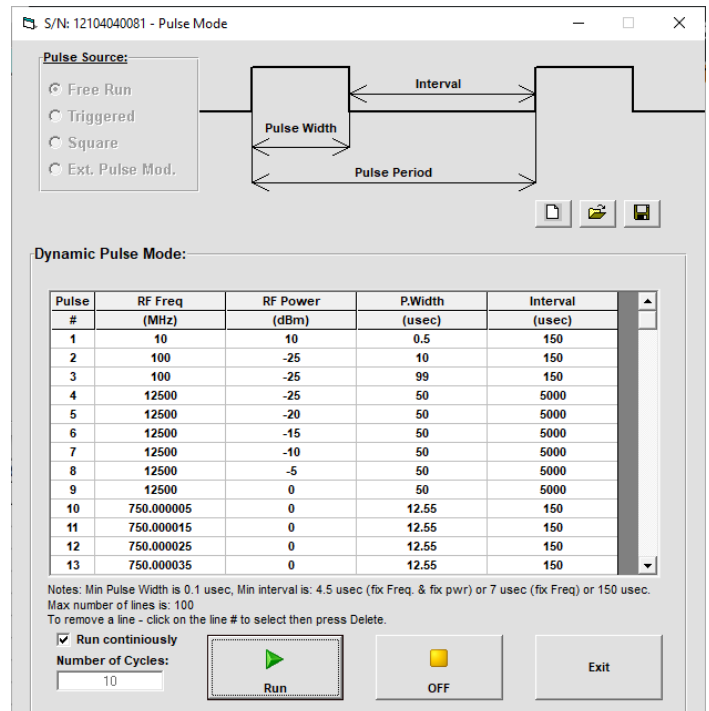



BLOCK DIAGRAM

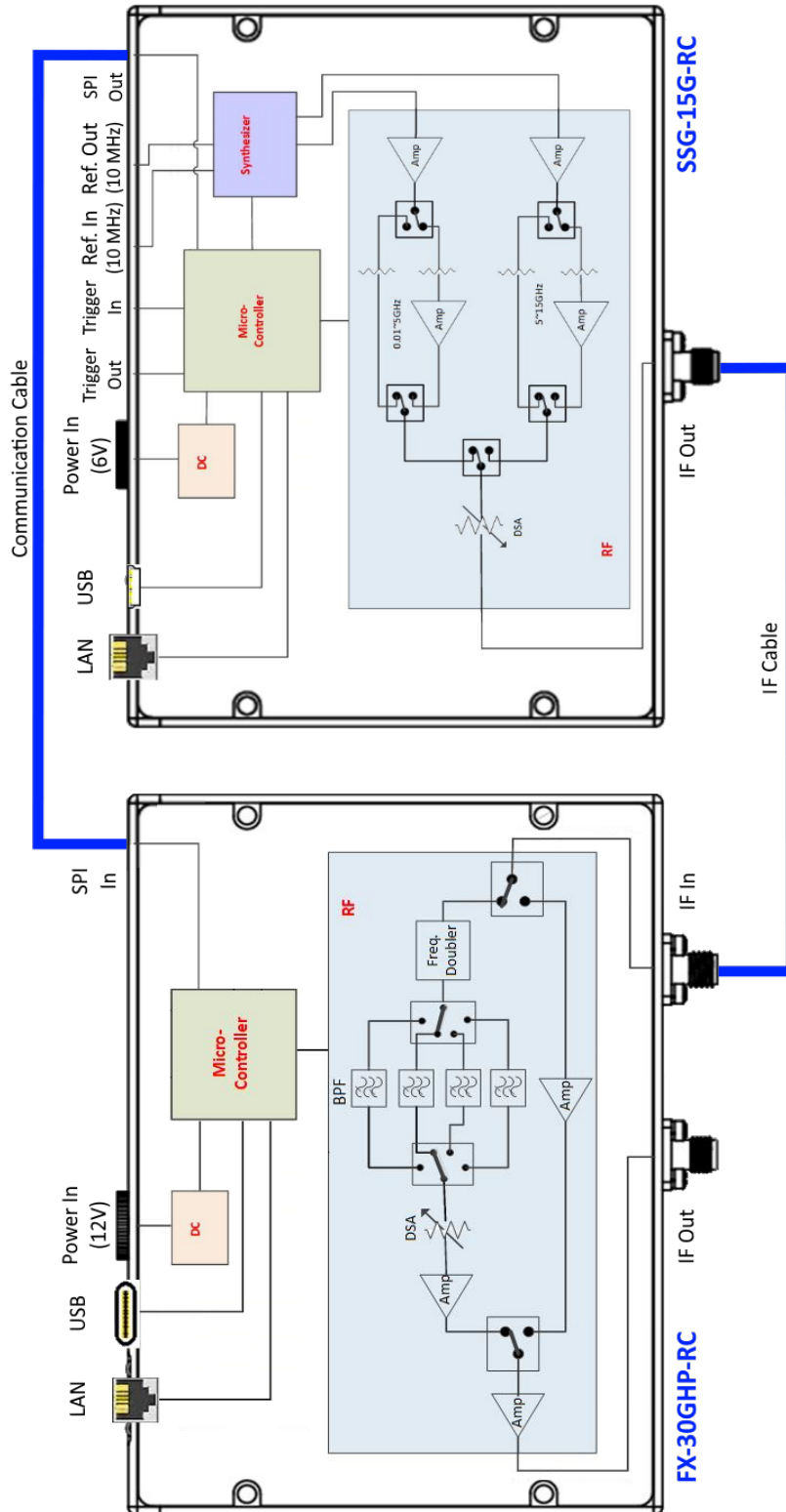

Notes:
 USB / Ethernet control connection(s) are made to the SSG-15G-RC module. The USB / Ethernet connections on the FX-30GHP-RC model are not used in this configuration. The appropriate DC power supplies must be connected to both modules.



CASE STYLE DRAWING (SL3512)

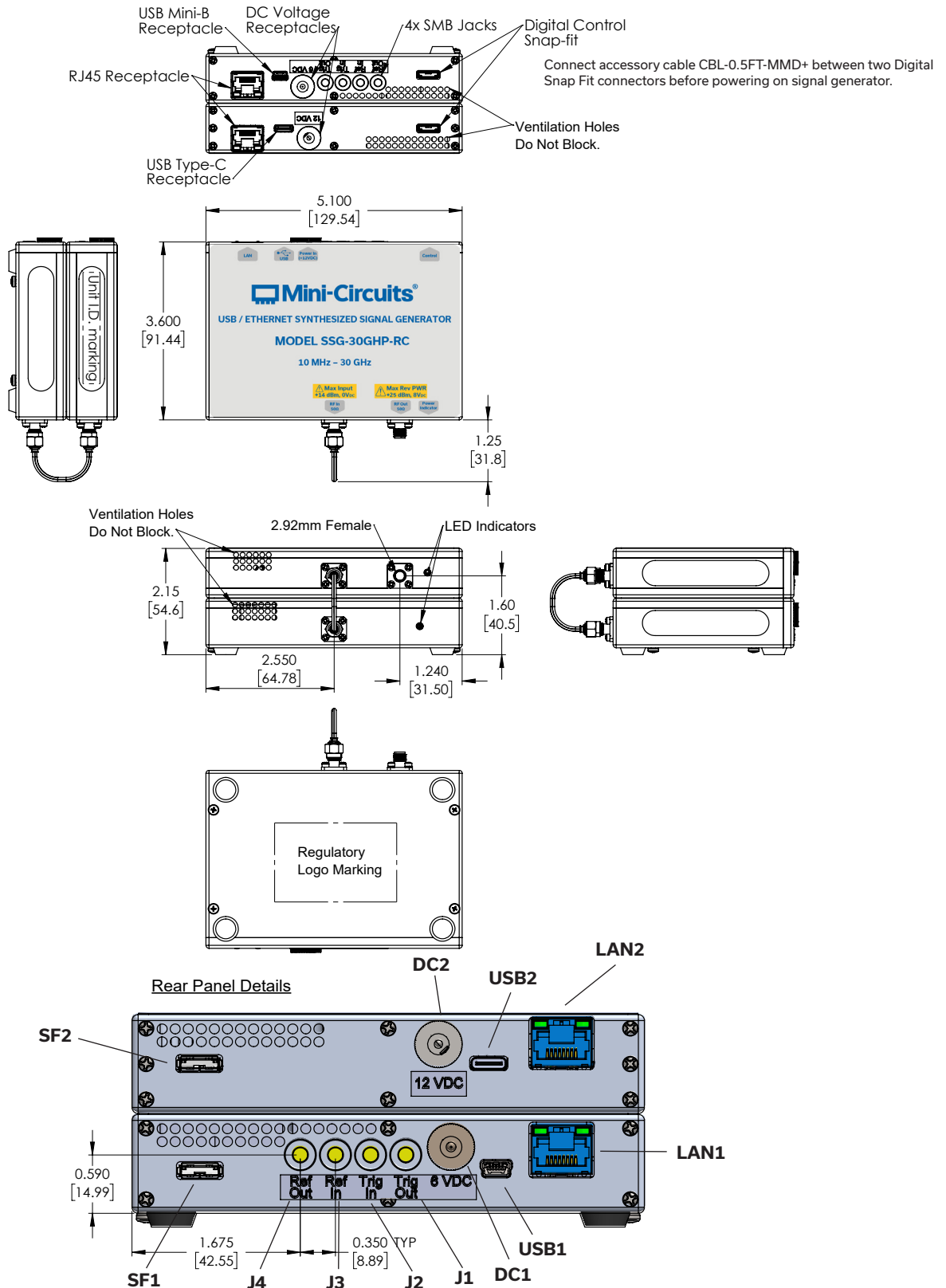



CONNECTIONS

Name	Connector Type	Description
J1	SMB Male	Trigger Out
J2	SMB Male	Trigger In
J3	SMB Male	Reference In
J4	SMB Male	Reference Out
DC1	2.1 mm DC Socket	DC Power In (6V) ¹⁸
USB1	USB Type Mini-B Female	USB Port for control of the module
LAN1	RJ45 Socket	Network (Ethernet/LAN)
SF1	Digital Snap Fit	Serial Control Interconnection, connect accessory cable between SF1 & SF2
J5	2.92 mm Female	RF Output
DC2	2.1 mm DC Socket	DC Power In (12V) ¹⁸
USB2	USB Type C	USB Port for factory usage
LAN2	RJ45 Socket	Network for factory usage
SF2	Digital Snap Fit	Serial Control Interconnection, connect accessory cable between SF1 & SF2

18. No power On/Off switch - SSG will power on as soon as power is connected, starting at the specified startup condition (factory default set to 15 GHz, -45 dBm, RF Off).

ABSOLUTE MAXIMUM RATINGS ^{19, 20}

Operating Temperature		0°C to 50°C
Storage Temperature		-20°C to 60°C
Power In @ Reference In		+10 dBm
Reverse Power (DC) @ Reference Out		8 V _{DC}
Reverse Power (DC) @ RF Out		16 V _{DC}
Reverse Power (RF) @ RF Out ²¹	0.01 - 25 GHz	+28 dBm
	25 - 30 GHz	+25 dBm
Voltage Input to Trigger Ports		-0.3V _{DC} to +5.5V _{DC}

19. Permanent damage may occur if any of these limits are exceeded.

20. Operating in the range between operating power limits and absolute maximum ratings for extended periods of time may result in reduced life and reliability.

21. Model can handle max output power into Open or Short.



USB & ETHERNET

Signal Generator

SSG-30GHP-RC





Mini-Circuits

50Ω 0.01 to 30 GHz -38 dBm to +27 dBm 2.92 mm female





DETAILED MODEL INFORMATION IS AVAILABLE ON OUR WEBSITE [CLICK HERE](#)

Performance Data & Graphs	Data Graphs
Case Style	SL3512
Environmental Rating	ENV55
Software, User Guide & Programming Manual	https://www.minicircuits.com/softwaredownload/sg.html
Regulatory Compliance	<p>Refer to user guide for compliance information</p>  <p>https://www.minicircuits.com/app/AN49-003.pdf</p>
Support	testsolutions@minicircuits.com

INCLUDED ACCESSORIES

	Qty.	Part No.	Description
	1	AC/DC-6-3W	AC/DC Grounded Power adapter, 0°C to +40°C AC Input: 100-240 V, 50/60 Hz, I _{Max} = 1.2A DC Output 6±0.3 V, I _{Max} = 3A
	1	AC/DC-12-3W	AC/DC Grounded Power adapter, 0°C to +40°C AC Input: 100-240 V, 50/60 Hz, I _{Max} = 1.2A DC Output 12±0.6 V, I _{Max} = 3A
(Refer to power cord table)	2	CBL-3W-xx	AC power cord (IEC C13 connector to local plug) Select an option from the AC power cord list with each unit.
	1	CBL-0.5FT-MMD+	6.0 in. (15.0 cm) control cable for connecting the SSG to FX modules.
	1	MUSB-CBL-7FR+	6.6 ft (2.0 m) USB Cable: USB type A (Male) to USB type Mini-B (Male) with ferrite
	2	CBL-5FT-BMSMB+	5.0 ft (1.5 m) Trigger cable: BNC (male) to SMB (Female)

AC POWER CORD OPTIONS ²²

United States	Europe	United Kingdom	Australia and China	Israel
				
CBL-3W-US	CBL-3W-EU	CBL-3W-UK	CBL-3W-AU	CBL-3W-IL

22. Select one option from the list with each unit. Please contact testsolutions@minicircuits.com if your region is not listed.





USB & ETHERNET

Signal Generator

SSG-30GHP-RC

 Mini-Circuits

50Ω 0.01 to 30 GHz -38 dBm to +27 dBm 2.92 mm female

OPTIONAL ACCESSORIES

Part No.	Description
MUSB-CBL-3FR+	3.3 ft (1.0 m) USB Cable: USB type A (Male) to USB type Mini-B (Male) with ferrite
MUSB-CBL-7FR+ (spare)	6.6 ft (2.0 m) USB Cable: USB type A (Male) to USB type Mini-B (Male) with ferrite
CBL-RJ45-MM-5+	5.0 ft (1.5 m) network cable: RJ45 (Male) to RJ45 (Male) Cat 5E cable
CBL-5FT-BMSMB+ (spare)	5.0 ft (1.5 m) Trigger & Reference cable: BNC (male) to SMB (Female)

CALIBRATION

Part No.	Description
CALSSG-30GHP-RC	Calibration Service for SSG-30GHP-RC CLICK HERE

NOTES:

- Performance and quality attributes and conditions not expressly stated in this specification document are intended to be excluded and do not form a part of this specification document.
- Electrical specifications and performance data contained in this specification document are based on Mini-Circuit's applicable established test performance criteria and measurement instructions.
- The parts covered by this specification document are subject to Mini-Circuits standard limited warranty and terms and conditions (collectively, "Standard Terms"); Purchasers of this part are entitled to the rights and benefits contained therein. For a full statement of the Standard Terms and the exclusive rights and remedies thereunder, please visit Mini-Circuits' website at <https://www.minicircuits.com/terms/viewterm.html>



Typical Performance Data

Test Conditions: @ Temperature = 0°C.

Freq. (GHz)	Power deviation from nominal vs. Output Frequency (dB)									
	-30 dBm	-20 dBm	-10 dBm	0 dBm	+5 dBm	+10 dBm	+15 dBm	+20 dBm	+22 dBm	+25 dBm
0.05	0.60	0.33	0.82	0.94	1.12	0.87	0.66	0.22	0.23	-0.43
0.50	0.31	0.29	0.55	0.50	0.53	0.59	0.42	0.22	0.00	0.16
1.00	-0.23	-0.01	0.69	0.64	0.45	0.61	0.36	0.34	0.19	-0.23
2.00	0.61	0.54	0.56	0.72	0.69	0.98	0.67	0.37	0.81	0.25
3.00	1.02	-0.19	1.13	1.25	0.32	0.14	0.33	0.23	0.05	-0.16
4.00	0.23	-0.09	0.43	0.04	0.21	0.55	0.46	0.99	0.35	0.00
5.00	1.03	0.66	0.47	1.08	1.07	1.10	0.82	0.59	0.74	-0.07
6.00	-0.06	-0.04	0.14	0.13	-0.49	0.14	0.17	0.26	-0.01	0.01
7.00	-1.28	-0.21	-0.32	-0.79	0.37	0.37	0.27	0.91	0.75	0.36
8.00	0.47	0.03	0.18	0.29	0.43	0.39	0.52	1.10	0.93	0.54
9.00	-0.33	0.35	0.25	-0.37	0.38	0.41	0.43	0.36	0.10	-0.04
10.00	0.92	-0.28	0.18	0.22	0.07	0.02	0.19	-0.06	-0.11	-0.51
11.00	-0.94	0.06	-0.02	-0.09	-0.40	-0.33	-0.17	0.34	-0.08	-0.44
12.00	0.39	0.78	0.89	0.99	0.81	0.83	1.15	0.83	0.65	0.22
13.00	-0.73	-0.31	0.05	-0.42	-0.10	-0.14	0.25	0.21	0.21	-0.11
14.00	-0.44	-0.05	-0.03	0.01	-0.40	-0.11	-0.16	0.20	0.20	-0.34
15.00	-0.40	0.10	0.16	-0.40	-0.08	-0.18	0.32	-0.31	-0.29	-1.00
15.50	-0.34	0.06	-0.14	0.24	-0.23	-0.02	-0.21	0.24	0.21	-0.54
16.00	0.47	0.65	-0.15	-0.31	0.17	0.11	0.40	0.32	0.47	-0.08
16.50	0.80	0.60	-0.16	0.21	-0.13	-0.36	-0.07	0.30	0.44	-0.51
17.00	0.61	0.29	0.07	0.39	0.15	-0.07	0.21	0.67	0.27	-0.41
17.50	0.28	-0.01	0.00	0.26	0.08	-0.14	0.15	0.65	0.22	-0.59
18.00	-0.03	0.47	-0.03	0.23	-0.09	-0.13	0.17	0.13	0.17	-0.82
18.50	0.64	0.94	0.42	0.27	0.03	0.38	0.20	0.67	0.60	-0.75
19.00	-0.47	-0.08	0.14	-0.06	-0.16	0.21	-0.20	0.30	0.28	-0.72
19.50	0.23	0.09	-0.07	-0.34	-0.51	-0.14	0.18	0.04	0.13	-0.83
20.00	0.19	-0.23	-0.21	-0.42	-0.73	-0.36	-0.15	0.33	0.03	-0.73
20.50	1.05	0.88	0.61	0.44	0.35	0.27	0.43	0.78	0.38	-0.50
21.00	0.18	0.57	0.20	0.10	0.12	0.35	0.11	0.53	0.66	-0.47
21.50	-0.13	-0.31	-0.86	-0.45	-1.06	-0.77	-0.88	-0.67	-0.55	--
22.00	-0.46	-0.22	-0.64	-0.35	-0.71	-0.62	-0.45	-0.07	-0.52	--
22.50	0.38	0.21	0.12	-0.15	-0.34	-0.03	-0.43	0.06	0.28	--
23.00	0.48	0.34	0.18	0.01	-0.11	0.12	0.35	0.37	0.53	--
23.50	0.91	0.85	0.49	0.37	0.26	0.54	0.37	0.89	0.88	--
24.00	0.62	0.76	0.23	0.50	0.52	0.77	0.49	0.91	0.92	--
24.50	0.19	0.57	0.18	0.25	0.18	0.08	0.25	0.62	0.33	--
25.00	0.68	0.79	0.26	0.36	-0.04	0.34	0.44	0.40	0.57	--
25.50	-0.28	-0.04	-0.49	-0.29	-0.29	-0.21	-1.31	-0.92	-0.45	--
26.00	-0.18	-0.13	-0.13	-0.40	-0.20	-0.26	-1.13	-0.59	-0.15	--
26.50	-0.06	0.27	-0.27	-0.12	-0.24	-0.08	-1.26	-0.79	-0.60	--
27.00	0.43	0.56	0.02	0.33	0.29	-1.42	-0.80	-0.56	-0.32	--
27.50	-0.16	-0.45	-0.27	0.03	-0.03	-1.85	-1.35	-1.27	-0.95	--
28.00	-0.03	0.02	0.03	0.18	-0.03	-1.18	-0.99	-0.47	-1.04	--
28.50	0.04	-0.18	-0.14	0.38	0.31	-1.51	-1.29	-0.69	-0.60	--
29.00	0.66	0.51	0.51	0.91	0.93	-1.31	-0.77	-0.24	-0.28	--
30.00	1.63	1.07	1.48	1.53	0.63	-0.15	-0.02	0.14	-0.57	--

Typical Performance Data

Test Conditions: @ Temperature = 0°C.

Power (dBm)	Power deviation from nominal vs. Output Power (dBm)									
	0.05 GHz	1 GHz	5 GHz	10 GHz	15 GHz	18 GHz	21 GHz	25 GHz	27 GHz	30 GHz
-30	0.60	-0.23	1.03	0.92	-0.40	-0.03	0.18	0.68	0.43	1.63
-29	0.48	-0.10	0.91	1.13	-0.26	0.01	0.21	0.65	0.48	1.58
-28	0.36	0.03	0.80	1.33	-0.12	0.05	0.24	0.62	0.53	1.54
-27	0.40	0.04	0.76	1.29	-0.17	0.07	0.29	0.70	0.62	1.53
-26	0.45	0.04	0.71	1.24	-0.23	0.08	0.35	0.77	0.71	1.52
-25	0.32	-0.09	0.71	1.11	-0.17	0.13	0.39	0.69	0.49	1.59
-24	0.19	-0.22	0.71	0.98	-0.12	0.18	0.44	0.61	0.27	1.65
-23	0.59	-0.10	0.67	0.95	0.00	0.24	0.48	0.68	0.32	1.41
-22	0.98	0.02	0.62	0.92	0.12	0.29	0.52	0.74	0.37	1.16
-21	0.66	0.00	0.64	0.32	0.11	0.38	0.55	0.77	0.47	1.12
-20	0.33	-0.01	0.66	-0.28	0.10	0.47	0.57	0.79	0.56	1.07
-18	0.39	0.22	0.53	0.09	0.40	0.15	0.72	0.90	-0.19	1.31
-16	1.08	-0.08	0.47	0.17	-0.02	-0.16	0.29	0.20	-0.11	1.44
-14	0.63	0.36	0.47	0.02	0.07	-0.15	0.17	0.08	0.03	1.05
-12	0.99	0.76	0.51	0.09	0.06	-0.09	0.20	0.13	0.21	0.97
-10	0.82	0.69	0.47	0.18	0.16	-0.03	0.20	0.26	0.02	1.48
-8	0.78	0.67	0.33	0.01	-1.03	0.01	0.28	0.10	0.16	1.37
-6	1.07	0.66	0.79	0.12	0.03	0.11	-0.07	0.30	0.28	1.16
-4	1.03	0.66	0.44	-0.20	0.06	0.10	0.40	0.21	0.45	1.09
-2	0.93	0.55	0.68	-0.08	-0.23	0.22	0.11	0.44	0.27	1.66
0	0.94	0.64	1.08	0.22	-0.40	0.23	0.10	0.36	0.33	1.53
+1	1.11	0.55	1.19	0.16	-0.24	-0.21	0.12	0.40	0.35	1.48
+2	1.27	0.45	1.31	0.09	-0.08	-0.64	0.14	0.44	0.37	1.44
+3	1.22	0.47	1.11	0.09	-0.12	-0.23	0.11	0.16	0.44	1.51
+4	1.17	0.49	0.92	0.10	-0.17	0.19	0.08	-0.12	0.51	1.57
+5	1.12	0.45	1.07	0.07	-0.08	-0.09	0.12	-0.04	0.29	0.63
+6	1.07	0.41	1.23	0.03	0.01	-0.37	0.16	0.05	0.07	-0.32
+7	1.01	0.37	1.19	-0.01	-0.21	-0.30	0.22	0.10	0.11	-0.37
+8	0.95	0.32	1.15	-0.06	-0.42	-0.24	0.27	0.16	0.14	-0.42
+9	0.91	0.46	1.12	-0.02	-0.30	-0.18	0.31	0.25	-0.64	-0.28
+10	0.87	0.61	1.10	0.02	-0.18	-0.13	0.35	0.34	-1.42	-0.15
+11	0.79	0.57	1.03	-0.13	-0.23	-0.08	0.15	0.29	-1.29	-0.17
+12	0.72	0.54	0.97	-0.29	-0.27	-0.04	-0.04	0.25	-1.16	-0.18
+13	0.64	0.50	0.94	-0.21	0.07	0.03	0.00	0.34	-1.05	-0.11
+14	0.56	0.45	0.91	-0.12	0.42	0.10	0.05	0.43	-0.95	-0.04
+15	0.66	0.36	0.82	0.19	0.32	0.17	0.11	0.44	-0.80	-0.02
+16	0.76	0.26	0.73	0.50	0.23	0.23	0.17	0.45	-0.65	0.01
+17	0.58	0.23	0.73	0.13	-0.02	0.08	0.27	0.61	-0.63	0.17
+18	0.41	0.20	0.73	-0.23	-0.27	-0.07	0.36	0.77	-0.61	0.32
+19	0.31	0.27	0.66	-0.15	-0.29	0.03	0.45	0.58	-0.59	0.23
+20	0.22	0.34	0.59	-0.06	-0.31	0.13	0.53	0.40	-0.56	0.14
+21	0.22	0.27	0.66	-0.09	-0.30	0.15	0.60	0.48	-0.44	-0.21
+22	0.23	0.19	0.74	-0.11	-0.29	0.17	0.66	0.57	-0.32	-0.57
+23	0.04	-0.01	0.42	-0.31	-0.38	-0.04	0.32	0.31	--	--
+24	-0.15	-0.21	0.11	-0.51	-0.47	-0.25	-0.02	0.06	--	--
+25	-0.43	-0.23	-0.07	-0.51	-1.00	-0.82	-0.47	--	--	--

Typical Performance Data

Test Conditions: @ Temperature = 0°C.

Freq. (GHz)	Harmonics levels vs. Output Frequency (dBc)									
	-20 dBm					+10 dBm				
	F2	F3	F0.5	F1.5	F2.5	F2	F3	F0.5	F1.5	F2.5
0.05	-44.77	-7.41	--	--	--	-39.00	-11.35	--	--	--
0.50	-30.04	-8.66	--	--	--	-31.97	-8.39	--	--	--
1.00	-19.43	-8.39	--	--	--	-16.23	-7.28	--	--	--
2.00	-20.97	-40.61	--	--	--	-22.24	-44.10	--	--	--
3.00	-46.30	-46.47	--	--	--	-37.78	-69.41	--	--	--
4.00	-40.22	-49.09	--	--	--	-38.40	-65.81	--	--	--
5.00	-40.66	-48.75	--	--	--	-38.65	-67.49	--	--	--
6.00	-20.92	-44.30	--	--	--	-25.83	-49.43	--	--	--
7.00	-14.96	-41.35	--	--	--	-15.41	-50.51	--	--	--
8.00	-29.22	-39.44	--	--	--	-27.89	-58.79	--	--	--
9.00	-34.84	-42.27	--	--	--	-41.04	-66.53	--	--	--
10.00	-40.99	-40.33	--	--	--	-43.10	-65.41	--	--	--
11.00	-41.50	-42.76	--	--	--	-41.81	-61.41	--	--	--
12.00	-44.00	-43.39	--	--	--	-37.48	-66.48	--	--	--
13.00	-41.07	-37.08	--	--	--	-37.72	-62.85	--	--	--
14.00	-42.35	-37.43	--	--	--	-34.67	-60.66	--	--	--
15.00	-43.12	-35.54	-49.57	-47.56	-37.23	-36.12	-59.98	-69.53	-75.06	-69.68
15.50	-42.50	-34.56	-41.94	-32.87	-33.65	-34.13	-57.26	-71.51	-63.09	-66.46
16.00	-41.18	-35.60	-35.33	-44.63	-36.90	-30.75	-57.52	-66.87	-71.26	-66.14
16.50	-40.43	-33.86	-41.95	-41.29	-36.57	-33.03	-60.37	-72.64	-73.41	-67.53
17.00	-33.49	-48.47	-43.75	-43.41	-37.73	-31.50	-62.83	-77.30	-74.00	-65.76
17.50	-35.22	-41.52	-25.54	-44.67	-36.79	-36.89	-64.46	-56.60	-73.56	-69.45
18.00	-38.22	-44.92	-40.35	-43.47	-38.58	-43.16	-66.85	-68.85	-73.04	-66.50
18.50	-38.02	-50.25	-28.98	-45.91	-36.77	-51.82	-68.03	-59.08	-75.34	-65.43
19.00	-38.29	-51.05	-33.48	-37.74	-33.29	-42.17	-70.48	-62.31	-69.35	-68.00
19.50	-38.59	-54.36	-43.17	-43.95	-33.43	-36.61	-67.88	-69.02	-71.90	-62.06
20.00	-38.71	-54.13	-39.03	-41.32	-36.91	-36.17	-63.03	-65.85	-69.45	-65.11
20.50	-35.20	-53.76	-40.18	-41.26	-52.76	-36.01	-62.70	-65.16	-71.18	-68.21
21.00	-37.75	-51.02	-38.93	-42.60	-54.57	-38.11	-61.81	-58.19	-69.80	-68.20
21.50	-35.74	-51.05	-35.69	-43.08	-53.37	-39.83	-63.50	-59.80	-69.90	-67.07
22.00	-34.80	-53.26	-42.10	-42.00	-52.16	-38.33	-62.45	-64.46	-70.43	-68.53
22.50	-35.34	-53.28	-41.10	-43.39	-53.47	-37.80	-67.90	-67.05	-70.64	-68.58
23.00	-32.49	-53.35	-33.03	-39.95	-55.55	-38.26	-66.58	-66.08	-67.72	-67.33
23.50	-30.49	-52.09	-27.05	-41.86	-56.29	-39.65	-65.35	-50.01	-71.47	-70.56
24.00	-30.30	-51.15	-31.16	-39.40	-55.72	-44.21	-68.25	-50.95	-70.36	-68.26
24.50	-30.93	-45.07	-27.68	-38.56	-52.78	-44.60	-67.21	-54.42	-69.94	-70.95
25.00	-30.94	-43.10	-23.17	-39.39	-51.30	-41.64	-62.39	-59.24	-69.07	-72.07
25.50	-39.30	-48.60	-29.22	-38.25	-55.30	-44.85	-61.11	-61.76	-69.93	-67.31
26.00	-36.39	-51.38	-26.51	-37.47	-53.90	-46.02	-62.81	-53.66	-69.25	-70.06
26.50	-34.28	-48.82	-28.81	-38.61	-55.49	-46.61	-63.88	-52.61	-68.57	-69.82
27.00	-38.58	-49.14	-28.53	-37.53	-55.48	-52.24	-63.74	-55.30	-65.93	-67.70
27.50	-39.31	-50.67	-32.94	-39.52	-53.87	-51.26	-65.42	-56.99	-64.68	-64.05
28.00	-53.35	-52.43	-31.84	-35.23	-54.07	-52.77	-66.01	-54.93	-64.99	-63.72
28.50	-49.21	-49.79	-28.25	-34.91	-53.02	-51.32	-63.75	-52.81	-67.18	-64.18
29.00	-54.28	-52.87	-28.36	-39.13	-49.42	-52.59	-67.74	-56.03	-65.74	-64.47
30.00	-56.91	-54.49	-28.43	-38.92	-49.50	-47.25	-63.80	-57.63	-66.14	-65.49

Note: No sub-harmonics below 15 GHz.

Typical Performance Data

Test Conditions: @ Temperature = 0°C.

Freq. (GHz)	Harmonics levels vs. Output Frequency (dBc)				
	+20 dBm				
	F2	F3	F0.5	F1.5	F2.5
0.05	-38.82	-11.44	--	--	--
0.50	-34.70	-8.32	--	--	--
1.00	-16.70	-7.21	--	--	--
2.00	-18.88	-37.21	--	--	--
3.00	-26.29	-49.23	--	--	--
4.00	-24.08	-29.14	--	--	--
5.00	-26.81	-43.75	--	--	--
6.00	-25.34	-40.19	--	--	--
7.00	-22.78	-37.15	--	--	--
8.00	-21.93	-35.67	--	--	--
9.00	-28.62	-41.34	--	--	--
10.00	-35.70	-55.92	--	--	--
11.00	-28.93	-39.42	--	--	--
12.00	-23.72	-45.26	--	--	--
13.00	-24.94	-42.32	--	--	--
14.00	-23.11	-42.06	--	--	--
15.00	-23.48	-38.26	-75.47	-85.64	-79.34
15.50	-18.70	-35.41	-81.71	-72.16	-78.49
16.00	-16.44	-33.78	-76.92	-76.76	-76.68
16.50	-18.60	-36.43	-83.28	-85.63	-77.83
17.00	-16.85	-39.65	-87.67	-81.51	-78.58
17.50	-22.92	-41.29	-68.18	-80.80	-78.66
18.00	-30.50	-47.19	-79.35	-81.36	-79.81
18.50	-40.82	-46.37	-69.38	-83.95	-77.80
19.00	-28.64	-47.94	-72.62	-81.31	-73.73
19.50	-22.58	-45.55	-73.86	-77.51	-73.61
20.00	-22.71	-45.11	-64.87	-69.47	-74.49
20.50	-22.85	-43.85	-60.65	-67.27	-74.41
21.00	-25.23	-37.17	-58.90	-67.14	-77.13
21.50	-27.11	-38.69	-65.26	-76.03	-76.64
22.00	-24.43	-38.31	-64.31	-71.33	-77.93
22.50	-24.55	-42.75	-65.76	-72.68	-79.32
23.00	-24.28	-45.73	-60.46	-68.90	-78.88
23.50	-25.17	-45.36	-54.67	-72.05	-79.75
24.00	-26.78	-49.12	-53.16	-71.57	-80.70
24.50	-26.70	-52.71	-56.71	-77.95	-80.36
25.00	-26.62	-56.24	-65.89	-74.93	-78.32
25.50	-33.30	-53.34	-68.32	-74.43	-77.20
26.00	-32.88	-53.62	-80.71	-77.83	-76.33
26.50	-34.88	-54.24	-61.64	-73.69	-75.60
27.00	-39.19	-56.08	-59.31	-72.86	-76.98
27.50	-37.71	-59.43	-58.07	-71.36	-78.39
28.00	-39.80	-61.69	-57.26	-71.15	-76.34
28.50	-40.11	-61.79	-55.85	-74.05	-75.31
29.00	-38.80	-68.55	-56.42	-69.59	-75.97
30.00	-34.33	-56.25	-65.15	-75.38	-72.27

Note: No sub-harmonics below 15 GHz.

Typical Performance Data

Test Conditions: @ Temperature = 0°C.

Freq. (GHz)	Phase Noise vs. Output Freq. at Frequency Offsets (dBc / Hz)					
	100 Hz	1 kHz	10 kHz	100 kHz	1 MHz	10 MHz
0.05	-119.04	-129.03	-131.44	-130.41	-133.19	-129.82
0.50	-98.09	-118.65	-122.62	-122.51	-131.61	-128.68
1.00	-93.57	-113.11	-118.45	-117.50	-129.74	-128.00
2.00	-90.72	-106.59	-113.62	-111.21	-130.33	-126.34
3.00	-83.15	-102.72	-109.29	-108.50	-125.41	-122.59
4.00	-80.15	-100.65	-106.05	-104.91	-122.34	-122.08
5.00	-81.73	-98.96	-104.64	-102.98	-119.61	-119.89
6.00	-78.21	-96.83	-102.42	-101.11	-124.16	-120.78
7.00	-75.40	-95.03	-100.50	-100.78	-121.10	-123.59
8.00	-74.99	-93.55	-101.36	-100.35	-121.36	-120.35
9.00	-73.87	-93.04	-99.84	-98.22	-122.41	-121.06
10.00	-75.00	-92.37	-99.12	-97.08	-120.97	-120.19
11.00	-75.98	-90.76	-98.42	-96.35	-122.08	-121.50
12.00	-70.86	-90.90	-95.12	-95.87	-121.58	-121.93
13.00	-70.60	-89.90	-96.75	-96.40	-117.90	-122.19
14.00	-69.83	-89.03	-95.97	-94.12	-115.72	-117.24
15.00	-66.83	-87.94	-96.39	-94.27	-114.87	-118.64
15.50	-68.24	-88.30	-95.88	-93.82	-119.55	-121.62
16.00	-68.70	-88.73	-94.88	-93.18	-117.76	-117.49
16.50	-67.04	-87.77	-94.74	-94.04	-121.00	-122.35
17.00	-69.07	-88.19	-94.38	-92.97	-114.67	-120.37
17.50	-69.01	-87.81	-94.21	-93.53	-121.60	-116.04
18.00	-67.40	-88.14	-94.14	-92.85	-119.12	-115.64
18.50	-65.96	-87.90	-94.40	-92.65	-119.50	-115.18
19.00	-66.23	-86.97	-94.15	-91.99	-118.68	-115.44
19.50	-66.05	-87.28	-92.95	-92.01	-117.48	-114.33
20.00	-67.54	-87.43	-94.84	-91.56	-112.96	-112.86
20.50	-65.64	-87.00	-93.06	-91.25	-119.32	-115.00
21.00	-67.74	-85.93	-93.00	-92.34	-114.42	-116.36
21.50	-65.82	-86.68	-93.99	-91.25	-116.06	-114.99
22.00	-64.64	-86.17	-92.32	-90.32	-113.00	-115.67
22.50	-68.04	-85.81	-90.23	-91.15	-113.70	-113.90
23.00	-63.36	-84.66	-89.91	-89.33	-113.40	-115.07
23.50	-64.11	-84.36	-92.27	-90.40	-115.96	-115.82
24.00	-64.73	-84.60	-92.87	-90.41	-112.49	-114.72
24.50	-61.31	-85.25	-91.73	-89.64	-112.35	-111.98
25.00	-64.51	-84.62	-90.76	-88.68	-113.48	-114.63
25.50	-61.76	-83.25	-89.65	-88.81	-111.96	-114.41
26.00	-65.94	-82.88	-90.23	-89.86	-111.20	-110.84
26.50	-64.35	-84.10	-91.22	-89.01	-106.82	-111.04
27.00	-62.53	-83.43	-89.95	-88.93	-111.18	-111.72
27.50	-59.33	-83.51	-88.42	-88.18	-110.21	-110.45
28.00	-68.52	-83.51	-91.27	-88.23	-108.51	-110.87
28.50	-67.12	-83.79	-90.67	-87.04	-107.76	-111.71
29.00	-65.28	-83.71	-89.06	-87.53	-109.47	-111.68
30.00	-64.43	-83.00	-88.66	-89.00	-108.20	-111.41

Typical Performance Data

Test Conditions: @ Temperature = 0°C.

Freq. Offsets (kHz)	Phase Noise vs. Offset Freq. at Frequency Output (dBc / Hz)					
	0.05 GHz	1 GHz	5 GHz	10 GHz	20 GHz	30 GHz
0.1	-119.04	-93.57	-81.73	-75.00	-67.54	-64.43
1	-129.03	-113.11	-98.96	-92.37	-87.43	-83.00
10	-131.44	-118.45	-104.64	-99.12	-94.84	-88.66
100	-130.41	-117.50	-102.98	-97.08	-91.56	-89.00
1000	-133.19	-129.74	-119.61	-120.97	-112.96	-108.20
10000	-129.82	-128.00	-119.89	-120.19	-112.86	-111.41

Freq. (GHz)	Spurious (dBc)
0.05	-73.93
0.50	-80.28
1.00	-76.55
2.00	-76.95
3.00	-66.66
4.00	-72.93
5.00	-71.58
6.00	-66.99
7.00	-65.45
8.00	-63.61
9.00	-61.80
10.00	-64.71
11.00	-61.28
12.00	-58.79
13.00	-59.74
14.00	-53.57
15.00	-53.04
15.50	-58.92
16.00	-55.84
16.50	-57.29
17.00	-60.31
17.50	-57.38
18.00	-56.83
18.50	-54.07
19.00	-56.13
19.50	-57.05
20.00	-55.20
20.50	-53.32
21.00	-56.91
21.50	-57.11
22.00	-51.28
22.50	-52.32
23.00	-51.46
23.50	-55.57
24.00	-52.52
24.50	-48.64
25.00	-52.11
25.50	-50.42
26.00	-55.45
26.50	-50.12
27.00	-49.05
27.50	-48.86
28.00	-48.15
28.50	-45.53
29.00	-49.80
30.00	-45.39

Typical Performance Data

Test Conditions: @ Temperature = 25°C.

Freq. (GHz)	Power deviation from nominal vs. Output Frequency (dB)									
	-30 dBm	-20 dBm	-10 dBm	0 dBm	+5 dBm	+10 dBm	+15 dBm	+20 dBm	+22 dBm	+25 dBm
0.05	0.98	0.54	1.32	0.95	0.87	1.08	0.74	0.38	0.05	-0.64
0.50	0.72	0.45	0.58	0.55	0.64	0.65	0.49	0.25	0.15	0.14
1.00	-0.14	0.12	0.69	0.46	0.74	0.68	0.62	0.47	0.28	-0.28
2.00	0.98	1.11	1.23	0.63	0.93	0.84	0.68	0.96	0.64	0.30
3.00	0.46	0.33	0.67	0.59	0.62	0.46	0.31	0.18	0.59	-0.11
4.00	0.53	0.48	0.53	0.54	0.91	0.70	0.70	0.54	0.15	-0.01
5.00	0.16	-0.43	-0.33	-0.56	-0.20	-0.07	0.60	0.21	-0.71	-1.00
6.00	-0.13	0.45	0.22	0.39	0.04	0.09	0.26	0.23	0.10	-0.27
7.00	-0.18	-0.26	-0.06	-0.02	0.39	0.16	-0.04	-0.33	0.00	-0.45
8.00	0.87	0.53	0.35	0.32	0.45	0.62	0.61	0.23	0.04	-0.14
9.00	-0.22	0.23	0.36	0.12	0.37	0.32	0.14	0.01	-0.22	-0.46
10.00	0.81	0.08	-0.03	0.10	0.21	0.11	0.15	0.22	-0.04	-0.65
11.00	-0.76	-0.24	0.02	-0.73	-0.48	-0.53	-0.62	-0.08	-0.69	-1.01
12.00	0.52	0.38	0.76	0.64	0.48	0.66	0.52	0.03	0.16	-0.59
13.00	0.08	-0.01	0.07	0.14	0.01	0.18	-0.06	-0.15	-0.27	-0.58
14.00	-0.07	0.26	0.07	-0.01	0.00	-0.38	-0.06	-0.15	-0.33	-0.88
15.00	0.58	0.21	0.26	0.41	0.25	0.33	-0.29	-0.20	-0.48	-1.53
15.50	-0.42	-0.47	-0.25	-0.08	-0.54	-0.38	-0.13	-0.31	-0.37	-1.04
16.00	-0.11	-0.14	-0.21	-0.18	-0.12	-0.32	-0.09	-0.21	-0.11	-0.59
16.50	0.16	-0.74	-0.24	-0.87	-0.40	-0.24	-0.48	-0.13	-0.58	-0.69
17.00	0.02	-0.38	-0.32	-0.41	0.01	0.17	-0.07	0.30	-0.15	-0.47
17.50	-0.13	-0.12	0.13	-0.27	-0.01	-0.24	0.02	0.30	-0.27	-0.67
18.00	-0.07	0.09	-0.31	-0.10	-0.46	-0.25	0.03	-0.07	-0.15	-0.82
18.50	-0.10	-0.12	-0.35	-0.15	-0.04	-0.34	-0.03	0.34	0.19	-0.75
19.00	-1.05	-0.51	-0.47	-0.73	-0.39	-0.23	-0.57	-0.22	-0.25	-0.89
19.50	0.33	-0.07	-0.46	-0.74	-0.49	-0.27	0.11	-0.14	-0.19	-0.91
20.00	-0.29	-0.17	-0.21	-0.62	-0.53	-0.33	-0.14	-0.17	-0.19	-0.62
20.50	0.59	0.28	0.32	-0.17	0.41	0.09	0.24	0.19	-0.06	-0.55
21.00	0.01	0.15	0.12	-0.40	0.12	-0.23	0.06	0.47	-0.09	-0.56
21.50	-0.04	-0.58	-0.33	-0.70	-0.82	-0.70	-0.37	-0.70	-0.64	--
22.00	-0.20	-0.43	-0.54	-0.53	-0.16	-0.57	-0.25	-0.56	-0.53	--
22.50	-0.26	-0.23	-0.05	0.20	-0.28	-0.15	0.08	0.10	-0.11	--
23.00	-0.12	-0.15	0.03	0.24	0.17	-0.13	0.10	0.22	0.01	--
23.50	0.61	0.35	0.42	-0.10	0.08	0.24	0.58	0.64	0.47	--
24.00	0.54	0.06	0.06	0.03	0.36	0.59	0.35	0.76	0.12	--
24.50	0.25	-0.18	-0.10	0.19	0.13	-0.23	0.22	0.64	0.01	--
25.00	0.48	0.47	-0.20	0.06	-0.09	-0.23	0.07	0.12	-0.16	--
25.50	-0.05	-0.10	-0.26	0.08	0.00	-0.78	-0.35	-0.18	-0.10	--
26.00	0.11	0.18	-0.02	0.27	0.31	-0.63	-0.64	0.13	-0.10	--
26.50	-0.06	-0.03	-0.76	-0.46	-0.32	-0.97	-0.54	-0.51	-0.51	--
27.00	0.72	-0.12	0.33	0.21	0.25	-0.34	-0.27	0.24	-0.18	--
27.50	0.05	0.12	0.27	0.34	0.10	-0.99	-1.01	-0.80	-0.60	--
28.00	-0.04	0.11	0.10	-0.22	-0.28	-0.69	-0.71	-0.48	-0.44	--
28.50	0.25	0.14	-0.09	0.06	-0.18	-0.47	-0.56	-0.67	-0.69	--
29.00	0.14	0.14	0.48	0.71	-0.18	-0.23	-0.34	-0.34	-0.33	--
30.00	0.98	0.78	0.42	0.56	0.02	0.16	-0.06	-0.10	-0.24	--

Typical Performance Data

Test Conditions: @ Temperature = 25°C.

Power (dBm)	Power deviation from nominal vs. Output Power (dBm)									
	0.05 GHz	1 GHz	5 GHz	10 GHz	15 GHz	18 GHz	21 GHz	25 GHz	27 GHz	30 GHz
-30	0.98	-0.14	0.16	0.81	0.58	-0.07	0.01	0.48	0.72	0.98
-29	0.81	-0.01	0.03	1.02	0.49	-0.04	0.05	0.55	0.76	0.98
-28	0.65	0.12	-0.10	1.23	0.39	-0.02	0.08	0.63	0.79	0.97
-27	0.72	0.10	-0.31	1.13	0.30	-0.07	0.05	0.46	0.46	0.90
-26	0.79	0.07	-0.52	1.03	0.20	-0.12	0.01	0.30	0.13	0.82
-25	0.85	-0.03	-0.30	0.97	0.33	-0.11	0.05	0.37	0.20	0.79
-24	0.92	-0.13	-0.07	0.91	0.45	-0.11	0.09	0.44	0.27	0.76
-23	0.98	0.13	-0.09	0.63	0.34	-0.06	0.10	0.41	0.32	0.63
-22	1.04	0.39	-0.11	0.35	0.23	0.00	0.12	0.38	0.37	0.50
-21	0.79	0.26	-0.27	0.21	0.22	0.04	0.14	0.42	0.12	0.64
-20	0.54	0.12	-0.43	0.08	0.21	0.09	0.15	0.47	-0.12	0.78
-18	0.40	0.19	-0.54	0.01	0.27	-0.08	-0.27	-0.02	-0.04	0.52
-16	0.97	-0.05	-0.20	0.24	0.56	0.14	0.17	0.12	0.26	0.69
-14	0.67	0.70	-0.45	0.09	0.17	-0.31	0.09	-0.08	0.52	0.51
-12	0.78	0.76	-0.26	0.17	0.30	-0.23	0.24	0.11	0.39	0.71
-10	1.32	0.69	-0.33	-0.03	0.26	-0.31	0.12	-0.20	0.33	0.42
-8	1.12	0.52	-0.26	0.04	0.44	-0.24	0.20	-0.03	-0.03	0.58
-6	0.83	0.54	-0.05	-0.08	0.12	-0.22	0.23	-0.14	0.14	0.50
-4	1.04	0.52	-0.32	0.27	0.20	-0.12	0.27	-0.01	-0.07	0.65
-2	0.99	0.35	-0.15	0.11	0.00	-0.14	0.27	-0.04	0.14	0.59
0	0.95	0.46	-0.56	0.10	0.41	-0.10	-0.40	0.06	0.21	0.56
+1	0.93	0.60	-0.45	-0.01	0.14	0.01	-0.13	0.04	0.30	0.62
+2	0.92	0.73	-0.34	-0.11	-0.14	0.11	0.13	0.02	0.40	0.69
+3	0.93	0.66	-0.31	-0.04	-0.01	-0.19	0.12	0.08	0.32	0.38
+4	0.93	0.59	-0.27	0.02	0.12	-0.50	0.11	0.14	0.24	0.07
+5	0.87	0.74	-0.20	0.21	0.25	-0.46	0.12	-0.09	0.25	0.02
+6	0.81	0.89	-0.12	0.39	0.38	-0.42	0.14	-0.33	0.26	-0.04
+7	0.76	0.80	-0.04	0.40	0.40	-0.37	0.19	-0.22	-0.12	0.10
+8	0.71	0.71	0.04	0.40	0.41	-0.32	0.25	-0.12	-0.50	0.25
+9	0.89	0.70	-0.02	0.25	0.37	-0.29	0.01	-0.17	-0.42	0.20
+10	1.08	0.68	-0.07	0.11	0.33	-0.25	-0.23	-0.23	-0.34	0.16
+11	0.96	0.58	-0.17	0.11	0.23	-0.22	-0.19	-0.09	-0.41	-0.02
+12	0.85	0.48	-0.28	0.12	0.13	-0.19	-0.16	0.04	-0.48	-0.19
+13	0.85	0.50	0.20	0.27	-0.08	-0.11	-0.09	0.01	-0.36	-0.20
+14	0.84	0.52	0.68	0.43	-0.28	-0.03	-0.01	-0.03	-0.24	-0.21
+15	0.74	0.62	0.60	0.15	-0.29	0.03	0.06	0.07	-0.27	-0.06
+16	0.64	0.71	0.52	-0.13	-0.30	0.09	0.13	0.16	-0.31	0.09
+17	0.73	0.69	0.48	-0.09	-0.34	-0.08	0.16	0.19	-0.12	0.10
+18	0.81	0.67	0.43	-0.06	-0.38	-0.25	0.18	0.22	0.06	0.10
+19	0.59	0.57	0.32	0.08	-0.29	-0.16	0.32	0.17	0.15	0.00
+20	0.38	0.47	0.21	0.22	-0.20	-0.07	0.47	0.12	0.24	-0.10
+21	0.21	0.38	-0.25	0.09	-0.34	-0.11	0.19	-0.02	0.03	-0.17
+22	0.05	0.28	-0.71	-0.04	-0.48	-0.15	-0.09	-0.16	-0.18	-0.24
+23	-0.14	0.01	-0.77	-0.26	-0.74	-0.37	-0.20	-0.30	--	--
+24	-0.34	-0.25	-0.84	-0.48	-1.01	-0.58	-0.31	-0.43	--	--
+25	-0.64	-0.28	-1.00	-0.65	-1.53	-0.82	-0.56	--	--	--

Typical Performance Data

Test Conditions: @ Temperature = 25°C.

Freq. (GHz)	Harmonics levels vs. Output Frequency (dBc)									
	-20 dBm					+10 dBm				
	F2	F3	F0.5	F1.5	F2.5	F2	F3	F0.5	F1.5	F2.5
0.05	-45.95	-7.29	--	--	--	-40.24	-11.11	--	--	--
0.50	-29.11	-7.98	--	--	--	-30.27	-8.54	--	--	--
1.00	-18.51	-8.69	--	--	--	-16.03	-7.56	--	--	--
2.00	-21.04	-42.69	--	--	--	-21.75	-44.55	--	--	--
3.00	-48.65	-47.70	--	--	--	-37.28	-69.13	--	--	--
4.00	-40.23	-49.52	--	--	--	-38.34	-63.84	--	--	--
5.00	-40.75	-48.20	--	--	--	-40.09	-65.99	--	--	--
6.00	-19.78	-44.57	--	--	--	-24.93	-51.32	--	--	--
7.00	-17.00	-44.69	--	--	--	-18.23	-52.15	--	--	--
8.00	-31.62	-41.64	--	--	--	-30.10	-58.78	--	--	--
9.00	-34.16	-45.67	--	--	--	-41.99	-64.91	--	--	--
10.00	-42.17	-43.77	--	--	--	-42.93	-67.23	--	--	--
11.00	-41.51	-42.91	--	--	--	-40.92	-61.32	--	--	--
12.00	-43.78	-39.42	--	--	--	-38.55	-67.78	--	--	--
13.00	-44.02	-36.66	--	--	--	-37.30	-63.34	--	--	--
14.00	-42.63	-39.93	--	--	--	-35.10	-61.35	--	--	--
15.00	-40.35	-34.33	-51.39	-45.84	-36.16	-35.88	-60.01	-69.03	-76.48	-68.62
15.50	-44.87	-37.10	-41.54	-35.63	-34.80	-33.37	-57.64	-72.16	-64.24	-66.94
16.00	-42.19	-36.66	-35.32	-43.64	-37.48	-31.33	-56.90	-65.64	-71.87	-66.65
16.50	-43.07	-34.02	-41.63	-43.54	-35.71	-33.73	-60.31	-72.20	-72.12	-67.75
17.00	-42.73	-51.01	-44.05	-41.59	-37.58	-32.32	-64.16	-76.74	-73.34	-69.56
17.50	-40.81	-53.05	-26.32	-44.01	-36.48	-39.23	-61.73	-55.94	-71.82	-68.39
18.00	-37.31	-48.25	-36.57	-41.23	-35.36	-47.60	-66.46	-66.04	-70.44	-68.80
18.50	-38.52	-50.33	-27.53	-43.00	-37.76	-48.45	-65.43	-57.03	-72.97	-66.43
19.00	-38.28	-51.76	-32.94	-39.47	-33.89	-38.67	-65.60	-61.91	-69.18	-62.62
19.50	-37.69	-52.96	-42.46	-42.55	-35.04	-35.38	-65.53	-66.19	-72.21	-63.83
20.00	-34.54	-56.44	-38.11	-43.44	-36.05	-36.14	-65.08	-68.52	-69.47	-64.76
20.50	-33.92	-53.32	-37.02	-44.54	-52.79	-36.65	-64.21	-66.13	-69.73	-68.21
21.00	-37.78	-49.96	-36.64	-45.18	-51.72	-38.54	-62.47	-56.48	-69.52	-67.06
21.50	-37.20	-49.45	-34.33	-41.40	-55.28	-39.22	-61.41	-57.89	-68.73	-65.28
22.00	-34.07	-54.46	-41.98	-42.65	-53.82	-37.75	-62.56	-62.51	-71.49	-68.24
22.50	-32.98	-53.65	-38.53	-43.50	-52.81	-37.33	-66.02	-63.99	-71.94	-69.79
23.00	-36.62	-52.72	-32.01	-43.17	-57.09	-38.48	-63.87	-63.99	-71.10	-69.95
23.50	-33.21	-48.66	-24.76	-38.77	-53.96	-38.69	-65.40	-50.16	-68.47	-67.95
24.00	-32.93	-47.94	-29.91	-36.37	-59.56	-42.00	-66.28	-50.49	-70.19	-70.98
24.50	-31.71	-47.11	-25.94	-39.16	-55.23	-43.53	-66.42	-57.10	-68.57	-68.79
25.00	-29.94	-45.26	-20.71	-37.80	-53.24	-42.52	-62.04	-53.94	-67.21	-67.66
25.50	-38.47	-46.22	-28.11	-38.76	-53.46	-45.00	-61.47	-58.39	-66.28	-67.93
26.00	-36.68	-50.86	-25.42	-35.51	-54.27	-45.71	-63.22	-56.81	-66.31	-68.21
26.50	-35.15	-47.31	-26.90	-40.88	-54.28	-46.98	-64.03	-54.23	-68.73	-69.60
27.00	-52.37	-52.89	-26.14	-38.50	-53.72	-49.96	-62.77	-53.81	-68.20	-69.01
27.50	-53.85	-51.60	-31.66	-37.52	-55.16	-49.45	-65.35	-55.78	-64.48	-69.66
28.00	-51.86	-50.63	-32.13	-37.59	-55.26	-50.43	-63.37	-55.06	-64.83	-67.25
28.50	-50.47	-52.00	-28.79	-37.55	-52.40	-50.35	-65.97	-53.45	-68.79	-68.94
29.00	-52.21	-52.11	-28.13	-37.40	-50.27	-51.22	-66.76	-57.75	-68.29	-66.48
30.00	-57.75	-53.15	-26.69	-38.93	-50.24	-46.00	-65.14	-54.59	-67.18	-66.05

Note: No sub-harmonics below 15 GHz.

Typical Performance Data

Test Conditions: @ Temperature = 25°C.

Freq. (GHz)	Harmonics levels vs. Output Frequency (dBc)				
	+20 dBm				
	F2	F3	F0.5	F1.5	F2.5
0.05	-47.46	-11.13	--	--	--
0.50	-32.98	-8.42	--	--	--
1.00	-15.94	-7.49	--	--	--
2.00	-19.03	-38.08	--	--	--
3.00	-25.91	-47.02	--	--	--
4.00	-24.90	-29.96	--	--	--
5.00	-28.69	-45.69	--	--	--
6.00	-27.18	-40.36	--	--	--
7.00	-25.33	-42.29	--	--	--
8.00	-25.09	-40.66	--	--	--
9.00	-29.52	-42.19	--	--	--
10.00	-45.33	-50.99	--	--	--
11.00	-29.17	-40.72	--	--	--
12.00	-26.48	-54.38	--	--	--
13.00	-25.42	-42.09	--	--	--
14.00	-23.41	-42.39	--	--	--
15.00	-24.20	-38.95	-72.58	-81.56	-77.39
15.50	-19.23	-34.46	-80.65	-76.70	-76.85
16.00	-17.80	-35.79	-75.03	-80.93	-77.28
16.50	-19.90	-38.35	-81.54	-84.22	-76.56
17.00	-18.94	-40.56	-87.96	-82.55	-77.87
17.50	-26.59	-41.78	-67.81	-78.07	-76.45
18.00	-36.14	-45.04	-77.46	-79.58	-75.77
18.50	-34.87	-45.55	-67.28	-79.13	-79.06
19.00	-26.37	-47.70	-71.72	-80.75	-78.77
19.50	-23.10	-45.66	-71.95	-77.63	-71.90
20.00	-23.89	-44.98	-66.60	-73.07	-76.33
20.50	-24.50	-43.51	-59.90	-67.74	-75.28
21.00	-25.77	-36.70	-57.14	-66.78	-77.50
21.50	-27.10	-37.96	-62.07	-73.15	-77.44
22.00	-25.49	-38.21	-62.34	-72.46	-78.50
22.50	-24.46	-42.66	-63.13	-72.48	-78.36
23.00	-24.59	-46.51	-60.31	-70.67	-76.35
23.50	-24.89	-45.38	-56.12	-75.23	-79.08
24.00	-26.97	-49.01	-52.82	-75.89	-78.99
24.50	-27.28	-53.07	-58.12	-79.11	-79.04
25.00	-29.29	-57.67	-63.32	-74.25	-79.27
25.50	-31.28	-52.43	-72.43	-77.31	-79.04
26.00	-31.23	-55.68	-70.78	-76.33	-77.08
26.50	-33.11	-55.21	-60.33	-71.70	-76.59
27.00	-36.01	-58.87	-57.92	-71.95	-81.31
27.50	-35.74	-59.10	-57.19	-70.22	-77.99
28.00	-37.32	-61.09	-56.19	-69.71	-75.33
28.50	-38.01	-59.37	-55.68	-69.69	-77.03
29.00	-38.85	-68.81	-56.33	-69.73	-77.71
30.00	-33.10	-55.50	-60.17	-73.61	-75.67

Note: No sub-harmonics below 15 GHz.

Typical Performance Data

Test Conditions: @ Temperature = 25°C.

Freq. (GHz)	Phase Noise vs. Output Freq. at Frequency Offsets (dBc / Hz)					
	100 Hz	1 kHz	10 kHz	100 kHz	1 MHz	10 MHz
0.05	-114.66	-128.12	-132.04	-129.77	-132.09	-127.43
0.50	-97.09	-115.87	-123.21	-122.50	-129.16	-127.11
1.00	-92.96	-111.16	-118.74	-117.44	-127.88	-126.91
2.00	-83.43	-104.22	-112.75	-110.46	-129.44	-127.37
3.00	-81.91	-101.47	-109.44	-107.67	-122.98	-122.54
4.00	-76.83	-97.97	-103.94	-105.86	-124.68	-124.28
5.00	-79.34	-97.02	-105.14	-103.59	-121.50	-119.06
6.00	-73.62	-95.24	-102.93	-101.61	-120.63	-125.38
7.00	-75.86	-93.85	-101.53	-99.84	-122.19	-123.41
8.00	-69.38	-92.96	-100.43	-99.27	-126.31	-122.57
9.00	-72.57	-90.65	-99.07	-97.84	-120.49	-117.61
10.00	-71.56	-91.55	-98.58	-98.37	-121.82	-119.76
11.00	-68.30	-89.71	-97.80	-96.14	-117.76	-119.85
12.00	-69.36	-89.24	-97.34	-96.38	-119.78	-118.86
13.00	-68.40	-88.43	-96.80	-94.98	-119.06	-121.02
14.00	-71.30	-88.43	-96.77	-94.11	-117.03	-118.26
15.00	-67.08	-88.35	-95.77	-94.06	-113.16	-121.12
15.50	-66.54	-87.09	-95.35	-93.61	-115.09	-117.45
16.00	-66.95	-86.10	-95.60	-93.30	-122.02	-118.75
16.50	-71.00	-86.87	-95.41	-92.58	-117.99	-119.61
17.00	-64.99	-87.14	-94.48	-92.63	-116.67	-118.65
17.50	-67.94	-86.78	-94.00	-91.94	-119.35	-120.50
18.00	-68.92	-85.71	-93.79	-92.25	-118.91	-117.75
18.50	-67.29	-85.76	-94.04	-92.16	-116.14	-116.47
19.00	-66.23	-85.77	-93.03	-91.67	-115.17	-113.91
19.50	-63.07	-85.76	-92.99	-92.46	-114.83	-115.27
20.00	-65.51	-85.04	-93.04	-90.62	-115.79	-113.23
20.50	-64.81	-83.45	-91.84	-91.96	-115.82	-115.85
21.00	-66.54	-84.63	-91.97	-89.59	-113.75	-115.51
21.50	-66.04	-84.07	-89.38	-89.79	-115.21	-116.20
22.00	-62.60	-83.25	-90.51	-90.05	-112.51	-115.98
22.50	-65.68	-84.37	-91.10	-90.08	-113.67	-113.83
23.00	-63.69	-83.37	-91.75	-89.91	-112.77	-115.11
23.50	-63.41	-84.12	-92.51	-88.91	-111.20	-116.78
24.00	-65.83	-82.86	-90.71	-90.06	-111.62	-115.50
24.50	-61.75	-83.50	-88.24	-90.28	-111.94	-113.21
25.00	-65.05	-82.34	-89.35	-89.36	-107.77	-113.02
25.50	-63.93	-81.95	-90.72	-88.58	-109.36	-111.17
26.00	-65.47	-82.18	-90.46	-88.25	-111.40	-110.76
26.50	-63.54	-83.03	-89.80	-88.77	-110.81	-110.71
27.00	-60.97	-82.16	-89.62	-87.85	-108.56	-110.55
27.50	-63.54	-81.43	-90.04	-87.46	-106.88	-112.71
28.00	-59.73	-81.99	-90.08	-87.63	-111.86	-112.27
28.50	-60.69	-82.27	-87.53	-88.51	-109.93	-113.46
29.00	-64.33	-82.32	-88.91	-87.49	-111.46	-110.22
30.00	-60.89	-81.34	-89.70	-88.34	-108.94	-111.38

Typical Performance Data

Test Conditions: @ Temperature = 25°C.

Freq. Offsets (kHz)	Phase Noise vs. Offset Freq. at Frequency Output (dBc / Hz)					
	0.05 GHz	1 GHz	5 GHz	10 GHz	20 GHz	30 GHz
0.1	-114.66	-92.96	-79.34	-71.56	-65.51	-60.89
1	-128.12	-111.16	-97.02	-91.55	-85.04	-81.34
10	-132.04	-118.74	-105.14	-98.58	-93.04	-89.70
100	-129.77	-117.44	-103.59	-98.37	-90.62	-88.34
1000	-132.09	-127.88	-121.50	-121.82	-115.79	-108.94
10000	-127.43	-126.91	-119.06	-119.76	-113.23	-111.38

Freq. (GHz)	Spurious (dBc)
0.05	-73.81
0.50	-79.99
1.00	-79.06
2.00	-77.04
3.00	-75.26
4.00	-74.98
5.00	-73.33
6.00	-68.05
7.00	-69.18
8.00	-71.19
9.00	-68.43
10.00	-69.01
11.00	-66.77
12.00	-68.37
13.00	-60.08
14.00	-62.19
15.00	-60.71
15.50	-63.70
16.00	-67.10
16.50	-61.63
17.00	-61.12
17.50	-62.82
18.00	-63.77
18.50	-51.87
19.00	-63.04
19.50	-63.53
20.00	-62.94
20.50	-62.34
21.00	-59.49
21.50	-55.50
22.00	-58.73
22.50	-60.20
23.00	-59.44
23.50	-60.18
24.00	-56.29
24.50	-54.94
25.00	-52.79
25.50	-54.17
26.00	-54.32
26.50	-53.13
27.00	-54.39
27.50	-53.90
28.00	-55.94
28.50	-56.27
29.00	-54.40
30.00	-54.11

Typical Performance Data

Test Conditions: @ Temperature = 50°C.

Freq. (GHz)	Power deviation from nominal vs. Output Frequency (dB)									
	-30 dBm	-20 dBm	-10 dBm	0 dBm	+5 dBm	+10 dBm	+15 dBm	+20 dBm	+22 dBm	+25 dBm
0.05	1.79	0.81	0.76	0.58	1.06	0.88	0.67	0.28	-0.03	-0.51
0.50	0.91	0.88	0.78	0.71	0.86	0.78	0.69	0.67	0.43	0.40
1.00	0.99	0.31	0.42	0.71	0.96	0.56	0.48	0.27	0.12	0.03
2.00	1.44	1.79	0.81	1.02	1.04	0.75	0.85	0.92	0.47	0.24
3.00	0.85	0.76	-0.25	-0.13	0.57	0.56	0.72	0.50	0.29	-0.15
4.00	0.89	1.14	0.21	0.71	0.86	0.56	0.86	0.54	0.40	0.13
5.00	-0.48	-0.81	-0.87	-0.67	-0.82	-0.56	-0.46	-0.73	-0.60	-1.05
6.00	0.62	0.29	0.08	0.18	-0.21	-0.32	-0.13	-0.13	-0.03	-0.42
7.00	0.22	0.52	0.46	0.15	0.19	0.24	-0.40	-1.09	-1.08	-1.16
8.00	1.33	1.07	0.53	0.52	0.60	0.57	-0.08	-0.28	-0.29	-0.52
9.00	-0.29	0.07	0.14	0.29	-0.05	0.17	-0.43	-0.51	-0.54	-0.89
10.00	1.28	0.29	0.34	0.08	0.09	-0.08	-0.05	-0.41	-0.66	-0.77
11.00	-0.44	-0.03	-0.73	-0.66	-0.67	-0.56	-1.18	-1.84	-1.45	-1.71
12.00	0.66	0.68	0.17	0.49	0.42	0.32	-0.73	-0.51	-0.82	-0.99
13.00	0.64	0.75	0.31	0.15	0.13	0.08	-0.74	-0.93	-0.67	-1.05
14.00	0.11	0.65	0.20	0.00	0.44	0.43	0.27	-1.49	-1.73	-1.70
15.00	0.51	0.53	0.86	0.45	0.62	0.69	-0.49	-0.38	-1.03	-1.60
15.50	-0.52	-0.32	-0.59	-0.08	-0.60	-0.54	-0.41	-0.76	-0.64	-1.62
16.00	-0.24	-0.10	-0.65	-0.17	-0.38	-0.53	-0.46	-0.64	-0.23	-0.09
16.50	-0.10	-0.10	-0.57	-0.71	-0.55	-0.40	-0.81	-0.55	-0.61	-0.21
17.00	-0.09	-0.30	-0.31	-0.38	-0.20	-0.09	-0.47	-0.20	-0.27	-0.02
17.50	-0.16	0.43	-0.20	-0.31	-0.19	-0.11	-0.50	-0.29	-0.38	-0.20
18.00	-0.02	-0.11	-0.61	-0.05	-0.56	-0.44	-0.54	-0.55	-0.11	-0.23
18.50	0.03	-0.15	-0.20	-0.37	-0.14	-0.48	-0.36	-0.18	-0.17	-0.25
19.00	-1.01	-1.19	-0.99	-0.93	-0.66	-1.21	-1.00	-0.86	-0.77	-0.28
19.50	0.09	-0.52	-0.80	-0.38	-0.55	-0.49	-0.63	-0.72	0.03	-0.28
20.00	0.04	-0.41	-0.52	-0.82	-0.52	-0.44	-0.33	-0.55	-0.08	-0.15
20.50	0.37	-0.04	-0.32	0.22	0.29	-0.09	-0.08	-0.38	0.03	-0.01
21.00	-0.47	-0.30	-0.52	-0.18	-0.03	-0.38	-0.29	-0.57	-0.44	-0.13
21.50	-0.52	-0.42	-0.68	-0.50	-0.30	-0.68	-0.54	-0.98	-0.73	--
22.00	0.00	-0.04	-0.35	-0.15	0.08	0.11	-0.24	0.05	0.14	--
22.50	-0.07	0.04	-0.53	-0.39	-0.19	-0.19	-0.12	-0.39	-0.23	--
23.00	-0.28	-0.32	-0.86	-0.35	-0.25	-0.55	-0.47	-0.27	-0.12	--
23.50	0.41	0.20	-0.43	0.01	0.15	-0.13	-0.02	-0.17	-0.07	--
24.00	0.35	0.16	-0.49	0.26	-0.07	0.08	-0.25	-0.09	0.00	--
24.50	-0.07	-0.23	-0.69	-0.37	-0.06	-0.03	-0.39	-0.16	-0.02	--
25.00	-0.14	-0.21	-0.76	-0.31	-0.06	-0.48	-0.45	-0.26	-0.10	--
25.50	0.38	0.56	0.04	-0.05	-0.09	-0.12	-0.03	0.16	0.33	--
26.00	0.58	0.54	0.62	0.21	0.06	0.05	-0.03	0.60	0.58	--
26.50	0.16	0.90	-0.09	0.14	-0.25	0.00	-0.40	0.11	0.02	--
27.00	0.29	0.12	0.14	0.22	-0.02	0.08	0.02	0.42	0.04	--
27.50	0.20	0.34	0.10	-0.03	-0.30	-0.36	-0.60	-0.02	0.02	--
28.00	-0.01	0.10	-0.27	-0.08	-0.59	0.15	-0.35	-0.38	-0.10	--
28.50	0.40	0.26	0.02	0.12	-0.31	-0.21	-0.67	-0.21	0.09	--
29.00	0.30	0.81	0.46	0.16	-0.24	-0.13	-0.30	0.25	0.16	--
30.00	0.56	0.78	-0.07	0.30	0.01	0.06	0.21	0.49	-0.16	--

Typical Performance Data

Test Conditions: @ Temperature = 50°C.

Power (dBm)	Power deviation from nominal vs. Output Power (dBm)									
	0.05 GHz	1 GHz	5 GHz	10 GHz	15 GHz	18 GHz	21 GHz	25 GHz	27 GHz	30 GHz
-30	1.79	0.99	-0.48	1.28	0.51	-0.02	-0.47	-0.14	0.29	0.56
-29	1.25	0.85	-0.59	1.25	0.56	-0.01	-0.44	-0.12	0.32	0.59
-28	0.70	0.72	-0.70	1.23	0.61	0.00	-0.41	-0.10	0.35	0.62
-27	0.84	0.44	-0.74	0.97	0.78	0.02	-0.33	-0.12	0.46	0.67
-26	0.98	0.17	-0.78	0.70	0.96	0.03	-0.25	-0.14	0.57	0.71
-25	1.08	0.13	-0.70	0.73	0.96	-0.27	-0.21	-0.10	0.55	0.55
-24	1.18	0.09	-0.63	0.75	0.96	-0.57	-0.18	-0.05	0.53	0.38
-23	0.90	0.35	-0.58	0.74	0.63	-0.54	-0.25	-0.13	0.51	0.48
-22	0.62	0.62	-0.53	0.73	0.30	-0.52	-0.32	-0.20	0.49	0.59
-21	0.71	0.46	-0.67	0.51	0.42	-0.31	-0.31	-0.21	0.31	0.68
-20	0.81	0.31	-0.81	0.29	0.53	-0.11	-0.30	-0.21	0.12	0.78
-18	0.71	0.33	-1.01	0.28	0.81	0.04	-0.17	0.49	0.27	0.41
-16	0.97	0.20	-0.70	-0.16	0.71	-0.24	-0.45	0.10	-0.04	0.30
-14	0.62	0.55	-0.58	-0.07	0.38	-0.29	-0.67	-0.10	-0.23	0.39
-12	0.71	0.52	-0.80	0.30	0.38	-0.69	-0.56	-0.66	0.03	0.31
-10	0.76	0.42	-0.87	0.34	0.86	-0.61	-0.52	-0.76	0.14	-0.07
-8	0.72	0.51	-1.02	0.22	0.09	-0.60	-0.46	-0.60	0.28	-0.13
-6	0.73	0.52	-0.87	0.29	0.20	-0.56	-0.38	-0.71	0.02	0.49
-4	0.99	0.50	-0.88	0.37	0.47	-0.55	-0.36	-0.63	0.10	0.40
-2	0.59	0.78	-0.69	0.10	0.53	-0.50	-0.40	-0.74	0.10	0.23
0	0.58	0.71	-0.67	0.08	0.45	-0.05	-0.18	-0.31	0.22	0.30
+1	0.84	0.68	-0.74	0.12	0.47	-0.36	-0.15	-0.23	0.00	0.16
+2	1.10	0.66	-0.82	0.15	0.49	-0.67	-0.12	-0.16	-0.21	0.02
+3	1.08	0.76	-0.84	0.10	0.65	-0.62	-0.08	-0.13	0.00	-0.05
+4	1.07	0.87	-0.85	0.04	0.80	-0.58	-0.05	-0.10	0.22	-0.11
+5	1.06	0.96	-0.82	0.09	0.62	-0.56	-0.03	-0.06	-0.02	0.01
+6	1.05	1.05	-0.79	0.14	0.44	-0.54	-0.02	-0.03	-0.26	0.13
+7	1.02	0.80	-0.52	0.00	0.43	-0.52	-0.23	-0.10	-0.17	0.07
+8	0.99	0.55	-0.25	-0.13	0.42	-0.51	-0.45	-0.16	-0.09	0.00
+9	0.94	0.56	-0.40	-0.10	0.55	-0.47	-0.41	-0.32	0.00	0.03
+10	0.88	0.56	-0.56	-0.08	0.69	-0.44	-0.38	-0.48	0.08	0.06
+11	0.84	0.79	-0.69	-0.01	0.10	-0.43	-0.37	-0.53	0.17	0.02
+12	0.80	1.01	-0.83	0.05	-0.49	-0.42	-0.36	-0.58	0.25	-0.02
+13	0.61	0.72	-0.61	0.00	-0.44	-0.38	-0.32	-0.51	0.19	0.10
+14	0.41	0.42	-0.38	-0.05	-0.39	-0.33	-0.28	-0.43	0.13	0.23
+15	0.67	0.48	-0.46	-0.05	-0.49	-0.54	-0.29	-0.45	0.02	0.21
+16	0.93	0.53	-0.54	-0.06	-0.58	-0.74	-0.30	-0.47	-0.10	0.19
+17	0.74	0.50	-0.55	-0.22	-0.49	-0.69	-0.25	-0.37	0.00	0.24
+18	0.55	0.47	-0.55	-0.38	-0.40	-0.63	-0.20	-0.27	0.09	0.30
+19	0.41	0.37	-0.64	-0.40	-0.39	-0.59	-0.38	-0.26	0.26	0.39
+20	0.28	0.27	-0.73	-0.41	-0.38	-0.55	-0.57	-0.26	0.42	0.49
+21	0.13	0.20	-0.67	-0.54	-0.70	-0.33	-0.51	-0.18	0.23	0.16
+22	-0.03	0.12	-0.60	-0.66	-1.03	-0.11	-0.44	-0.10	0.04	-0.16
+23	-0.23	0.09	-0.88	-0.73	-1.04	0.26	-0.10	0.21	--	--
+24	-0.44	0.05	-1.17	-0.79	-1.06	0.63	0.24	0.52	--	--
+25	-0.51	0.03	-1.05	-0.77	-1.60	-0.23	-0.13	--	--	--

Typical Performance Data

Test Conditions: @ Temperature = 50°C.

Freq. (GHz)	Harmonics levels vs. Output Frequency (dBc)									
	-20 dBm					+10 dBm				
	F2	F3	F0.5	F1.5	F2.5	F2	F3	F0.5	F1.5	F2.5
0.05	-46.10	-7.01	--	--	--	-39.65	-10.69	--	--	--
0.50	-28.06	-8.33	--	--	--	-29.91	-8.32	--	--	--
1.00	-16.95	-8.92	--	--	--	-15.18	-7.83	--	--	--
2.00	-20.74	-43.13	--	--	--	-21.62	-45.14	--	--	--
3.00	-48.76	-48.99	--	--	--	-37.37	-67.23	--	--	--
4.00	-40.42	-51.41	--	--	--	-38.81	-62.71	--	--	--
5.00	-41.50	-45.60	--	--	--	-41.19	-65.77	--	--	--
6.00	-20.43	-46.25	--	--	--	-24.60	-52.52	--	--	--
7.00	-19.17	-43.30	--	--	--	-21.39	-53.96	--	--	--
8.00	-34.89	-43.83	--	--	--	-32.12	-58.67	--	--	--
9.00	-35.93	-42.40	--	--	--	-43.46	-65.23	--	--	--
10.00	-41.30	-42.38	--	--	--	-43.21	-64.97	--	--	--
11.00	-42.67	-40.49	--	--	--	-40.79	-61.32	--	--	--
12.00	-43.15	-35.96	--	--	--	-38.44	-69.49	--	--	--
13.00	-45.27	-35.83	--	--	--	-36.70	-61.43	--	--	--
14.00	-43.19	-37.61	--	--	--	-34.33	-61.15	--	--	--
15.00	-39.38	-36.47	-49.67	-44.88	-36.25	-36.33	-61.60	-67.64	-72.68	-65.27
15.50	-39.31	-36.33	-42.52	-35.86	-34.76	-32.94	-58.35	-71.43	-66.58	-67.27
16.00	-40.36	-35.09	-35.88	-42.22	-36.05	-31.46	-59.34	-65.17	-72.02	-66.54
16.50	-39.87	-33.36	-41.30	-46.31	-36.64	-33.51	-58.50	-73.30	-74.50	-66.86
17.00	-41.67	-51.34	-45.29	-44.00	-35.66	-33.14	-63.72	-75.37	-72.64	-67.74
17.50	-42.20	-53.18	-27.03	-42.51	-36.43	-42.13	-63.03	-56.96	-71.58	-68.93
18.00	-38.08	-55.26	-34.99	-39.81	-37.23	-53.81	-65.88	-65.39	-70.99	-69.67
18.50	-40.51	-54.15	-26.94	-41.85	-33.53	-43.54	-65.95	-56.65	-72.62	-65.17
19.00	-36.21	-52.67	-32.09	-39.92	-35.20	-38.05	-68.36	-60.97	-72.33	-63.96
19.50	-36.39	-55.83	-42.52	-40.26	-34.42	-35.01	-66.36	-66.13	-72.64	-64.40
20.00	-35.82	-53.62	-37.04	-40.19	-33.31	-35.81	-64.52	-70.05	-72.07	-63.78
20.50	-38.21	-50.45	-36.30	-40.48	-53.56	-36.44	-64.08	-66.95	-71.86	-66.24
21.00	-37.33	-49.60	-34.65	-40.81	-51.17	-38.96	-61.73	-55.77	-70.87	-68.11
21.50	-36.51	-47.54	-34.65	-38.40	-54.76	-39.49	-61.16	-56.76	-67.94	-67.81
22.00	-32.22	-53.50	-42.33	-41.51	-55.58	-37.85	-62.97	-60.96	-67.33	-68.01
22.50	-34.43	-51.75	-36.67	-39.13	-53.95	-37.19	-65.26	-60.72	-71.25	-69.89
23.00	-32.47	-52.95	-30.89	-40.99	-54.06	-38.16	-65.47	-61.22	-69.25	-69.61
23.50	-33.36	-48.82	-22.46	-39.62	-54.14	-38.20	-64.33	-51.13	-69.43	-70.18
24.00	-34.33	-48.32	-31.66	-39.26	-54.74	-40.60	-67.31	-53.25	-70.29	-68.04
24.50	-35.95	-47.21	-24.00	-37.85	-54.81	-44.23	-66.14	-58.71	-71.29	-68.39
25.00	-33.17	-44.54	-18.81	-39.15	-51.62	-42.76	-64.72	-50.51	-67.38	-64.93
25.50	-52.02	-49.12	-29.36	-37.36	-57.00	-44.56	-64.06	-60.81	-71.07	-68.02
26.00	-52.36	-50.78	-25.60	-37.64	-54.59	-45.26	-61.94	-56.72	-67.10	-69.08
26.50	-55.73	-49.42	-26.70	-37.61	-54.84	-46.92	-62.92	-54.52	-68.54	-68.18
27.00	-53.39	-49.65	-24.55	-38.67	-55.50	-50.84	-62.98	-52.66	-66.74	-70.40
27.50	-54.62	-51.34	-29.68	-37.60	-55.22	-50.10	-65.30	-55.61	-68.29	-67.56
28.00	-52.90	-51.62	-33.52	-36.44	-53.16	-50.70	-65.18	-55.18	-66.51	-66.75
28.50	-51.39	-51.48	-28.18	-34.81	-53.65	-50.84	-66.69	-53.01	-65.89	-68.40
29.00	-55.79	-51.56	-28.84	-36.68	-52.03	-50.61	-64.01	-59.28	-66.62	-67.97
30.00	-55.70	-52.63	-23.13	-35.97	-48.02	-45.63	-65.11	-50.92	-68.77	-62.41

Note: No sub-harmonics below 15 GHz.

Typical Performance Data

Test Conditions: @ Temperature = 50°C.

Freq. (GHz)	Harmonics levels vs. Output Frequency (dBc)				
	+20 dBm				
	F2	F3	F0.5	F1.5	F2.5
0.05	-39.76	-10.61	--	--	--
0.50	-32.58	-8.50	--	--	--
1.00	-15.14	-7.76	--	--	--
2.00	-19.06	-38.66	--	--	--
3.00	-26.28	-45.62	--	--	--
4.00	-25.10	-30.87	--	--	--
5.00	-30.11	-46.52	--	--	--
6.00	-28.67	-41.29	--	--	--
7.00	-24.43	-44.77	--	--	--
8.00	-26.54	-43.01	--	--	--
9.00	-31.72	-45.31	--	--	--
10.00	-40.80	-48.51	--	--	--
11.00	-31.72	-45.85	--	--	--
12.00	-27.82	-63.29	--	--	--
13.00	-27.50	-44.95	--	--	--
14.00	-26.67	-48.09	--	--	--
15.00	-25.51	-42.05	-68.90	-82.84	-75.35
15.50	-19.74	-35.35	-80.74	-76.72	-77.06
16.00	-18.73	-36.54	-74.93	-80.27	-73.34
16.50	-21.00	-39.70	-80.98	-84.43	-77.32
17.00	-20.62	-43.48	-85.61	-83.36	-75.00
17.50	-29.94	-43.43	-67.94	-81.64	-77.90
18.00	-43.79	-47.81	-74.19	-77.70	-76.14
18.50	-31.32	-48.85	-65.70	-79.70	-75.00
19.00	-25.41	-49.49	-71.63	-83.14	-74.14
19.50	-22.74	-46.14	-72.90	-79.81	-73.78
20.00	-24.04	-46.03	-67.75	-73.57	-75.11
20.50	-24.55	-45.02	-59.77	-68.98	-74.46
21.00	-27.08	-39.10	-56.91	-67.05	-75.40
21.50	-27.21	-39.15	-60.93	-69.82	-76.24
22.00	-24.46	-40.70	-60.34	-70.52	-79.12
22.50	-24.58	-44.50	-60.22	-69.63	-82.05
23.00	-24.37	-48.34	-60.31	-70.95	-78.36
23.50	-24.99	-46.86	-57.79	-77.68	-77.03
24.00	-26.12	-49.70	-54.85	-78.29	-79.25
24.50	-28.19	-54.92	-60.37	-73.24	-79.74
25.00	-28.93	-59.05	-61.11	-73.04	-79.46
25.50	-30.52	-53.94	-75.70	-78.24	-77.97
26.00	-31.57	-56.97	-68.29	-73.08	-79.04
26.50	-33.30	-55.92	-60.16	-73.79	-76.72
27.00	-37.35	-61.11	-56.60	-69.35	-81.10
27.50	-36.91	-59.28	-56.82	-69.57	-76.91
28.00	-38.11	-60.13	-55.95	-68.56	-78.11
28.50	-38.67	-60.29	-54.92	-70.58	-75.03
29.00	-38.36	-70.58	-56.18	-69.66	-75.60
30.00	-30.31	-54.23	-56.78	-74.22	-75.69

Note: No sub-harmonics below 15 GHz.

Typical Performance Data

Test Conditions: @ Temperature = 50°C.

Freq. (GHz)	Phase Noise vs. Output Freq. at Frequency Offsets (dBc / Hz)					
	100 Hz	1 kHz	10 kHz	100 kHz	1 MHz	10 MHz
0.05	-117.29	-127.00	-129.50	-129.71	-128.21	-128.58
0.50	-97.59	-115.52	-122.76	-123.06	-130.91	-126.29
1.00	-90.58	-110.05	-117.76	-116.70	-129.99	-126.04
2.00	-88.20	-103.54	-111.41	-111.74	-126.59	-126.57
3.00	-81.88	-100.91	-108.63	-108.31	-123.36	-122.70
4.00	-76.02	-98.49	-106.63	-105.80	-123.42	-120.93
5.00	-75.17	-97.23	-103.63	-103.82	-119.81	-119.34
6.00	-78.60	-93.92	-103.25	-102.10	-125.51	-121.77
7.00	-73.86	-93.04	-100.70	-100.55	-120.76	-119.94
8.00	-72.51	-91.10	-99.22	-99.02	-120.87	-121.37
9.00	-71.12	-91.01	-98.67	-97.66	-119.97	-119.32
10.00	-69.36	-90.51	-97.57	-97.07	-125.66	-122.11
11.00	-65.86	-89.15	-97.70	-95.83	-118.43	-118.40
12.00	-72.50	-88.31	-96.35	-94.50	-120.27	-119.13
13.00	-68.09	-87.62	-96.41	-95.15	-119.55	-119.66
14.00	-67.51	-86.38	-94.00	-94.79	-115.23	-118.35
15.00	-66.01	-87.49	-94.60	-93.70	-114.91	-116.92
15.50	-66.65	-86.17	-93.89	-92.96	-118.76	-118.84
16.00	-64.79	-86.18	-93.60	-93.21	-115.89	-118.02
16.50	-70.43	-86.61	-93.71	-92.29	-116.02	-118.43
17.00	-64.75	-85.97	-92.52	-93.34	-121.58	-118.97
17.50	-66.35	-85.51	-93.26	-92.08	-118.74	-115.20
18.00	-64.16	-83.87	-93.99	-92.66	-114.80	-118.44
18.50	-65.14	-84.89	-91.29	-91.40	-118.90	-118.98
19.00	-64.74	-85.39	-92.80	-91.49	-113.65	-115.48
19.50	-62.99	-84.47	-92.67	-92.54	-119.36	-118.65
20.00	-61.78	-85.08	-92.92	-92.75	-116.65	-114.01
20.50	-64.79	-83.65	-91.72	-90.55	-114.88	-115.50
21.00	-62.78	-84.51	-91.88	-90.78	-114.17	-117.98
21.50	-68.11	-83.27	-92.27	-89.90	-116.94	-112.48
22.00	-64.07	-83.03	-91.39	-90.41	-118.50	-117.15
22.50	-68.42	-84.31	-92.06	-91.01	-114.53	-118.37
23.00	-62.93	-83.09	-90.95	-89.78	-113.30	-115.49
23.50	-66.69	-83.84	-88.48	-90.63	-113.43	-113.51
24.00	-62.71	-83.14	-91.59	-89.59	-111.73	-113.67
24.50	-60.58	-81.60	-90.45	-89.60	-114.90	-114.47
25.00	-62.00	-82.03	-90.11	-89.03	-110.62	-116.14
25.50	-61.71	-81.90	-90.85	-88.68	-109.26	-114.12
26.00	-59.62	-81.22	-90.35	-87.92	-110.18	-115.43
26.50	-61.03	-82.95	-90.37	-88.55	-112.95	-111.28
27.00	-63.58	-82.41	-87.72	-88.80	-110.37	-115.81
27.50	-59.79	-81.61	-90.01	-87.65	-109.93	-110.65
28.00	-60.15	-80.93	-89.33	-88.06	-113.83	-111.38
28.50	-57.96	-80.79	-89.79	-87.22	-111.89	-114.27
29.00	-59.43	-80.53	-88.07	-87.62	-107.50	-113.48
30.00	-60.62	-81.25	-87.97	-87.09	-111.09	-112.96

Typical Performance Data

Test Conditions: @ Temperature = 50°C.

Freq. Offsets (kHz)	Phase Noise vs. Offset Freq. at Frequency Output (dBc / Hz)					
	0.05 GHz	1 GHz	5 GHz	10 GHz	20 GHz	30 GHz
0.1	-117.29	-90.58	-75.17	-69.36	-61.78	-60.62
1	-127.00	-110.05	-97.23	-90.51	-85.08	-81.25
10	-129.50	-117.76	-103.63	-97.57	-92.92	-87.97
100	-129.71	-116.70	-103.82	-97.07	-92.75	-87.09
1000	-128.21	-129.99	-119.81	-125.66	-116.65	-111.09
10000	-128.58	-126.04	-119.34	-122.11	-114.01	-112.96

Freq. (GHz)	Spurious (dBc)
0.05	-72.92
0.50	-78.51
1.00	-78.54
2.00	-76.58
3.00	-75.43
4.00	-74.84
5.00	-69.20
6.00	-69.39
7.00	-70.92
8.00	-70.35
9.00	-68.41
10.00	-66.94
11.00	-66.43
12.00	-66.21
13.00	-64.65
14.00	-63.51
15.00	-61.66
15.50	-63.22
16.00	-65.56
16.50	-63.85
17.00	-63.79
17.50	-63.18
18.00	-62.51
18.50	-63.27
19.00	-61.30
19.50	-61.52
20.00	-58.44
20.50	-63.73
21.00	-63.09
21.50	-58.17
22.00	-61.34
22.50	-61.84
23.00	-62.44
23.50	-58.45
24.00	-59.47
24.50	-61.59
25.00	-61.11
25.50	-55.51
26.00	-58.84
26.50	-58.58
27.00	-59.63
27.50	-56.08
28.00	-58.64
28.50	-55.40
29.00	-53.46
30.00	-56.26

Typical Performance Graphs

Test Conditions: @ Temperature = 0°C.

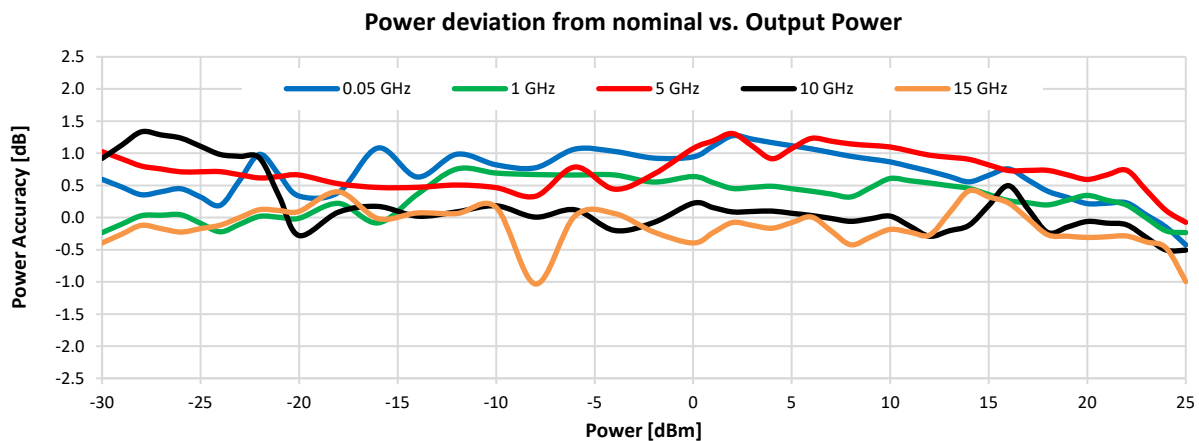
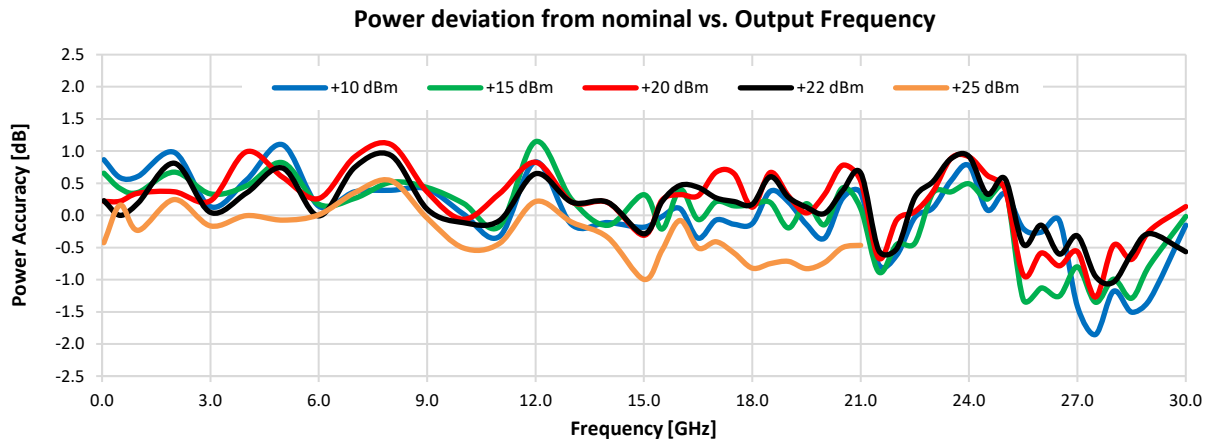
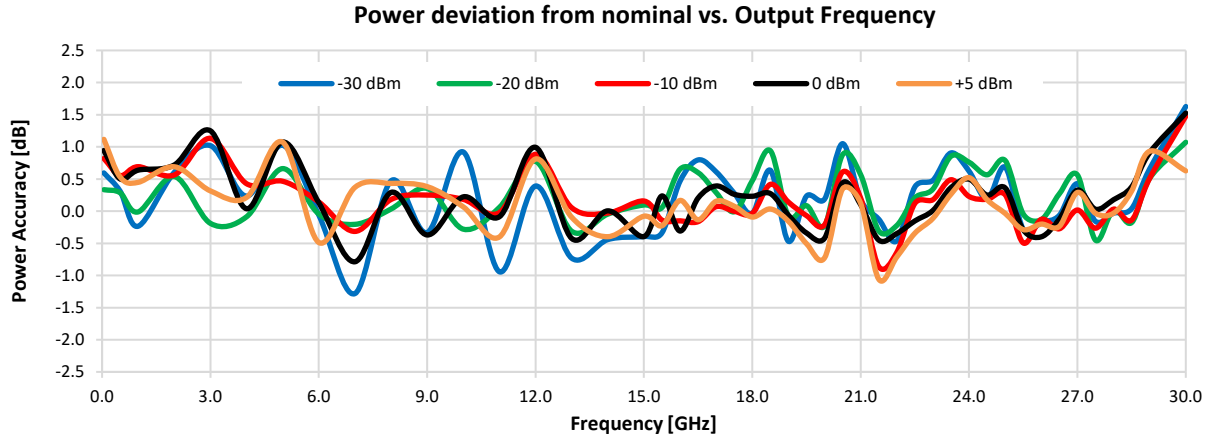

Typical Performance Graphs

Test Conditions: @ Temperature = 0°C.

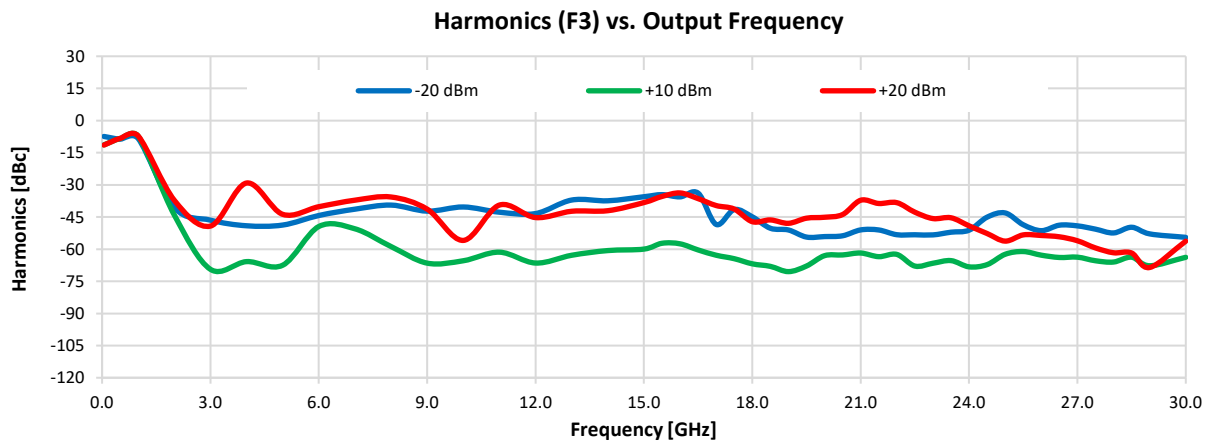
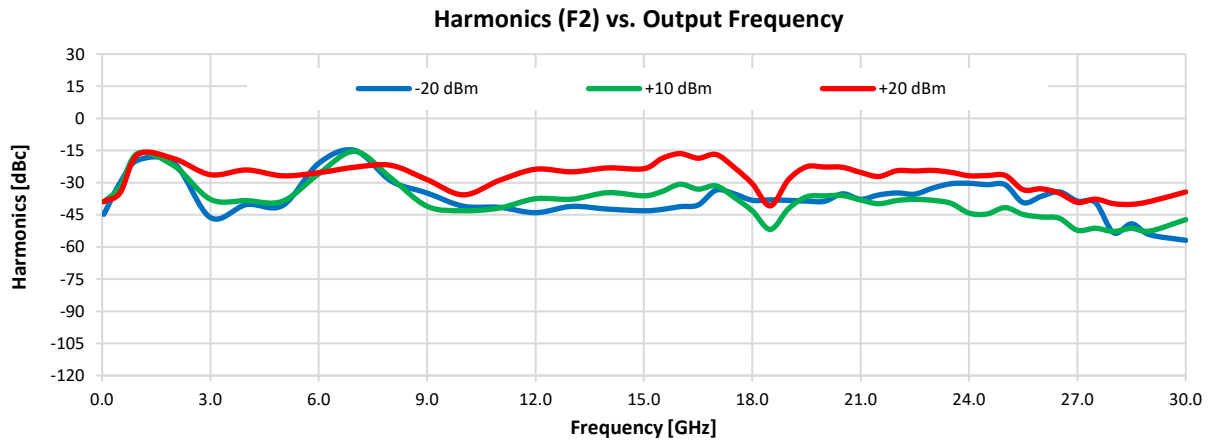
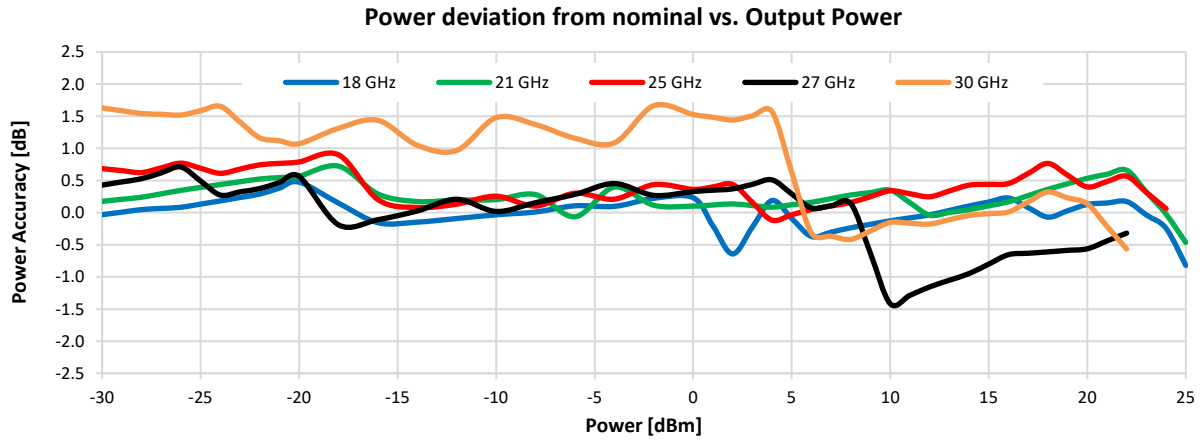

Typical Performance Graphs

Test Conditions: @ Temperature = 0°C.

Sub-Harmonics (F0.5) vs. Output Frequency

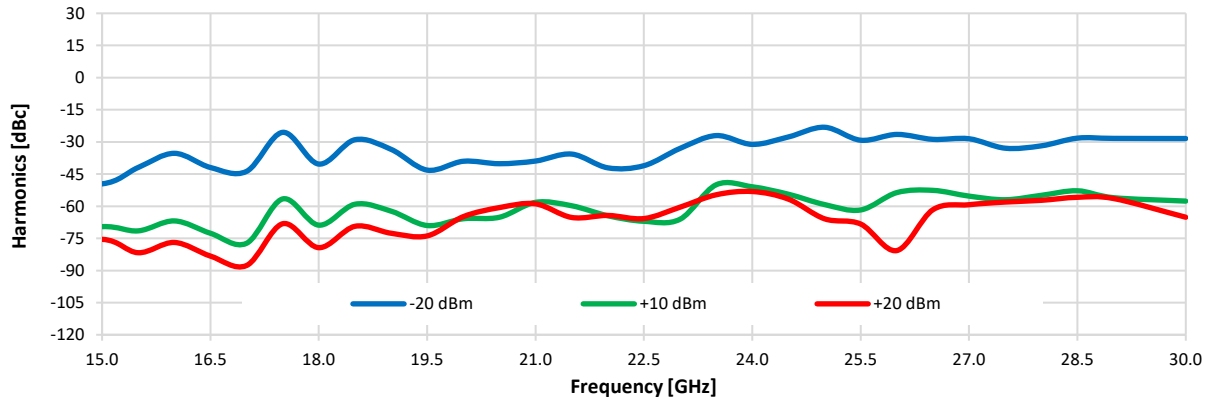

Sub-Harmonics (F1.5) vs. Output Frequency

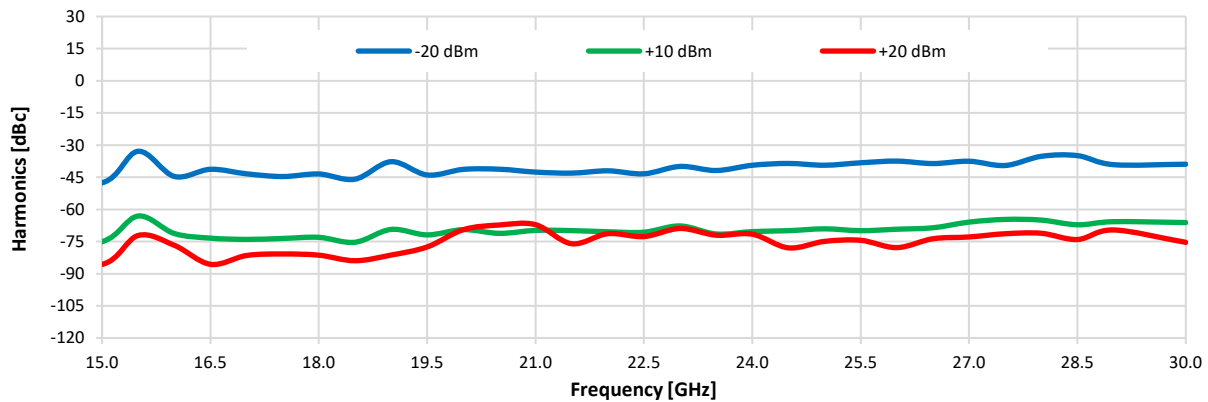

Sub-Harmonics (F2.5) vs. Output Frequency

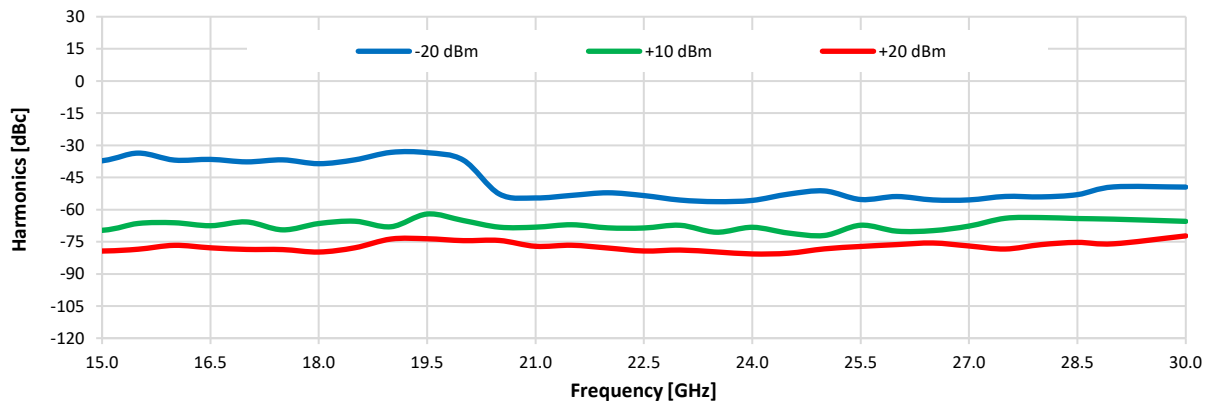

Note: No sub-harmonics below 15 GHz.

Typical Performance Graphs

Test Conditions: @ Temperature = 0°C.

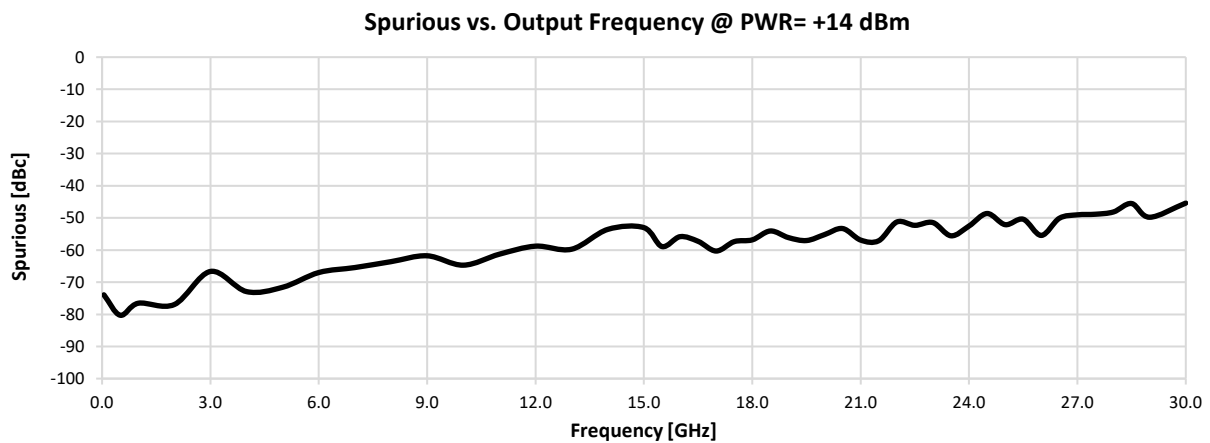
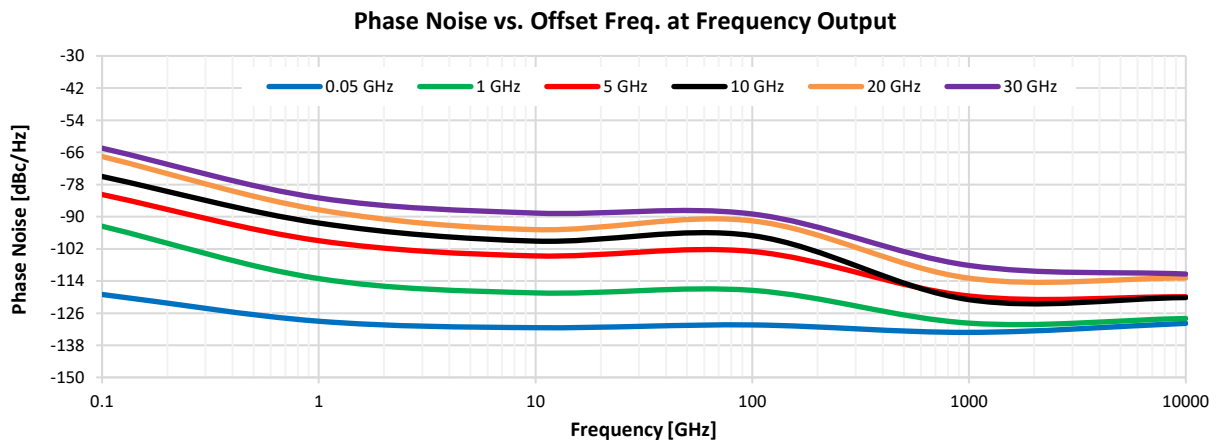
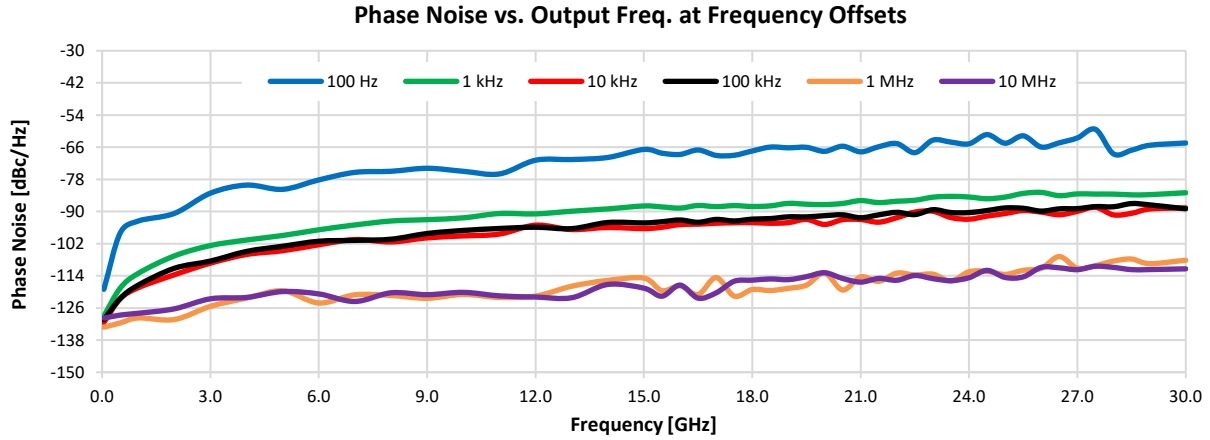

Typical Performance Graphs

Test Conditions: @ Temperature = 25°C.

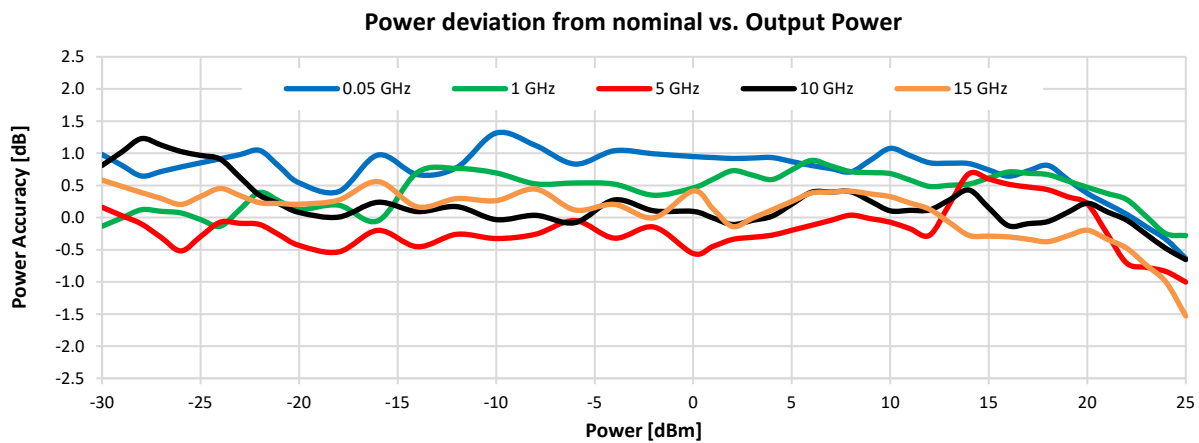
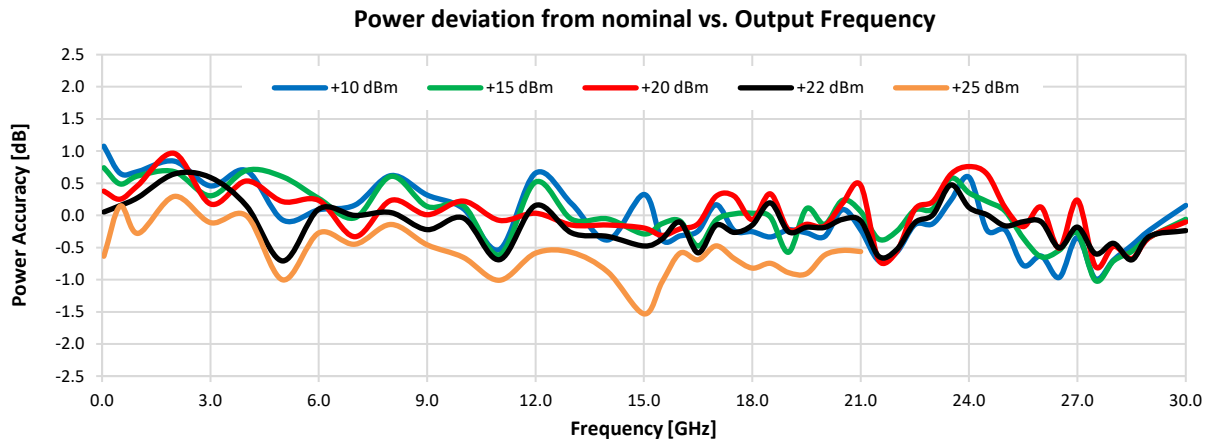
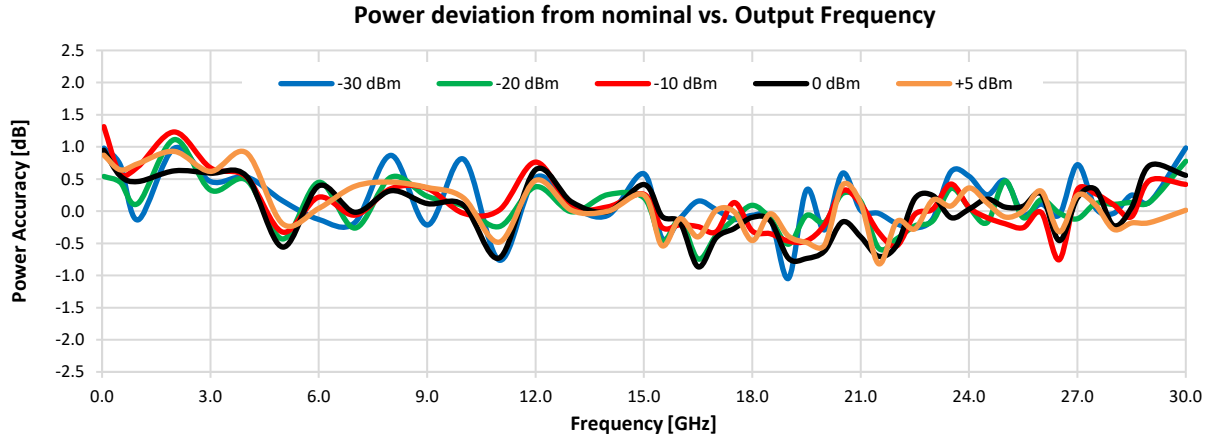

Typical Performance Graphs

Test Conditions: @ Temperature = 25°C.

Power deviation from nominal vs. Output Power

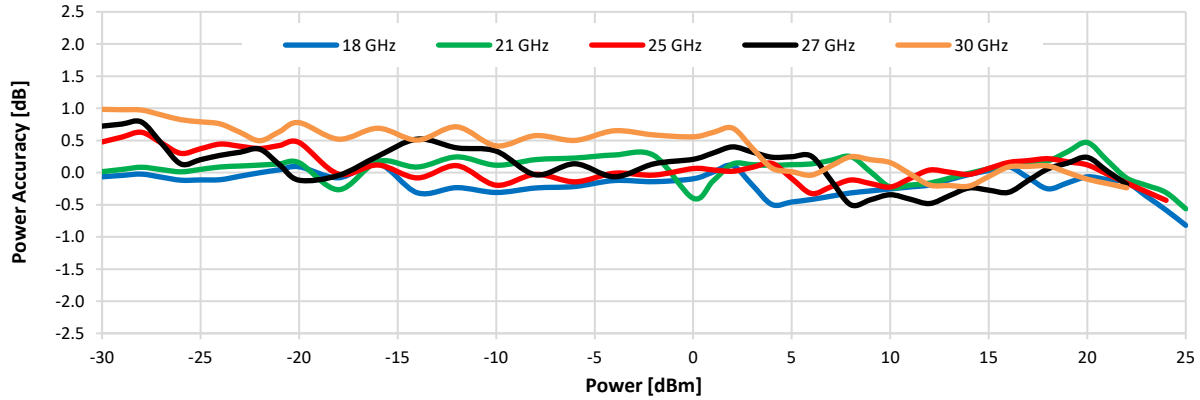

Harmonics (F2) vs. Output Frequency

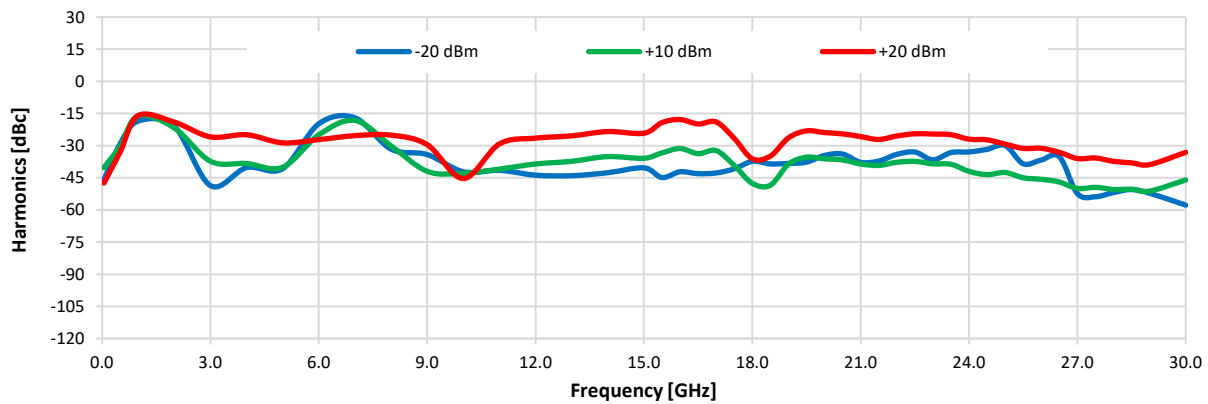

Harmonics (F3) vs. Output Frequency

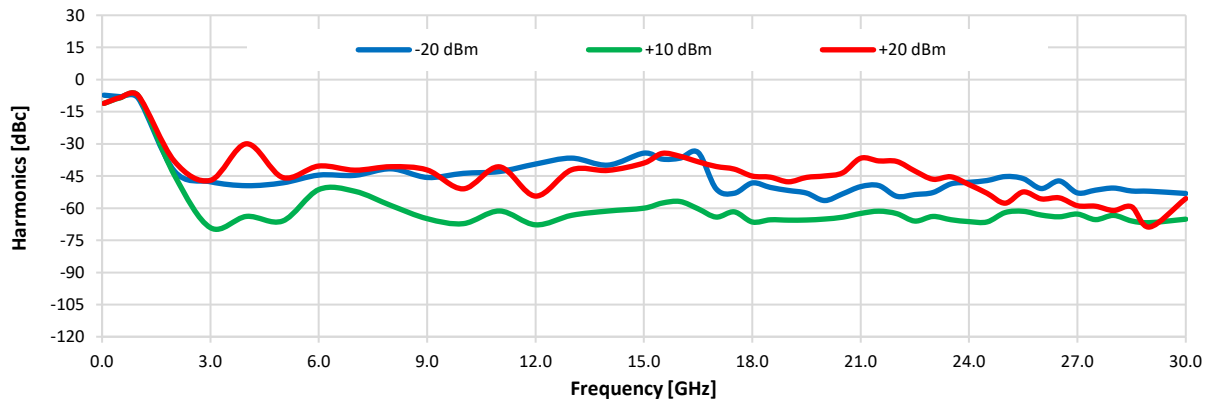

Typical Performance Graphs

Test Conditions: @ Temperature = 25°C.

Sub-Harmonics (F0.5) vs. Output Frequency

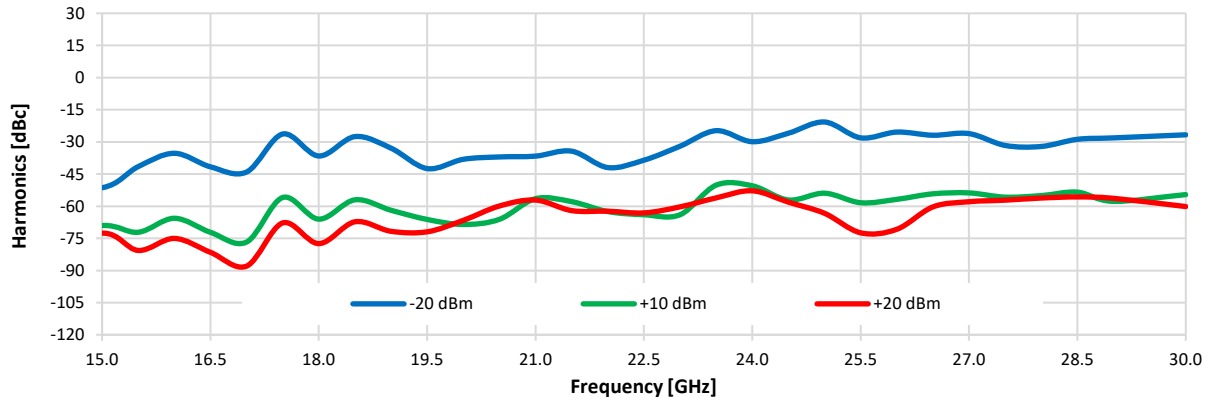

Sub-Harmonics (F1.5) vs. Output Frequency

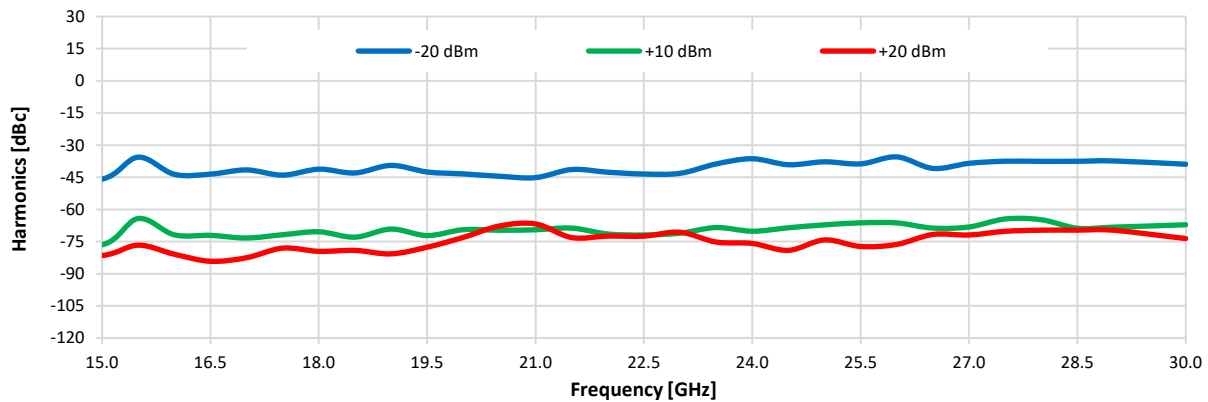

Sub-Harmonics (F2.5) vs. Output Frequency

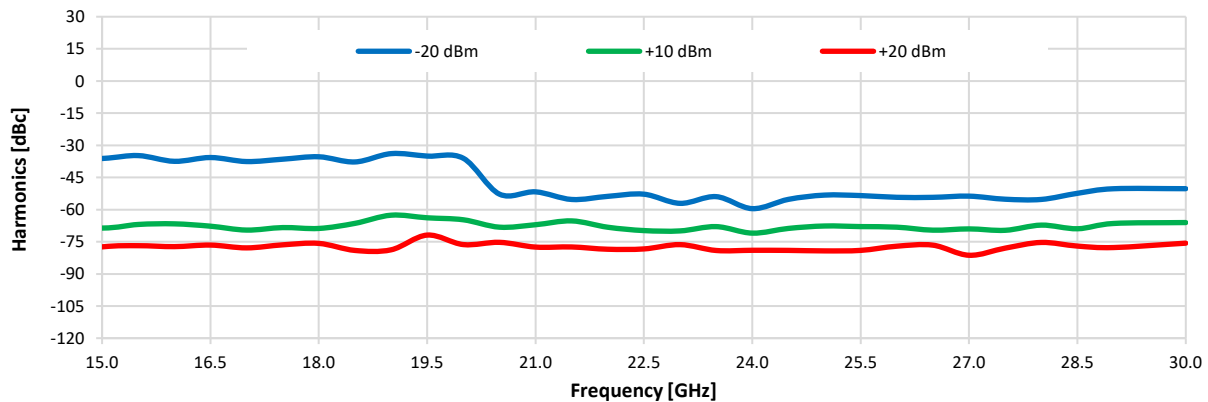

Note: No sub-harmonics below 15 GHz.

Typical Performance Graphs

Test Conditions: @ Temperature = 25°C.

Phase Noise vs. Output Freq. at Frequency Offsets

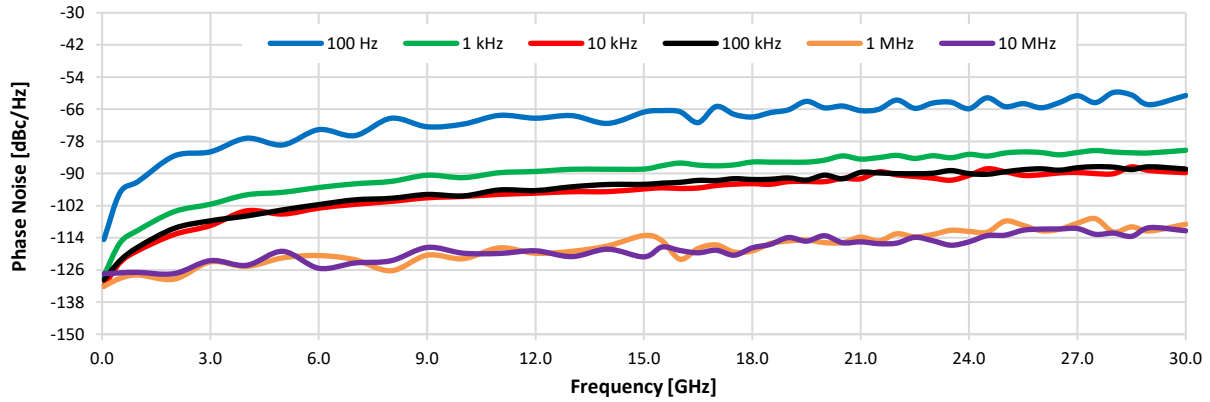

Phase Noise vs. Offset Freq. at Frequency Output

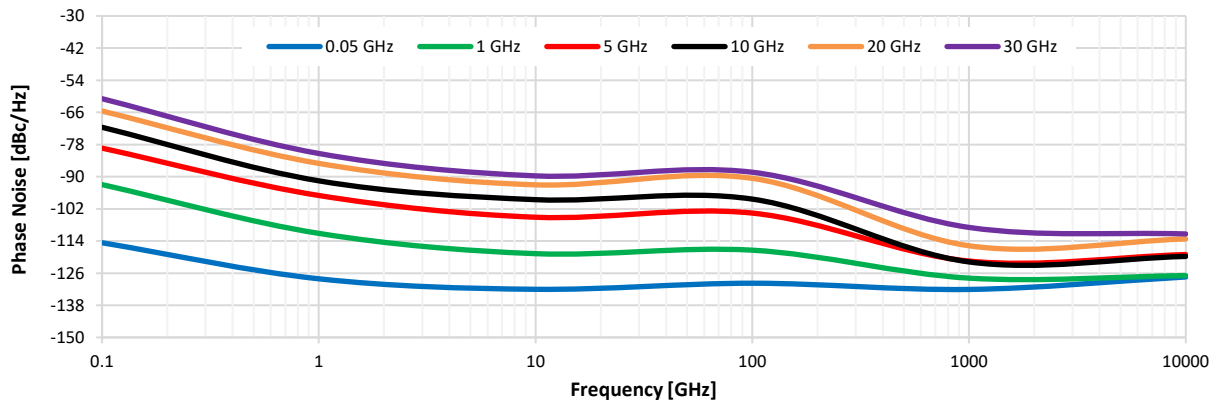

Spurious vs. Output Frequency @ PWR= +14 dBm

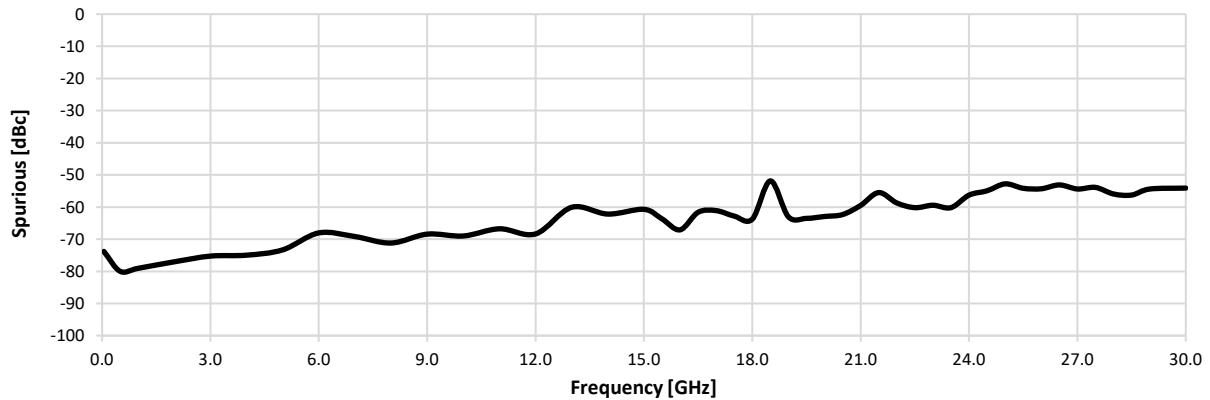

Typical Performance Graphs

Test Conditions: @ Temperature = 50°C.

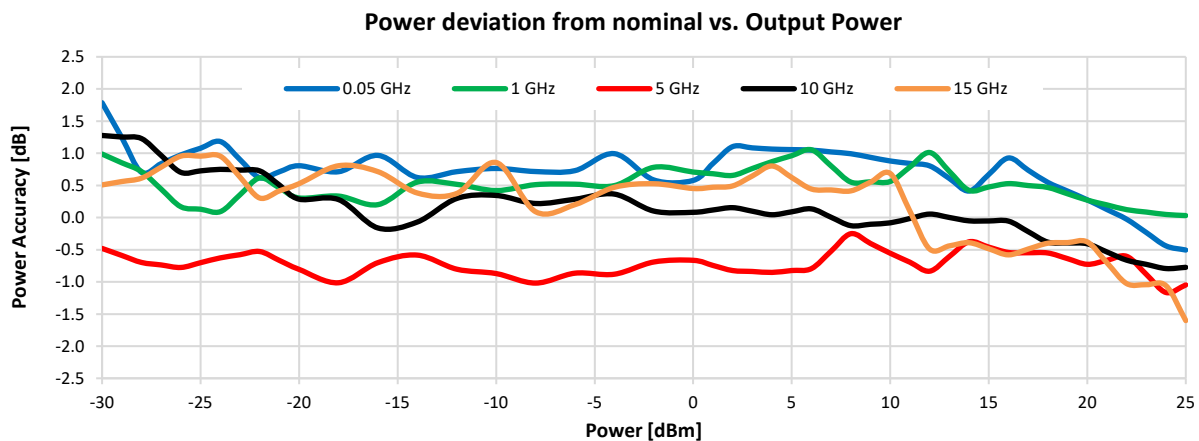
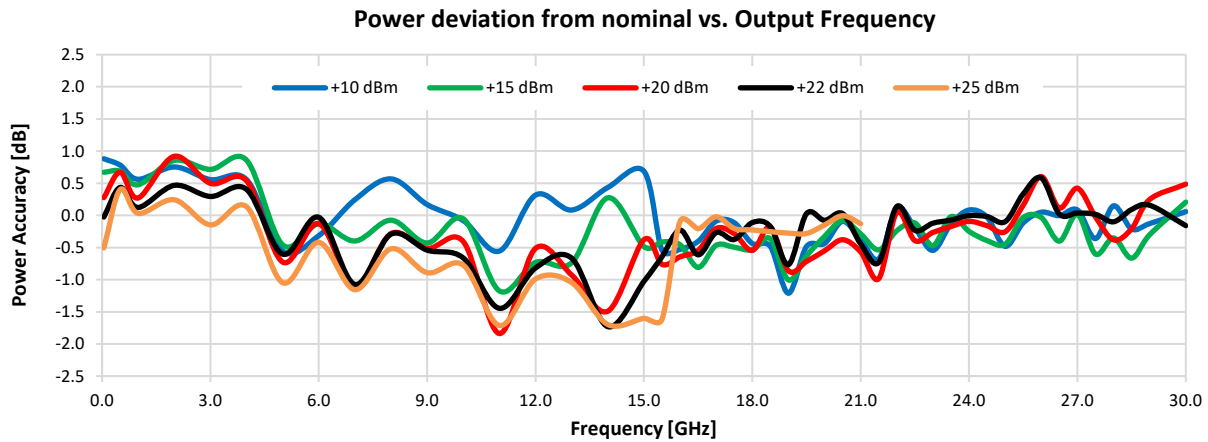
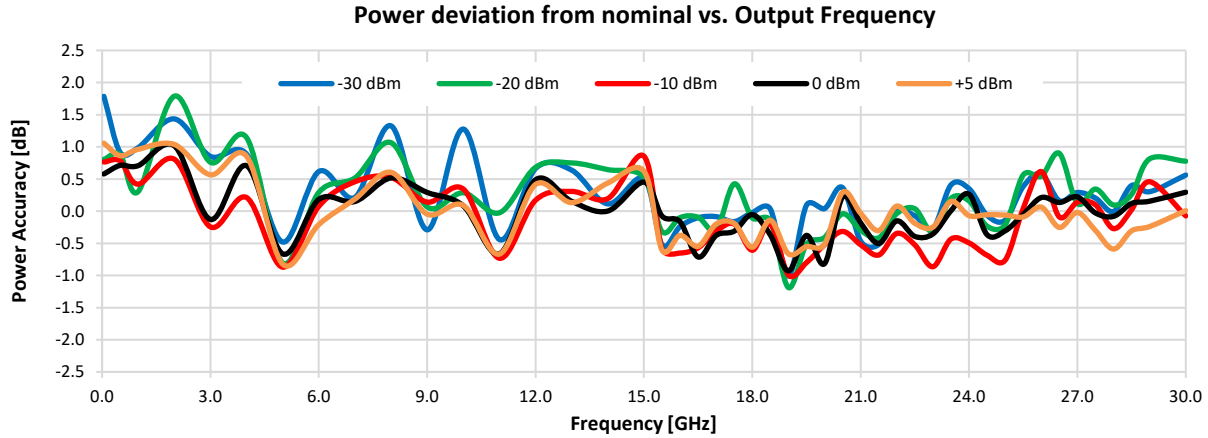

NOTES:

- A. Performance and quality attributes and conditions not expressly stated in this specification document are intended to be excluded and do not form a part of this specification document.
- B. Electrical specifications and performance data contained in this specification document are based on Mini-Circuit's applicable established test performance criteria and measurement instructions.
- C. The parts covered by this specification document are subject to Mini-Circuits standard limited warranty and terms and conditions (collectively, "Standard Terms"); Purchasers of this part are entitled to the rights and benefits contained therein. For a full statement of the Standard Terms and the exclusive rights and remedies thereunder, please visit Mini-Circuits' website at <https://www.minicircuits.com/terms/viewterm.html>



Typical Performance Graphs

Test Conditions: @ Temperature = 50°C.

Power deviation from nominal vs. Output Power

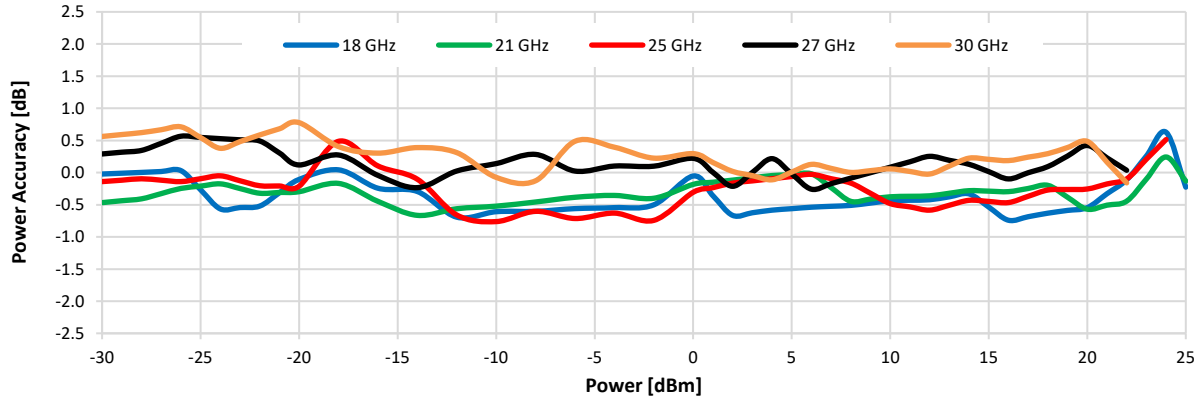

Harmonics (F2) vs. Output Frequency

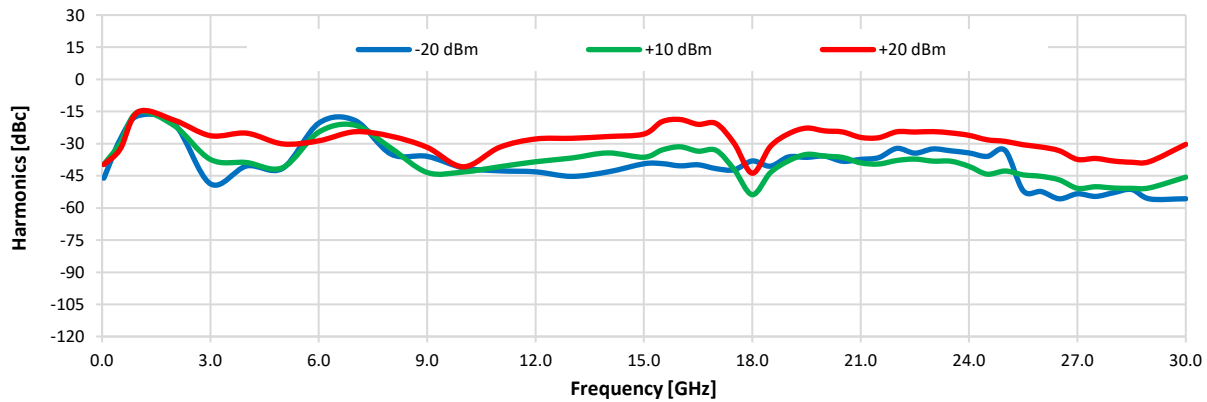

Harmonics (F3) vs. Output Frequency

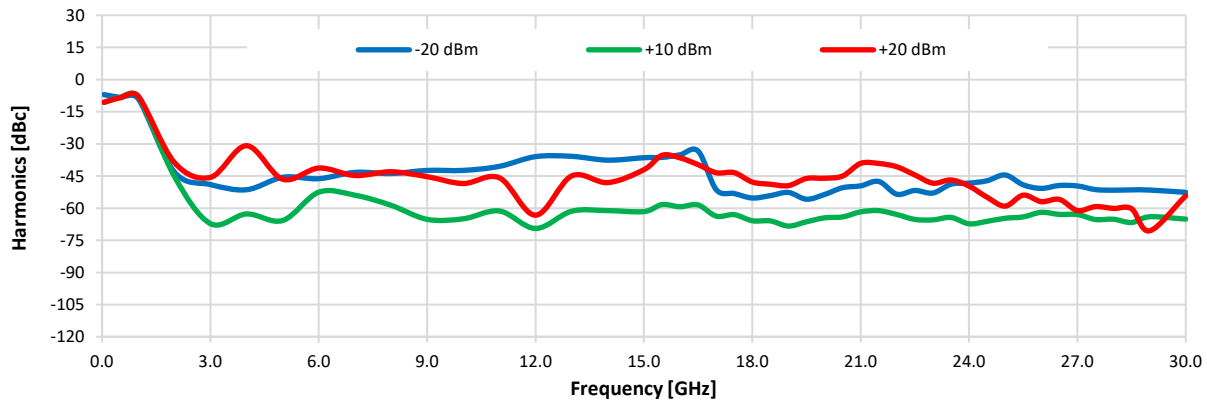

NOTES:

- A. Performance and quality attributes and conditions not expressly stated in this specification document are intended to be excluded and do not form a part of this specification document.
- B. Electrical specifications and performance data contained in this specification document are based on Mini-Circuits' applicable established test performance criteria and measurement instructions.
- C. The parts covered by this specification document are subject to Mini-Circuits standard limited warranty and terms and conditions (collectively, "Standard Terms"); Purchasers of this part are entitled to the rights and benefits contained therein. For a full statement of the Standard Terms and the exclusive rights and remedies thereunder, please visit Mini-Circuits' website at <https://www.minicircuits.com/terms/viewterm.html>



Typical Performance Graphs

Test Conditions: @ Temperature = 50°C.

Sub-Harmonics (F0.5) vs. Output Frequency

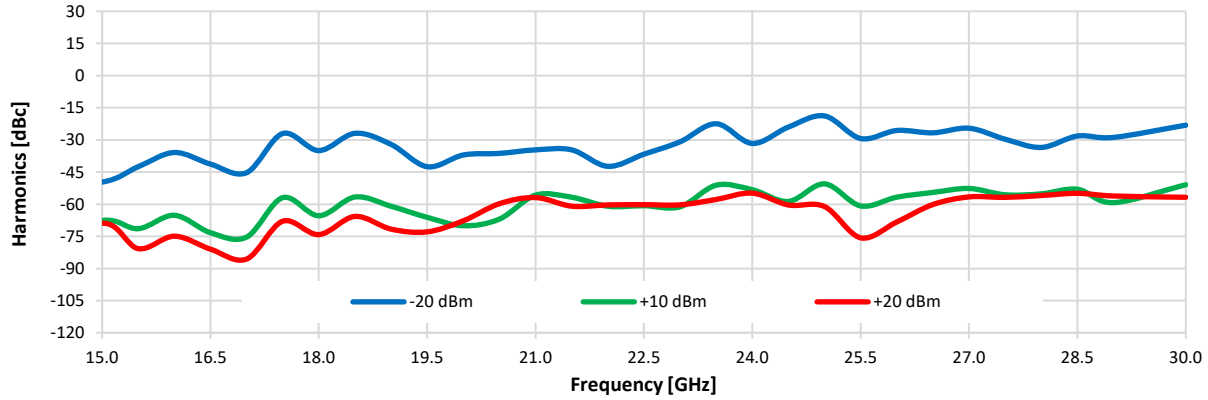

Sub-Harmonics (F1.5) vs. Output Frequency

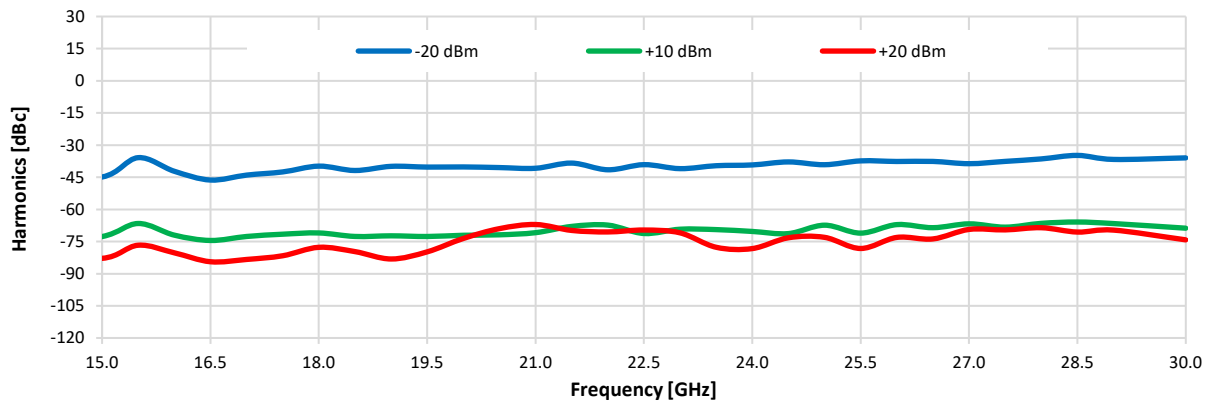

Sub-Harmonics (F2.5) vs. Output Frequency

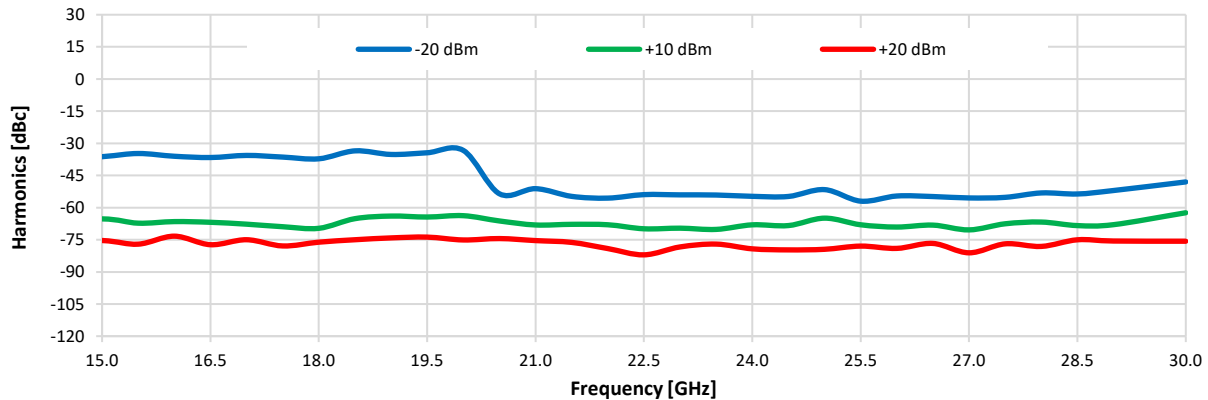

Note: No sub-harmonics below 15 GHz.

NOTES:

- A. Performance and quality attributes and conditions not expressly stated in this specification document are intended to be excluded and do not form a part of this specification document.
- B. Electrical specifications and performance data contained in this specification document are based on Mini-Circuit's applicable established test performance criteria and measurement instructions.
- C. The parts covered by this specification document are subject to Mini-Circuits standard limited warranty and terms and conditions (collectively, "Standard Terms"); Purchasers of this part are entitled to the rights and benefits contained therein. For a full statement of the Standard Terms and the exclusive rights and remedies thereunder, please visit Mini-Circuits' website at <https://www.minicircuits.com/terms/viewterm.html>



Typical Performance Graphs

Test Conditions: @ Temperature = 50°C.

Phase Noise vs. Output Freq. at Frequency Offsets

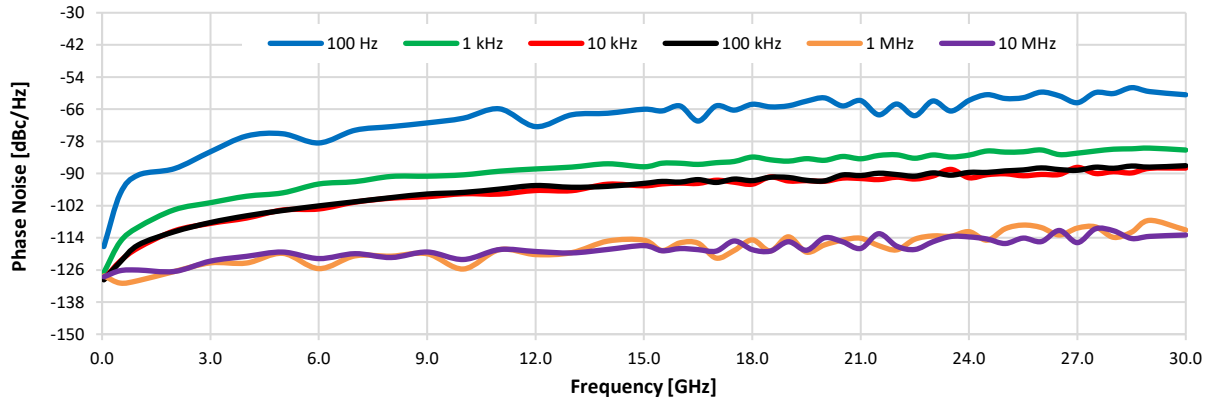

Phase Noise vs. Offset Freq. at Frequency Output

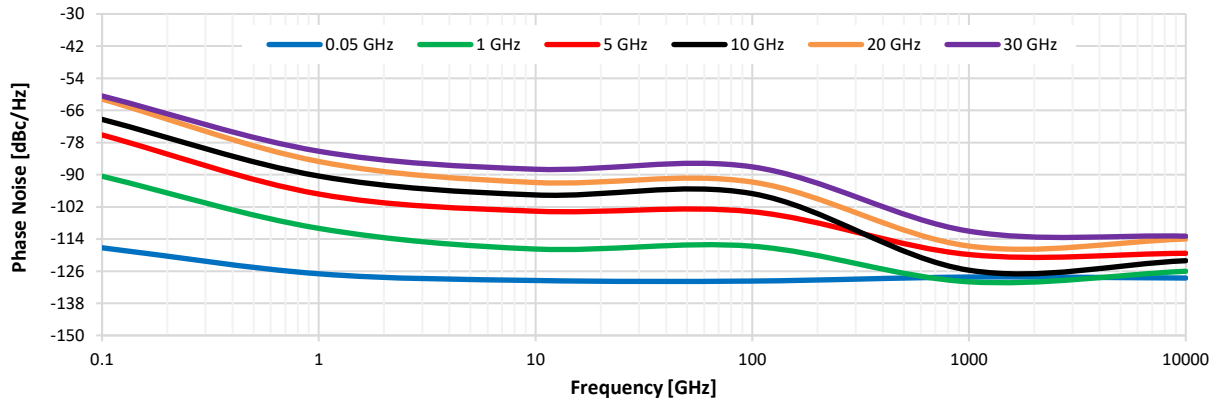

Spurious vs. Output Frequency @ PWR= +14 dBm

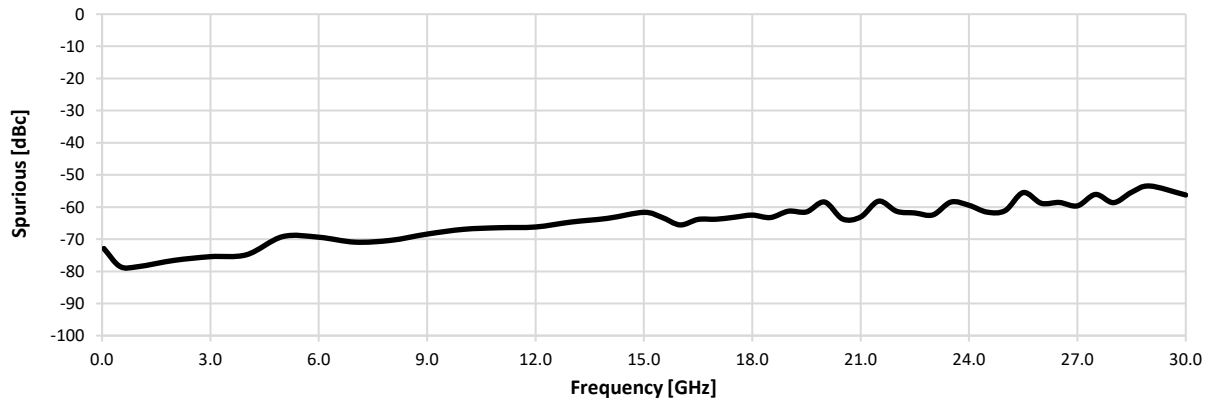

NOTES:

- A. Performance and quality attributes and conditions not expressly stated in this specification document are intended to be excluded and do not form a part of this specification document.
- B. Electrical specifications and performance data contained in this specification document are based on Mini-Circuits' applicable established test performance criteria and measurement instructions.
- C. The parts covered by this specification document are subject to Mini-Circuits standard limited warranty and terms and conditions (collectively, "Standard Terms"); Purchasers of this part are entitled to the rights and benefits contained therein. For a full statement of the Standard Terms and the exclusive rights and remedies thereunder, please visit Mini-Circuits' website at <https://www.minicircuits.com/terms/viewterm.html>



Case Style

SL

Outline Dimensions

SL3512

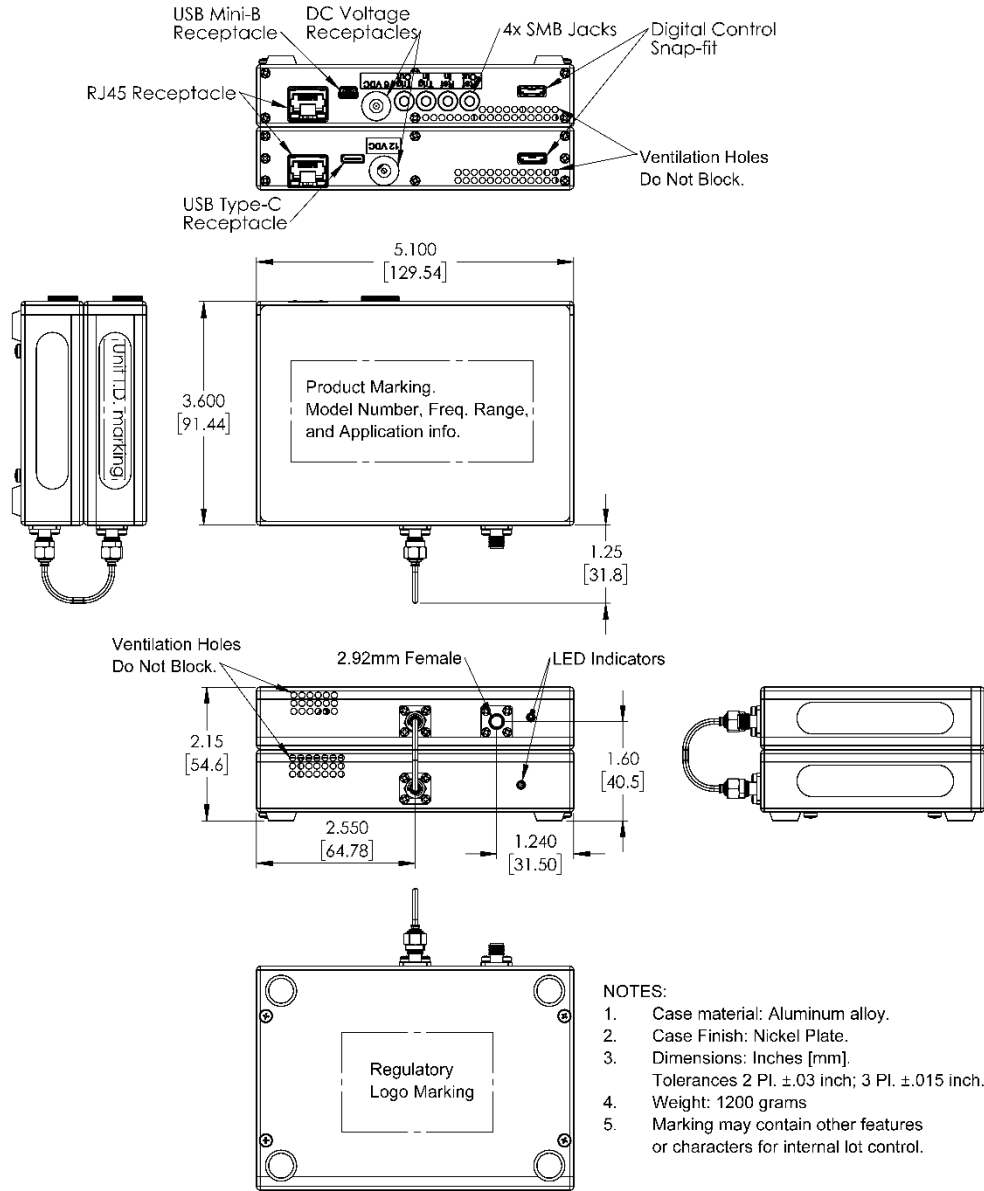

Rear Panel Details

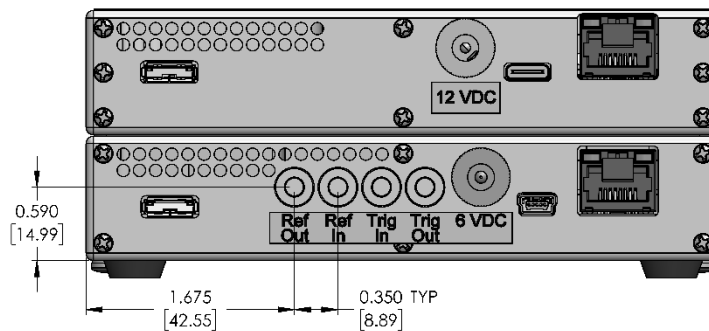

www.minicircuits.com P.O. Box 350166, Brooklyn, NY 11235-0003 (718) 934-4500 sales@minicircuits.com



Environmental Specifications **ENV55**

All Mini-Circuits products are manufactured under exacting quality assurance and control standards, and are capable of meeting published specifications after being subjected to any or all of the following physical and environmental test.

Specification	Test/Inspection Condition	Reference/Spec
Operating Temperature	-0° to 50° C Ambient Environment	Individual Model Data Sheet
Storage Temperature	-20° to 60° C Ambient Environment	Individual Model Data Sheet
Operating and Storage Humidity	5% to 85% RH (non-condensing)	Ambient
Bench Handling Test	Bench Top Tip 45° & Drop	MIL-PRF-28800F
Transit Drop Test	Free Fall Drop, 20 cm (7.9 inches)	MIL-PRF-28800F Class 3