



SURFACE MOUNT

Power Splitter/Combiner

SP-2U2+

2 Way-0° 50Ω 1720 to 2850 MHz

FEATURES

- Wide bandwidth
- Low insertion loss, 0.5 dB typ.
- Good isolation, 17 dB typ.
- Good output VSWR, 1.26:1 typ.
- Excellent power handling, 1.5W
- Small size
- Aqueous washable



Generic photo used for illustration purposes only

CASE STYLE: CA531

+RoHS Compliant

The +Suffix identifies RoHS Compliance. See our website for methodologies and qualifications

APPLICATIONS

- Bluetooth
- WCDMA
- IEEE 802.11b, g
- Wi-Fi
- PCS

ELECTRICAL SPECIFICATIONS AT 25°C

Parameter	Frequency (MHz)	Min.	Typ.	Max.	Units
Frequency Range		1720		2850	MHz
Insertion Loss (above 3.0 dB)	1720-2850	—	0.5	1.4	dB
Isolation	1720-2850	9	17	—	dB
Amplitude Unbalance	1720-2850	—	—	0.2	dB
Phase Unbalance	1720-2850	—	—	3	deg.
VSWR (Port S)	1720-2850	—	1.5	—	:1
VSWR (Port 1)	1720-2850	—	1.26	—	:1
VSWR (Port 2)	1720-2850	—	1.26	—	:1

MAXIMUM RATINGS

Parameter	Ratings
Operating Temperature	-40 °C to +85 °C
Storage Temperature	-65 °C to +150 °C
Input Power (as a splitter)	1.5 W max.
Internal Dissipation	0.75W max.

Permanent damage may occur if any of these limits are exceeded.

ELECTRICAL SCHEMATIC





SURFACE MOUNT

Power Splitter/Combiner

SP-2U2+

2 Way-0° 50Ω 1720 to 2850 MHz

PIN CONNECTIONS

SUM PORT	5
PORT 1	1
PORT 2	3
GROUND	2,4,6

PRODUCT MARKING: N/A

DEMOBOARD MCL P/N: TB-374
SUGGESTED PCB LAYOUT (PL-232)

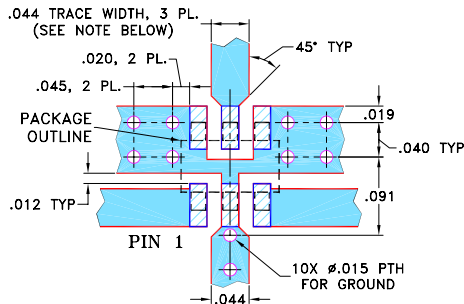

- NOTES:**
- TRACE WIDTH IS SHOWN FOR ROGERS R04350B WITH DIELECTRIC THICKNESS .020" ± .0015"; COPPER: 1/2 OZ. EACH SIDE. FOR OTHER MATERIALS TRACE WIDTH MAY NEED TO BE MODIFIED.
 - BOTTOM SIDE OF THE PCB IS CONTINUOUS GROUND PLANE.

- DENOTES PCB COPPER LAYOUT WITH SMOBC (SOLDER MASK OVER BARE COPPER)
- DENOTES COPPER LAND PATTERN FREE OF SOLDER MASK

OUTLINE DRAWING

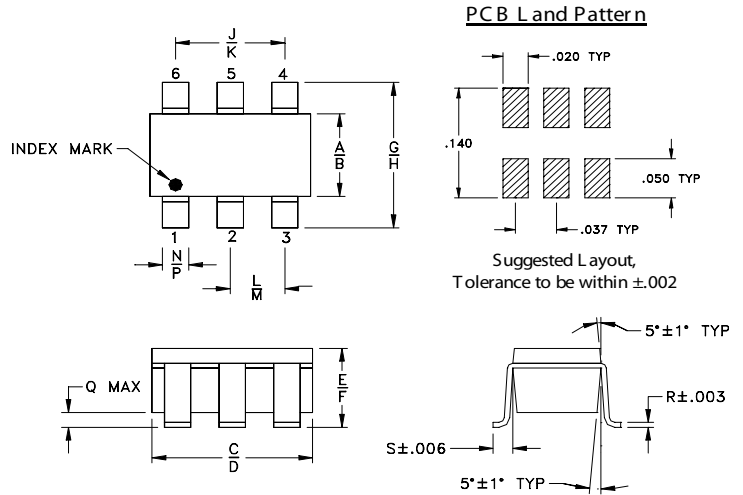

OUTLINE DIMENSIONS (Inch/mm)

A	B	C	D	E	F	G	H	J
.052	.067	.106	.122	.035	.064	.087	.118	.067
1.32	1.70	2.69	3.10	0.89	1.63	2.21	3.00	1.70
K	L	M	N	P	Q	R	S	wt
.083	.033	.042	.012	.020	.012	.006	.018	grams
2.11	0.84	1.07	0.30	0.51	0.30	0.15	0.46	0.020

TAPE & REEL INFORMATION: F31



SURFACE MOUNT

Power Splitter/Combiner

SP-2U2+

2 Way-0° 50Ω 1720 to 2850 MHz

TYPICAL PERFORMANCE DATA AND CHARTS

Frequency (MHz)	Total Loss ¹ (dB)		Amplitude Unbalance (dB)	Isolation (dB)	Phase Unbalance (deg.)	VSWR (:1)		
	S-1	S-2				S	1	2
1720.00	3.45	3.47	0.02	11.30	0.66	1.40	1.27	1.27
1800.00	3.44	3.47	0.02	12.57	0.68	1.36	1.21	1.21
1900.00	3.44	3.46	0.02	14.52	0.66	1.32	1.14	1.14
2000.00	3.44	3.46	0.02	17.04	0.62	1.29	1.07	1.07
2100.00	3.45	3.47	0.02	20.47	0.74	1.27	1.01	1.01
2200.00	3.47	3.49	0.02	25.19	0.73	1.27	1.07	1.06
2300.00	3.50	3.52	0.02	27.51	0.73	1.30	1.14	1.13
2400.00	3.55	3.56	0.01	22.99	0.75	1.36	1.21	1.20
2460.00	3.58	3.60	0.02	20.48	0.81	1.41	1.26	1.25
2500.00	3.61	3.63	0.02	19.05	0.83	1.45	1.29	1.28
2550.00	3.65	3.67	0.02	17.52	0.83	1.50	1.33	1.32
2600.00	3.70	3.72	0.02	16.23	0.82	1.56	1.36	1.35
2700.00	3.81	3.84	0.02	14.07	0.84	1.72	1.44	1.43
2800.00	3.97	3.99	0.02	12.36	0.85	1.90	1.51	1.50
2850.00	4.06	4.08	0.02	11.61	0.80	2.00	1.55	1.54

1. Total Loss = Insertion Loss + 3dB splitter loss.

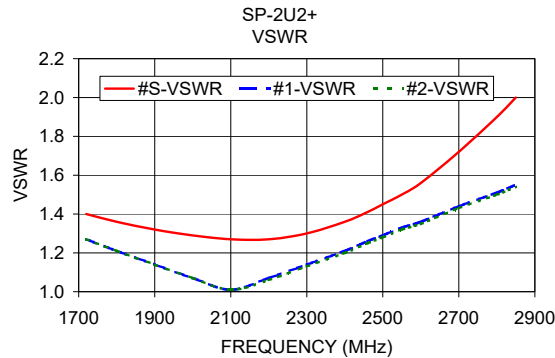
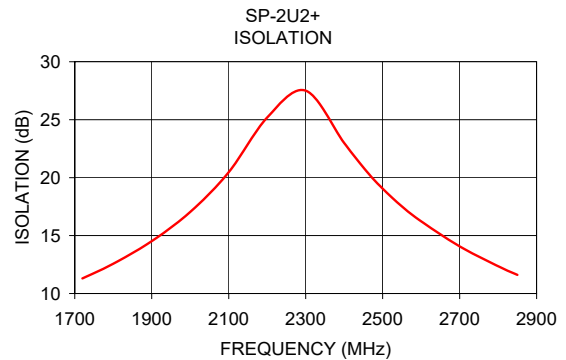
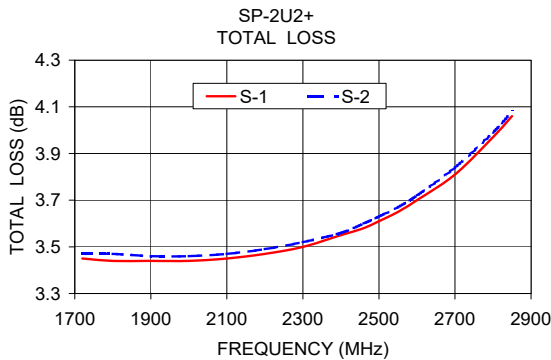

ESD Rating

Human Body Model (HBM): Class 1A (250 v to <500 v) in accordance with ANSI/ESD STM 5.1 - 2001
Machine Model (MM): Class M1 (< 100 v) in accordance with ANSI/ESD STM 5.2 - 1999 (pass 50V)

NOTES

- A. Performance and quality attributes and conditions not expressly stated in this specification document are intended to be excluded and do not form a part of this specification document.
- B. Electrical specifications and performance data contained in this specification document are based on Mini-Circuit's applicable established test performance criteria and measurement instructions.
- C. The parts covered by this specification document are subject to Mini-Circuits standard limited warranty and terms and conditions (collectively, "Standard Terms"); Purchasers of this part are entitled to the rights and benefits contained therein. For a full statement of the standard terms and the exclusive rights and remedies thereunder, please visit Mini-Circuits' website at www.minicircuits.com/terms/viewterm.html



2 Way-0° Power Splitter/Combiner

SP-2U2+

Typical Performance Data

TEST CONDITIONS: INPUT POWER = 0dBm @Temperature = +25°C

FREQ. (MHz)	TOTAL LOSS ¹ (dB)		AMP. UNBAL. (dB)	PHASE UNBAL. (deg.)	ISOLATION (dB)	VSWR (:1)		
	S-1	S-2				S	1	2
1720	3.44	3.4	0.04	0.28	11.12	1.36	1.33	1.29
1804	3.42	3.39	0.03	0.32	12.39	1.33	1.26	1.23
1900	3.41	3.40	0.01	0.35	14.19	1.29	1.18	1.16
1954	3.41	3.40	0.01	0.39	15.39	1.28	1.14	1.12
2002	3.41	3.41	0.00	0.43	16.61	1.27	1.11	1.09
2050	3.42	3.42	0.00	0.44	17.99	1.27	1.07	1.05
2100	3.42	3.43	0.01	0.51	19.63	1.28	1.05	1.02
2152	3.44	3.44	0.00	0.60	21.57	1.29	1.05	1.02
2182	3.45	3.46	0.01	0.60	22.72	1.31	1.06	1.04
2188	3.45	3.46	0.01	0.61	22.94	1.31	1.07	1.04
2194	3.45	3.46	0.01	0.62	23.16	1.31	1.07	1.05
2200	3.45	3.46	0.01	0.64	23.38	1.31	1.08	1.05
2206	3.45	3.47	0.02	0.64	23.59	1.32	1.08	1.06
2212	3.46	3.47	0.01	0.66	23.80	1.32	1.08	1.06
2218	3.46	3.47	0.01	0.68	23.99	1.32	1.09	1.06
2224	3.46	3.47	0.01	0.68	24.18	1.33	1.09	1.07
2230	3.46	3.48	0.02	0.69	24.34	1.33	1.10	1.07
2236	3.47	3.48	0.01	0.68	24.47	1.33	1.10	1.08
2242	3.47	3.48	0.01	0.70	24.61	1.34	1.10	1.08
2248	3.47	3.48	0.01	0.71	24.72	1.34	1.11	1.09
2254	3.47	3.49	0.02	0.73	24.82	1.34	1.11	1.09
2260	3.48	3.49	0.01	0.74	24.90	1.35	1.12	1.09
2266	3.48	3.49	0.01	0.75	24.97	1.35	1.12	1.10
2272	3.48	3.50	0.02	0.75	24.98	1.36	1.13	1.10
2278	3.49	3.50	0.01	0.76	25.00	1.36	1.13	1.11
2284	3.49	3.50	0.01	0.76	24.99	1.37	1.14	1.11
2290	3.49	3.50	0.01	0.78	24.93	1.37	1.14	1.12
2296	3.50	3.51	0.01	0.77	24.88	1.37	1.15	1.12
2300	3.50	3.51	0.01	0.77	24.83	1.38	1.15	1.12
2308	3.50	3.52	0.02	0.81	24.68	1.38	1.16	1.13
2314	3.51	3.52	0.01	0.82	24.54	1.39	1.16	1.14
2320	3.51	3.52	0.01	0.83	24.39	1.39	1.17	1.14
2326	3.51	3.52	0.01	0.84	24.22	1.40	1.17	1.14
2332	3.52	3.53	0.01	0.83	24.05	1.40	1.18	1.15
2338	3.52	3.53	0.01	0.85	23.87	1.41	1.18	1.15
2344	3.52	3.54	0.02	0.86	23.68	1.41	1.19	1.16
2350	3.53	3.54	0.01	0.89	23.48	1.42	1.19	1.16
2356	3.53	3.55	0.02	0.90	23.27	1.42	1.20	1.17
2362	3.54	3.55	0.01	0.89	23.05	1.43	1.20	1.17
2368	3.54	3.55	0.01	0.90	22.83	1.43	1.21	1.18
2374	3.55	3.56	0.01	0.91	22.61	1.44	1.21	1.18
2380	3.55	3.56	0.01	0.90	22.39	1.45	1.22	1.19
2386	3.56	3.57	0.01	0.91	22.16	1.45	1.22	1.19
2392	3.56	3.57	0.01	0.92	21.94	1.46	1.23	1.20
2398	3.56	3.58	0.02	0.95	21.72	1.47	1.23	1.20
2404	3.57	3.58	0.01	0.96	21.49	1.47	1.24	1.21
2452	3.61	3.62	0.01	1.03	19.77	1.53	1.28	1.25
2500	3.66	3.66	0.00	1.10	18.25	1.59	1.32	1.29
2554	3.72	3.72	0.00	1.16	16.76	1.66	1.37	1.33
2602	3.78	3.78	0.00	1.28	15.59	1.74	1.42	1.38
2650	3.85	3.85	0.00	1.33	14.57	1.82	1.46	1.42
2704	3.93	3.93	0.00	1.37	13.55	1.92	1.52	1.46
2800	4.12	4.11	0.01	1.50	11.98	2.13	1.61	1.55
2854	4.23	4.22	0.01	1.56	11.23	2.27	1.66	1.59

¹Total Loss = Insertion Loss+ 3dB Splitter Loss

REV. X2
SP-2U2+
100627

Page 1 of 3



IR/RF MICROWAVE COMPONENTS • ISO 9001 ISO 14001 AS 9100 CERTIFIED RoHS compliant
P.O. Box 350166, Brooklyn, New York 11235-0006 (718) 934-4500 Fax (718) 332-4661



The Design Engineers Search Engine finds the model you need, Instantly • For detailed performance specs & shopping online see



2 Way-0° Power Splitter/Combiner

SP-2U2+

Typical Performance Data

TEST CONDITIONS: INPUT POWER = 0dBm @Temperature = -40°C

FREQ. (MHz)	TOTAL LOSS ¹ (dB)		AMP. UNBAL. (dB)	PHASE UNBAL. (deg.)	ISOLATION (dB)	VSWR (:1)		
	S-1	S-2				S	1	2
1720	3.26	3.22	0.04	0.57	10.69	1.38	1.33	1.29
1804	3.24	3.22	0.02	0.62	11.90	1.36	1.26	1.22
1900	3.23	3.22	0.01	0.66	13.60	1.33	1.17	1.15
1954	3.22	3.21	0.01	0.73	14.72	1.32	1.13	1.10
2002	3.23	3.21	0.02	0.70	15.88	1.32	1.10	1.06
2050	3.23	3.22	0.01	0.67	17.18	1.32	1.07	1.03
2100	3.23	3.22	0.01	0.74	18.68	1.32	1.05	1.02
2152	3.24	3.23	0.01	0.78	20.47	1.34	1.05	1.06
2182	3.25	3.24	0.01	0.74	21.56	1.34	1.07	1.08
2188	3.25	3.25	0.00	0.77	21.76	1.34	1.07	1.08
2194	3.25	3.25	0.00	0.75	21.96	1.35	1.08	1.09
2200	3.24	3.25	0.01	0.77	22.16	1.35	1.08	1.09
2206	3.25	3.25	0.00	0.78	22.36	1.35	1.09	1.10
2212	3.25	3.26	0.01	0.81	22.57	1.35	1.09	1.10
2218	3.25	3.25	0.00	0.84	22.75	1.36	1.09	1.10
2224	3.25	3.26	0.01	0.83	22.93	1.36	1.10	1.11
2230	3.25	3.26	0.01	0.82	23.08	1.36	1.10	1.11
2236	3.26	3.26	0.00	0.84	23.21	1.37	1.11	1.12
2242	3.26	3.27	0.01	0.84	23.32	1.37	1.11	1.12
2248	3.26	3.27	0.01	0.85	23.44	1.37	1.12	1.13
2254	3.26	3.27	0.01	0.89	23.55	1.38	1.12	1.13
2260	3.26	3.28	0.02	0.88	23.63	1.38	1.13	1.14
2266	3.26	3.28	0.02	0.88	23.72	1.38	1.13	1.14
2272	3.27	3.28	0.01	0.89	23.77	1.39	1.13	1.14
2278	3.27	3.28	0.01	0.91	23.81	1.39	1.14	1.15
2284	3.27	3.28	0.01	0.90	23.83	1.40	1.14	1.15
2290	3.27	3.29	0.02	0.91	23.80	1.40	1.15	1.16
2296	3.28	3.29	0.01	0.91	23.79	1.40	1.15	1.17
2300	3.28	3.29	0.01	0.92	23.76	1.41	1.16	1.17
2308	3.28	3.30	0.02	0.94	23.67	1.41	1.16	1.17
2314	3.28	3.30	0.02	0.96	23.59	1.42	1.17	1.18
2320	3.29	3.30	0.01	0.97	23.50	1.42	1.17	1.18
2326	3.29	3.31	0.02	0.96	23.39	1.42	1.18	1.19
2332	3.29	3.31	0.02	0.96	23.27	1.43	1.19	1.19
2338	3.29	3.32	0.03	0.98	23.14	1.43	1.19	1.20
2344	3.30	3.32	0.02	0.99	22.99	1.44	1.20	1.20
2350	3.30	3.32	0.02	1.00	22.84	1.44	1.20	1.21
2356	3.30	3.33	0.03	1.02	22.67	1.45	1.21	1.21
2362	3.31	3.33	0.02	1.04	22.50	1.45	1.22	1.22
2368	3.31	3.33	0.02	1.04	22.31	1.46	1.22	1.22
2374	3.31	3.34	0.03	1.03	22.12	1.46	1.23	1.23
2380	3.31	3.34	0.03	1.04	21.94	1.47	1.23	1.23
2386	3.32	3.34	0.02	1.05	21.75	1.47	1.24	1.24
2392	3.32	3.35	0.03	1.06	21.55	1.48	1.24	1.24
2398	3.32	3.35	0.03	1.09	21.36	1.48	1.25	1.25
2404	3.33	3.36	0.03	1.11	21.15	1.49	1.25	1.25
2452	3.35	3.38	0.03	1.21	19.55	1.53	1.29	1.28
2500	3.39	3.42	0.03	1.29	18.09	1.58	1.33	1.32
2554	3.44	3.47	0.03	1.37	16.62	1.65	1.38	1.37
2602	3.48	3.52	0.04	1.57	15.42	1.71	1.43	1.40
2650	3.54	3.56	0.02	1.67	14.38	1.78	1.46	1.42
2704	3.61	3.64	0.03	1.82	13.33	1.87	1.51	1.45
2800	3.77	3.78	0.01	2.00	11.70	2.06	1.59	1.50
2854	3.84	3.87	0.03	2.14	10.91	2.18	1.61	1.53

¹ Total Loss = Insertion Loss+ 3dB Splitter Loss

REV. X2
SP-2U2+
100627

Page 2 of 3



IR/RF MICROWAVE COMPONENTS • ISO 9001 ISO 14001 AS 9100 CERTIFIED RoHS compliant
P.O. Box 350166, Brooklyn, New York 11235-0006 (718) 934-4500 Fax (718) 332-4661



The Design Engineers Search Engine finds the model you need, Instantly • For detailed performance specs & shopping online see



2 Way-0° Power Splitter/Combiner

SP-2U2+

Typical Performance Data

TEST CONDITIONS: INPUT POWER = 0dBm @Temperature = +85°C

FREQ. (MHz)	TOTAL LOSS ¹ (dB)		AMP. UNBAL. (dB)	PHASE UNBAL. (deg.)	ISOLATION (dB)	VSWR (:1)		
	S-1	S-2				S	1	2
1720	3.53	3.47	0.06	0.20	11.47	1.34	1.34	1.29
1804	3.51	3.47	0.04	0.24	12.82	1.29	1.27	1.24
1900	3.50	3.48	0.02	0.25	14.71	1.25	1.20	1.18
1954	3.49	3.48	0.01	0.33	15.98	1.23	1.16	1.15
2002	3.50	3.49	0.01	0.40	17.29	1.22	1.12	1.12
2050	3.50	3.51	0.01	0.44	18.76	1.22	1.09	1.09
2100	3.51	3.52	0.01	0.54	20.55	1.23	1.06	1.06
2152	3.53	3.54	0.01	0.66	22.70	1.24	1.05	1.03
2182	3.54	3.55	0.01	0.70	24.00	1.26	1.05	1.01
2188	3.54	3.55	0.01	0.71	24.24	1.26	1.05	1.01
2194	3.54	3.55	0.01	0.72	24.48	1.26	1.06	1.01
2200	3.55	3.56	0.01	0.74	24.70	1.27	1.06	1.01
2206	3.55	3.56	0.01	0.74	24.93	1.27	1.06	1.01
2212	3.55	3.57	0.02	0.78	25.14	1.27	1.07	1.01
2218	3.56	3.57	0.01	0.81	25.35	1.28	1.07	1.01
2224	3.56	3.57	0.01	0.79	25.55	1.28	1.07	1.02
2230	3.56	3.57	0.01	0.81	25.71	1.29	1.08	1.02
2236	3.57	3.58	0.01	0.81	25.83	1.29	1.08	1.03
2242	3.57	3.58	0.01	0.82	25.94	1.30	1.08	1.03
2248	3.57	3.59	0.02	0.83	26.03	1.30	1.09	1.03
2254	3.57	3.59	0.02	0.86	26.08	1.30	1.09	1.04
2260	3.58	3.59	0.01	0.87	26.10	1.31	1.10	1.04
2266	3.58	3.59	0.01	0.89	26.13	1.31	1.10	1.05
2272	3.59	3.60	0.01	0.89	26.10	1.32	1.11	1.05
2278	3.59	3.60	0.01	0.91	26.07	1.32	1.11	1.05
2284	3.59	3.60	0.01	0.89	26.01	1.33	1.11	1.06
2290	3.60	3.60	0.00	0.91	25.91	1.33	1.12	1.06
2296	3.60	3.61	0.01	0.92	25.79	1.34	1.12	1.07
2300	3.60	3.61	0.01	0.92	25.68	1.34	1.13	1.07
2308	3.61	3.62	0.01	0.95	25.43	1.35	1.13	1.08
2314	3.62	3.62	0.00	0.97	25.23	1.35	1.14	1.08
2320	3.62	3.63	0.01	0.98	25.01	1.36	1.14	1.08
2326	3.63	3.63	0.00	0.99	24.80	1.36	1.15	1.09
2332	3.63	3.63	0.00	0.99	24.59	1.37	1.15	1.09
2338	3.63	3.64	0.01	1.00	24.37	1.37	1.16	1.10
2344	3.64	3.64	0.00	1.01	24.15	1.38	1.16	1.10
2350	3.64	3.65	0.01	1.03	23.91	1.39	1.17	1.11
2356	3.65	3.66	0.01	1.05	23.64	1.39	1.17	1.11
2362	3.65	3.66	0.01	1.07	23.38	1.40	1.18	1.12
2368	3.66	3.66	0.00	1.06	23.12	1.41	1.18	1.12
2374	3.67	3.67	0.00	1.08	22.87	1.41	1.19	1.12
2380	3.67	3.67	0.00	1.08	22.63	1.42	1.19	1.13
2386	3.68	3.68	0.00	1.09	22.39	1.43	1.20	1.13
2392	3.68	3.68	0.00	1.10	22.15	1.43	1.20	1.14
2398	3.69	3.68	0.01	1.12	21.92	1.44	1.21	1.15
2404	3.70	3.69	0.01	1.13	21.68	1.45	1.22	1.15
2452	3.75	3.74	0.01	1.22	19.87	1.51	1.26	1.19
2500	3.81	3.79	0.02	1.29	18.32	1.58	1.31	1.23
2554	3.88	3.85	0.03	1.32	16.84	1.67	1.36	1.28
2602	3.96	3.92	0.04	1.42	15.69	1.75	1.41	1.33
2650	4.05	4.00	0.05	1.43	14.67	1.85	1.46	1.38
2704	4.16	4.10	0.06	1.43	13.68	1.96	1.52	1.44
2800	4.37	4.31	0.06	1.39	12.17	2.20	1.62	1.56
2854	4.49	4.43	0.06	1.39	11.44	2.35	1.68	1.62

¹ Total Loss = Insertion Loss+ 3dB Splitter Loss



Typical Performance Curves

Total Loss

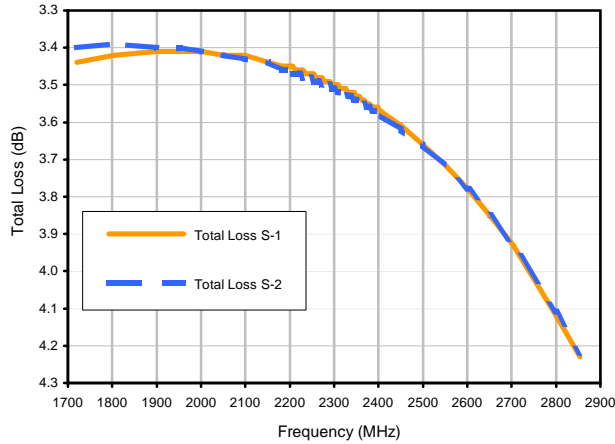

Total Loss S-1 vs. TEMPERATURE

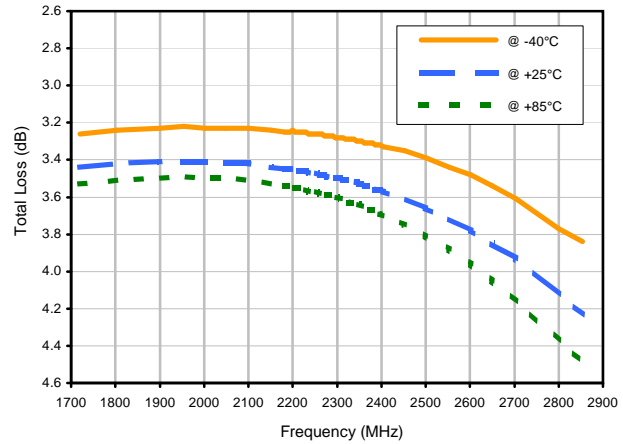

Amplitude Unbalance vs. TEMPERATURE

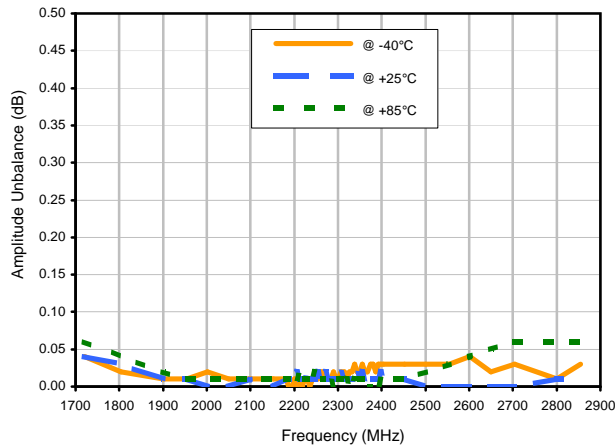

Phase Unbalance vs. TEMPERATURE

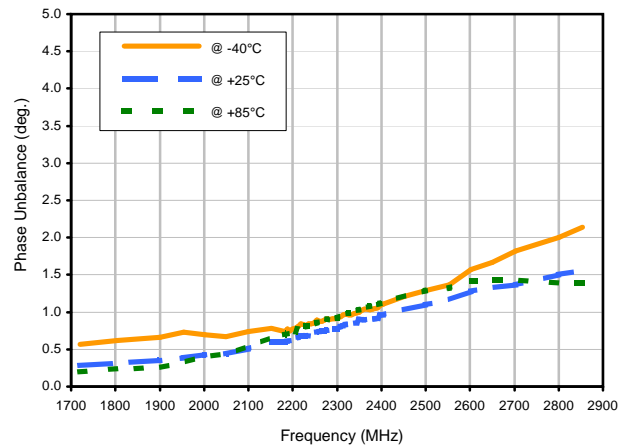

Isolation 1-2 vs. TEMPERATURE

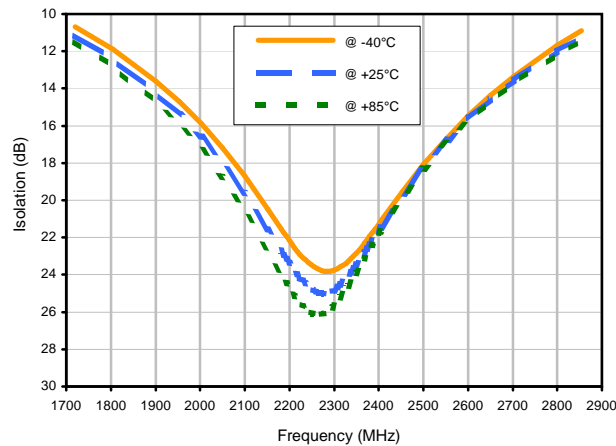

REV. X2
 SP-2U2+
 100627
 Page 1 of 2



RF/MICROWAVE COMPONENTS • ISO 9001 ISO 14001 AS 9100 CERTIFIED • RoHS compliant
 P.O. Box 350166, Brooklyn, New York 11235-0006 (718) 934-4500 Fax (718) 332-4661



The Design Engineers Search Engine finds the model you need, instantly • For detailed performance specs & shopping online see



Typical Performance Curves

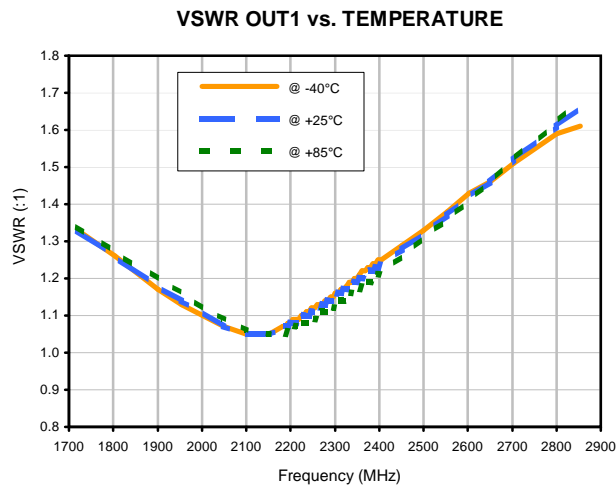
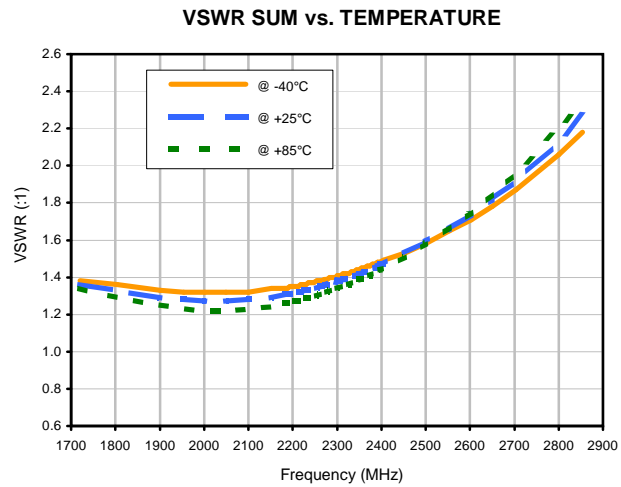
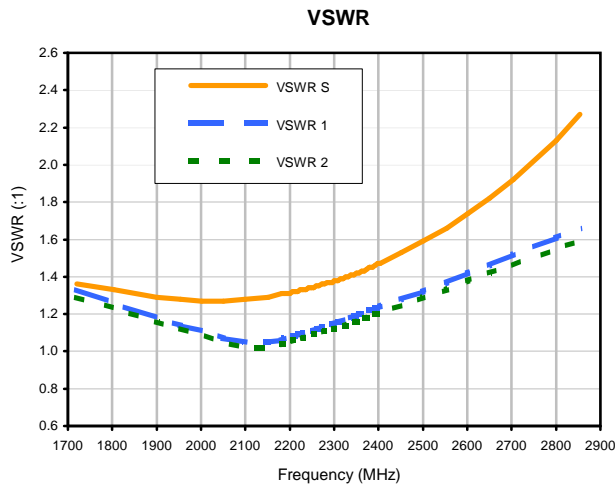

Outline Dimensions

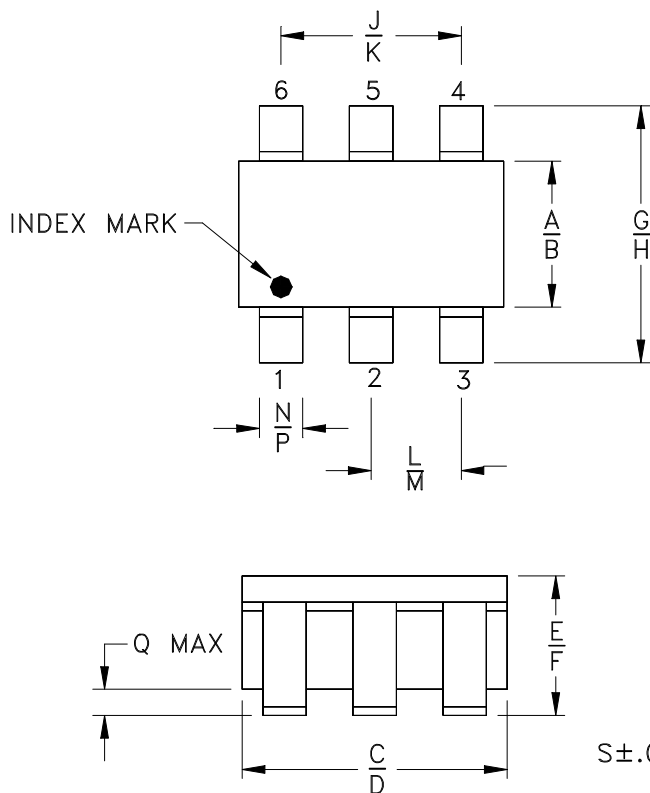

PCB Land Pattern

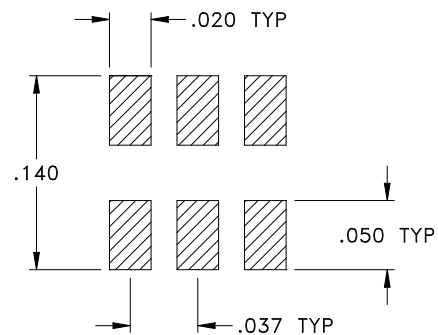

Suggested Layout,
Tolerance to be within $\pm .002$

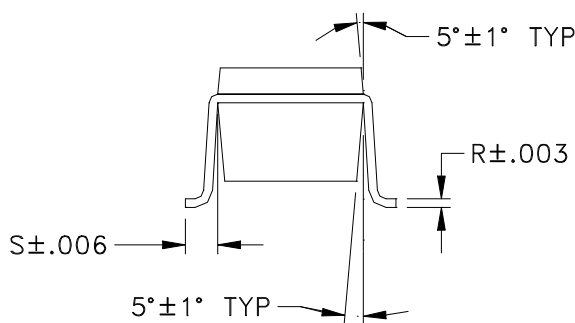

CASE #	A	B	C	D	E	F	G	H	J	K
CA531	.052 (1.32)	.067 (1.70)	.106 (2.69)	.122 (3.10)	.035 (0.89)	.064 (1.63)	.087 (2.21)	.118 (3.00)	.067 (1.70)	.083 (2.11)

CASE #	L	M	N	P	Q	R	S	WT. GRAM
CA531	.033 (0.84)	.042 (1.07)	.012 (0.30)	.020 (0.51)	.012 (0.30)	.006 (0.15)	.018 (0.46)	.020

Dimensions are in inches (mm). Tolerances: 2Pl. $\pm .01$; 3Pl. $\pm .005$

Notes:

- Case material: Plastic.
- Termination finish:
For RoHS Case Styles: Tin-Silver alloy plate over Nickel barrier.
(Unless stated otherwise on Data sheet).



INTERNET <http://www.minicircuits.com>

P.O. Box 350166, Brooklyn, New York 11235-0003 (718) 934-4500 Fax (718) 332-4661

Distribution Centers NORTH AMERICA 800-654-7949 • 417-335-5935 • Fax 417-335-5945 • EUROPE 44-1252-832600 • Fax 44-1252-837010

Mini-Circuits ISO 9001 & ISO 14001 Certified

Tape & Reel Packaging TR-F31

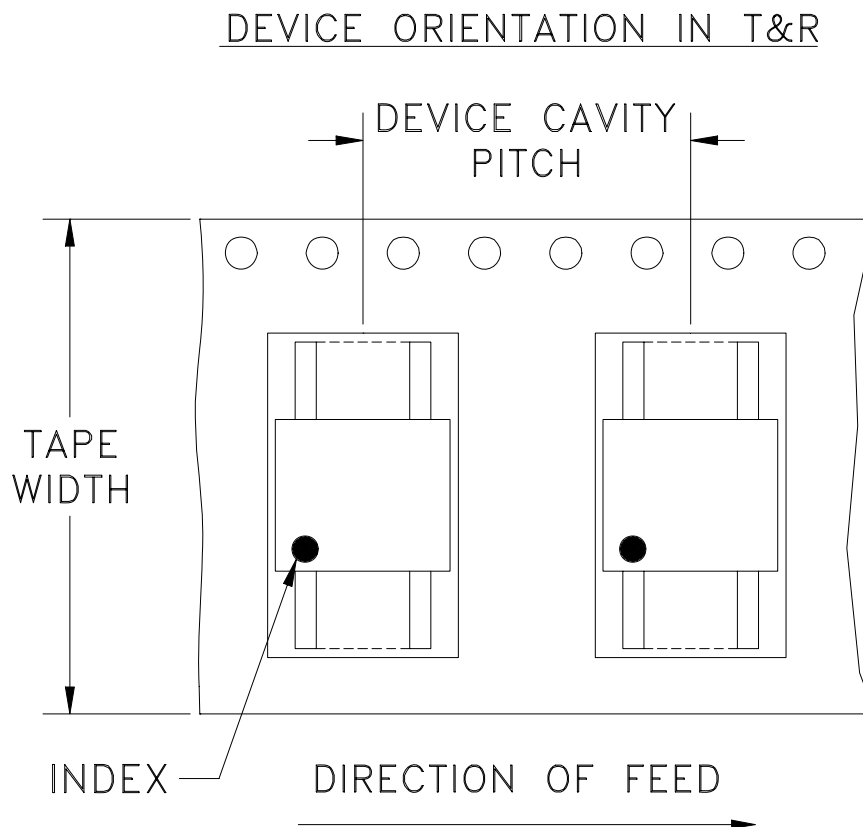

Tape Width, mm	Device Cavity Pitch, mm	Reel Size, inches	Devices per Reel	
8	4	7	Small quantity standards (see note)	20
				50
				100
				200
			Standard	1000

Note: Please Consult individual model data sheet to determine device per reel availability

Mini-Circuits carrier tape materials provide protection from ESD (Electro-Static Discharge) during handling and transportation. Tapes are static dissipative and comply with industry standards EIA-481/EIA-541.

Go to: www.minicircuits.com/pages/pdfs/tape.pdf



INTERNET <http://www.minicircuits.com>

P.O. Box 350166, Brooklyn, New York 11235-0003 (718) 934-4500 Fax (718) 332-4661

Distribution Centers NORTH AMERICA 800-654-7949 • 417-335-5935 • Fax 417-335-5945 • EUROPE 44-1252-832600 • Fax 44-1252-837010

Mini-Circuits ISO 9001 & ISO 14001 Certified

THIRD ANGLE PROJECTION

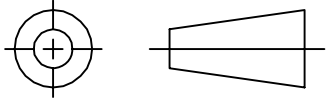

REVISIONS

REV OR	ECN No.	DESCRIPTION	DATE	DR	AUTH
	M102559	NEW RELEASE	02/23/06	MMG	HY

SUGGESTED MOUNTING CONFIGURATION FOR CA531 CASE STYLE, "jk" PIN CONNECTION

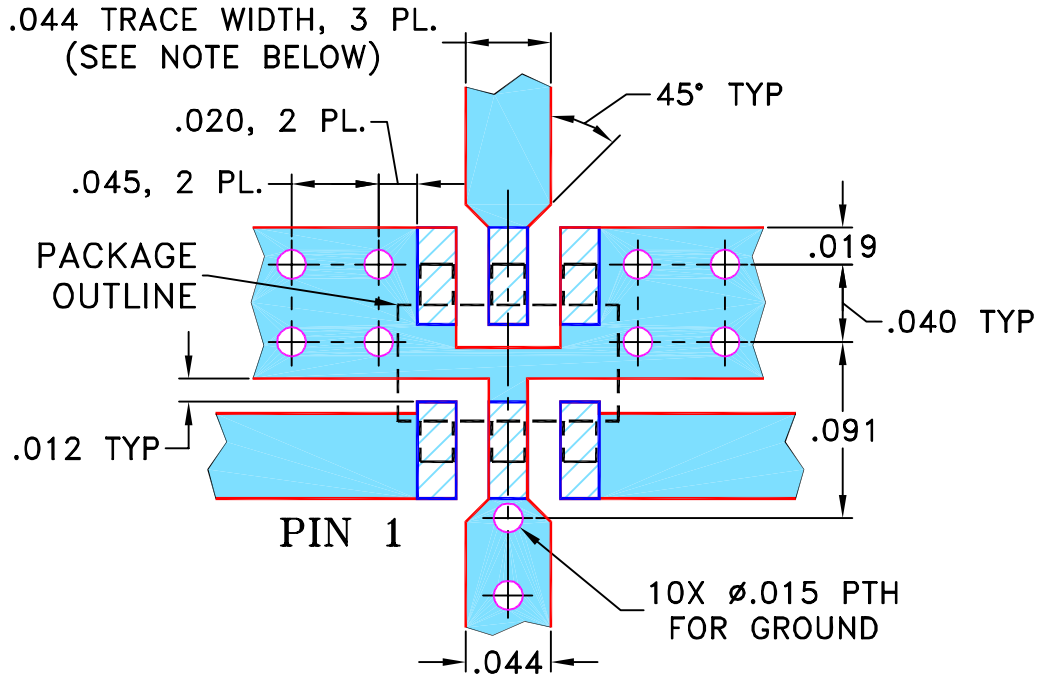

- NOTES:** 1. TRACE WIDTH IS SHOWN FOR ROGERS RO4350B WITH DIELECTRIC THICKNESS .020" ± .0015"; COPPER: 1/2 OZ. EACH SIDE. FOR OTHER MATERIALS TRACE WIDTH MAY NEED TO BE MODIFIED.
 2. BOTTOM SIDE OF THE PCB IS CONTINUOUS GROUND PLANE.



DENOTES PCB COPPER LAYOUT WITH SMOBC (SOLDER MASK OVER BARE COPPER)

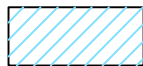

DENOTES COPPER LAND PATTERN FREE OF SOLDER MASK

UNLESS OTHERWISE SPECIFIED	INITIALS	DATE
DIMENSIONS ARE IN INCHES	DRAWN MMG	02/22/06
TOLERANCES ON:	CHECKED AV	02/23/06
2 PL DECIMALS ±	APPROVED HY	02/23/06
3 PL DECIMALS ± .005		
ANGLES ±		
FRACTIONS ±		



Mini-Circuits®

13 Neptune Avenue
Brooklyn NY 11235

PL, jk, CA531, SP-2C+ (P+, U+), TB-374

Mini-Circuits®
 THIS DOCUMENT AND ITS CONTENTS ARE THE PROPERTY OF MINI-CIRCUITS. EXCEPT FOR USE EXPRESSLY GRANTED, IN WRITING, TO ITS VENDORS, VENDEE AND THE UNITED STATES GOVERNMENT, MINI-CIRCUITS RESERVES ALL PROPRIETARY DESIGN, USE, MANUFACTURING AND REPRODUCTION RIGHTS THERE TO. THESE CONTENTS SHALL NOT BE USED, DUPLICATED OR DISCLOSED TO ANY OUTSIDE PARTY, IN WHOLE OR IN PART, WITHOUT WRITTEN PERMISSION OF MINI-CIRCUITS.
 ASHEETA1.DWG REV:A DATE:01/12/95

SIZE	CODE IDENT	DRAWING NO:	REV:
A	15542	98-PL-232	OR
FILE:	98PL232	SCALE: 10:1	SHEET: 1 OF 1

Evaluation Board and Circuit

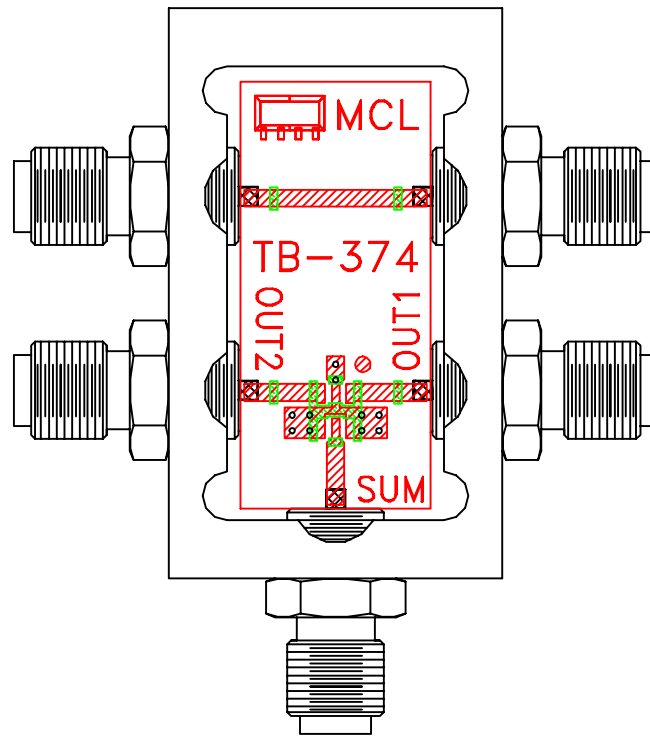

TB-374

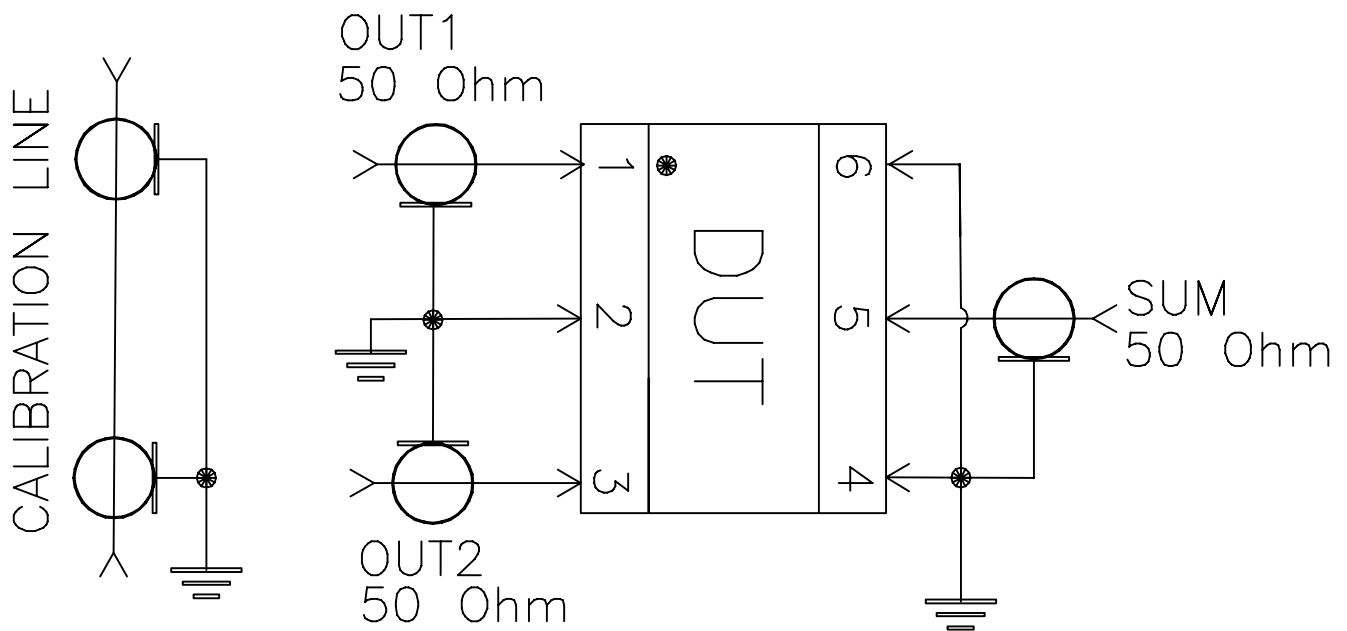

Schematic Diagram

Notes:

1. 50 Ohm SMA Female connectors.
2. PCB Material: Rogers R04350B or its equivalent, Dielectric Constant=3.5, Thickness=.020"

 Mini-Circuits®

All Mini-Circuits products are manufactured under exacting quality assurance and control standards, and are capable of meeting published specifications after being subjected to any or all of the following physical and environmental test.

Specification	Test/Inspection Condition	Reference/Spec
Operating Temperature	-40° to 85° C Ambient Environment	Individual Model Data Sheet
Storage Temperature	-65° to 150° C Ambient Environment	Individual Model Data Sheet
Autoclave	15 psig, 100% RH, 121°C, 96 hours	JESD22-A102-C, Condition C
Temperature Cycling	-65° to 150°C, 100 cycles	JESD22-A104
Temperature Humidity	85°C/ 85% RH, 168 hours	JESD22-113
Solder Reflow Heat	Sn-Pb Eutetic Process: 240°C peak Pb-Free Process: 260°C peak	J-STD-020, Table 4-1, 4-2 and 5-2; Figure 5-1
Moisture Sensitivity: Level 1	Bake at 125°C for 24 hours Soak at 85°C/85% RH for 168 hours, Reflow 3 cycles at 240°C peak (Non-RoHS) or 260°C (RoHS)	J-STD-020
Solderability	10X magnification, 95% coverage	JESD22-B102, Method 1: Dip and Look Test
Mechanical Shock	50g, 11 ms, 1/2-sine, 18 shocks: 3 each direction, each of 3 axes	MIL-STD-202, Method 213, Condition A
Vibration (High Frequency)	20g peak, 10-2000 Hz, 12 times in each of three perpendicular directions (total 36)	MIL-STD-202, Method 204, Condition D