



# Super-Flexible Test Cable

## SLC-6FT-SMSM+

Mini-Circuits

50Ω 6FT DC to 18 GHz SMA-Male

### THE BIG DEAL

- Super Flexible design for easy connections & bend radius
- Double shield cable for excellent shielding effectiveness
- Stainless steel straight SMA connectors for long mating-cycle life
- 6 month guarantee\*



Generic photo used for illustration purposes only

<b>Model No.</b>	SLC-6FT-SMSM+
<b>Case Style</b>	PH2043-6
<b>Connectors</b>	SMA-Male

### APPLICATIONS

- Test and Measurement
- Research & Development labs
- Environmental & Temperature Test Chambers
- Field RF testing

#### +RoHS Compliant

The +Suffix identifies RoHS Compliance. See our website for methodologies and qualifications

#### Product Guarantee\*

Mini-Circuits' will repair or replace your test cable at its option if the connector attachment fails within six months of shipment. This guarantee excludes cable or connector interface damage from misuse or abuse.

### PRODUCT OVERVIEW

Mini-Circuits' SLC-SMSM+ Series are super-flexible cables which provide wideband performance from DC to 18 GHz with low insertion loss and excellent VSWR. The cable is designed for stability of phase and amplitude versus flexure while offering tremendous durability and reliability. Its unique construction of a double shielded cable allows the cable to have the greatest of flexibility and yet handle the demanding lab environments where constant bending and flexing are required. In addition, they feature straight SMA to straight SMA stainless steel connectors. Available from stock in a variety of lengths to support many different requirements.

### KEY FEATURES

Feature	Advantages
Super-Flexible 0.25 inch static bend radius	Supports a wide range of test applications including R&D, military and defense, production test and more.
Excellent stability of phase and insertion loss versus flexure	SLC-SMSM+ Series test cables have been tested in bend radii as tight as 2.4 inches to qualify minimal change in insertion loss, insertion phase, and VSWR, providing reliable performance in a wide range of configurations.
Performance qualified to 100,000 flexures	Like all Mini-Circuits test cables, SLC-SMSM+ series models have been performance qualified up to 100,000 bend cycles, ensuring outstanding durability and extra long life.

REV. A  
ECO-019949  
SLC-6FT-SMSM+  
MCL NY  
231110





# Super-Flexible Test Cable

## SLC-6FT-SMSM+

Mini-Circuits

50Ω 6FT DC to 18 GHz SMA-Male

### ELECTRICAL SPECIFICATIONS AT +25°C

Parameter	Frequency (GHz)	Min.	Typ.	Max.	Units
Frequency Range		DC		18	GHz
Length <sup>1</sup>		6			FT
Insertion Loss	DC - 1	—	1.6	2.6	dB
	1 - 2	—	2.7	3.6	
	2 - 4	—	3.9	5.0	
	4 - 10	—	6.0	8.0	
	10 - 18	—	8.8	10.9	
Return Loss	DC - 6	17.7	34.1	—	dB
	6 - 18	16.5	29.9	—	

1. Custom sizes available, consult factory.

### PERFORMANCE CHANGE VS. FLEXURE (TYPICAL)<sup>2</sup>

Parameter	Frequency (GHz)	Bend Radius (inches)			Units
		10.0	3.25	2.40	
Insertion Loss <sup>3</sup>	DC - 1	0.003	0.002	0.005	dB
	1 - 2	0.003	0.002	0.005	
	2 - 4	0.002	0.001	0.005	
	4 - 10	0.003	0.005	0.016	
	10 - 18	0.005	0.059	0.102	
Insertion Phase <sup>3</sup>	DC - 1	0.05	0.13	0.18	Deg
	1 - 2	0.11	0.27	0.38	
	2 - 4	0.22	0.53	0.76	
	4 - 10	0.56	1.33	1.93	
	10 - 18	1.00	2.26	3.18	
VSWR <sup>3</sup>	DC - 6	0.002	0.005	0.01	:1
	6 - 18	0.005	0.017	0.028	

2. Performance change versus flexure with a 3 ft cable 360° around a 4" diameter mandrel.

3. Absolute values normalized to the reference position 0. See [AN-46-003](#) under Associated Application Notes

### ABSOLUTE MAXIMUM RATINGS

Parameter	Ratings
Operating Temperature	-55°C to +125°C
Storage Temperature	-55°C to +125°C
Power Handling at 25°C	39.5 W Max at 1 GHz
	28.4 W Max at 2 GHz
	22 W Max at 4 GHz
	11.8 W Max at 10 GHz
	18 W Max at 18 GHz

Permanent damage may occur if any of these limits are exceeded.





# Super-Flexible Test Cable

## SLC-6FT-SMSM+

Mini-Circuits

50Ω 6FT DC to 18 GHz SMA-Male

### CABLE CONSTRUCTION

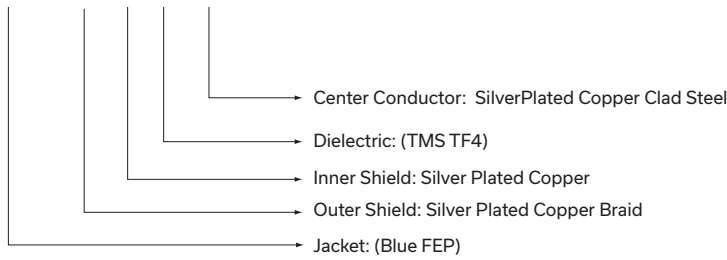
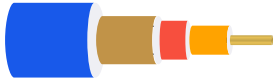

Connectors:  
 Passivated stainless steel (Body & Hex Nut)  
 Gold plated beryllium copper center contacts  
 PTFE Dielectric

### OUTLINE DRAWING

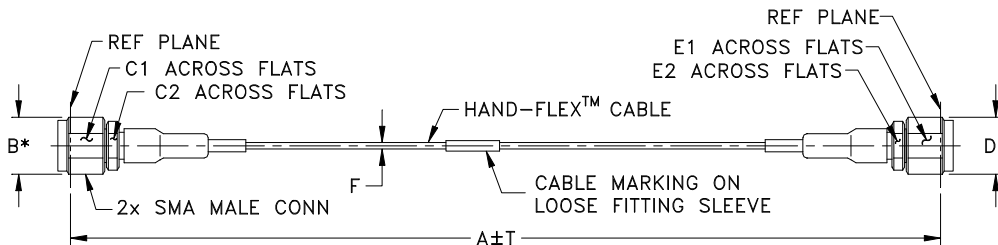

\* OVERALL CONNECTOR DIMENSION  
 [CONNECTOR SHAPE MAY VARY]

### OUTLINE DIMENSIONS (Inch/mm)

A		B	C	D	E1	E2	F	T	wt	
Feet	Meters						Nom	Feet	Meters	grams
6.00	1.83	.36	.313	.250	.313	.250	.062 Nom	0.18	0.05	19.04





# Super-Flexible Test Cable

## SLC-6FT-SMSM+

Mini-Circuits

50Ω 6FT DC to 18 GHz SMA-Male

### TYPICAL PERFORMANCE DATA AND CHARTS

Frequency (MHz)	Insertion Loss (dB)	Return Loss (dB)	
		SMA-Male 1	SMA-Male 2
10	0.22	31.25	30.48
100	0.70	45.00	39.48
200	0.99	37.21	42.33
400	1.41	47.17	45.63
1000	2.24	49.70	53.85
1500	2.75	35.31	34.61
2500	3.57	31.46	31.26
4000	4.53	26.73	26.75
6000	5.59	28.68	26.30
8000	6.50	25.53	23.29
10000	7.31	36.66	24.18
12000	8.06	38.20	24.40
14000	8.81	25.35	23.38
16000	9.52	23.17	22.34
18000	10.12	25.55	29.15

SLC-6FT-SMSM+  
INSERTION LOSS

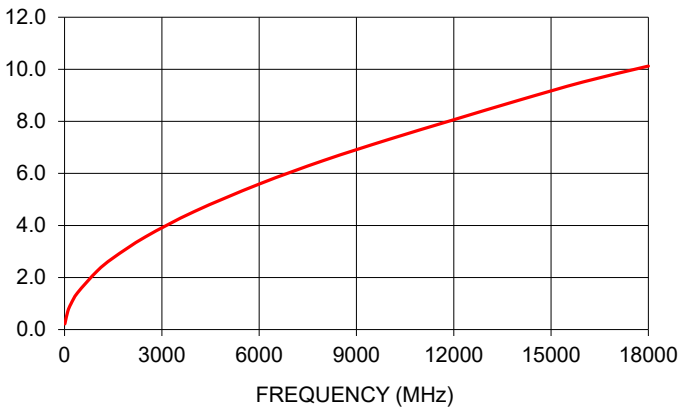

SLC-6FT-SMSM+  
RETURN LOSS

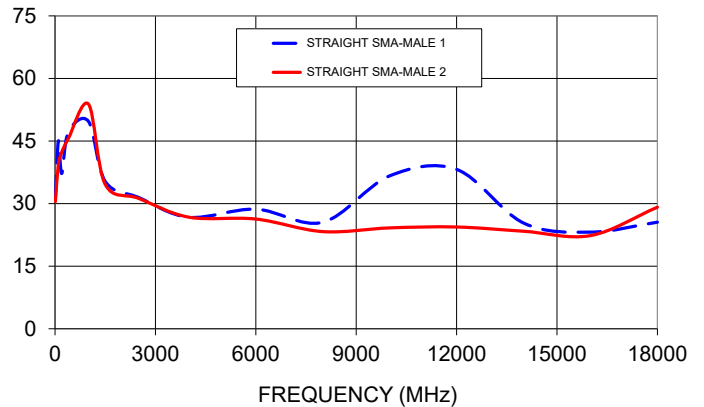

#### NOTES

- A. Performance and quality attributes and conditions not expressly stated in this specification document are intended to be excluded and do not form a part of this specification document.
- B. Electrical specifications and performance data contained in this specification document are based on Mini-Circuit's applicable established test performance criteria and measurement instructions.
- C. The parts covered by this specification document are subject to Mini-Circuits standard limited warranty and terms and conditions (collectively, "Standard Terms"); Purchasers of this part are entitled to the rights and benefits contained therein. For a full statement of the standard terms and the exclusive rights and remedies thereunder, please visit Mini-Circuits' website at [www.minicircuits.com/terms/viewterm.html](http://www.minicircuits.com/terms/viewterm.html)



Typical Performance Data

FREQUENCY (GHz)	INSERTION LOSS (dB)	SMA-MALE 1 RETURN LOSS (dB)	SMA-MALE 2 RETURN LOSS (dB)
0.01	0.22	31.25	30.48
0.1	0.70	45.00	39.48
0.2	0.99	37.21	42.33
0.4	1.41	47.17	45.63
0.6	1.73	42.88	42.72
0.8	2.00	39.78	39.15
1.0	2.24	49.70	53.85
1.5	2.75	35.31	34.61
2.0	3.18	52.52	38.29
2.5	3.57	31.46	31.26
3.0	3.91	32.56	31.91
3.5	4.23	30.13	29.74
4.0	4.53	26.73	26.75
4.5	4.81	30.88	30.16
5.0	5.09	25.13	25.01
5.5	5.35	26.83	25.79
6.0	5.59	28.68	26.30
6.5	5.84	24.26	23.26
7.0	6.06	27.78	25.66
7.5	6.28	27.74	25.51
8.0	6.50	25.53	23.29
8.5	6.70	29.33	25.74
9.0	6.91	31.52	23.64
9.5	7.11	28.64	23.18
10.0	7.31	36.66	24.18
10.5	7.50	38.89	24.68
11.0	7.70	31.15	23.32
11.5	7.89	30.93	23.10
12.0	8.06	38.20	24.40
12.5	8.26	28.30	22.93
13.0	8.45	26.35	23.20
13.5	8.61	29.86	27.38
14.0	8.81	25.35	23.38
14.5	8.99	24.32	22.44
15.0	9.14	28.80	25.10
15.5	9.33	24.46	22.81
16.0	9.52	23.17	22.34
16.5	9.66	25.87	25.86
17.0	9.85	22.69	22.14
17.5	10.00	22.16	24.67
18.0	10.12	25.55	29.15



Typical Performance Curves

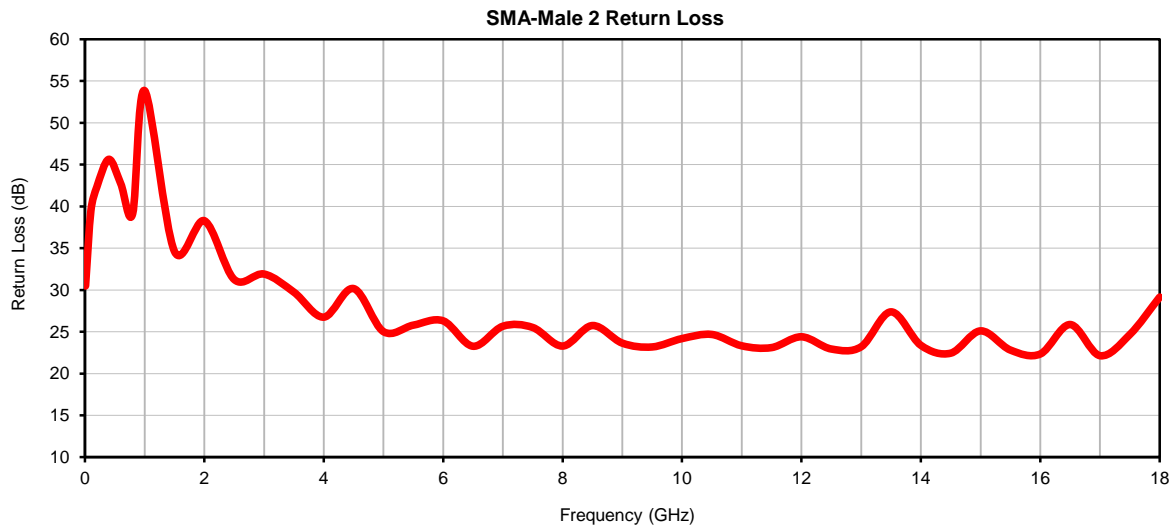
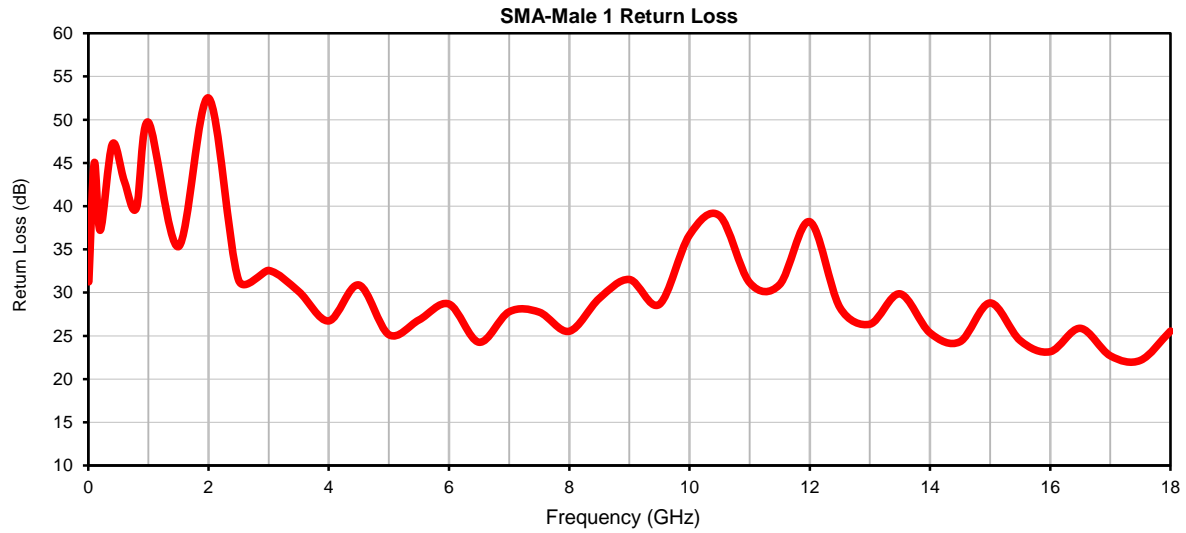

### Outline Dimensions

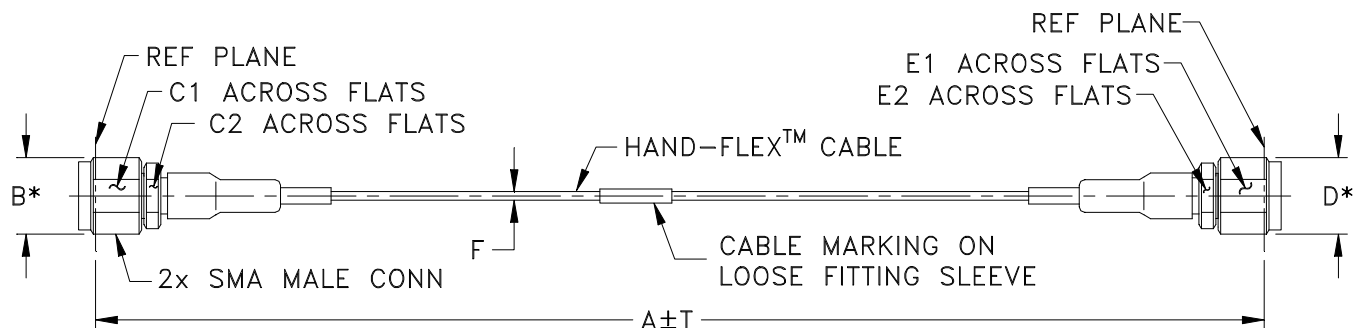

\* OVERALL CONNECTOR DIMENSION  
[CONNECTOR SHAPE MAY VARY]

PH2043 SERIES  
SMA MALE (CONN-1)  
SMA MALE (CONN-2)

CASE STYLE #	A		B	C1	C2	D	E1	E2	F		T		WEIGHT GRAMS
	FEET	METER							SLC(U)-AFT-SMSM+	SLC-AFT-SMSM+	FEET	MM	
PH2043-2	2.00	0.61	.36 (9.14)	.313 (7.95)	.250 (6.35)	.36 (9.14)	.313 (7.95)	.250 (6.35)	.047±.002 (1.19±.05)	.062 NOM (1.57 NOM)	.06	0.02	10.88
PH2043-3	3.00	0.91									.09	0.03	12.92
PH2043-3.28	3.28	1.00									.10	0.03	13.49
PH2043-4	4.00	1.22									.12	0.04	14.96
PH2043-6	6.00	1.83									.18	0.05	19.04
PH2043-20	20.00	6.10									.60	0.18	47.60

Unless otherwise specified dimensions are in inches (mm).

Tolerances: 2Pl. ± .03; 3Pl. ± .015

Note:

1. Super flexible Coaxial Cable.
2. "A" Represents Length of Cable.



All Mini-Circuits products are manufactured under exacting quality assurance and control standards, and are capable of meeting published specifications after being subjected to any or all of the following physical and environmental test.

Specification	Test/Inspection Condition	Reference/Spec
Operating Temperature	-55° to 125° C Ambient Environment	Individual Model Data Sheet
Storage Temperature	-55° to 125° C Ambient Environment	Individual Model Data Sheet
Thermal Shock	-55° to 100° C, 100 cycles	MIL-STD-202, Method 107, Condition A-3
Mechanical Flexing	100,000 cycles During each cycle, cable flexed from 90° through 0° to -90° and back with a Radii of 3 inches	---