

# Surface Mount Power Splitter/Combiner

## SCPQ-60+

2 Way-90° 50Ω 30 to 60 MHz

### Maximum Ratings

Operating Temperature	-40°C to 85°C
Storage Temperature	-55°C to 100°C
Power Input (as a splitter)	1W max.
Permanent damage may occur if any of these limits are exceeded.	

### Pin Connections

SUM PORT	1
PORT 1 (+90°)	2
PORT 2 (0°)	5
GROUND	3,4,7,8
50 OHM TERM EXTERNAL	6

### Outline Drawing

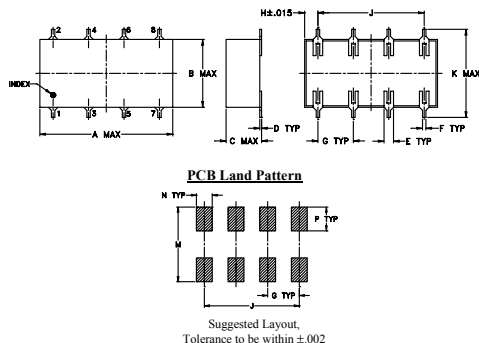

### Outline Dimensions (inch/mm)

A	B	C	D	E	F	G
.75	.38	.20	.010	.050	.020	.200
19.05	9.65	5.08	0.25	1.27	0.51	5.08
H	J	K	M	N	P	wt
.075	.600	.450	.470	.100	.150	grams
1.91	15.24	11.43	11.94	2.54	3.81	1.6

### Demo Board MCL P/N: TB-51 Suggested PCB Layout (PL-062)

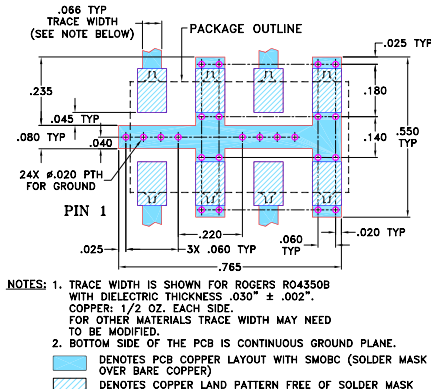

#### Notes

- Performance and quality attributes and conditions not expressly stated in this specification document are intended to be excluded and do not form a part of this specification document.
- Electrical specifications and performance data contained in this specification document are based on Mini-Circuit's applicable established test performance criteria and measurement instructions.
- The parts covered by this specification document are subject to Mini-Circuit's standard limited warranty and terms and conditions (collectively, "Standard Terms"); Purchasers of this part are entitled to the rights and benefits contained therein. For a full statement of the Standard Terms and the exclusive rights and remedies thereunder, please visit Mini-Circuit's website at [www.minicircuits.com/MCLStore/terms.jsp](http://www.minicircuits.com/MCLStore/terms.jsp)

### Features

- low insertion loss, 0.15 dB typ.
- high isolation, 30 dB typ.
- excellent phase unbalance 1 deg. typ.
- excellent VSWR 1.10:1 typ.

### Applications

- VHF
- signal processing
- image reject mixers

### Electrical Specifications

FREQ. RANGE (MHz)	ISOLATION (dB)	INSERTION LOSS (dB) Avg. of Coupled Outputs ABOVE 3 dB	PHASE UNBALANCE (Degrees)	AMPLITUDE UNBALANCE (dB)
$f_L$ - $f_U$	Typ. Min.	Typ. Max.	Max.	Max.
30-60	30 20	0.15 0.7	3	1.5

### Typical Performance Data

Frequency (MHz)	Total Loss <sup>1</sup> (dB)		Amplitude Unbalance (dB)	Isolation (dB)	Phase Unbalance (deg.)	VSWR S	VSWR 1	VSWR 2
	S-1	S-2						
30.00	3.65	2.62	1.03	30.67	89.75	1.04	1.04	1.03
31.00	3.56	2.72	0.84	30.59	89.78	1.04	1.04	1.03
32.00	3.46	2.80	0.66	30.53	89.79	1.04	1.04	1.03
33.50	3.33	2.92	0.42	30.43	89.80	1.04	1.04	1.03
35.00	3.22	3.02	0.20	30.31	89.81	1.03	1.04	1.03
36.50	3.13	3.12	0.01	30.20	89.84	1.03	1.04	1.03
38.00	3.05	3.21	0.16	30.09	89.86	1.03	1.04	1.04
39.50	2.99	3.29	0.30	29.95	89.89	1.03	1.04	1.04
42.00	2.91	3.39	0.48	29.69	89.91	1.03	1.04	1.04
45.00	2.86	3.46	0.60	29.26	89.96	1.02	1.04	1.05
48.00	2.86	3.49	0.63	28.74	90.05	1.02	1.04	1.07
52.00	2.96	3.44	0.48	27.85	90.19	1.02	1.05	1.09
56.00	3.16	3.29	0.13	26.65	90.41	1.03	1.06	1.11
58.00	3.32	3.18	0.14	25.93	90.61	1.04	1.07	1.13
60.00	3.52	3.04	0.48	25.14	90.81	1.05	1.08	1.14

1. Total Loss = Insertion Loss + 3dB splitter loss.

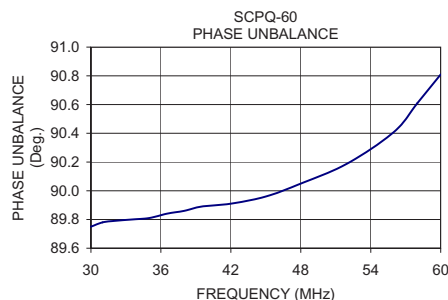
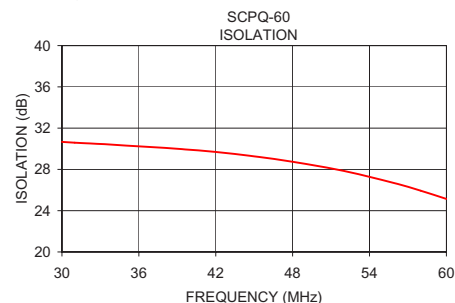
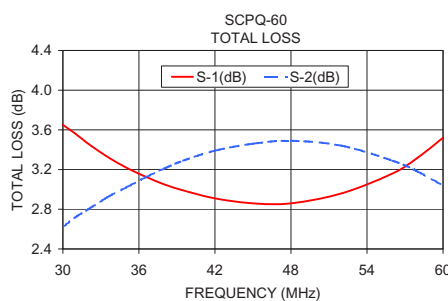

### electrical schematic

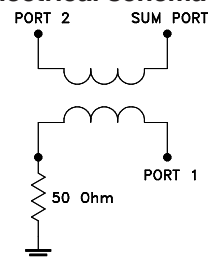

**Mini-Circuits**

[www.minicircuits.com](http://www.minicircuits.com) P.O. Box 350166, Brooklyn, NY 11235-0003 (718) 934-4500 sales@minicircuits.com

REV. C  
M160892  
SCPQ-60+  
HY/TD/CP/AM  
200818



Generic photo used for illustration purposes only

CASE STYLE: YY101

### +RoHS Compliant

The +Suffix identifies RoHS Compliance. See our web site for RoHS Compliance methodologies and qualifications

# 2 Way-90° Power Splitter/Combiner

# SCPQ-60+

## Typical Performance Data

TEST CONDITIONS: INPUT POWER = 0dBm @Temperature = +25°C

FREQ. (MHz)	TOTAL LOSS <sup>1</sup> (dB)		AMP. UNBAL. (dB)	PHASE UNBAL. From 90° (deg.)	ISOLATION (dB) 1-2	VSWR (:1)		
	S-1	S-2				S	1	2
15	6.82	1.09	5.73	0.43	39.45	1.00	1.01	1.01
17	6.06	1.32	4.74	0.47	38.88	1.01	1.01	1.01
19	5.44	1.56	3.88	0.52	38.42	1.01	1.01	1.01
21	4.93	1.79	3.14	0.53	38.09	1.01	1.01	1.01
23	4.50	2.02	2.48	0.55	37.80	1.01	1.01	1.01
25	4.15	2.24	1.91	0.59	37.63	1.01	1.01	1.01
26	4.00	2.35	1.65	0.63	37.55	1.01	1.01	1.01
27	3.85	2.44	1.41	0.62	37.49	1.01	1.01	1.01
28	3.73	2.55	1.18	0.63	37.41	1.01	1.01	1.01
29	3.61	2.64	0.97	0.66	37.42	1.01	1.01	1.01
30	3.51	2.73	0.78	0.68	37.35	1.02	1.01	1.01
31	3.41	2.81	0.59	0.69	37.29	1.02	1.02	1.02
32	3.32	2.90	0.43	0.69	37.24	1.02	1.02	1.02
33	3.25	2.98	0.27	0.73	37.24	1.02	1.02	1.02
34	3.18	3.05	0.13	0.76	37.21	1.02	1.02	1.02
35	3.12	3.12	0.00	0.74	37.18	1.02	1.02	1.02
36	3.06	3.18	0.12	0.77	37.16	1.02	1.02	1.02
37	3.01	3.24	0.23	0.79	37.07	1.02	1.02	1.02
38	2.97	3.29	0.33	0.81	37.05	1.02	1.02	1.02
39	2.93	3.34	0.41	0.80	37.03	1.02	1.02	1.03
40	2.90	3.38	0.48	0.81	36.98	1.02	1.02	1.03
41	2.88	3.41	0.53	0.83	36.91	1.02	1.02	1.03
42	2.86	3.44	0.58	0.83	36.82	1.02	1.02	1.03
43	2.85	3.47	0.62	0.86	36.77	1.02	1.02	1.03
44	2.84	3.48	0.64	0.89	36.66	1.02	1.03	1.04
45	2.85	3.50	0.65	0.89	36.54	1.02	1.03	1.04
46	2.85	3.50	0.65	0.90	36.41	1.02	1.03	1.04
47	2.86	3.50	0.64	0.91	36.27	1.02	1.03	1.04
48	2.88	3.49	0.61	0.90	36.04	1.02	1.03	1.05
49	2.90	3.47	0.57	0.93	35.86	1.02	1.03	1.05
50	2.94	3.45	0.51	0.92	35.65	1.02	1.03	1.05
51	2.98	3.42	0.44	0.95	35.38	1.02	1.03	1.06
52	3.03	3.39	0.36	0.95	35.07	1.02	1.03	1.06
53	3.08	3.34	0.26	0.95	34.73	1.02	1.03	1.07
54	3.16	3.29	0.13	0.92	34.35	1.02	1.03	1.07
55	3.23	3.23	0.00	0.94	33.95	1.01	1.03	1.08
56	3.32	3.17	0.15	0.95	33.45	1.01	1.03	1.08
57	3.42	3.10	0.32	0.93	32.93	1.01	1.03	1.09
58	3.54	3.02	0.51	0.92	32.37	1.01	1.03	1.09
59	3.67	2.93	0.74	0.90	31.76	1.01	1.03	1.10
60	3.82	2.84	0.98	0.88	31.12	1.01	1.04	1.11
62	4.18	2.63	1.55	0.80	29.73	1.02	1.05	1.12
64	4.66	2.40	2.26	0.67	28.18	1.04	1.06	1.14
66	5.29	2.15	3.13	0.45	26.56	1.06	1.08	1.17
68	6.13	1.90	4.24	0.11	24.86	1.08	1.10	1.19
70	7.29	1.64	5.65	0.51	23.15	1.12	1.14	1.23

<sup>1</sup>Total Loss = Insertion Loss+ 3dB Splitter Loss



# 2 Way-90° Power Splitter/Combiner

# SCPQ-60+

## Typical Performance Data

TEST CONDITIONS: INPUT POWER = 0dBm @Temperature = -40°C

FREQ. (MHz)	TOTAL LOSS <sup>1</sup> (dB)		AMP. UNBAL. (dB)	PHASE UNBAL. From 90° (deg.)	ISOLATION (dB) 1-2	VSWR (:1)		
	S-1	S-2				S	1	2
15	6.83	1.08	5.75	0.51	39.12	1.01	1.02	1.01
17	6.07	1.32	4.75	0.56	38.62	1.01	1.02	1.01
19	5.45	1.55	3.89	0.60	38.20	1.01	1.02	1.01
21	4.93	1.78	3.15	0.63	37.92	1.01	1.02	1.01
23	4.51	2.00	2.50	0.67	37.67	1.01	1.01	1.01
25	4.15	2.22	1.92	0.71	37.52	1.01	1.01	1.01
26	3.99	2.33	1.66	0.76	37.49	1.01	1.01	1.01
27	3.85	2.43	1.42	0.77	37.47	1.01	1.01	1.01
28	3.72	2.53	1.19	0.79	37.41	1.01	1.01	1.01
29	3.60	2.63	0.98	0.82	37.42	1.01	1.01	1.01
30	3.50	2.72	0.78	0.86	37.40	1.01	1.00	1.01
31	3.41	2.80	0.60	0.87	37.35	1.01	1.00	1.02
32	3.31	2.89	0.43	0.88	37.34	1.01	1.00	1.02
33	3.23	2.97	0.26	0.92	37.37	1.01	1.00	1.02
34	3.17	3.04	0.13	0.94	37.36	1.01	1.00	1.02
35	3.10	3.11	0.01	0.96	37.35	1.01	1.00	1.02
36	3.04	3.17	0.12	0.98	37.35	1.01	1.00	1.02
37	3.00	3.23	0.23	1.00	37.28	1.01	1.01	1.02
38	2.96	3.28	0.33	1.01	37.28	1.01	1.01	1.03
39	2.92	3.33	0.41	1.02	37.28	1.02	1.01	1.03
40	2.89	3.37	0.48	1.04	37.23	1.02	1.01	1.03
41	2.86	3.41	0.55	1.08	37.16	1.02	1.01	1.03
42	2.84	3.44	0.60	1.09	37.12	1.02	1.01	1.03
43	2.83	3.46	0.63	1.13	37.07	1.02	1.01	1.04
44	2.82	3.48	0.66	1.17	36.93	1.02	1.02	1.04
45	2.82	3.49	0.67	1.17	36.81	1.02	1.02	1.04
46	2.83	3.49	0.66	1.18	36.70	1.02	1.02	1.04
47	2.84	3.49	0.65	1.20	36.52	1.02	1.02	1.05
48	2.86	3.48	0.62	1.22	36.29	1.02	1.02	1.05
49	2.88	3.47	0.59	1.25	36.07	1.02	1.02	1.05
50	2.91	3.44	0.53	1.26	35.85	1.02	1.02	1.06
51	2.95	3.42	0.47	1.30	35.56	1.02	1.02	1.06
52	3.00	3.38	0.38	1.33	35.21	1.02	1.02	1.06
53	3.05	3.34	0.29	1.33	34.83	1.02	1.02	1.07
54	3.12	3.29	0.18	1.33	34.42	1.02	1.02	1.07
55	3.19	3.23	0.04	1.34	33.97	1.02	1.03	1.08
56	3.27	3.17	0.10	1.38	33.45	1.01	1.03	1.08
57	3.37	3.10	0.27	1.38	32.90	1.01	1.03	1.09
58	3.49	3.02	0.46	1.40	32.31	1.01	1.03	1.09
59	3.61	2.93	0.68	1.42	31.68	1.01	1.03	1.10
60	3.76	2.84	0.92	1.39	31.01	1.02	1.04	1.11
62	4.10	2.63	1.47	1.39	29.59	1.02	1.04	1.12
64	4.56	2.40	2.17	1.31	28.04	1.03	1.06	1.14
66	5.17	2.15	3.02	1.19	26.41	1.05	1.08	1.16
68	5.98	1.89	4.09	0.94	24.72	1.08	1.11	1.19
70	7.08	1.63	5.45	0.48	23.01	1.11	1.14	1.22

<sup>1</sup> Total Loss = Insertion Loss+ 3dB Splitter Loss



# 2 Way-90° Power Splitter/Combiner

# SCPQ-60+

## Typical Performance Data

TEST CONDITIONS: INPUT POWER = 0dBm @Temperature = +85°C

FREQ. (MHz)	TOTAL LOSS <sup>1</sup> (dB)		AMP. UNBAL. (dB)	PHASE UNBAL. From 90° (deg.)	ISOLATION (dB) 1-2	VSWR (:1)		
	S-1	S-2				S	1	2
15	6.81	1.10	5.71	0.39	40.14	1.00	1.00	1.01
17	6.06	1.33	4.73	0.40	39.53	1.00	1.01	1.01
19	5.44	1.57	3.86	0.43	39.01	1.01	1.01	1.01
21	4.92	1.80	3.12	0.43	38.61	1.01	1.01	1.01
23	4.50	2.03	2.46	0.43	38.26	1.01	1.02	1.01
25	4.15	2.25	1.89	0.47	38.02	1.02	1.02	1.01
26	4.00	2.36	1.64	0.50	37.92	1.02	1.02	1.01
27	3.85	2.46	1.40	0.49	37.82	1.02	1.03	1.01
28	3.73	2.56	1.17	0.50	37.71	1.02	1.03	1.01
29	3.61	2.65	0.97	0.52	37.67	1.02	1.03	1.01
30	3.51	2.74	0.77	0.53	37.59	1.02	1.03	1.02
31	3.42	2.83	0.58	0.53	37.49	1.02	1.03	1.02
32	3.32	2.92	0.41	0.54	37.39	1.03	1.03	1.02
33	3.25	2.99	0.26	0.55	37.35	1.03	1.03	1.02
34	3.18	3.06	0.12	0.56	37.31	1.03	1.04	1.02
35	3.12	3.13	0.02	0.55	37.23	1.03	1.04	1.02
36	3.06	3.20	0.13	0.57	37.19	1.03	1.04	1.02
37	3.02	3.25	0.23	0.59	37.06	1.03	1.04	1.02
38	2.98	3.30	0.33	0.58	37.04	1.03	1.04	1.02
39	2.94	3.35	0.41	0.58	36.96	1.03	1.04	1.03
40	2.92	3.40	0.48	0.58	36.89	1.03	1.04	1.03
41	2.89	3.43	0.54	0.61	36.80	1.03	1.04	1.03
42	2.87	3.46	0.59	0.59	36.72	1.03	1.04	1.03
43	2.87	3.48	0.61	0.60	36.63	1.03	1.04	1.03
44	2.86	3.49	0.63	0.61	36.52	1.03	1.04	1.03
45	2.86	3.50	0.64	0.61	36.39	1.03	1.04	1.04
46	2.87	3.51	0.64	0.60	36.26	1.03	1.04	1.04
47	2.88	3.51	0.63	0.60	36.11	1.03	1.04	1.04
48	2.91	3.50	0.59	0.58	35.88	1.03	1.04	1.05
49	2.93	3.48	0.55	0.58	35.70	1.03	1.04	1.05
50	2.97	3.45	0.49	0.57	35.51	1.03	1.04	1.05
51	3.01	3.42	0.41	0.59	35.25	1.03	1.04	1.06
52	3.06	3.39	0.33	0.58	34.97	1.02	1.04	1.06
53	3.11	3.34	0.23	0.55	34.63	1.02	1.04	1.06
54	3.19	3.29	0.11	0.52	34.27	1.02	1.04	1.07
55	3.27	3.24	0.03	0.51	33.88	1.02	1.04	1.07
56	3.36	3.17	0.19	0.51	33.41	1.01	1.04	1.08
57	3.47	3.10	0.37	0.47	32.91	1.01	1.04	1.09
58	3.59	3.02	0.56	0.44	32.36	1.01	1.04	1.09
59	3.73	2.94	0.79	0.39	31.77	1.00	1.04	1.10
60	3.88	2.84	1.04	0.34	31.13	1.01	1.05	1.11
62	4.25	2.63	1.62	0.20	29.76	1.02	1.06	1.12
64	4.74	2.40	2.34	0.02	28.23	1.04	1.07	1.15
66	5.40	2.16	3.23	0.32	26.60	1.06	1.09	1.17
68	6.27	1.91	4.37	0.81	24.90	1.09	1.11	1.20
70	7.47	1.66	5.81	1.62	23.19	1.13	1.14	1.23

<sup>1</sup> Total Loss = Insertion Loss+ 3dB Splitter Loss



# 2 Way-90° Power Splitter/Combiner

# SCPQ-60+

## Typical Performance Curves

### Total Loss

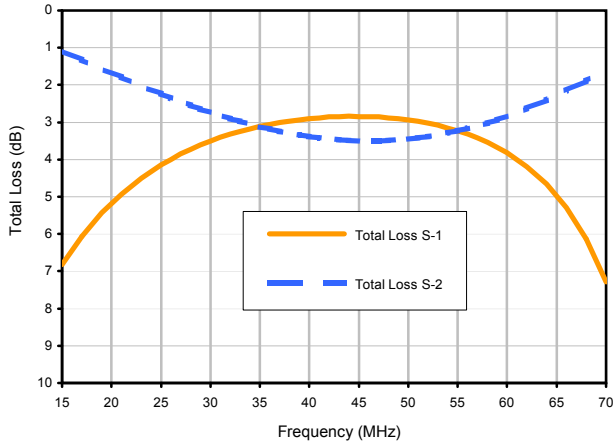

### Total Loss S-1 vs. TEMPERATURE

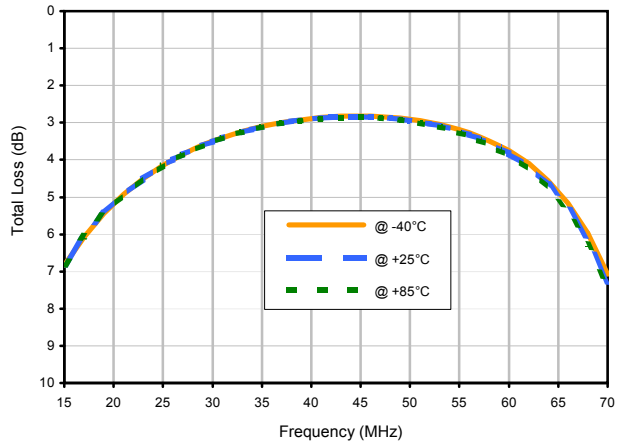

### Amplitude Unbalance vs. TEMPERATURE

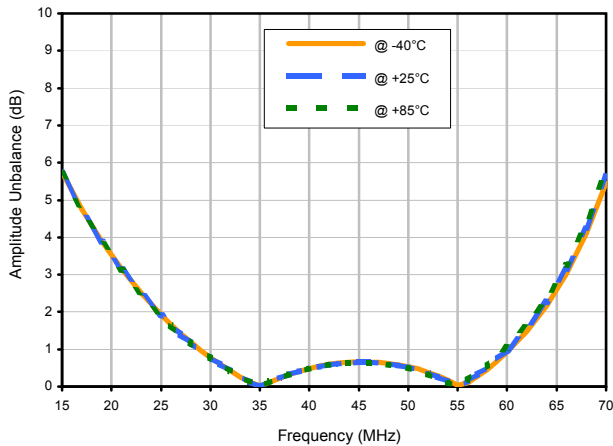

### Phase Unbalance vs. TEMPERATURE

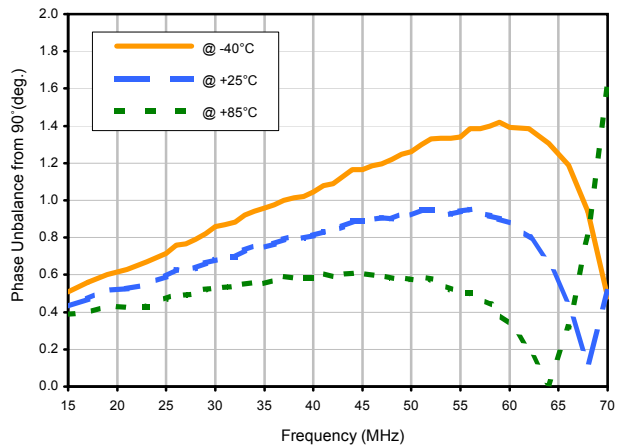

### Isolation 1-2 vs. TEMPERATURE

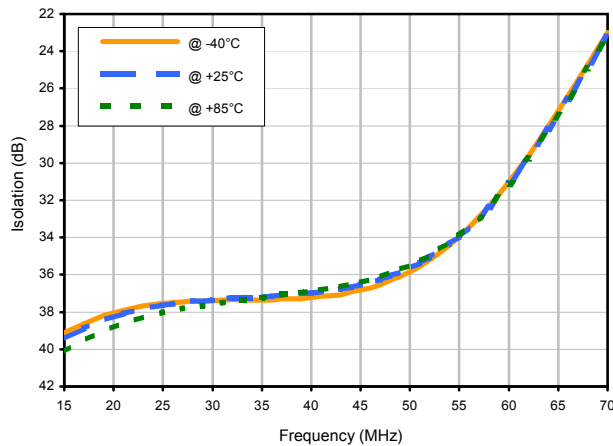

REV. X2  
SCPQ-60+  
100627  
Page 1 of 2



IF/RF MICROWAVE COMPONENTS • ISO 9001 ISO 14001 AS 9100 CERTIFIED • RoHS compliant  
P.O. Box 350166, Brooklyn, New York 11235-0006 (718) 934-4500 Fax (718) 332-4661



The Design Engineers Search Engine finds the model you need, Instantly • For detailed performance specs & shopping online see



## Typical Performance Curves

### VSWR

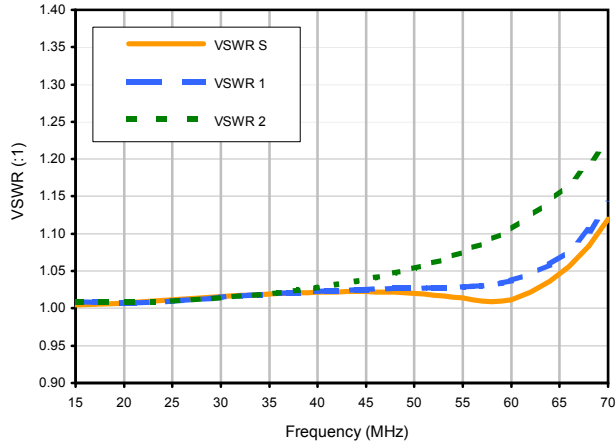

### VSWR SUM vs. TEMPERATURE

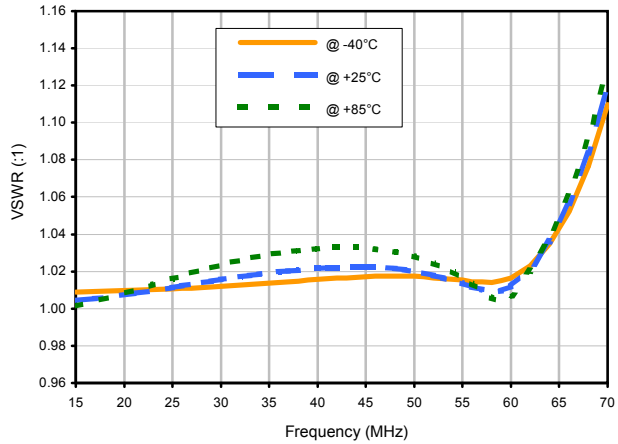

### VSWR OUT1 vs. TEMPERATURE

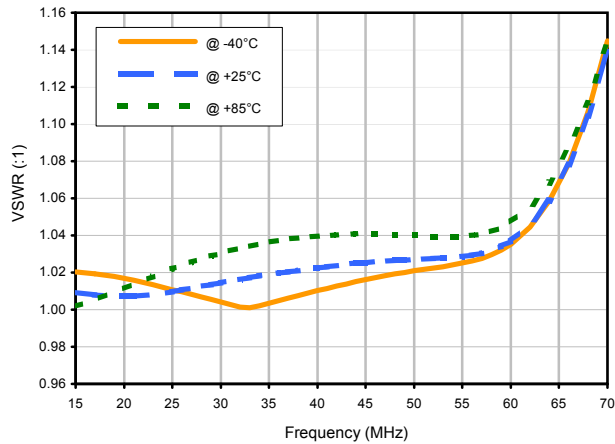

## Outline Dimensions

YY101  
YY109  
YY161

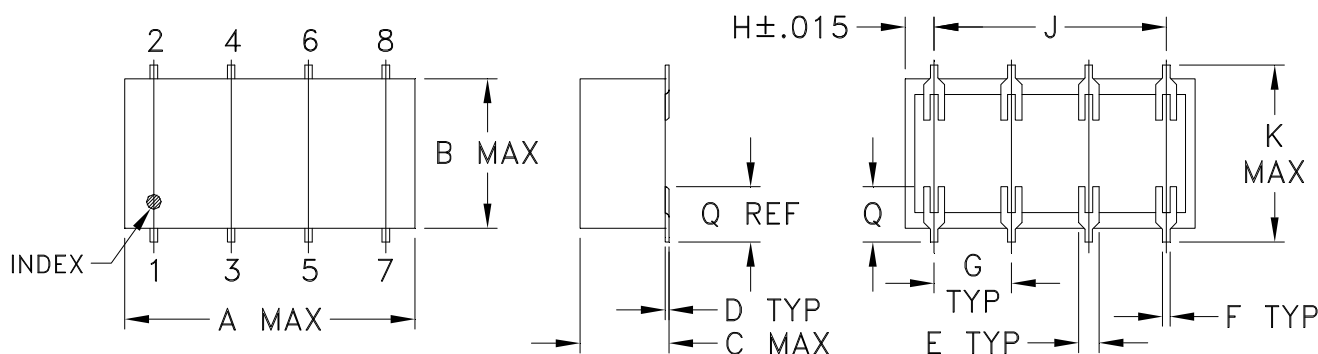

## PCB Land Pattern

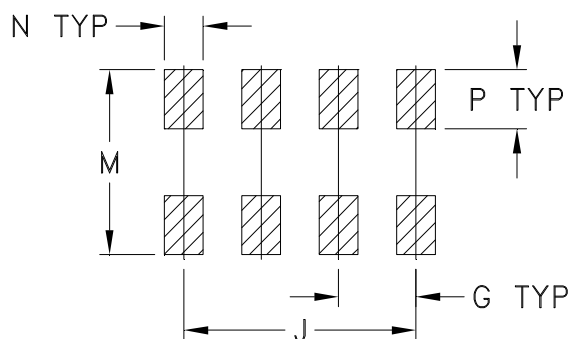

Suggested Layout  
Tolerance to be within  $\pm .002$

CASE#	A	B	C	D	E	F	G	H	J	K	L	M	N	P	Q	WT. GRAMS
YY101*			.20 (5.08)							.450 (11.43)	-- (11.94)	.470 (11.94)				1.6
YY109*	.75 (19.05)	.38 (9.65)	.20 (5.08)	.010 (0.25)	.050 (1.27)	.020 (0.51)	.200 (5.08)	.075 (1.91)	.600 (15.24)	.720 (18.29)	-- (18.80)	.740 (18.80)	.100 (2.54)	.150 (3.81)	.148 (3.76)	1.6
YY161			.28 (7.11)							.450 (11.43)	-- (11.94)	.470 (11.94)				1.6

Dimensions are in inches (mm). Tolerances: 2 Pl.  $\pm .01$ ; 3 Pl.  $\pm .005$

### Notes:

- Case material: Plastic.
- Termination finish:  
For RoHS Case Styles: Tin plate over Nickel plate.  
For RoHS-5 Case Styles: Tin-Lead plate.
- Special Tolerances: Termination thickness  $\pm .003$  inch.
- \* Denotes: For SCM mixers, long termination version (case YY109) is available upon request, consult factory. To order short termination version (case YY101) add -NL suffix.

# Tape & Reel Packaging TR-F5

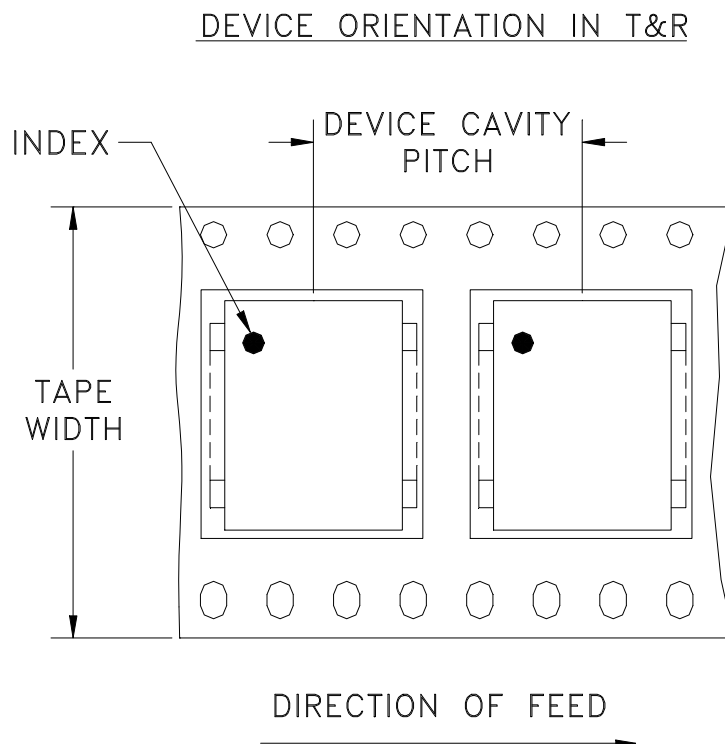

Tape Width, mm	Device Cavity Pitch, mm	Reel Size, inches	Devices per Reel
32	16	13	500

Mini-Circuits carrier tape materials provide protection from ESD (Electro-Static Discharge) during handling and transportation. Tapes are static dissipative and comply with industry standards EIA-481/EIA-541.

Go to: [www.minicircuits.com/pages/pdfs/tape.pdf](http://www.minicircuits.com/pages/pdfs/tape.pdf)



**Distribution Centers** NORTH AMERICA 800-654-7949 • 417-335-5935 • Fax 417-335-5945 • EUROPE 44-1252-832600 • Fax 44-1252-837010

Mini-Circuits ISO 9001 & ISO 14001 Certified

INTERNET <http://www.minicircuits.com>

P.O. Box 350166, Brooklyn, New York 11235-0003 (718) 934-4500 Fax (718) 332-4661



THIRD ANGLE PROJECTION

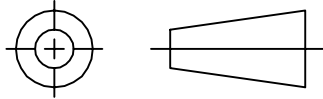

REVISIONS

REV	ECN No.	DESCRIPTION	DATE	DR	AUTH
OR	M82272	NEW RELEASE	08/05/02	MMG	DJ
A	M102713	UPDATED NOTES, ADDED "...WITH SMOBC"	01/16/06	GT	IL

SUGGESTED MOUNTING CONFIGURATION

FOR YY101/YY161 CASE STYLES, "aw/bd/gy" PIN CONNECTIONS

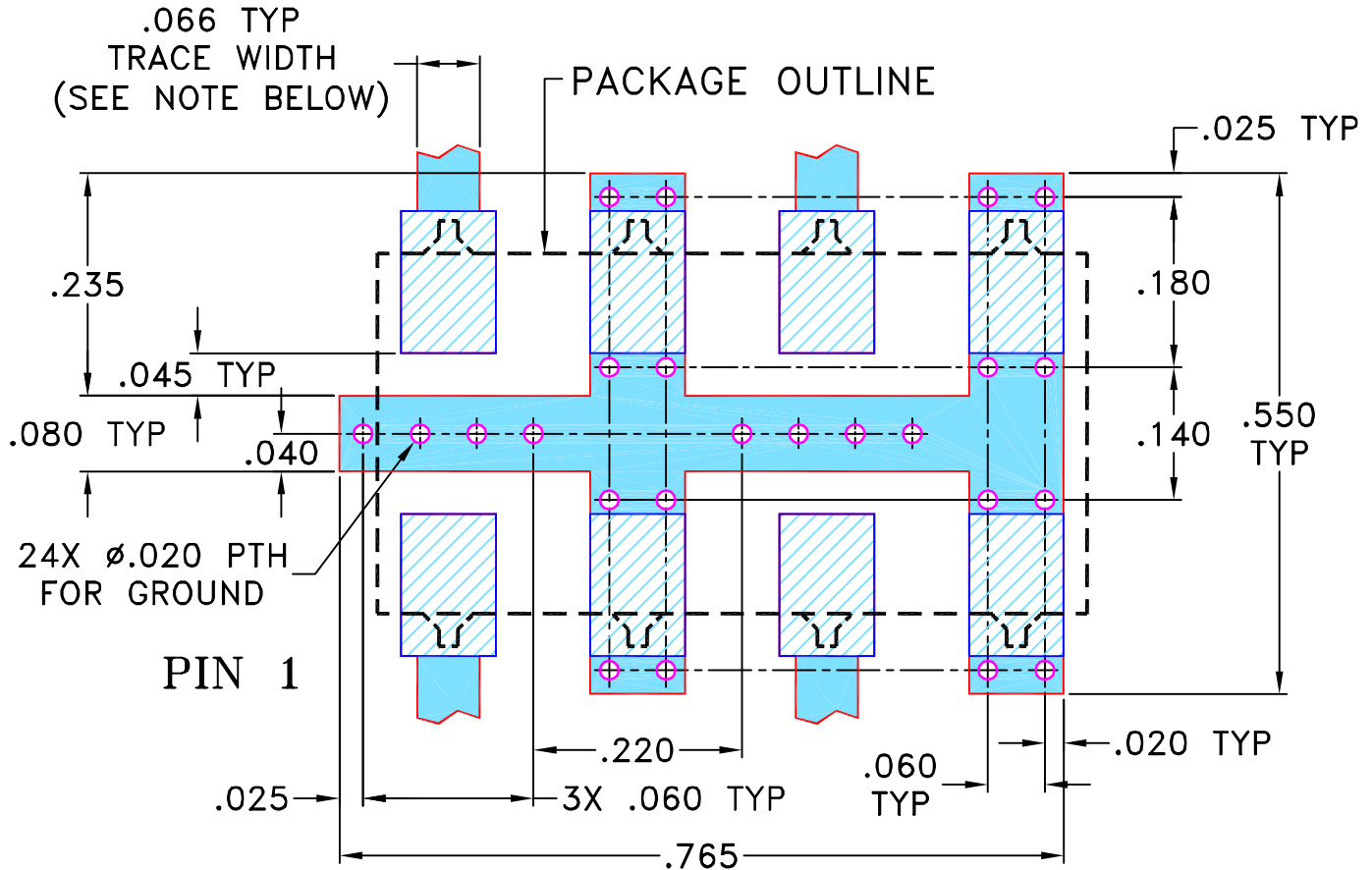

- NOTES:**
1. TRACE WIDTH IS SHOWN FOR ROGERS R04350B WITH DIELECTRIC THICKNESS .030" ± .002".  
COPPER: 1/2 OZ. EACH SIDE.  
FOR OTHER MATERIALS TRACE WIDTH MAY NEED TO BE MODIFIED.
  2. BOTTOM SIDE OF THE PCB IS CONTINUOUS GROUND PLANE.



DENOTES PCB COPPER LAYOUT WITH SMOBC (SOLDER MASK OVER BARE COPPER)

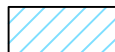

DENOTES COPPER LAND PATTERN FREE OF SOLDER MASK

UNLESS OTHERWISE SPECIFIED	INITIALS	DATE
DIMENSIONS ARE IN INCHES	DRAWN MMG	07/18/02
TOLERANCES ON:	CHECKED HY	08/01/02
2 PL DECIMALS ±	APPROVED DJ	08/05/02
3 PL DECIMALS ± .005		
ANGLES ±		
FRACTIONS ±		



**Mini-Circuits®**

13 Neptune Avenue  
Brooklyn NY 11235

PL, aw/gy/bd, YY101/YY161, SCP(Q), TB-51

THIS DOCUMENT AND ITS CONTENTS ARE THE PROPERTY OF MINI-CIRCUITS. EXCEPT FOR USE EXPRESSLY GRANTED, IN WRITING, TO ITS VENDORS, VENDEE AND THE UNITED STATES GOVERNMENT, MINI-CIRCUITS RESERVES ALL PROPRIETARY DESIGN, USE, MANUFACTURING AND REPRODUCTION RIGHTS THERETO. THESE CONTENTS SHALL NOT BE USED, DUPLICATED OR DISCLOSED TO ANY OUTSIDE PARTY, IN WHOLE OR IN PART, WITHOUT WRITTEN PERMISSION OF MINI-CIRCUITS.

SIZE	CODE IDENT	DRAWING NO:	REV:
A	15542	98-PL-062	A
FILE:	98PL062	SCALE:	5:1
		SHEET:	1 OF 1

ASHEETA1.DWG REV:A DATE:01/12/95

# Evaluation Board and Circuit

For Pins Connections Refer to Data Sheet of the DUT

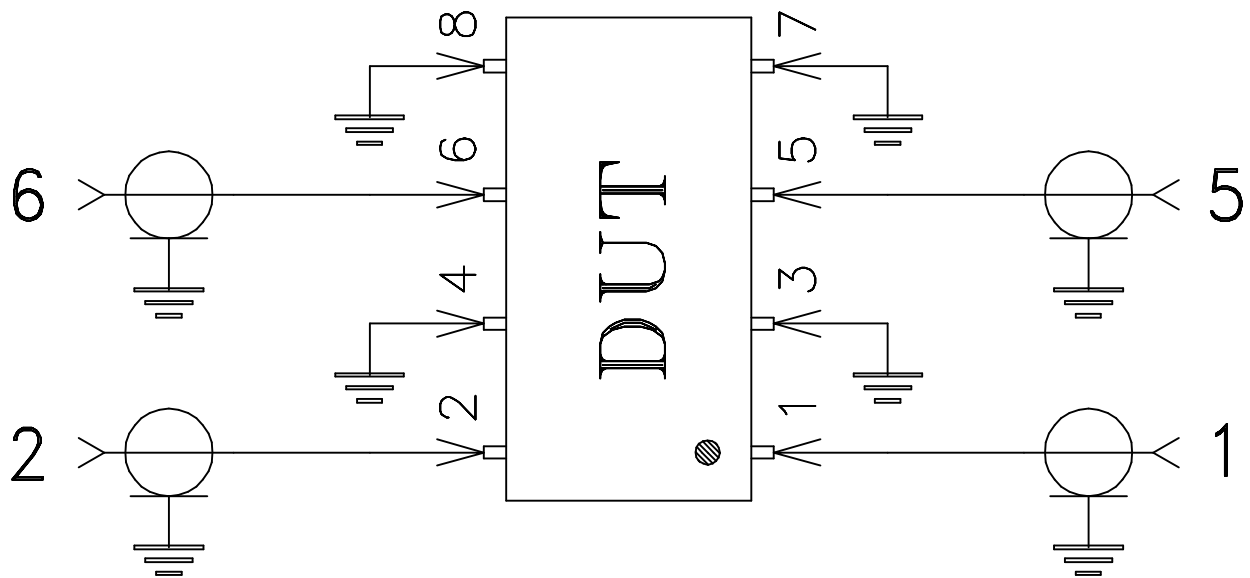
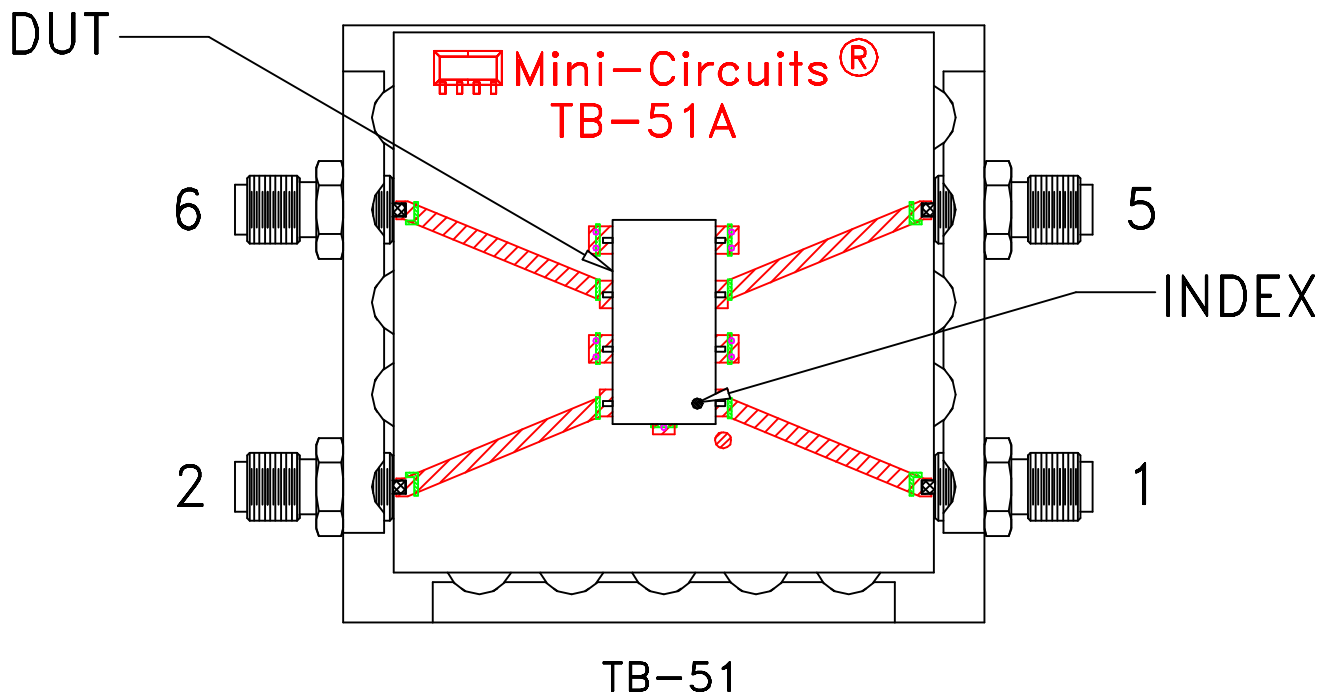

Schematic Diagram

## Notes:

1. SMA Female connectors.
2. PCB Material: Rogers R04350 or equivalent, Dielectric Constant=3.5, Thickness=.030 inch.

 **Mini-Circuits®**

All Mini-Circuits products are manufactured under exacting quality assurance and control standards, and are capable of meeting published specifications after being subjected to any or all of the following physical and environmental test.

Specification	Test/Inspection Condition	Reference/Spec
Operating Temperature	-40° to 85°C Ambient Environment	Individual Model Data Sheet
Storage Temperature	-55° to 100° C Ambient Environment	Individual Model Data Sheet
Humidity	90 to 95% RH, 240 hours, 50°C	MIL-STD-202, Method 103, Condition A, Except 50°C and end-point electrical test done within 12 hours
Thermal Shock	-55° to 100°C, 100 cycles	MIL-STD-202, Method 107, Condition A-3, except +100°C
Solder Reflow Heat	Sn-Pb Eutetic Process: 225°C peak Pb-Free Process 245° - 250°C peak	J-STD-020, Table 4-1, 4-2 and 5-2, Figure 5-1
Solderability	10X Magnification	J-STD-002, 95% Coverage
Vibration (High Frequency)	20g peak, 10-2000 Hz, 12 times in each of three perpendicular directions (total 36)	MIL-STD-202, Method 204, Condition D
Mechanical Shock	50g, 11 ms, 1/2-sine, 18 shocks: 3 each direction, each of 3 axes	MIL-STD-202, Method 213, Condition A
Marking Resistance to Solvents	Isopropyl alcohol + mineral spirits at 25°C; terpene defluxer at 25°C; distilled water + proylene glycol monomethyl ether + monoethanolamine at 63°C to 70°C	MIL-STD-202, Method 215