

Surface Mount

# Power Splitter/Combiner

## SBTC-2-10-75L+

2 Way-0° 75Ω 10 to 1000 MHz

### Features

- low insertion loss, 0.8 dB typ.
- high isolation
- excellent amplitude unbalance, 0.15 dB typ.
- very good phase unbalance, 1.0 deg. typ.
- temperature stable LTCC base
- small size
- low cost
- aqueous washable

### Applications

- UHF/VHF receivers/transmitters
- cellular

For Model  
without Leads see  
SBTC-2-10-75+



Generic photo used for illustration purposes only

CASE STYLE: AT1029

### +RoHS Compliant

The +Suffix identifies RoHS Compliance. See our web site for RoHS Compliance methodologies and qualifications

Available Tape and Reel at no extra cost	
Reel Size	Devices/Reel
7"	20, 50, 100, 200, 500
13"	1000, 2000

### Electrical Specifications

Parameter	Frequency (MHz)	Min.	Typ.	Max.	Unit
Frequency Range		10		1000	MHz
Insertion Loss Above 3.0 dB	10 - 100	—	0.7	1.2	dB
	100 - 500	—	0.6	1.2	
	500 - 1000	—	0.7	1.4	
Isolation	10 - 100	20	35	—	dB
	100 - 500	20	28	—	
	500 - 1000	21	21	—	
Phase Unbalance	10 - 100	—	—	3	Degree
	100 - 500	—	—	3	
	500 - 1000	—	—	5	
Amplitude Unbalance	10 - 100	—	—	0.7	dB
	100 - 500	—	—	0.6	
	500 - 1000	—	—	0.6	

### Maximum Ratings

Parameter	Ratings
Operating Temperature	-40°C to 85°C
Storage Temperature	-55°C to 100°C
Power Input (as a splitter)	0.5W max.
Internal Dissipation	0.125W max

Permanent damage may occur if any of these limits are exceeded.

### Pin Connections

Function	Pin Number
SUM PORT	6
PORT 1	3
PORT 2	4
GROUND	1,2
NOT USED	5

### Electrical Schematic



## Outline Drawing

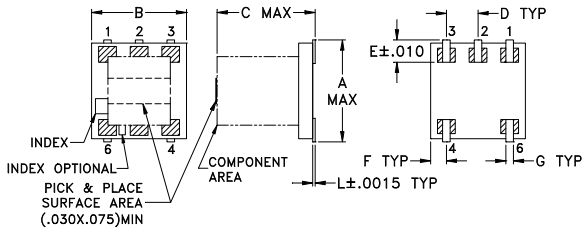

## Outline Dimensions (inch/mm)

A	B	C	D	E	F	G	H	J	K	L	wt
.166	.150	.155	.050	.037	.025	.012	.060	.184	.030	.004	grams
4.22	3.81	3.94	1.27	0.94	0.64	0.30	1.52	4.67	0.76	0.10	0.10

## PCB Land Pattern

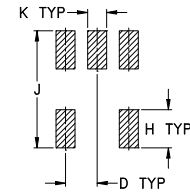

Suggested Layout,  
Tolerance to be within ±.002

## Demo Board MCL P/N: TB-277 Suggested PCB Layout (PL-153)

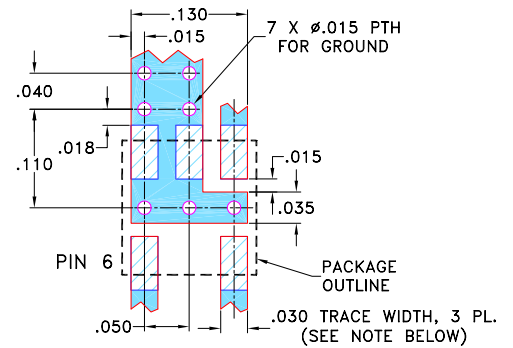

NOTE: 1. TRACE WIDTH IS SHOWN FOR ROGERS RO4350B WITH DIELECTRIC THICKNESS  $0.030 \pm 0.002$ ; COPPER: 1/2 OZ. EACH SIDE. FOR OTHER MATERIALS TRACE WIDTH MAY NEED TO BE MODIFIED.

2. BOTTOM SIDE OF THE PCB IS CONTINUOUS GROUND PLANE.

DENOTES PCB COPPER LAYOUT WITH SMOBC (SOLDER MASK OVER BARE COPPER)

DENOTES COPPER LAND PATTERN FREE OF SOLDER MASK

## Typical Performance Data

Frequency (MHz)	Total Loss <sup>1</sup> (dB)		Amplitude Unbalance (dB)	Isolation (dB)	Phase Unbalance (deg.)	VSWR S	VSWR 1	VSWR 2
	S-1	S-2						
10	3.74	3.42	0.31	37.11	0.66	1.04	1.33	1.23
50	3.73	3.43	0.3	40.95	0.14	1.02	1.29	1.21
70	3.73	3.44	0.29	39.94	0.14	1.03	1.28	1.21
100	3.74	3.46	0.29	38.55	0.13	1.04	1.27	1.2
200	3.77	3.54	0.22	35.75	0.09	1.1	1.26	1.21
300	3.79	3.57	0.22	32.58	0.54	1.13	1.27	1.22
400	3.8	3.6	0.2	30.37	0.6	1.17	1.28	1.26
500	3.85	3.69	0.16	28.37	0.64	1.2	1.24	1.27
600	3.87	3.75	0.12	25.52	0.74	1.18	1.21	1.28
700	3.82	3.75	0.07	24.07	0.75	1.19	1.2	1.3
800	3.83	3.82	0.03	22.85	0.77	1.19	1.26	1.32
850	3.84	3.86	0.03	22.4	0.73	1.18	1.23	1.31
900	3.85	3.9	0.06	22.15	0.69	1.17	1.23	1.32
950	3.86	3.93	0.08	21.95	0.64	1.18	1.25	1.35
1000	3.86	3.98	0.11	21.68	0.58	1.18	1.25	1.35

1. Total Loss = Insertion Loss + 3dB splitter loss.

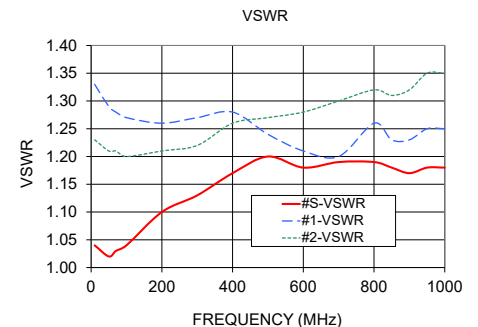
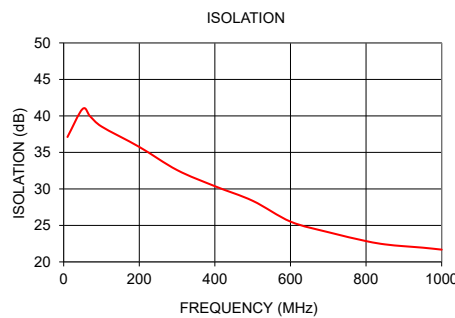
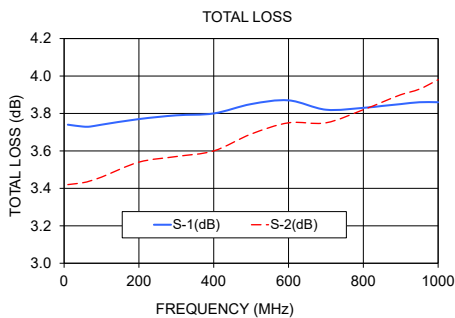

## Additional Notes

- Performance and quality attributes and conditions not expressly stated in this specification document are intended to be excluded and do not form a part of this specification document.
- Electrical specifications and performance data contained in this specification document are based on Mini-Circuits' applicable established test performance criteria and measurement instructions.
- The parts covered by this specification document are subject to Mini-Circuits standard limited warranty and terms and conditions (collectively, "Standard Terms"); Purchasers of this part are entitled to the rights and benefits contained therein. For a full statement of the Standard Terms and the exclusive rights and remedies thereunder, please visit Mini-Circuits' website at [www.minicircuits.com/MCLStore/terms.jsp](http://www.minicircuits.com/MCLStore/terms.jsp)

# 2 Way-0° Power Splitter/Combiner SBTC-2-10-75L+

## Typical Performance Data

TEST CONDITIONS: INPUT POWER = 0dBm @Temperature = +25°C

FREQ. (MHz)	TOTAL LOSS <sup>1</sup> (dB)		AMP. UNBAL. (dB)	PHASE UNBAL. (deg.)	ISOLATION (dB)	VSWR (:1)		
	S-1	S-2				S	1	2
10	3.74	3.43	0.31	0.40	38.17	1.04	1.33	1.25
20	3.74	3.43	0.31	0.14	40.42	1.01	1.32	1.24
30	3.75	3.44	0.31	0.07	40.25	1.01	1.32	1.24
40	3.75	3.44	0.31	0.04	39.82	1.01	1.31	1.24
50	3.76	3.45	0.31	0.01	39.20	1.02	1.31	1.24
60	3.76	3.45	0.31	0.00	38.60	1.02	1.31	1.24
70	3.77	3.46	0.31	0.04	38.09	1.03	1.31	1.24
80	3.77	3.46	0.31	0.10	37.71	1.04	1.31	1.24
90	3.78	3.47	0.31	0.06	37.33	1.05	1.31	1.24
100	3.78	3.47	0.31	0.09	36.86	1.05	1.31	1.24
150	3.80	3.49	0.31	0.16	35.41	1.08	1.30	1.22
200	3.81	3.51	0.30	0.23	34.69	1.11	1.28	1.23
250	3.82	3.52	0.30	0.33	33.78	1.14	1.27	1.25
300	3.83	3.54	0.29	0.42	31.91	1.16	1.26	1.25
350	3.83	3.57	0.26	0.52	30.17	1.18	1.25	1.23
400	3.84	3.59	0.25	0.62	29.14	1.19	1.24	1.24
450	3.86	3.61	0.25	0.69	28.73	1.20	1.23	1.26
475	3.89	3.62	0.27	0.76	28.37	1.20	1.23	1.27
500	3.88	3.64	0.24	0.77	28.42	1.21	1.22	1.27
550	3.90	3.66	0.24	0.84	27.43	1.21	1.22	1.25
600	3.93	3.70	0.23	0.91	26.12	1.22	1.22	1.25
650	3.96	3.73	0.23	1.01	25.28	1.22	1.21	1.26
700	3.99	3.75	0.24	1.12	24.90	1.21	1.22	1.28
750	4.02	3.77	0.25	1.27	24.43	1.20	1.22	1.27
800	4.04	3.81	0.23	1.42	23.64	1.17	1.22	1.25
850	4.05	3.83	0.22	1.50	22.66	1.16	1.23	1.25
900	4.08	3.87	0.21	1.55	21.80	1.14	1.24	1.26
925	4.11	3.88	0.23	1.37	21.56	1.13	1.25	1.26
950	4.11	3.90	0.21	1.53	21.36	1.12	1.26	1.26
975	4.14	3.91	0.23	1.44	21.01	1.10	1.26	1.25
1000	4.14	3.93	0.21	1.51	20.93	1.09	1.27	1.24
1025	4.17	3.94	0.23	1.49	20.67	1.08	1.28	1.24
1050	4.17	3.96	0.21	1.40	20.27	1.07	1.29	1.24
1075	4.19	3.97	0.22	1.42	20.21	1.06	1.30	1.24
1100	4.20	4.00	0.20	1.36	19.64	1.05	1.30	1.24
1200	4.25	4.07	0.18	1.17	19.05	1.00	1.34	1.26
1300	4.31	4.16	0.16	1.02	19.18	1.02	1.38	1.29
1400	4.37	4.23	0.14	1.15	19.44	1.04	1.42	1.32
1500	4.41	4.32	0.08	1.37	20.37	1.04	1.46	1.34
1600	4.49	4.47	0.02	1.65	22.35	1.06	1.50	1.36
1700	4.68	4.68	0.00	1.87	24.09	1.07	1.55	1.39
1800	4.99	4.95	0.04	1.95	23.16	1.09	1.61	1.44
1900	5.27	5.12	0.15	1.44	21.07	1.11	1.68	1.52
2000	5.47	5.13	0.34	1.42	19.25	1.15	1.77	1.63
2100	5.42	5.10	0.33	1.14	18.21	1.19	1.87	1.77
2200	5.32	4.95	0.37	0.90	17.84	1.20	1.95	1.87
2300	5.31	4.90	0.42	1.42	17.92	1.19	2.01	1.94
2400	5.33	5.09	0.25	1.29	17.27	1.16	2.04	1.93
2500	5.72	5.67	0.06	0.76	15.76	1.16	2.07	1.92
2600	6.26	6.20	0.06	0.39	14.03	1.17	2.09	1.84
2700	7.25	6.85	0.40	2.05	12.30	1.19	2.09	1.76
2800	8.14	7.49	0.65	5.41	11.31	1.23	2.08	1.68
2900	8.80	7.68	1.12	5.96	10.84	1.25	2.09	1.65
3000	9.09	7.36	1.73	5.76	10.47	1.28	2.08	1.64

<sup>1</sup>Total Loss = Insertion Loss+ 3dB Splitter Loss

REV. X2

SBTC-2-10-75L+

100627

Page 1 of 3



IF/RF MICROWAVE COMPONENTS • ISO 9001 ISO 14001 AS 9100 CERTIFIED • RoHS compliant

P.O. Box 350166, Brooklyn, New York 11235-0003 (718) 934-4500 Fax (718) 332-4661



The Design Engineers Search Engine finds the model you need, Instantly • For detailed performance specs & shopping online see



# 2 Way-0° Power Splitter/Combiner SBTC-2-10-75L+

## Typical Performance Data

TEST CONDITIONS: INPUT POWER = 0dBm @Temperature = -40°C

FREQ. (MHz)	TOTAL LOSS <sup>1</sup> (dB)		AMP. UNBAL. (dB)	PHASE UNBAL. (deg.)	ISOLATION (dB)	VSWR (:1)		
	S-1	S-2				S	1	2
10	3.59	3.36	0.23	1.51	32.58	1.08	1.33	1.24
20	3.53	3.33	0.20	0.73	39.16	1.05	1.26	1.20
30	3.52	3.32	0.20	0.45	44.50	1.05	1.24	1.18
40	3.52	3.33	0.19	0.33	50.02	1.05	1.23	1.17
50	3.53	3.33	0.20	0.24	54.11	1.06	1.23	1.16
60	3.53	3.33	0.20	0.23	52.55	1.07	1.22	1.16
70	3.53	3.33	0.20	0.19	48.97	1.07	1.22	1.15
80	3.53	3.33	0.20	0.13	46.41	1.07	1.22	1.16
90	3.54	3.34	0.20	0.17	44.29	1.06	1.21	1.16
100	3.54	3.34	0.20	0.12	42.54	1.06	1.21	1.16
150	3.56	3.36	0.20	0.09	38.32	1.08	1.20	1.18
200	3.57	3.36	0.21	0.09	36.49	1.10	1.20	1.17
250	3.58	3.38	0.20	0.07	35.13	1.11	1.21	1.21
300	3.59	3.39	0.20	0.08	33.05	1.14	1.22	1.22
350	3.60	3.41	0.19	0.09	30.81	1.16	1.24	1.21
400	3.61	3.43	0.18	0.11	29.35	1.17	1.25	1.23
450	3.63	3.44	0.19	0.17	28.71	1.20	1.25	1.27
475	3.65	3.45	0.20	0.15	28.30	1.21	1.26	1.28
500	3.64	3.46	0.18	0.22	28.43	1.21	1.26	1.29
550	3.66	3.48	0.18	0.29	27.50	1.24	1.26	1.28
600	3.68	3.50	0.18	0.35	26.04	1.24	1.27	1.27
650	3.70	3.52	0.18	0.38	24.95	1.25	1.27	1.30
700	3.74	3.54	0.20	0.37	24.30	1.25	1.27	1.31
750	3.75	3.55	0.20	0.34	23.71	1.22	1.28	1.30
800	3.76	3.58	0.18	0.30	22.91	1.19	1.28	1.28
850	3.77	3.60	0.17	0.32	21.80	1.15	1.28	1.27
900	3.79	3.63	0.16	0.43	20.82	1.12	1.28	1.27
925	3.82	3.63	0.19	0.68	20.57	1.11	1.28	1.26
950	3.81	3.65	0.16	0.57	20.29	1.09	1.28	1.25
975	3.84	3.65	0.19	0.73	19.91	1.07	1.28	1.24
1000	3.84	3.67	0.17	0.76	19.82	1.05	1.28	1.22
1025	3.87	3.68	0.19	0.81	19.58	1.03	1.28	1.21
1050	3.87	3.69	0.18	0.98	19.21	1.02	1.28	1.20
1075	3.89	3.70	0.19	0.98	19.14	1.02	1.29	1.19
1100	3.90	3.72	0.18	1.13	18.60	1.03	1.29	1.19
1200	3.95	3.79	0.16	1.58	18.04	1.09	1.31	1.18
1300	4.01	3.86	0.15	2.05	18.26	1.10	1.33	1.21
1400	4.05	3.92	0.13	2.31	18.67	1.09	1.38	1.28
1500	4.06	3.99	0.07	2.45	19.81	1.06	1.47	1.39
1600	4.13	4.12	0.01	2.45	22.10	1.02	1.58	1.52
1700	4.31	4.33	0.02	2.42	24.23	1.02	1.69	1.64
1800	4.65	4.66	0.01	2.63	22.90	1.02	1.79	1.71
1900	4.92	4.78	0.14	3.48	20.52	1.04	1.84	1.73
2000	5.09	4.75	0.35	3.63	18.74	1.06	1.87	1.69
2100	5.00	4.65	0.35	4.37	17.87	1.14	1.88	1.64
2200	4.89	4.46	0.43	6.68	17.83	1.24	1.91	1.59
2300	4.89	4.46	0.43	7.81	18.20	1.30	1.94	1.63
2400	4.88	4.61	0.28	8.29	17.35	1.36	1.99	1.75
2500	5.27	5.21	0.06	7.63	15.03	1.37	2.10	1.99
2600	5.87	5.92	0.05	7.90	12.92	1.39	2.25	2.26
2700	6.99	6.66	0.33	5.86	11.17	1.30	2.33	2.48
2800	7.93	7.38	0.55	2.37	10.21	1.17	2.37	2.50
2900	8.43	7.51	0.92	2.21	9.87	1.05	2.34	2.35
3000	8.56	6.98	1.58	2.82	9.60	1.23	2.25	2.16

<sup>1</sup>Total Loss = Insertion Loss+ 3dB Splitter Loss

REV. X2

SBTC-2-10-75L+

100627

Page 2 of 3



IF/RF MICROWAVE COMPONENTS • ISO 9001 ISO 14001 AS 9100 CERTIFIED RoHS compliant

P.O. Box 350166, Brooklyn, New York 11235-0003 (718) 934-4500 Fax (718) 332-4661



The Design Engineers Search Engine finds the model you need, Instantly • For detailed performance specs & shopping online see



# 2 Way-0° Power Splitter/Combiner SBTC-2-10-75L+

## Typical Performance Data

TEST CONDITIONS: INPUT POWER = 0dBm @Temperature = +85°C

FREQ. (MHz)	TOTAL LOSS <sup>1</sup> (dB)		AMP. UNBAL. (dB)	PHASE UNBAL. (deg.)	ISOLATION (dB)	VSWR (:1)		
	S-1	S-2				S	1	2
10	3.86	3.51	0.35	0.40	35.73	1.05	1.38	1.28
20	3.86	3.50	0.36	0.16	36.56	1.04	1.36	1.27
30	3.88	3.52	0.36	0.10	36.31	1.04	1.36	1.28
40	3.88	3.53	0.35	0.07	35.98	1.04	1.36	1.29
50	3.88	3.53	0.35	0.02	35.59	1.05	1.36	1.30
60	3.89	3.54	0.35	0.05	35.31	1.06	1.36	1.30
70	3.89	3.54	0.35	0.01	35.03	1.06	1.36	1.30
80	3.90	3.54	0.36	0.06	34.82	1.07	1.36	1.30
90	3.91	3.55	0.36	0.01	34.71	1.08	1.36	1.30
100	3.91	3.56	0.35	0.06	34.51	1.08	1.35	1.29
150	3.92	3.58	0.34	0.10	33.74	1.09	1.34	1.25
200	3.92	3.59	0.33	0.18	33.30	1.11	1.32	1.26
250	3.93	3.62	0.31	0.29	32.61	1.15	1.30	1.27
300	3.94	3.64	0.30	0.41	30.96	1.17	1.27	1.25
350	3.95	3.66	0.29	0.52	29.46	1.17	1.25	1.24
400	3.96	3.69	0.27	0.64	28.68	1.19	1.24	1.25
450	3.98	3.72	0.26	0.73	28.39	1.19	1.22	1.26
475	4.01	3.72	0.29	0.78	28.05	1.19	1.22	1.26
500	4.01	3.75	0.26	0.81	28.06	1.19	1.21	1.26
550	4.03	3.78	0.25	0.92	27.15	1.20	1.20	1.25
600	4.06	3.82	0.24	0.99	26.03	1.20	1.20	1.24
650	4.08	3.85	0.23	1.11	25.37	1.20	1.20	1.25
700	4.12	3.87	0.24	1.24	25.11	1.20	1.20	1.27
750	4.14	3.90	0.24	1.39	24.72	1.19	1.20	1.25
800	4.17	3.94	0.23	1.59	24.01	1.17	1.21	1.24
850	4.18	3.97	0.21	1.70	23.09	1.17	1.22	1.25
900	4.21	4.01	0.20	1.79	22.26	1.16	1.23	1.27
925	4.24	4.02	0.22	1.61	22.03	1.15	1.24	1.27
950	4.24	4.04	0.20	1.81	21.85	1.14	1.25	1.26
975	4.26	4.05	0.21	1.69	21.48	1.13	1.26	1.25
1000	4.27	4.08	0.19	1.77	21.41	1.12	1.27	1.25
1025	4.30	4.09	0.21	1.77	21.16	1.11	1.28	1.25
1050	4.30	4.11	0.19	1.74	20.73	1.11	1.29	1.25
1075	4.32	4.12	0.20	1.77	20.66	1.10	1.30	1.26
1100	4.32	4.15	0.17	1.75	20.08	1.09	1.31	1.26
1200	4.37	4.23	0.14	1.64	19.47	1.03	1.35	1.28
1300	4.44	4.31	0.13	1.57	19.54	1.02	1.39	1.30
1400	4.50	4.39	0.11	1.82	19.72	1.01	1.42	1.33
1500	4.55	4.49	0.05	2.08	20.60	1.03	1.45	1.32
1600	4.64	4.64	0.00	2.42	22.49	1.06	1.47	1.33
1700	4.83	4.85	0.02	2.70	24.10	1.09	1.50	1.33
1800	5.13	5.11	0.02	2.89	23.29	1.13	1.54	1.38
1900	5.41	5.28	0.13	2.48	21.29	1.17	1.62	1.47
2000	5.61	5.30	0.31	2.45	19.50	1.22	1.72	1.61
2100	5.57	5.27	0.31	2.37	18.44	1.27	1.83	1.80
2200	5.47	5.15	0.32	0.69	18.10	1.27	1.94	1.93
2300	5.48	5.12	0.37	0.12	18.22	1.24	2.01	2.00
2400	5.50	5.32	0.19	0.24	17.65	1.18	2.03	1.96
2500	5.87	5.89	0.01	0.68	16.27	1.15	2.05	1.90
2600	6.39	6.39	0.00	1.30	14.59	1.17	2.05	1.75
2700	7.33	7.01	0.32	3.88	12.82	1.24	2.03	1.64
2800	8.19	7.60	0.59	7.32	11.80	1.30	2.02	1.57
2900	8.83	7.75	1.08	8.20	11.30	1.34	2.04	1.58
3000	9.13	7.44	1.69	8.11	10.89	1.35	2.06	1.63

<sup>1</sup>Total Loss = Insertion Loss+ 3dB Splitter Loss

REV. X2

SBTC-2-10-75L+

100627

Page 3 of 3



IF/RF MICROWAVE COMPONENTS • ISO 9001 ISO 14001 AS 9100 CERTIFIED RoHS compliant

P.O. Box 350166, Brooklyn, New York 11235-0003 (718) 934-4500 Fax (718) 332-4661



The Design Engineers Search Engine finds the model you need, Instantly • For detailed performance specs & shopping online see



# 2 Way-0° Power Splitter/Combiner

# SBTC-2-10-75L+

## Typical Performance Curves

### Total Loss

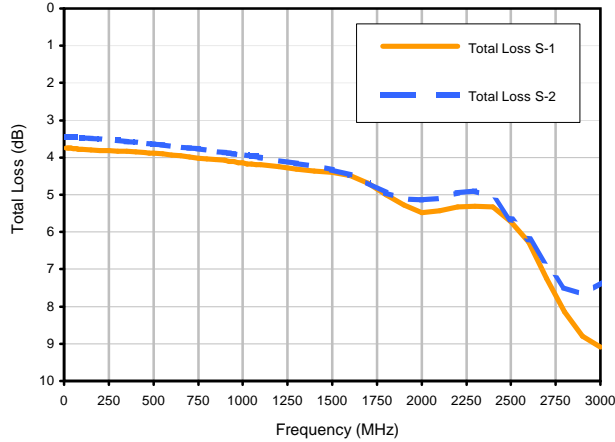

### Total Loss S-1 vs. TEMPERATURE

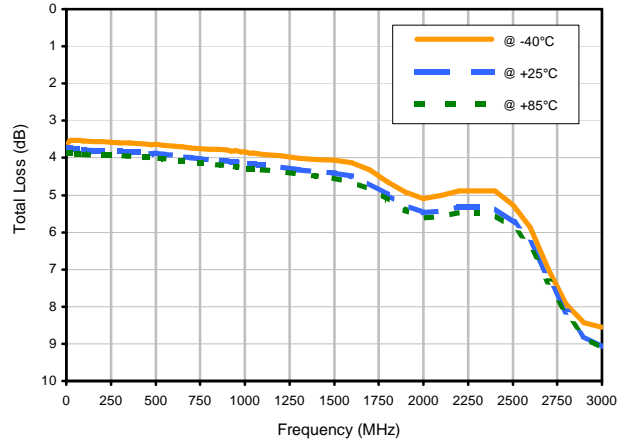

### Amplitude Unbalance vs. TEMPERATURE

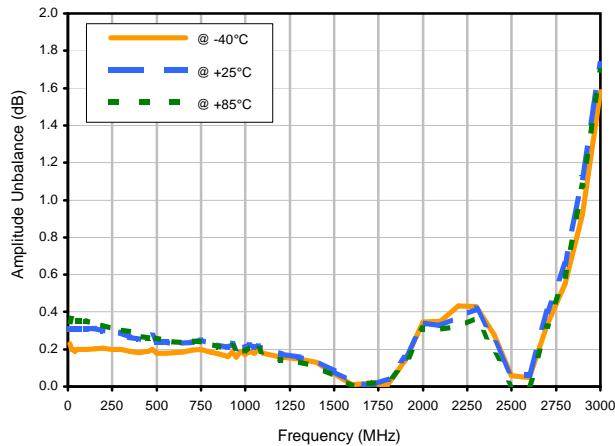

### Phase Unbalance vs. TEMPERATURE

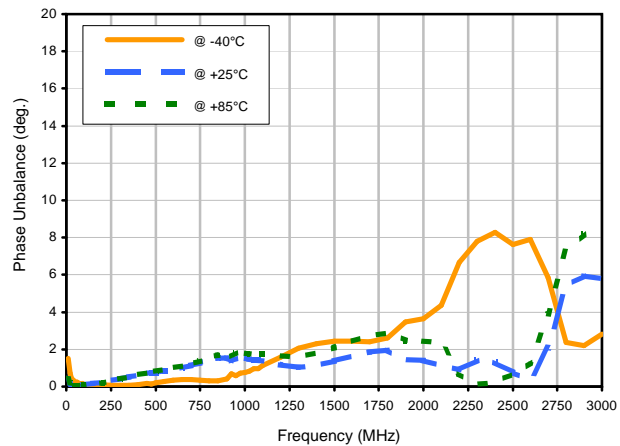

### Isolation 1-2 vs. TEMPERATURE

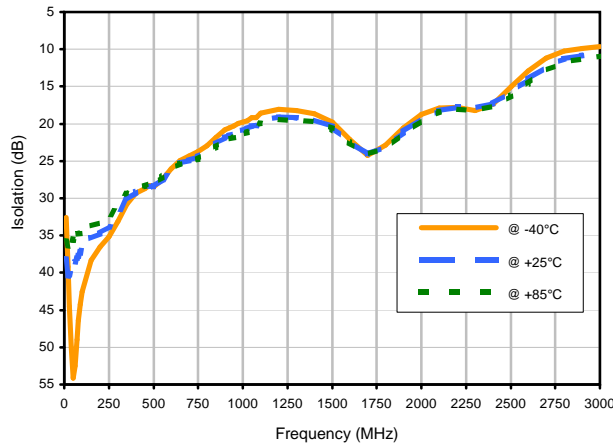

REV. X2

SBTC-2-10-75L+

100627

Page 1 of 2



IF/RF MICROWAVE COMPONENTS • ISO 9001 ISO 14001 AS 9100 CERTIFIED RoHS compliant

P.O. Box 350166, Brooklyn, New York 11235-0003 (718) 934-4500 Fax (718) 332-4661



The Design Engineers Search Engine finds the model you need, Instantly • For detailed performance specs & shopping online see



# 2 Way-0° Power Splitter/Combiner

# SBTC-2-10-75L+

## Typical Performance Curves

VSWR

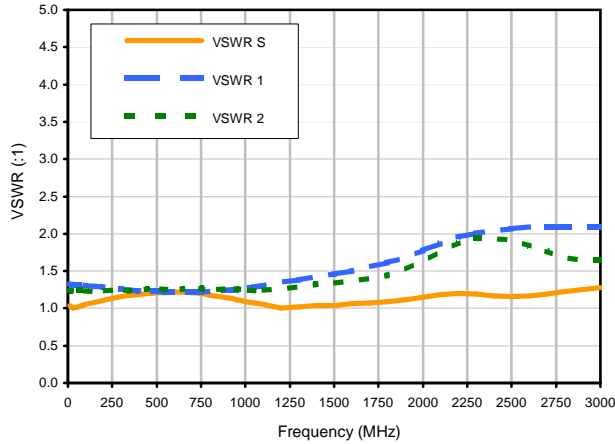

VSWR SUM vs. TEMPERATURE

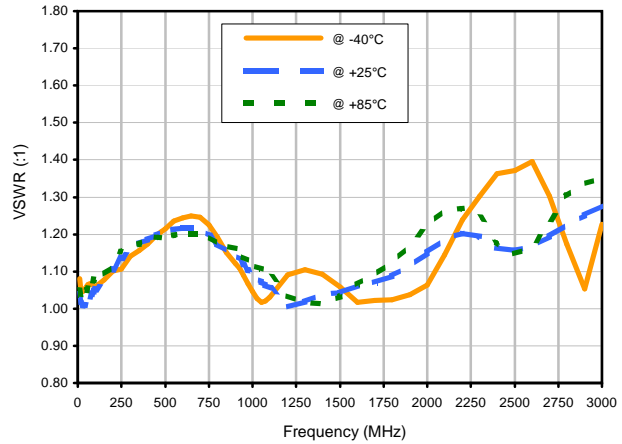

VSWR OUT1 vs. TEMPERATURE

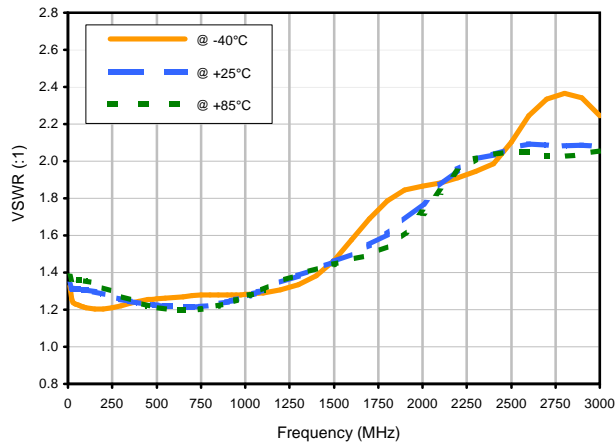

## Outline Dimensions

AT1029

## PCB Land Pattern

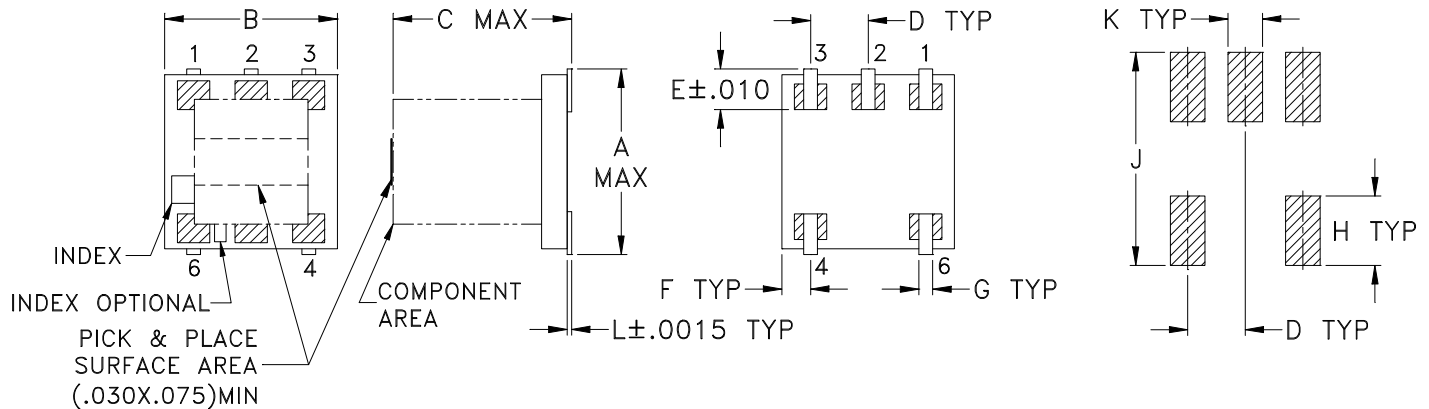

Suggested Layout,  
Tolerance to be within  $\pm .002$

CASE #	A	B	C	D	E	F	G	H	J	K	L	WT. GRAMS
AT1029	.166 (4.22)	.150 (3.81)	.155 (3.94)	.050 (1.27)	.037 (0.94)	.025 (0.64)	.012 (0.30)	.060 (1.52)	.184 (4.67)	.030 (0.76)	.004 (0.10)	.10

Dimensions are in inches (mm). Tolerances: 2 Pl.  $\pm .01$ ; 3 Pl.  $\pm .005$

### Notes:

- Open style, ceramic base.
- Termination finish:  
For RoHS Case Styles: Tin plate.  
For RoHS-5 Case Styles: Tin-Lead plate.



P.O. Box 350186, Brooklyn, New York 11235-0003 (718) 934-4500 Fax (718) 332-4661 For detailed performance specs & shopping online see Mini-Circuits web site



The Design Engineers Search Engine Provides ACTUAL Data Instantly From MINI-CIRCUITS At: [www.minicircuits.com](http://www.minicircuits.com)

RF/IF MICROWAVE COMPONENTS



# Tape & Reel Packaging TR-F76

## DEVICE ORIENTATION IN T&R

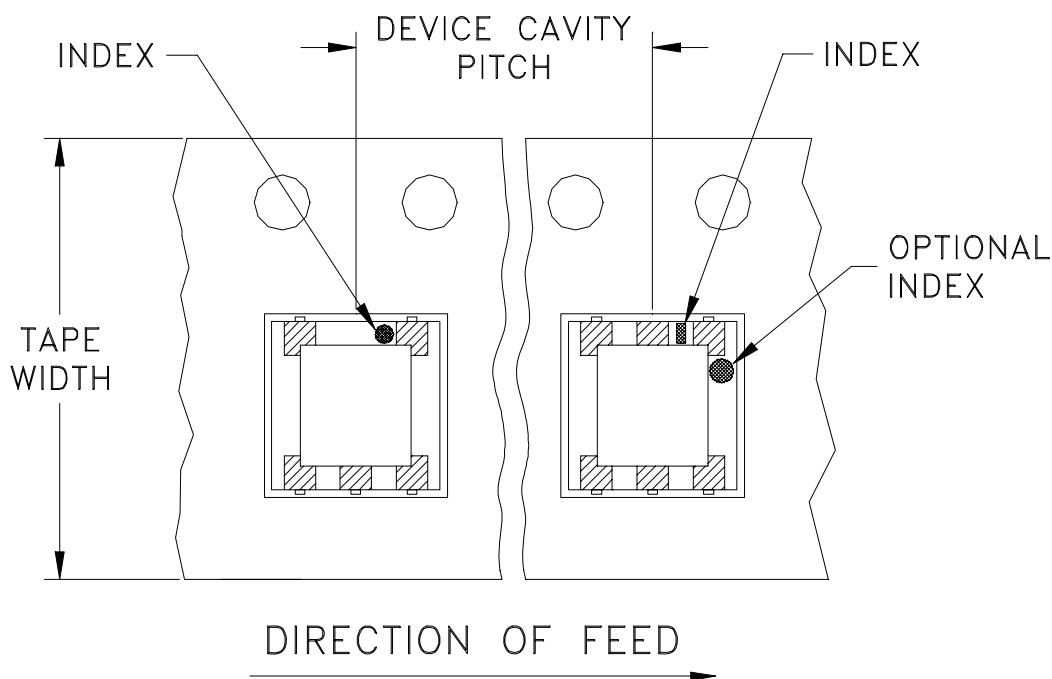

Tape Width, mm	Device Cavity Pitch, mm	Reel Size, inches	Devices per Reel
12	8	7	20
			50
			100
			200
			500
		13	1000
			2000

**Note:** Please consult individual model data sheet to determine device per reel availability.

Mini-Circuits carrier tape materials provide protection from ESD (Electro-Static Discharge) during handling and transportation. Tapes are static dissipative and comply with industry standards EIA-481/EIA-541.

Go to: [www.minicircuits.com/pages/pdfs/tape.pdf](http://www.minicircuits.com/pages/pdfs/tape.pdf)

**Mini-Circuits**<sup>®</sup>

INTERNET <http://www.minicircuits.com>

P.O. Box 350166, Brooklyn, New York 11235-0003 (718) 934-4500 Fax (718) 332-4661

Distribution Centers NORTH AMERICA 800-654-7949 • 417-335-5935 • Fax 417-335-5945 • EUROPE 44-1252-832600 • Fax 44-1252-837010

Mini-Circuits ISO 9001 & ISO 14001 Certified

THIRD ANGLE PROJECTION

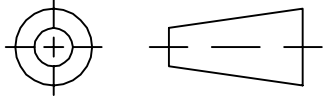

REVISIONS

REV	ECN No.	DESCRIPTION	DATE	DR	AUTH
OR	M90457	NEW RELEASE	01/16/04	AV	WP
A	M102713	ADDED "...WITH SMOBC"	01/12/06	GF	IL

SUGGESTED MOUNTING CONFIGURATION FOR AT1029 CASE STYLE, "nc" PIN CONNECTION

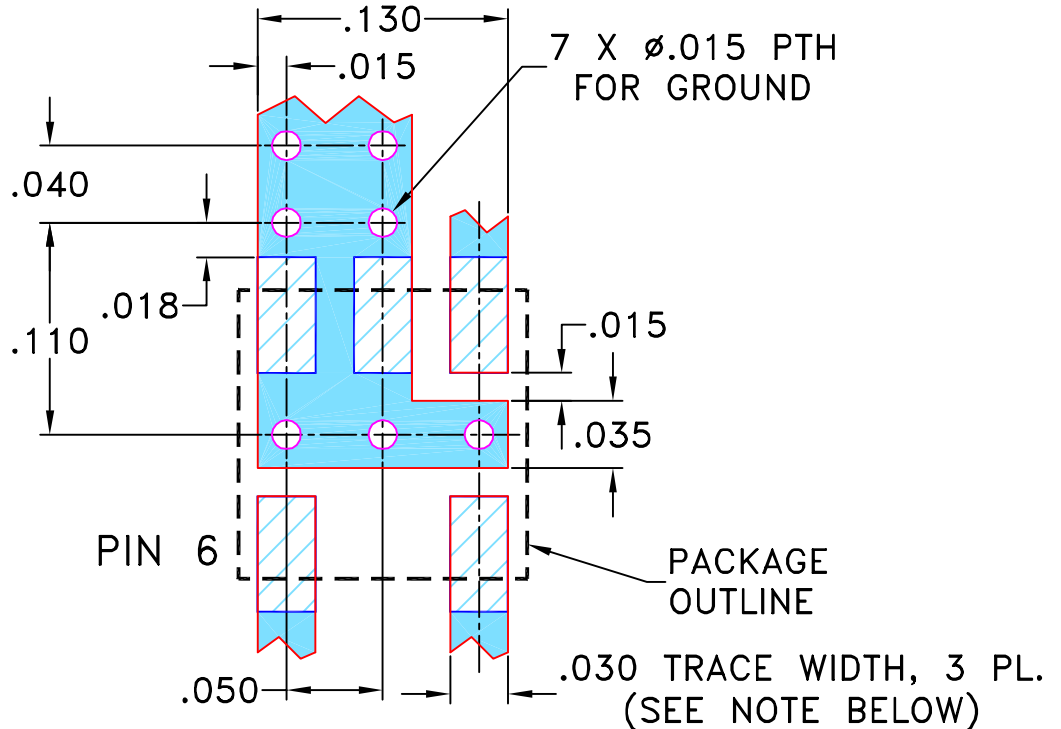

NOTE: 1. TRACE WIDTH IS SHOWN FOR ROGERS R04350B WITH DIELECTRIC THICKNESS 0.030" ± 0.002"; COPPER: 1/2 OZ. EACH SIDE. FOR OTHER MATERIALS TRACE WIDTH MAY NEED TO BE MODIFIED.

2. BOTTOM SIDE OF THE PCB IS CONTINUOUS GROUND PLANE.

- DENOTES PCB COPPER LAYOUT WITH SMOBC (SOLDER MASK OVER BARE COPPER)
- DENOTES COPPER LAND PATTERN FREE OF SOLDER MASK

UNLESS OTHERWISE SPECIFIED	INITIALS		DATE
DIMENSIONS ARE IN INCHES TOLERANCES ON: 2 PL DECIMALS ± 3 PL DECIMALS ± .005 ANGLES ± FRACTIONS ±	DRAWN	AV	01/07/04
	CHECKED	IL	01/16/04
	APPROVED	WP	01/16/04

**Mini-Circuits**<sup>®</sup> 13 Neptune Avenue  
Brooklyn NY 11235

PL, nc, 75, AT1029, SBTC, TB-277

Mini-Circuits<sup>®</sup>  
THIS DOCUMENT AND ITS CONTENTS ARE THE PROPERTY OF MINI-CIRCUITS. EXCEPT FOR USE EXPRESSLY GRANTED, IN WRITING, TO ITS VENDORS, VENDEE AND THE UNITED STATES GOVERNMENT, MINI-CIRCUITS RESERVES ALL PROPRIETARY DESIGN, USE, MANUFACTURING AND REPRODUCTION RIGHTS THERETO. THESE CONTENTS SHALL NOT BE USED, DUPLICATED OR DISCLOSED TO ANY OUTSIDE PARTY, IN WHOLE OR IN PART, WITHOUT WRITTEN PERMISSION OF MINI-CIRCUITS.

SIZE A	CODE IDENT 15542	DRAWING NO: 98-PL-153	REV: A
FILE: 98PL153	SCALE: 10:1	SHEET: 1 OF 1	

# Evaluation Board and Circuit

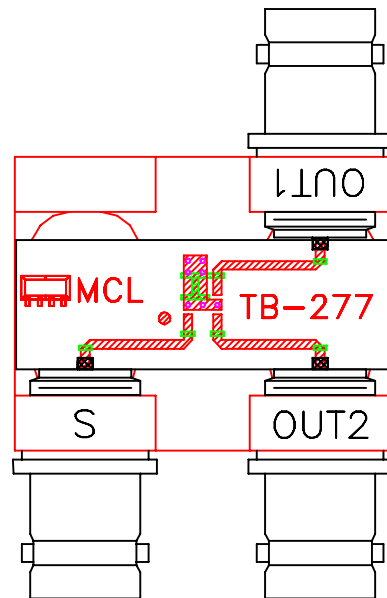

TB-277

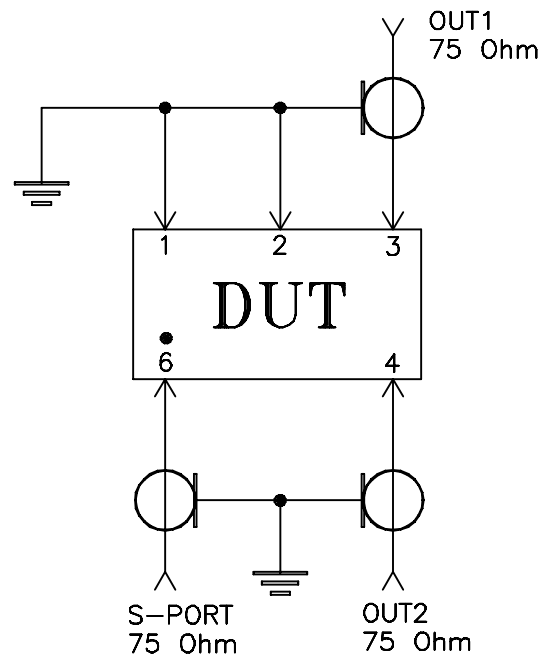

Schematic Diagram

## Notes:

1. 75 Ohm BNC Female connectors.
2. PCB Material: Rogers R04350 or equivalent,  
Dielectric Constant=3.5, Thickness=.030 inch.

 Mini-Circuits®



All Mini-Circuits products are manufactured under exacting quality assurance and control standards, and are capable of meeting published specifications after being subjected to any or all of the following physical and environmental test.

Specification	Test/Inspection Condition	Reference/Spec
Operating Temperature	-40° to 85°C Ambient Environment	Individual Model Data Sheet
Storage Temperature	-55° to 100° C Ambient Environment	Individual Model Data Sheet
Humidity	90 to 95% RH, 240 hours, 50°C	MIL-STD-202, Method 103, Condition A, Except 50°C and end-point electrical test done within 12 hours
Thermal Shock	-55° to 100°C, 100 cycles	MIL-STD-202, Method 107, Condition A-3, except +100°C
Solder Reflow Heat	Sn-Pb Eutetic Process: 225°C peak Pb-Free Process 245° - 250°C peak	J-STD-020, Table 4-1, 4-2 and 5-2, Figure 5-1
Solderability	10X Magnification	J-STD-002, 95% Coverage
Vibration (High Frequency)	20g peak, 10-2000 Hz, 12 times in each of three perpendicular directions (total 36)	MIL-STD-202, Method 204, Condition D
Mechanical Shock	50g, 11 ms, 1/2-sine, 18 shocks: 3 each direction, each of 3 axes	MIL-STD-202, Method 213, Condition A
Marking Resistance to Solvents	Isopropyl alcohol + mineral spirits at 25°C; terpene defluxer at 25°C; distilled water + proylene glycol monomethyl ether + monoethanolamine at 63°C to 70°C	MIL-STD-202, Method 215