



ULTRA LOW NOISE, MEDIUM CURRENT

E-PHEMT Transistor

SAV-581+

0.045-6GHz

THE BIG DEAL

- Low Noise Figure, 0.5 dB
- Gain, 17 dB at 2 GHz
- High Output IP3, +30 dBm
- Output Power at 1dB comp., +20 dBm
- Medium Current, 30mA
- Wide bandwidth
- External biasing and matching required
- May be used as replacement ^{a,b} for Avago ATF-58143



Generic photo used for illustration purposes only

CASE STYLE: MMM1362

+RoHS Compliant

The +Suffix identifies RoHS Compliance. See our web site for RoHS Compliance methodologies and qualifications

APPLICATIONS

- Cellular
- ISM
- GSM
- WCDMA
- WiMax
- WLAN
- UNII and HIPERLAN

GENERAL DESCRIPTION

SAV-581+ is an ultra-low noise, high IP3 transistor device, manufactured using E-PHEMT* technology enabling it to work with a single positive supply voltage. It has outstanding Noise Figure, particularly below 2.5 GHz, and when combining this noise figure with high IP3 performance in a single device it makes it an ideal amplifier for demanding base station applications. We offer these units assembled into a complete module, 50Ω in/out, noise matched and fully specified. For more information please see our TAMP family of models on our web site.

SIMPLIFIED SCHEMATIC AND PIN DESCRIPTION

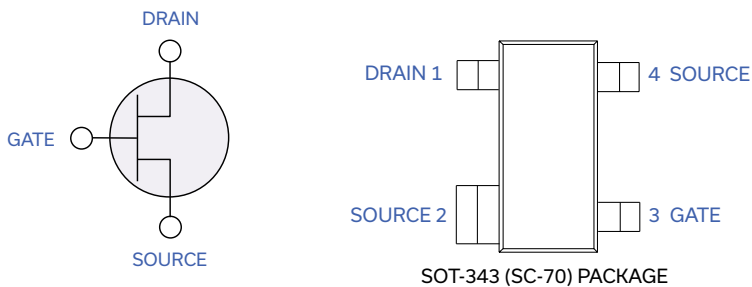

Function	Pin Number	Description
Source	2 & 4	Source terminal, normally connected to ground
Gate	3	Gate used for RF Input
Drain	1	Drain used for RF output

* Enhancement mode Pseudomorphic High Electron Mobility Transistor.

a. Suitability for model replacement within a particular system must be determined by and is solely the responsibility of the customer based on, among other things, electrical performance criteria, stimulus conditions, application, compatibility with other components and environmental conditions and stresses.

b. The Avago ATF-54143 part number is used for identification and comparison purposes only

REV. F
ECO-010314
SAV-581+
211025





ULTRA LOW NOISE, MEDIUM CURRENT

E-PHEMT Transistor

SAV-581+

ELECTRICAL SPECIFICATIONS AT $T_{AMB}=25^{\circ}\text{C}$, FREQUENCY 0.045 TO 6 GHz

Symbol	Parameter	Condition	Min.	Typ.	Max.	Units	
DC Specifications							
V_{GS}	Operational Gate Voltage	$V_{DS}=3\text{V}, I_{DS}=30\text{ mA}$	0.28	0.39	0.5	V	
V_{TH}	Threshold Voltage	$V_{DS}=3\text{V}, I_{DS}=4\text{ mA}$	0.18	0.26	0.38	V	
I_{DSS}	Saturated Drain Current	$V_{DS}=3\text{V}, V_{GS}=0\text{ V}$		1.0	5.0	μA	
G_M	Transconductance	$V_{DS}=3\text{V}, G_m=\Delta I_{DS}/\Delta V_{GS}$ $\Delta V_{GS}=V_{GS1}-V_{GS2}$ $V_{GS1}=V_{GS}$ at $I_{DS}=30\text{ mA}$ $V_{GS2}=V_{GS1}+0.05\text{V}$	— — 230 —	— — 327 —	— — 560 —	mS	
I_{GSS}	Gate leakage Current	$V_{GD}=V_{GS}=-3\text{V}$			200	μA	
RF Specifications, $Z_0=50\text{ Ohms}$ (Figure 1)							
NF ⁽¹⁾	Noise Figure	$V_{DS}=3\text{V}, I_{DS}=30\text{ mA}$	f=0.9 GHz		0.4	—	dB
			f=2.0 GHz		0.5	0.9	
			f=3.9 GHz		0.8	—	
			f=5.8 GHz		1.5	—	
			f=2.0 GHz		0.5	—	
Gain	Gain	$V_{DS}=4\text{V}, I_{DS}=30\text{ mA}$	f=0.9 GHz		0.4	—	dB
			f=2.0 GHz		0.5	—	
			f=3.9 GHz		12.0	—	
			f=5.8 GHz		8.3	—	
			f=2.0 GHz		17.0	—	
OIP3	Output IP3	$V_{DS}=3\text{V}, I_{DS}=30\text{ mA}$	f=0.9 GHz	—	28.6	—	dBm
			f=2.0 GHz	27.0	30.6	—	
			f=3.9 GHz	—	35.2	—	
			f=5.8 GHz	—	39.3	—	
			f=2.0 GHz	—	30.3	—	
P1dB ⁽²⁾	Power output at 1 dB Compression	$V_{DS}=3\text{V}, I_{DS}=30\text{ mA}$	f=0.9 GHz		18.5	—	dBm
			f=2.0 GHz		19.0	—	
			f=3.9 GHz		19.2	—	
			f=5.8 GHz		18.1	—	
			f=2.0 GHz		20.5	—	
		$V_{DS}=4\text{V}, I_{DS}=30\text{ mA}$	f=0.9 GHz		18.5	—	dBm
			f=2.0 GHz		19.0	—	
			f=3.9 GHz		19.2	—	
			f=5.8 GHz		18.1	—	
			f=2.0 GHz		20.5	—	

MAXIMUM RATINGS⁽³⁾

Symbol	Parameter	Max.	Units
V_{DS} ⁽⁴⁾	Drain-Source Voltage	5	V
V_{GS} ⁽⁴⁾	Gate-Source Voltage	-5 to 0.7	V
V_{GD} ⁽⁴⁾	Gate-Drain Voltage	-5 to 0.7	V
I_{DS} ⁽⁴⁾	Drain Current	100	mA
I_{GS}	Gate Current	2	mA
P_{DISS}	Total Dissipated Power	500	mW
P_{IN} ⁽⁵⁾	RF Input Power	17	dBm
T_{CH}	Channel Temperature	150	$^{\circ}\text{C}$
T_{OP}	Operating Temperature	-40 to 85	$^{\circ}\text{C}$
T_{STD}	Storage Temperature	-65 to 150	$^{\circ}\text{C}$
Θ_{JC}	Thermal Resistance	160	$^{\circ}\text{C}/\text{W}$

Notes:

- (1) Includes test board loss (tested on Mini-Circuits TB-471+ test board)
- (2) During Compression, I_{DS} was allowed to increase.
- (3) Operation of this device above any one of these parameters may cause permanent damage.
- (4) Assumes DC quiescent conditions.
- (5) I_{GS} is limited to 2 mA during test.





CHARACTERIZATION TEST CIRCUIT

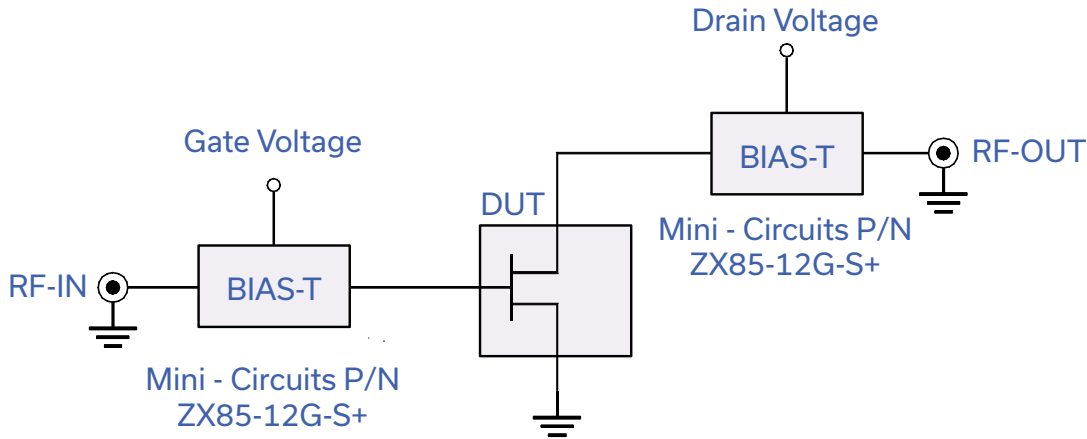

Fig 1. Block Diagram of Test Circuit used for characterization. (DUT soldered on Mini-Circuits Test Board TB-471+)

Gain, Output power at 1dB compression (P1 dB) and output IP3 (OIP3) are measured using R&S Network Analyzer ZVA-24. Noise Figure measured using Agilent Noise Figure meter N8975A and Noise Source N4000A.

Conditions:

1. Drain voltage (with reference to source, VDS)= 3 or 4V as shown.
2. Gate Voltage (with reference to source, VGS) is set to obtain desired Drain-Source current (IDS) as shown in graphs or specification table.
3. Gain: Pin= -25dBm
4. Output IP3 (OIP3): Two tones, spaced 1 MHz apart, 0 dBm/tone at output.
5. No external matching components used.

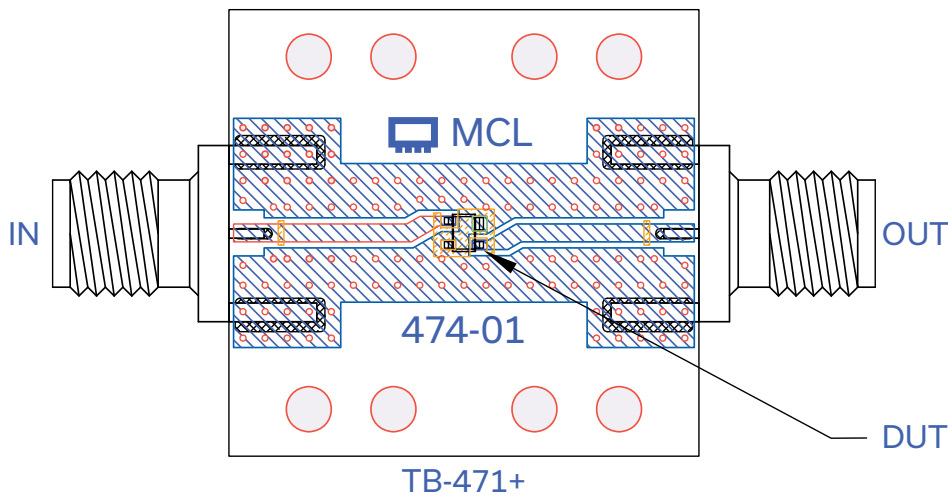
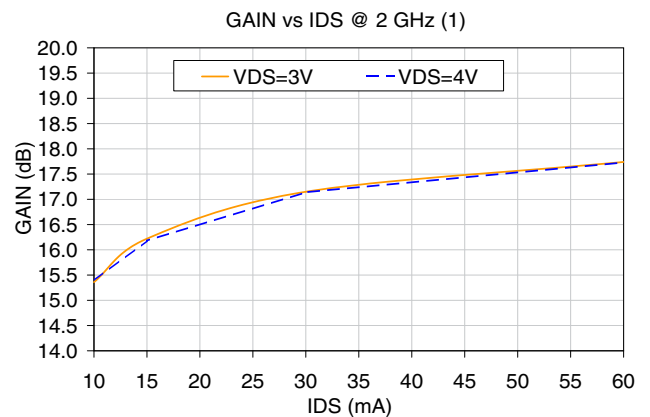
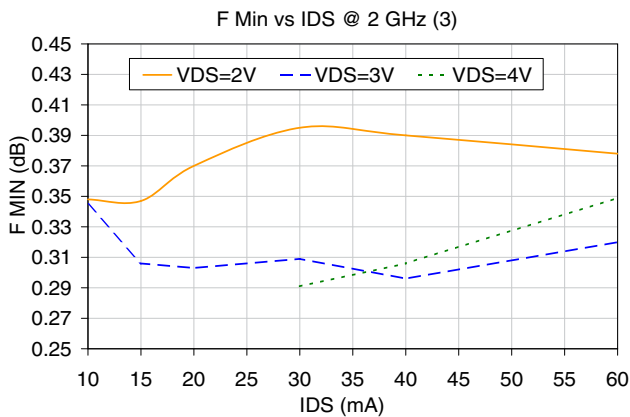
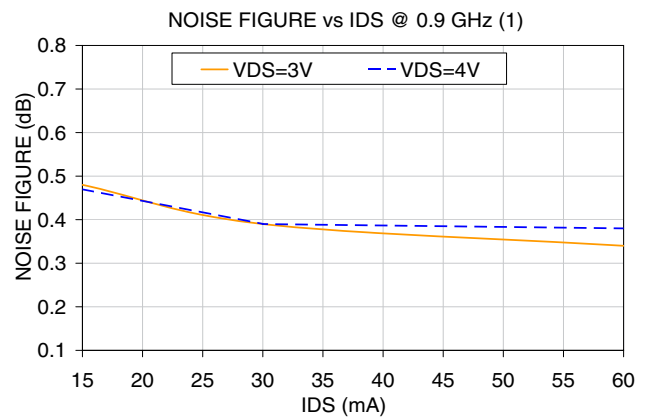
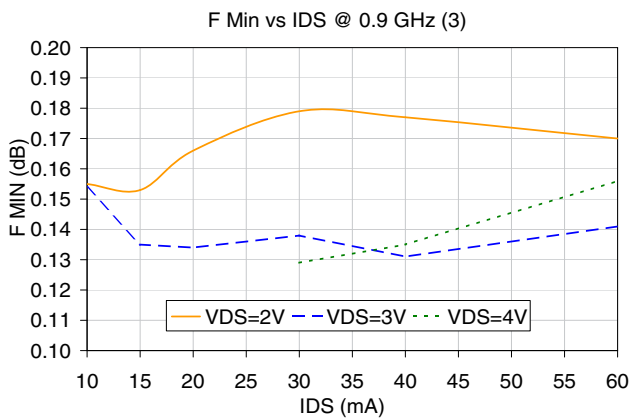
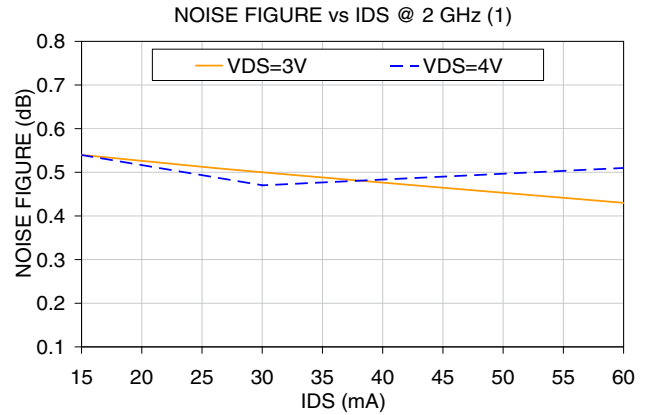
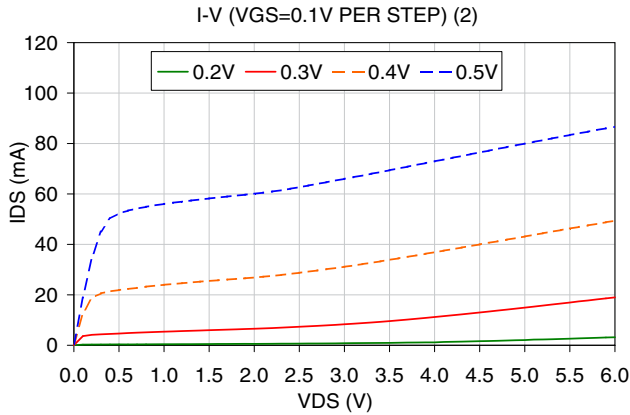

Fig 2. Test Board used for characterization, Mini-Circuits P/N TB-471+ (Material: Rogers 4350, Thickness: 0.02")



TYPICAL PERFORMANCE CURVES



(1) Includes test board loss, set-up and conditions per Figure 1.
 (2) Measured using HP4155B semiconductor parameter analyzer.
 (3) F Min is minimum Noise Figure.
 (4) Drain current was allowed to increase during compression measurement.



TYPICAL PERFORMANCE CURVES

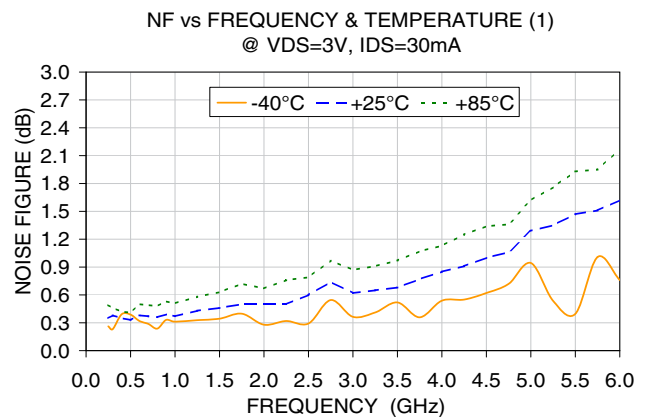
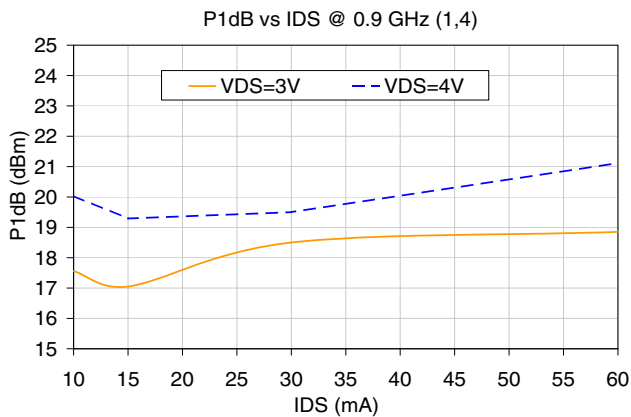
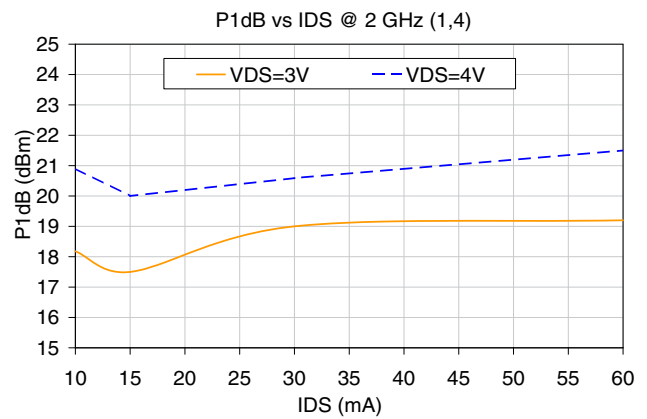
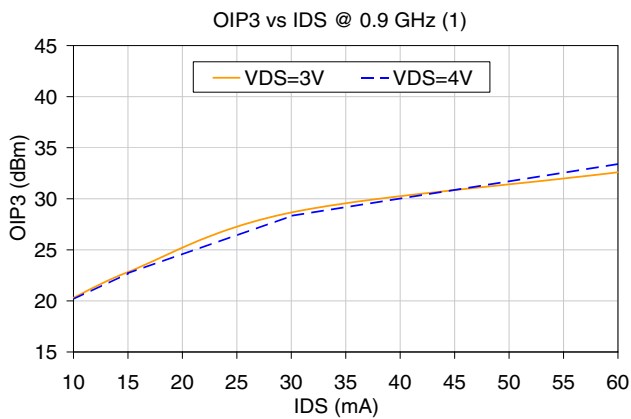
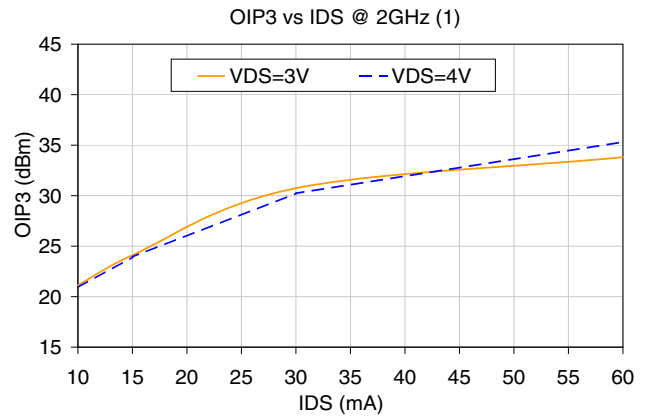
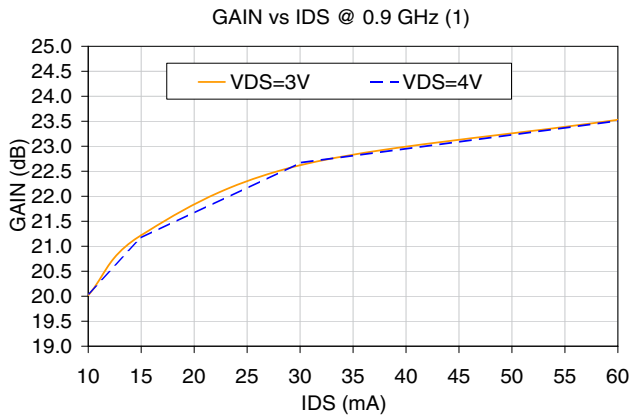

(1) Includes test board loss, set-up and conditions per Figure 1.
 (2) Measured using HP4155B semiconductor parameter analyzer.
 (3) F Min is minimum Noise Figure.
 (4) Drain current was allowed to increase during compression measurement.



TYPICAL PERFORMANCE CURVES

GAIN vs FREQUENCY & TEMPERATURE (1)
@ VDS=3V, IDS=30mA

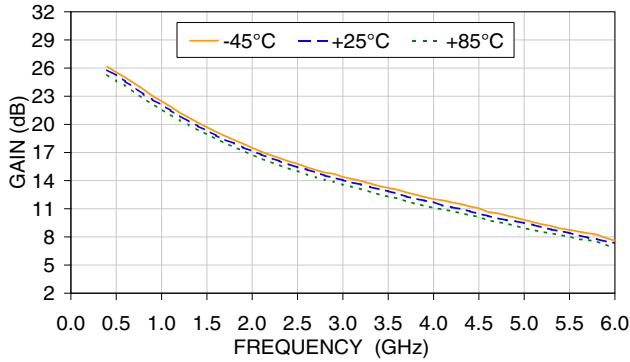

OIP3 vs FREQUENCY & TEMPERATURE (1)
@ VDS=3V, IDS=30mA

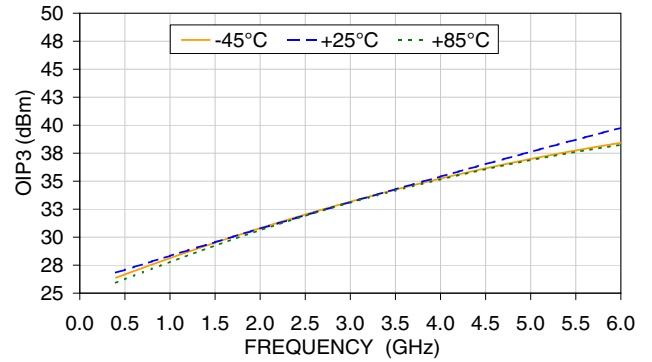

P1dB vs FREQUENCY & TEMPERATURE (1,4)
@ VDS=3V, IDS=30mA

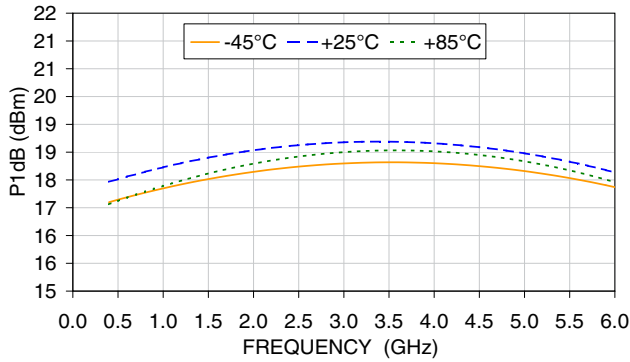

NF vs FREQUENCY & TEMPERATURE (1)
@ VDS=4V, IDS=30mA

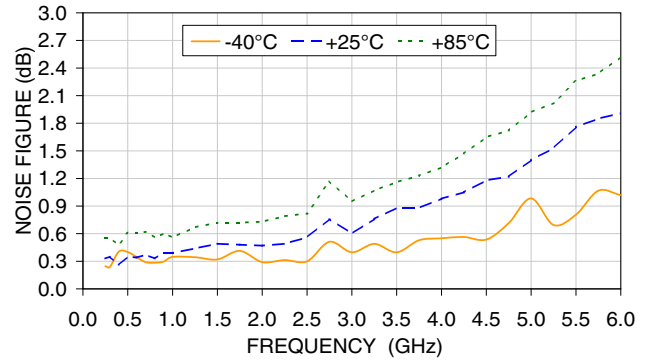

GAIN vs FREQUENCY & TEMPERATURE (1)
@ VDS=4V, IDS=30mA

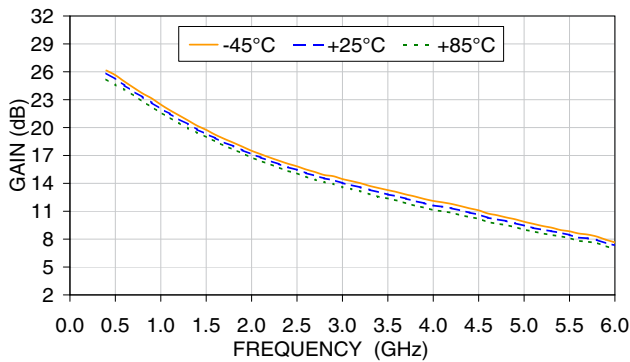

OIP3 vs FREQUENCY & TEMPERATURE (1)
@ VDS=4V, IDS=30mA

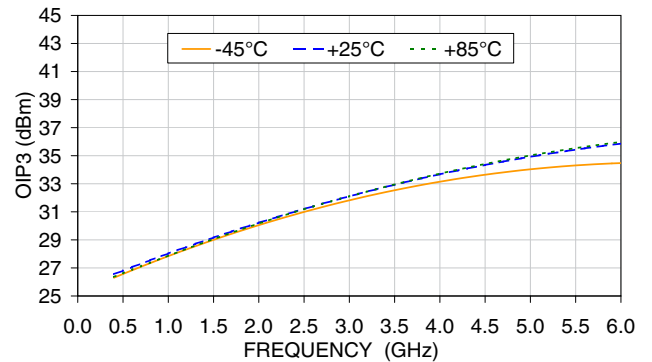

(1) Includes test board loss, set-up and conditions per Figure 1.
 (2) Measured using HP4155B semiconductor parameter analyzer.
 (3) F Min is minimum Noise Figure.
 (4) Drain current was allowed to increase during compression measurement.



ULTRA LOW NOISE, MEDIUM CURRENT E-PHEMT Transistor

SAV-581+

TYPICAL PERFORMANCE CURVES

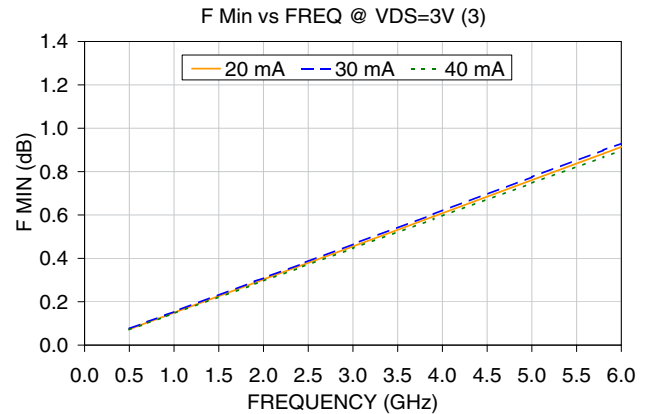
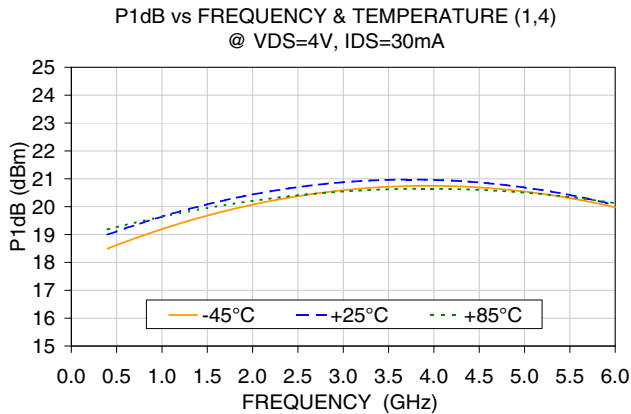

- (1) Includes test board loss, set-up and conditions per Figure 1.
- (2) Measured using HP4155B semiconductor parameter analyzer.
- (3) F Min is minimum Noise Figure.
- (4) Drain current was allowed to increase during compression measurement.

REFERENCE PLANE LOCATION FOR S AND NOISE PARAMETERS

(see data in pages 8-11) (Refer to Application Note AN-60-040)

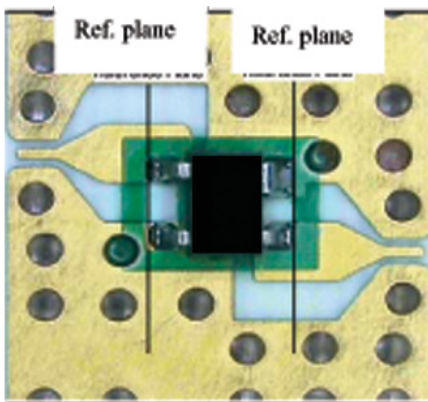

Fig 3. Reference Plane Location

Noise parameters were measured over 0.5 to 6 GHz by Modelithics® using a solid state tuner-based noise parameter (NP) test system available from Maury Microwave. F Min, optimum source reflection coefficient and noise resistance values are calculated values based on a set of measurements made at approximately 16 different impedances. Some data smoothing was applied to arrive at the presented data set.

S-parameters were measured by Modelithics® on an Anritsu Lightning vector network analyzer over 0.1 to 18GHz using 350um pitch RF probes from GGB industries combined with customized thru-reflect-line (TRL) calibration standards. The reference plane is at the device package leads, as shown in the picture.



TYPICAL S-PARAMETERS, $V_{DS}=3V$ AND $I_{DS}=30 MA$ (FIG. 3)

Freq. (GHz)	S11		S21			S12		S22		MSG/MAG (dB)
	Mag.	Ang.	Mag.	Mag (dB)	Ang.	Mag.	Ang.	Mag.	Ang.	
0.1	1.00	-16.12	22.99	27.23	169.9	0.009	80.2	0.58	-11.8	33.9
0.5	0.88	-71.50	18.31	25.25	134.0	0.037	53.6	0.47	-50.9	27.0
0.9	0.77	-109.23	13.52	22.62	110.7	0.05	40.2	0.35	-77.5	24.3
1.0	0.75	-117.04	12.59	22.00	106.1	0.052	37.3	0.33	-83.3	23.8
1.5	0.69	-146.73	9.21	19.28	87.9	0.06	29.0	0.25	-106.3	21.8
1.9	0.67	-164.32	7.50	17.50	76.3	0.065	25.0	0.21	-122.4	20.6
2.0	0.67	-168.10	7.16	17.10	73.7	0.066	24.1	0.20	-126.2	20.3
2.5	0.66	174.78	5.83	15.31	61.6	0.073	20.2	0.17	-144.2	19.1
3.0	0.66	160.26	4.91	13.81	50.6	0.078	16.4	0.16	-161.5	18.0
4.0	0.67	135.52	3.71	11.38	30.1	0.091	9.3	0.15	165.0	16.1
5.0	0.69	114.29	2.96	9.43	10.9	0.103	0.6	0.17	136.7	13.2
6.0	0.72	95.32	2.44	7.75	-7.4	0.116	-8.9	0.21	113.4	11.6
7.0	0.75	78.30	2.05	6.23	-25.2	0.127	-19.5	0.26	94.1	10.4
8.0	0.78	62.75	1.74	4.82	-42.2	0.137	-30.0	0.32	77.6	9.5
9.0	0.82	48.10	1.48	3.43	-58.7	0.144	-41.3	0.38	62.4	8.9
10.0	0.85	33.92	1.27	2.08	-74.9	0.148	-52.9	0.45	48.2	8.6
11.0	0.88	20.72	1.09	0.77	-90.5	0.151	-64.4	0.51	35.1	8.6
12.0	0.90	8.48	0.95	-0.46	-105.3	0.152	-75.7	0.57	22.9	8.0
13.0	0.91	-3.35	0.84	-1.55	-119.8	0.153	-87.1	0.62	11.9	7.4
14.0	0.92	-14.29	0.74	-2.58	-133.5	0.153	-97.7	0.66	1.4	6.9
15.0	0.94	-22.84	0.64	-3.85	-144.6	0.148	-106.4	0.70	-7.5	6.4
16.0	0.95	-30.29	0.55	-5.26	-154.6	0.138	-114.2	0.75	-15.6	6.0
17.0	0.95	-38.87	0.48	-6.36	-165.6	0.133	-122.5	0.78	-24.3	5.6
18.0	0.95	-48.16	0.43	-7.26	-177.3	0.131	-131.4	0.79	-33.1	5.2

MAXIMUM STABLE GAIN (MSG)/MAXIMUM AVAILABLE GAIN (MAG) vs. FREQUENCY

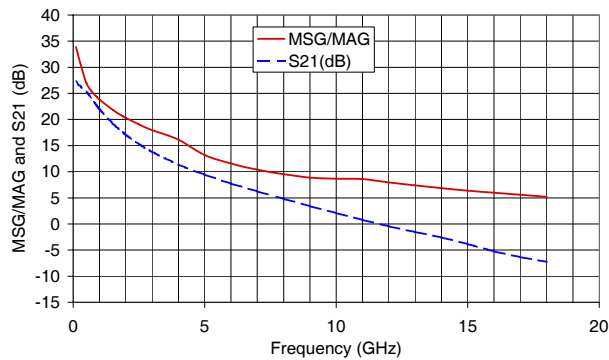

TYPICAL NOISE PARAMETERS, $V_{DS}=3V$ AND $I_{DS}=30 MA$ (FIG. 3)

Freq. (GHz)	F Min. (dB)	GOpt (Magnitude)	GOpt (Angle)	Rn/50	Ga Associated Gain (dB)
0.5	0.076	0.33	41.65	0.06	28.7
0.7	0.107	0.34	50.02	0.05	26.4
0.9	0.138	0.35	58.35	0.05	24.4
1.0	0.154	0.35	62.50	0.04	23.5
1.9	0.294	0.38	99.47	0.03	18.2
2.0	0.309	0.38	103.54	0.03	17.8
2.4	0.371	0.40	119.71	0.03	16.3
3.0	0.465	0.42	143.69	0.04	14.7
3.9	0.604	0.45	179.08	0.05	12.9
5.0	0.775	0.49	-138.64	0.09	11.6
5.8	0.899	0.51	-108.56	0.13	10.8
6.0	0.930	0.52	-101.13	0.14	10.6

Notes:
 F Min.: Minimum Noise Figure
 GOpt: Optimum Source Reflection Coefficient
 Rn: Equivalent noise resistance



ULTRA LOW NOISE, MEDIUM CURRENT

E-PHEMT Transistor

SAV-581+

Mini-Circuits

TYPICAL S-PARAMETERS, $V_{DS}=4V$ AND $I_{DS}=30\text{ MA}$ (FIG. 3)

Freq. (GHz)	S11		S21			S12		S22		MSG/MAG (dB)
	Mag.	Ang.	Mag.	Mag (dB)	Ang.	Mag.	Ang.	Mag.	Ang.	
0.1	1.00	-15.90	23.03	27.25	169.8	0.01	82.5	0.60	-12.0	33.8
0.5	0.88	-70.97	18.35	25.27	134.2	0.036	56.5	0.48	-49.1	27.1
0.9	0.77	-108.70	13.57	22.65	110.9	0.05	40.3	0.36	-74.0	24.4
1.0	0.75	-116.55	12.65	22.04	106.3	0.051	37.7	0.34	-79.4	23.9
1.5	0.69	-146.18	9.26	19.33	88.0	0.059	29.3	0.25	-100.9	21.9
1.9	0.67	-163.86	7.54	17.55	76.4	0.064	25.0	0.21	-115.8	20.7
2.0	0.67	-167.69	7.20	17.15	73.8	0.065	24.0	0.20	-119.3	20.4
2.5	0.66	175.19	5.87	15.37	61.7	0.071	20.5	0.17	-136.4	19.2
3.0	0.65	160.62	4.94	13.87	50.7	0.077	17.0	0.15	-153.2	18.1
4.0	0.66	135.88	3.73	11.44	30.2	0.089	9.6	0.14	172.5	16.2
5.0	0.68	114.61	2.99	9.50	11.0	0.101	1.2	0.15	142.0	13.3
6.0	0.71	95.65	2.46	7.83	-7.4	0.114	-8.1	0.19	117.1	11.7
7.0	0.75	78.58	2.07	6.33	-25.2	0.126	-18.3	0.24	97.0	10.5
8.0	0.78	63.09	1.76	4.92	-42.3	0.135	-28.8	0.30	80.0	9.7
9.0	0.82	48.41	1.50	3.54	-58.9	0.143	-40.2	0.36	64.5	9.1
10.0	0.85	34.23	1.29	2.20	-75.3	0.148	-51.7	0.44	50.0	9.0
11.0	0.88	20.98	1.11	0.88	-90.9	0.15	-63.2	0.50	36.7	8.7
12.0	0.90	8.74	0.96	-0.34	-105.9	0.152	-74.7	0.56	24.5	8.0
13.0	0.91	-3.13	0.85	-1.45	-120.5	0.154	-86.0	0.61	13.3	7.4
14.0	0.93	-14.07	0.75	-2.49	-134.3	0.154	-96.9	0.65	2.7	6.9
15.0	0.94	-22.62	0.65	-3.79	-145.6	0.148	-105.4	0.70	-6.4	6.4
16.0	0.95	-30.07	0.55	-5.21	-155.7	0.139	-113.4	0.74	-14.6	6.0
17.0	0.95	-38.63	0.48	-6.34	-166.7	0.133	-121.7	0.78	-23.4	5.6
18.0	0.95	-47.84	0.43	-7.26	-178.4	0.131	-131.1	0.79	-32.3	5.2

MAXIMUM STABLE GAIN (MSG)/MAXIMUM AVAILABLE GAIN (MAG) vs. FREQUENCY

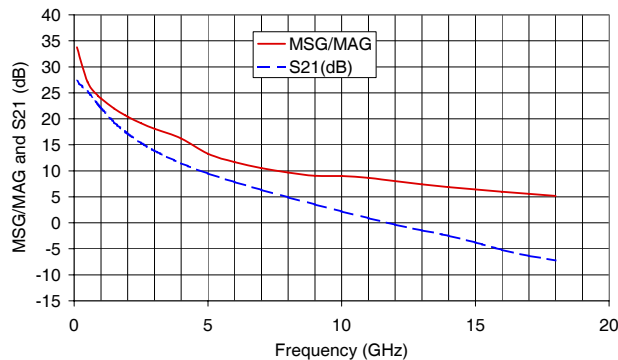

Notes:
 F Min.: Minimum Noise Figure
 GOpt: Optimum Source Reflection Coefficient
 Rn: Equivalent noise resistance

TYPICAL NOISE PARAMETERS, $V_{DS}=4V$ AND $I_{DS}=30\text{ MA}$ (FIG. 3)

Freq. (GHz)	F Min. (dB)	GOpt (Magnitude)	GOpt (Angle)	Rn/50	Ga Associated Gain (dB)
0.5	0.070	0.37	25.83	0.06	27.6
0.7	0.099	0.37	35.87	0.05	25.4
0.9	0.129	0.38	45.79	0.05	23.6
1.0	0.143	0.38	50.71	0.05	22.8
1.9	0.276	0.41	93.56	0.03	17.8
2.0	0.291	0.41	98.16	0.03	17.5
2.4	0.349	0.42	116.28	0.03	16.1
3.0	0.438	0.43	142.54	0.04	14.6
3.9	0.570	0.46	179.85	0.05	13.0
5.0	0.732	0.48	-137.93	0.09	11.7
5.8	0.850	0.50	-109.57	0.13	10.8
6.0	0.879	0.50	-102.79	0.15	10.5





ULTRA LOW NOISE, MEDIUM CURRENT E-PHEMT Transistor

SAV-581+

RECOMMENDED APPLICATION CIRCUIT

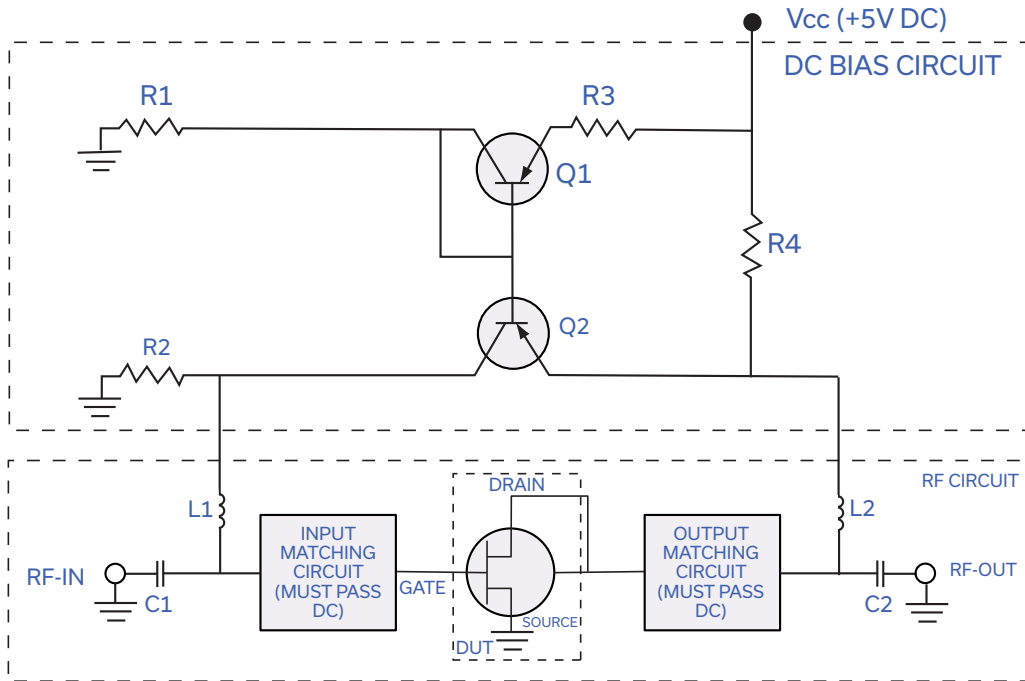

VDS, V (nom)	3	4
IDS, mA (nom)	30mA	30mA
R1	4320Ω	4320Ω
R2	4320Ω	4320Ω
R3	3570Ω	1210Ω
R4	68.1Ω	33.2Ω
Q1	MMBT3906*	MMBT3906*
Q2	MMBT3906*	MMBT3906*
C1	0.01μF	0.01μF
C2	0.01μF	0.01μF
L1**	840nH	840nH
L2**	840nH	840nH

*Fairchild Semiconductor™ part number
**Piconics™ part number CC45T47K240G5

OPTIMIZED AMPLIFIER CIRCUITS

For band specific, drop-in modules, and as an alternative to designing circuits, please refer to Mini-Circuits TAMP and RAMP series models which are based upon SAV/TAV E-PHEMT's and include all DC blocking, bias, matching and stabilization circuitry, without need for any external components.

PRODUCT MARKING

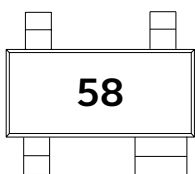



ADDITIONAL DETAILED TECHNICAL INFORMATION IS AVAILABLE ON OUR DASH BOARD. TO ACCESS [CLICK HERE](#)

Performance Data	Data Table Swept Graphs Performance data, graphs, s-parameter data set (.zip file)
Case Style	MMM1362 Plastic molded SOT-343 (SC-70) style package, lead finish: matte tin
Tape & Reel Standard quantities available on reel	F90 Standard quantities available on reel: 7" reels with 20, 50, 100, 200, 500, 1K, 2K, or 3K devices.
Suggested Layout for PCB Design	PL-300
Evaluation Board	TB-471+
Environmental Ratings	ENV08T2

ESD RATING

Human Body Model (HBM): Class 1A (250 V to < 500 V) in accordance with ANSI/ESD STM 5.1 - 2001

Machine Model (MM): Class M1 (40 V) in accordance with ANSI/ESD STM 5.2 - 1999

MSL RATING

Moisture Sensitivity: MSL1 in accordance with IPC/JEDECJ-STD-020D

MSL TEST FLOW CHART

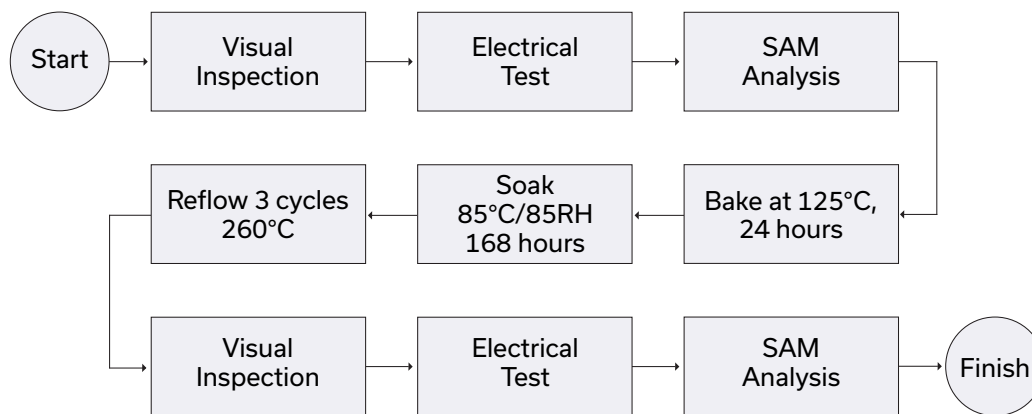

- NOTES**
- A. Performance and quality attributes and conditions not expressly stated in this specification document are intended to be excluded and do not form a part of this specification document.
 - B. Electrical specifications and performance data contained in this specification document are based on Mini-Circuit's applicable established test performance criteria and measurement instructions.
 - C. The parts covered by this specification document are subject to Mini-Circuits standard limited warranty and terms and conditions (collectively, "Standard Terms"); Purchasers of this part are entitled to the rights and benefits contained therein. For a full statement of the standard. Terms and the exclusive rights and remedies thereunder, please visit Mini-Circuits' website at www.minicircuits.com/MCLStore/terms.jsp

Typical Performance Data

VDS (V)	IDS (mA)				
	@ VGS=				
	0.20V	0.30V	0.40V	0.50V	0.60V
0.00	0.01	0.04	0.08	0.08	0.10
0.10	0.27	3.65	12.61	18.97	21.95
0.20	0.29	4.15	18.82	34.57	42.39
0.30	0.30	4.34	20.58	45.11	60.56
0.40	0.33	4.50	21.37	50.24	75.24
0.50	0.34	4.65	21.90	52.30	85.18
0.60	0.34	4.85	22.33	53.38	90.38
0.70	0.36	4.99	22.76	54.18	92.66
0.80	0.38	5.13	23.24	54.89	93.88
0.90	0.40	5.25	23.62	55.49	94.80
1.00	0.42	5.38	23.97	56.03	95.53
1.10	0.43	5.51	24.29	56.51	96.14
1.20	0.45	5.63	24.61	56.97	96.68
1.30	0.45	5.75	24.91	57.39	97.18
1.40	0.47	5.86	25.22	57.82	97.65
1.50	0.48	5.98	25.50	58.21	98.08
1.60	0.52	6.10	25.77	58.60	98.49
1.70	0.53	6.21	26.04	58.97	98.89
1.80	0.55	6.32	26.32	59.33	99.30
1.90	0.57	6.45	26.58	59.70	99.68
2.00	0.55	6.55	26.87	60.08	100.07
2.10	0.58	6.69	27.17	60.50	100.48
2.20	0.60	6.82	27.51	60.97	100.97
2.30	0.63	6.99	27.89	61.47	101.50
2.40	0.64	7.17	28.29	62.05	102.12
2.50	0.67	7.34	28.74	62.68	102.78
2.60	0.70	7.52	29.19	63.32	103.50
2.70	0.71	7.69	29.65	63.99	104.22
2.80	0.73	7.90	30.15	64.64	104.94
2.90	0.76	8.10	30.62	65.31	105.64
3.00	0.82	8.34	31.13	65.99	106.33
3.10	0.84	8.56	31.63	66.65	107.02
3.20	0.87	8.79	32.17	67.32	107.70
3.30	0.90	9.03	32.72	68.02	108.37
3.40	0.92	9.30	33.28	68.69	109.02
3.50	0.95	9.58	33.87	69.41	109.67
3.60	1.01	9.89	34.46	70.12	110.34
3.70	1.06	10.20	35.06	70.81	111.00
3.80	1.10	10.53	35.67	71.53	111.64
3.90	1.14	10.86	36.29	72.24	112.30
4.00	1.14	11.21	36.89	72.93	112.96
4.10	1.30	11.55	37.51	73.65	113.60
4.20	1.37	11.90	38.13	74.35	114.25
4.30	1.45	12.26	38.74	75.03	114.88
4.40	1.54	12.63	39.36	75.76	115.53
4.50	1.62	13.00	39.99	76.47	116.18
4.60	1.69	13.38	40.62	77.15	116.80
4.70	1.78	13.76	41.23	77.86	117.44
4.80	1.90	14.14	41.86	78.56	118.06
4.90	1.98	14.53	42.50	79.26	118.67
5.00	2.07	14.94	43.13	79.96	119.30

Typical Performance Data

IDS (mA)	GAIN (dB) ⁽¹⁾				OIP3 (dBm) ⁽¹⁾			
	VDS=+3V		VDS=+4V		VDS=+3V		VDS=+4V	
	0.9 GHz	2 GHz	0.9 GHz	2 GHz	0.9 GHz	2 GHz	0.9 GHz	2 GHz
10.00	20.02	15.36	20.05	15.39	20.31	21.12	20.16	20.91
15.00	21.22	16.22	21.17	16.18	22.82	24.10	22.70	23.93
30.00	22.62	17.15	22.67	17.14	28.66	30.74	28.32	30.23
60.00	23.53	17.74	23.51	17.73	32.60	33.81	33.41	35.32

IDS (mA)	Pout @ 1dB Compression ^(1,2) (dBm)				NOISE FIGURE ⁽¹⁾ (dB)			
	VDS=+3V		VDS=+4V		VDS=+3V		VDS=+4V	
	0.9 GHz	2 GHz	0.9 GHz	2 GHz	0.9 GHz	2 GHz	0.9 GHz	2 GHz
10.00	17.56	18.18	20.03	20.90	0.48	0.63	--	--
15.00	17.05	17.50	19.29	20.00	0.48	0.54	0.47	0.54
30.00	18.50	19.00	19.50	20.59	0.39	0.50	0.39	0.47
60.00	18.85	19.20	21.12	21.50	0.34	0.43	0.38	0.51

FREQ (GHz)	NF vs FREQ & TEMPERATURE ⁽¹⁾ @ VDS=3V, IDS=30mA			NF vs FREQ & TEMPERATURE ⁽¹⁾ @ VDS=4V, IDS=30mA		
	-40°C	+25°C	+85°C	-40°C	+25°C	+85°C
0.25	0.26	0.35	0.49	0.25	0.33	0.55
0.30	0.23	0.38	0.46	0.24	0.35	0.55
0.40	0.39	0.35	0.42	0.41	0.26	0.48
0.50	0.39	0.33	0.41	0.40	0.35	0.61
0.60	0.32	0.38	0.5	0.35	0.34	0.61
0.70	0.29	0.37	0.49	0.29	0.37	0.62
0.80	0.24	0.36	0.48	0.28	0.33	0.56
0.90	0.33	0.39	0.53	0.30	0.39	0.60
1.00	0.31	0.37	0.51	0.35	0.39	0.56
1.25	0.33	0.43	0.58	0.34	0.44	0.67
1.50	0.34	0.46	0.63	0.32	0.49	0.72
1.75	0.40	0.50	0.72	0.41	0.48	0.72
2.00	0.28	0.50	0.67	0.29	0.47	0.73
2.25	0.32	0.50	0.76	0.31	0.49	0.79
2.50	0.29	0.60	0.79	0.30	0.56	0.82
2.75	0.55	0.74	0.97	0.51	0.76	1.17
3.00	0.36	0.62	0.87	0.40	0.60	0.95
3.25	0.41	0.65	0.91	0.49	0.76	1.07
3.50	0.52	0.68	0.97	0.40	0.88	1.16
3.75	0.36	0.77	1.07	0.53	0.88	1.23
4.00	0.54	0.85	1.13	0.55	0.98	1.32
4.25	0.55	0.91	1.25	0.56	1.05	1.47
4.50	0.62	1.00	1.34	0.54	1.18	1.65
4.75	0.72	1.06	1.36	0.72	1.22	1.72
5.00	0.94	1.29	1.62	0.98	1.40	1.92
5.25	0.54	1.35	1.76	0.69	1.53	2.02
5.50	0.40	1.47	1.93	0.81	1.76	2.26
5.75	1.01	1.51	1.95	1.07	1.85	2.34
6.00	0.76	1.62	2.17	1.02	1.91	2.52

(1) Includes test board loss

(2) Drain current was allowed to increase during compression measurement

Typical Performance Data

FREQ (GHz)	GAIN vs FREQ & TEMPERATURE @ VDS=3V, IDS=30mA			OIP3 vs FREQ & TEMPERATURE ⁽¹⁾ @ VDS=3V, IDS=30mA			P1dB vs FREQ & TEMPERATURE ^(1,2) @ VDS=3V, IDS=30mA		
	-45°C	+25°C	+85°C	-45°C	+25°C	+85°C	-45°C	+25°C	+85°C
0.40	26.16	25.79	25.28	26.37	26.83	25.92	17.24	17.75	17.19
0.50	25.56	25.23	24.63	26.67	27.08	26.24	17.30	17.82	17.27
0.60	24.99	24.57	24.10	26.97	27.33	26.56	17.36	17.88	17.35
0.70	24.36	23.93	23.37	27.26	27.58	26.87	17.42	17.95	17.43
0.80	23.73	23.21	22.75	27.55	27.83	27.18	17.48	18.01	17.51
0.90	23.04	22.62	22.15	27.84	28.08	27.49	17.53	18.06	17.58
1.00	22.47	22.09	21.58	28.13	28.33	27.79	17.59	18.12	17.65
1.10	21.88	21.47	21.02	28.41	28.58	28.09	17.64	18.17	17.72
1.20	21.25	20.91	20.45	28.69	28.82	28.39	17.69	18.22	17.79
1.30	20.73	20.31	19.91	28.96	29.07	28.68	17.73	18.27	17.85
1.40	20.20	19.81	19.37	29.24	29.31	28.97	17.78	18.32	17.91
1.50	19.70	19.34	18.93	29.50	29.56	29.25	17.82	18.36	17.97
1.60	19.21	18.81	18.45	29.77	29.80	29.53	17.86	18.40	18.02
1.70	18.76	18.35	17.99	30.03	30.04	29.81	17.90	18.44	18.07
1.80	18.34	17.98	17.57	30.29	30.29	30.08	17.94	18.48	18.12
1.90	17.93	17.52	17.16	30.55	30.53	30.35	17.97	18.51	18.17
2.00	17.50	17.15	16.75	30.81	30.77	30.62	18.00	18.55	18.21
2.10	17.09	16.77	16.34	31.06	31.01	30.88	18.03	18.58	18.25
2.20	16.73	16.43	16.00	31.30	31.24	31.14	18.06	18.61	18.29
2.30	16.41	16.08	15.65	31.55	31.48	31.40	18.09	18.63	18.33
2.40	16.07	15.76	15.30	31.79	31.72	31.65	18.11	18.65	18.36
2.50	15.79	15.41	15.03	32.03	31.96	31.90	18.14	18.68	18.39
2.60	15.44	15.19	14.66	32.26	32.19	32.14	18.16	18.69	18.42
2.70	15.15	14.88	14.36	32.50	32.43	32.38	18.17	18.71	18.44
2.80	14.87	14.54	14.07	32.72	32.66	32.62	18.19	18.73	18.46
2.90	14.72	14.30	13.88	32.95	32.89	32.85	18.20	18.74	18.48
3.00	14.40	14.05	13.55	33.17	33.13	33.08	18.22	18.75	18.50
3.10	14.19	13.79	13.34	33.39	33.36	33.30	18.23	18.76	18.52
3.20	13.97	13.59	13.08	33.61	33.59	33.53	18.23	18.76	18.53
3.30	13.70	13.32	12.79	33.82	33.82	33.74	18.24	18.76	18.54
3.40	13.43	13.08	12.51	34.03	34.05	33.96	18.24	18.77	18.54
3.50	13.23	12.87	12.29	34.24	34.28	34.17	18.24	18.76	18.54
3.60	13.04	12.62	12.11	34.45	34.51	34.38	18.24	18.76	18.54
3.70	12.75	12.30	11.79	34.65	34.74	34.58	18.24	18.75	18.54
3.80	12.51	12.07	11.53	34.85	34.96	34.78	18.24	18.75	18.54
3.90	12.27	11.87	11.31	35.04	35.19	34.98	18.23	18.74	18.53
4.00	12.04	11.72	11.09	35.23	35.41	35.17	18.22	18.72	18.52
4.10	11.90	11.33	10.93	35.42	35.64	35.36	18.21	18.71	18.51
4.20	11.69	11.16	10.75	35.61	35.86	35.54	18.20	18.69	18.49
4.30	11.50	10.97	10.54	35.79	36.08	35.72	18.18	18.67	18.47
4.40	11.25	10.73	10.31	35.97	36.31	35.90	18.17	18.65	18.45
4.50	11.04	10.46	10.14	36.15	36.53	36.08	18.15	18.62	18.43
4.60	10.67	10.24	9.76	36.32	36.75	36.25	18.13	18.60	18.40
4.70	10.53	10.00	9.60	36.49	36.97	36.41	18.10	18.57	18.37
4.80	10.30	9.80	9.43	36.66	37.19	36.58	18.08	18.54	18.34
4.90	10.06	9.68	9.20	36.82	37.41	36.73	18.05	18.51	18.31
5.00	9.82	9.48	8.93	36.99	37.62	36.89	18.02	18.47	18.27
5.10	9.57	9.28	8.73	37.14	37.84	37.04	17.99	18.43	18.23
5.20	9.34	9.01	8.53	37.30	38.06	37.19	17.96	18.39	18.19
5.30	9.16	8.78	8.38	37.45	38.27	37.33	17.92	18.35	18.14
5.40	8.90	8.62	8.19	37.60	38.49	37.48	17.89	18.31	18.09
5.50	8.75	8.42	8.04	37.74	38.70	37.61	17.85	18.26	18.04
5.60	8.57	8.16	7.75	37.89	38.91	37.75	17.80	18.21	17.99
5.70	8.40	7.93	7.68	38.03	39.13	37.88	17.76	18.16	17.93
5.80	8.25	7.77	7.52	38.16	39.34	38.00	17.72	18.10	17.87
5.90	7.89	7.51	7.17	38.30	39.55	38.13	17.67	18.05	17.81
6.00	7.61	7.35	6.83	38.43	39.76	38.24	17.62	17.99	17.75

(1) Includes test board loss

(2) Drain current was allowed to increase during compression measurement

Typical Performance Data

FREQ (GHz)	GAIN vs FREQ & TEMPERATURE @ VDS=4V, IDS=30mA			OIP3 vs FREQ & TEMPERATURE ⁽¹⁾ @ VDS=4V, IDS=30mA			P1dB vs FREQ & TEMPERATURE ^(1,2) @ VDS=4V, IDS=30mA		
	-45°C	+25°C	+85°C	-45°C	+25°C	+85°C	-45°C	+25°C	+85°C
0.40	26.15	25.84	25.18	26.30	26.55	26.35	18.50	19.00	19.18
0.50	25.64	25.21	24.60	26.57	26.81	26.62	18.62	19.11	19.26
0.60	24.95	24.54	24.06	26.83	27.06	26.88	18.74	19.23	19.34
0.70	24.30	23.88	23.44	27.09	27.30	27.13	18.86	19.34	19.42
0.80	23.67	23.27	22.79	27.34	27.55	27.39	18.98	19.44	19.50
0.90	23.14	22.67	22.21	27.59	27.79	27.63	19.09	19.54	19.57
1.00	22.47	22.01	21.61	27.84	28.03	27.88	19.20	19.64	19.64
1.10	21.87	21.48	21.06	28.08	28.26	28.12	19.30	19.74	19.71
1.20	21.32	20.89	20.50	28.32	28.49	28.36	19.40	19.83	19.77
1.30	20.77	20.36	19.92	28.55	28.72	28.60	19.50	19.92	19.84
1.40	20.20	19.79	19.42	28.78	28.94	28.83	19.59	20.00	19.90
1.50	19.75	19.31	18.97	29.00	29.16	29.06	19.68	20.09	19.95
1.60	19.23	18.86	18.50	29.22	29.38	29.29	19.77	20.16	20.01
1.70	18.78	18.39	18.02	29.43	29.60	29.51	19.85	20.24	20.06
1.80	18.37	17.99	17.64	29.64	29.81	29.73	19.93	20.31	20.12
1.90	17.94	17.55	17.22	29.85	30.02	29.95	20.00	20.37	20.16
2.00	17.50	17.14	16.77	30.05	30.22	30.16	20.07	20.44	20.21
2.10	17.14	16.78	16.40	30.25	30.43	30.37	20.14	20.50	20.25
2.20	16.78	16.42	16.07	30.44	30.63	30.58	20.21	20.55	20.30
2.30	16.44	16.07	15.70	30.63	30.82	30.78	20.27	20.61	20.34
2.40	16.11	15.73	15.33	30.81	31.02	30.98	20.32	20.66	20.37
2.50	15.83	15.45	15.08	30.99	31.21	31.18	20.38	20.70	20.41
2.60	15.49	15.10	14.71	31.17	31.39	31.37	20.43	20.74	20.44
2.70	15.21	14.81	14.39	31.34	31.58	31.56	20.47	20.78	20.47
2.80	14.90	14.53	14.13	31.50	31.76	31.75	20.52	20.82	20.50
2.90	14.77	14.35	13.94	31.66	31.93	31.93	20.56	20.85	20.52
3.00	14.46	14.03	13.58	31.82	32.11	32.11	20.59	20.88	20.54
3.10	14.24	13.81	13.38	31.97	32.28	32.29	20.62	20.90	20.57
3.20	14.01	13.56	13.13	32.12	32.45	32.46	20.65	20.92	20.58
3.30	13.72	13.30	12.82	32.26	32.61	32.63	20.68	20.94	20.60
3.40	13.49	13.04	12.54	32.40	32.77	32.80	20.70	20.95	20.61
3.50	13.27	12.80	12.36	32.54	32.93	32.96	20.71	20.96	20.62
3.60	13.06	12.61	12.14	32.67	33.09	33.12	20.73	20.97	20.63
3.70	12.80	12.35	11.85	32.80	33.24	33.28	20.74	20.97	20.64
3.80	12.58	12.09	11.59	32.92	33.39	33.43	20.74	20.97	20.64
3.90	12.32	11.86	11.38	33.03	33.53	33.58	20.75	20.97	20.64
4.00	12.11	11.62	11.12	33.15	33.67	33.73	20.75	20.96	20.64
4.10	11.96	11.48	10.99	33.25	33.81	33.87	20.74	20.95	20.64
4.20	11.79	11.32	10.84	33.36	33.95	34.01	20.74	20.93	20.63
4.30	11.56	11.08	10.57	33.46	34.08	34.15	20.72	20.92	20.63
4.40	11.31	10.85	10.37	33.55	34.21	34.28	20.71	20.89	20.61
4.50	11.10	10.64	10.20	33.64	34.34	34.42	20.69	20.87	20.60
4.60	10.76	10.30	9.83	33.73	34.46	34.54	20.67	20.84	20.59
4.70	10.58	10.13	9.66	33.81	34.58	34.67	20.64	20.81	20.57
4.80	10.34	9.95	9.52	33.89	34.70	34.79	20.61	20.77	20.55
4.90	10.14	9.71	9.29	33.96	34.81	34.90	20.58	20.73	20.53
5.00	9.87	9.45	9.02	34.03	34.93	35.02	20.54	20.69	20.50
5.10	9.65	9.20	8.82	34.10	35.03	35.13	20.50	20.64	20.48
5.20	9.42	9.01	8.62	34.15	35.14	35.24	20.46	20.59	20.45
5.30	9.24	8.86	8.45	34.21	35.24	35.34	20.41	20.54	20.41
5.40	8.98	8.68	8.31	34.26	35.34	35.44	20.36	20.48	20.38
5.50	8.84	8.45	8.12	34.31	35.43	35.54	20.31	20.42	20.34
5.60	8.61	8.16	7.81	34.35	35.52	35.63	20.25	20.35	20.30
5.70	8.49	8.09	7.72	34.39	35.61	35.72	20.19	20.29	20.26
5.80	8.28	7.92	7.60	34.42	35.70	35.81	20.12	20.21	20.22
5.90	7.94	7.56	7.25	34.45	35.78	35.90	20.05	20.14	20.17
6.00	7.65	7.33	6.94	34.47	35.86	35.98	19.98	20.06	20.13

(1) Includes test board loss

(2) Drain current was allowed to increase during compression measurement

Typical Performance Data

IDS (mA)	F _{MIN} (dB) (1)					
	VDS=+2V		VDS=+3V		VDS=+4V	
	0.9 GHz	2 GHz	0.9 GHz	2 GHz	0.9 GHz	2 GHz
10.00	0.155	0.348	0.154	0.345		
15.00	0.153	0.347	0.135	0.306	0.134	0.302
20.00	0.166	0.370	0.134	0.303		
30.00	0.179	0.395	0.138	0.309	0.129	0.291
40.00	0.177	0.390	0.131	0.296	0.135	0.306
60.00	0.170	0.378	0.141	0.320	0.156	0.349

FREQUENCY (GHz)	F _{MIN} (dB) (1)		
	VDS=3V		
	20 mA	30 mA	40 mA
0.50	0.07	0.08	0.07
0.70	0.10	0.11	0.10
0.90	0.13	0.14	0.13
1.00	0.15	0.15	0.15
1.90	0.29	0.29	0.28
2.00	0.30	0.31	0.30
2.40	0.36	0.37	0.36
3.00	0.46	0.47	0.45
3.90	0.59	0.60	0.58
5.00	0.76	0.78	0.75
5.80	0.88	0.90	0.87
6.00	0.91	0.93	0.90

(1) F_{MIN} is minimum Noise Figure

Typical Performance Curves

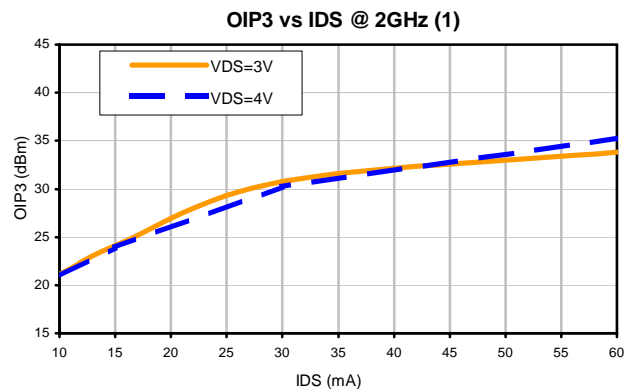
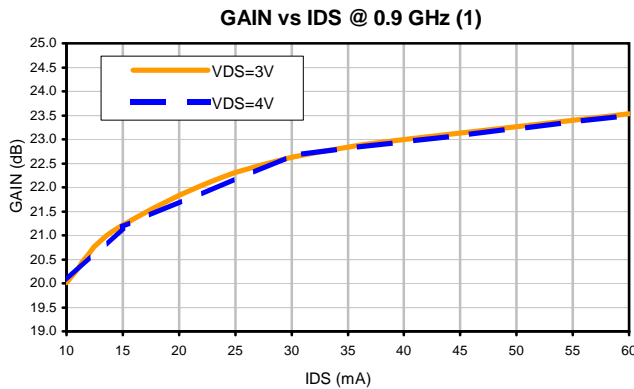
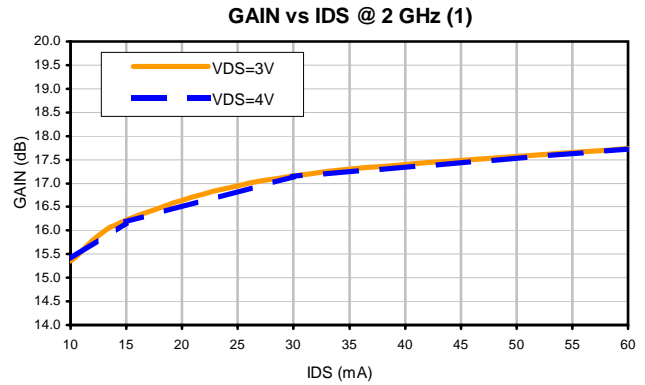
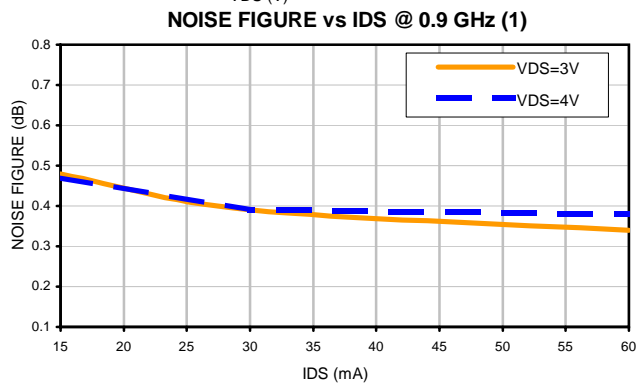
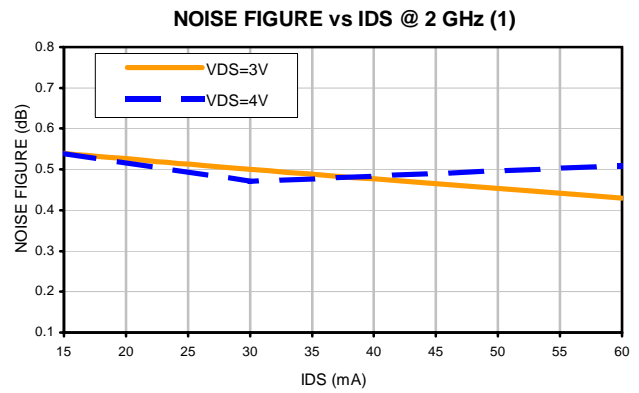
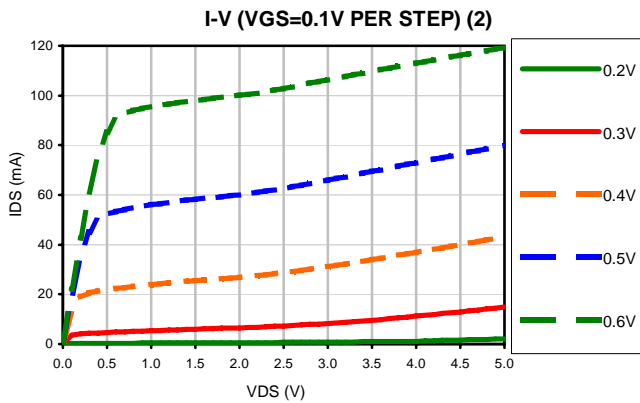

- (1) Includes test board loss
- (2) Measured using HP4155B semiconductor parameter analyzer

Typical Performance Curves

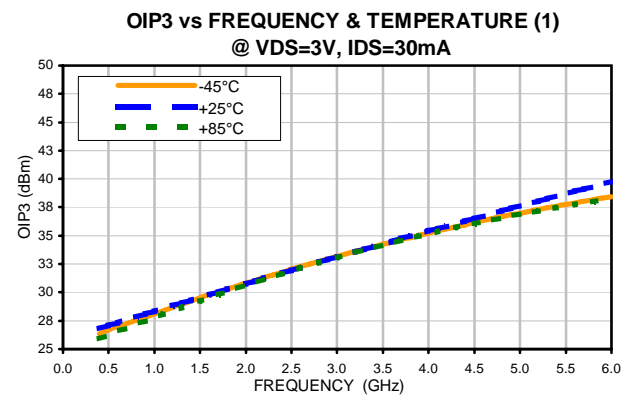
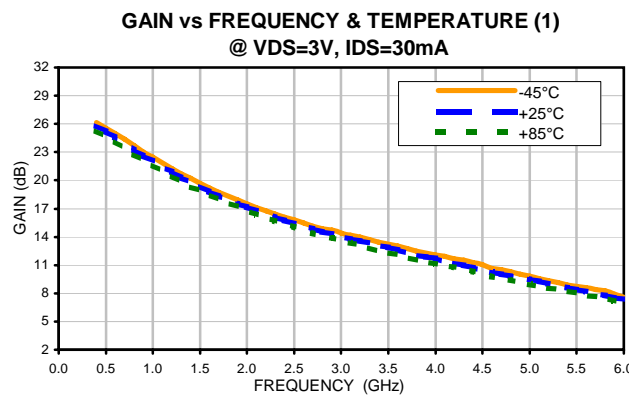
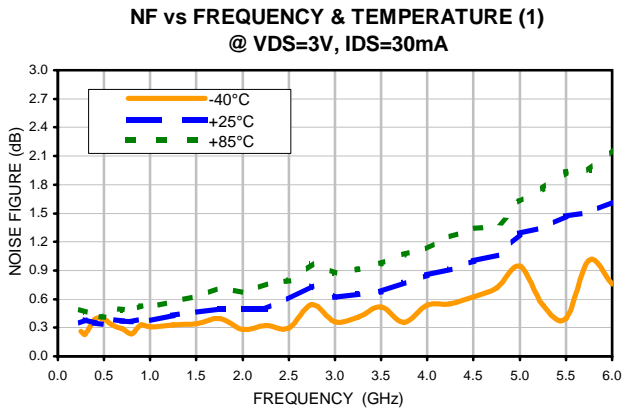
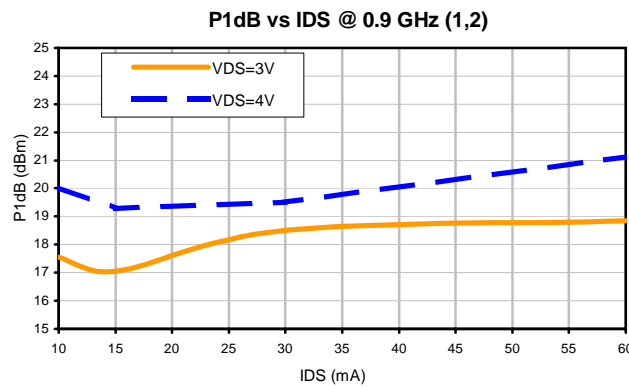
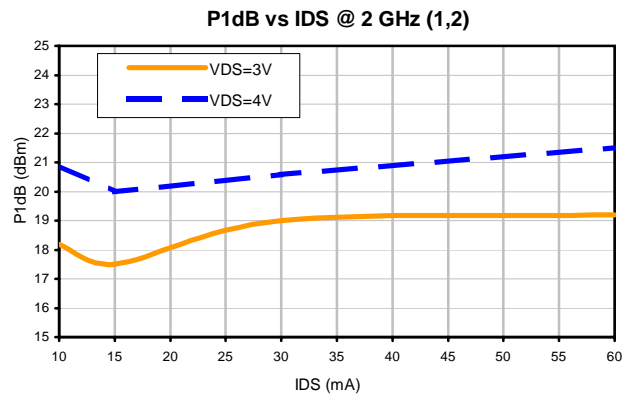
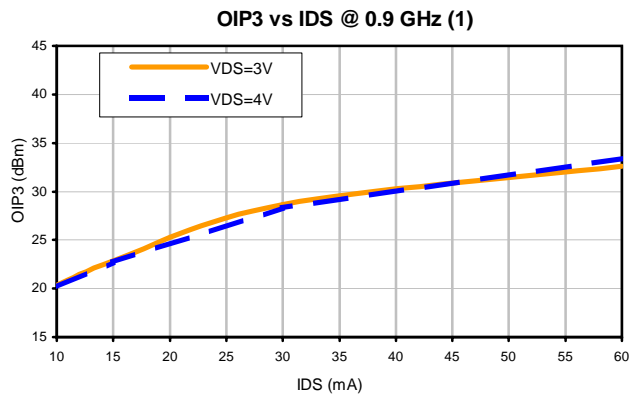

- (1) Includes test board loss
- (2) Drain current was allowed to increase during compression measurement

Typical Performance Curves

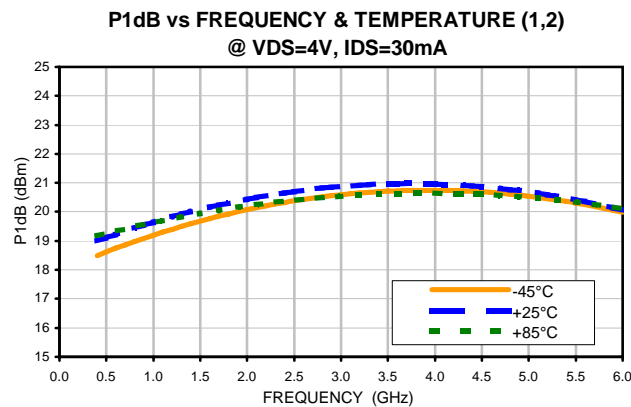
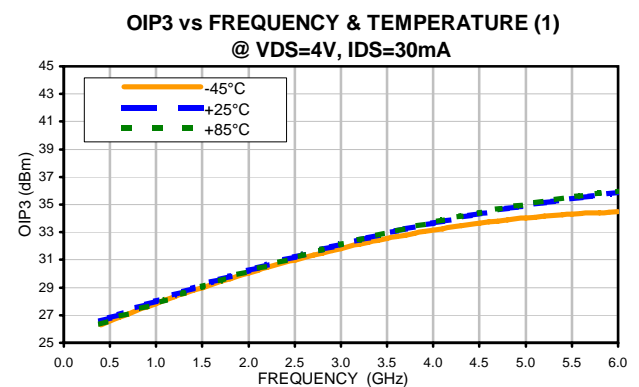
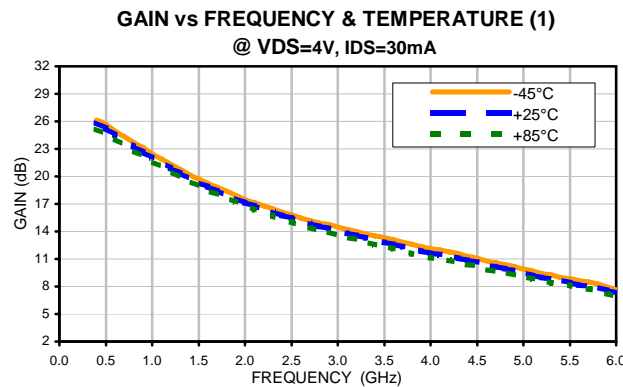
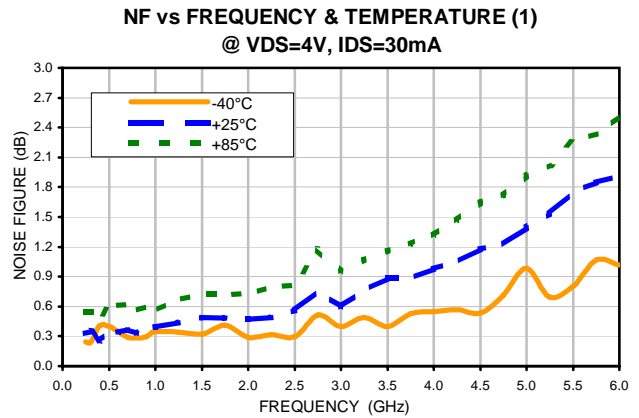
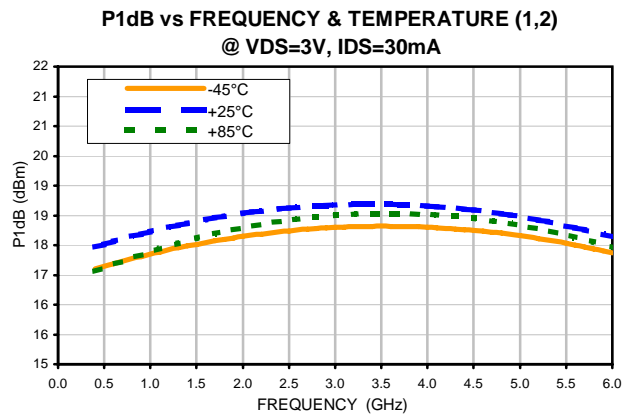

- (1) Includes test board loss
- (2) Drain current was allowed to increase during compression measurement

Typical Performance Curves

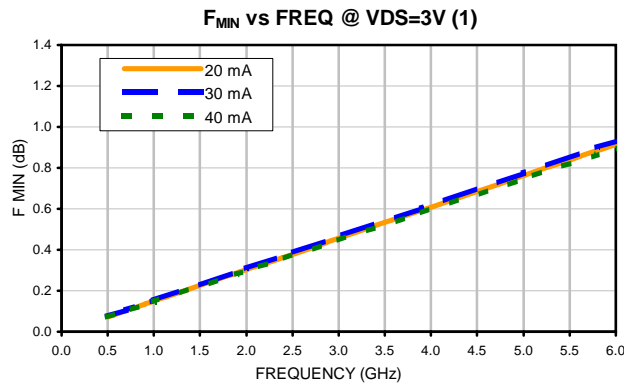
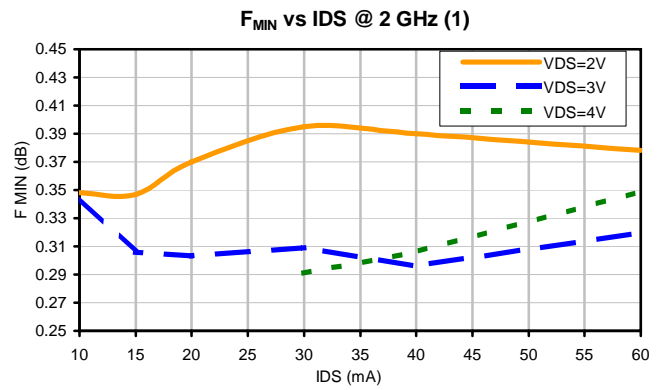
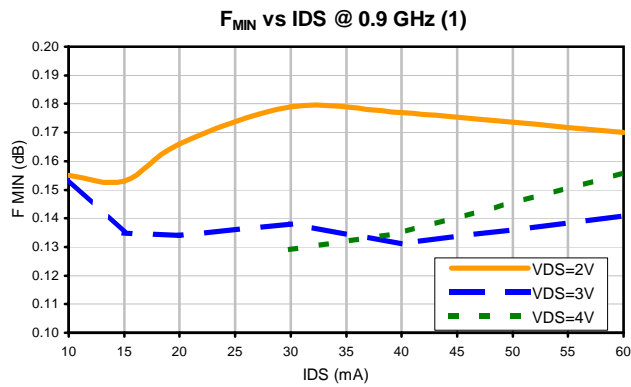

(1) F_{MIN} is minimum Noise Figure

Outline Dimensions

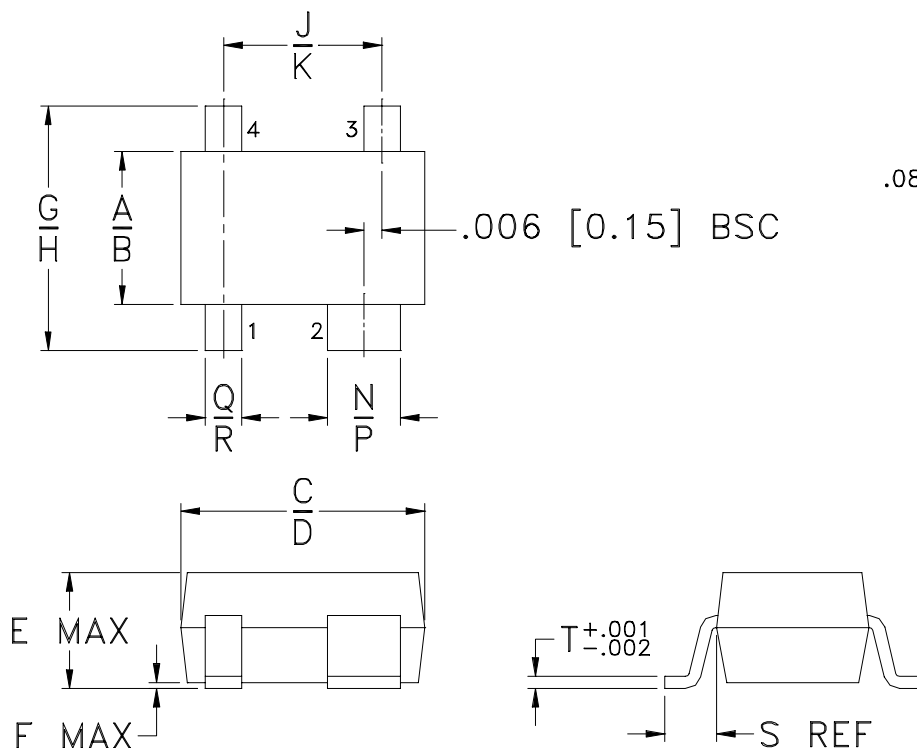

PCB Land Pattern

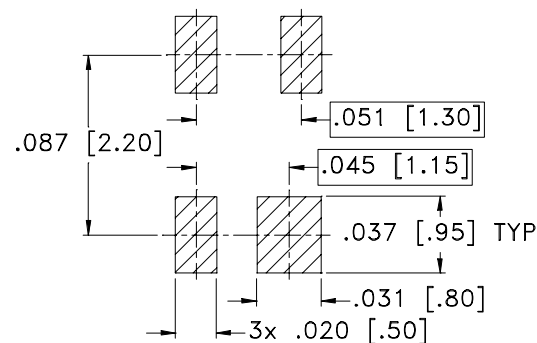

Suggested Layout,
Tolerance to be within $\pm .002$

CASE #.	A	B	C	D	E	F	G	H	J	K	L	M	N	P
MMM1362	.045 (1.15)	.053 (1.35)	.073 (1.85)	.089 (2.25)	.043 (1.10)	.004 (0.10)	.071 (1.80)	.094 (2.40)	.046 (1.17)	.056 (1.43)	-	-	.022 (0.55)	.028 (0.70)

CASE #.	Q	R	S	T	WT, GRAM
MMM1362	.010 (0.25)	.016 (0.40)	.017 (0.43)	.006 (0.15)	.007

Dimensions are in inches (mm). Tolerances: 2 Pl. $\pm .01$; 3 Pl. $\pm .005$

Notes:

- Case material: Plastic.
- Termination finish:
For RoHS Case Styles: Matte Tin plate.

Tape & Reel Packaging TR-F90

DEVICE ORIENTATION IN T&R

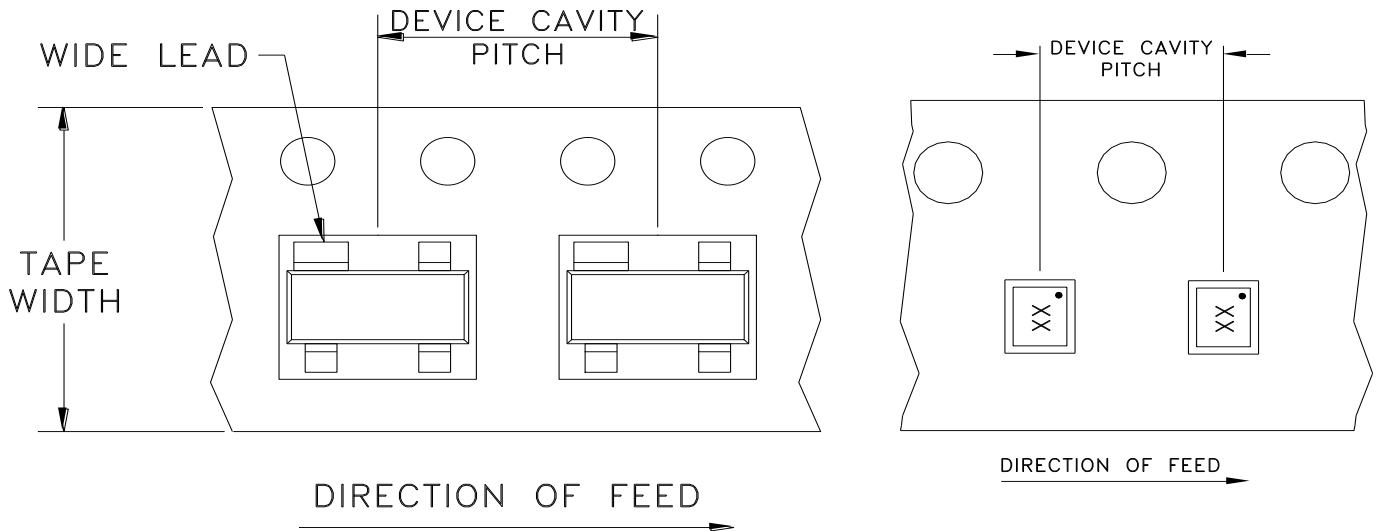

Applicable Case Style
MMM1362

NONE

Tape Width, mm	Device Cavity Pitch, mm	Reel Size, inches	Devices per Reel	
8	4	7	Small quantity standards (see note)	20
				50
				100
				200
				500
				1000
		7	Standards	2000
				3000

Note: Please Consult individual model data sheet to determine device per reel availability.

| [Applicable Case Styles](#) |

Mini-Circuits carrier tape materials provide protection from ESD (Electro-Static Discharge) during handling and transportation. Tapes are static dissipative and comply with industry standards EIA-481/EIA-541.

Go to: www.minicircuits.com/pages/pdfs/tape.pdf

| [MZ4532C](#) |

 **Mini-Circuits**[®]

INTERNET <http://www.minicircuits.com>

P.O. Box 350166, Brooklyn, New York 11235-0003 (718) 934-4500 Fax (718) 332-4661

Distribution Centers NORTH AMERICA 800-654-7949 • 417-335-5935 • Fax 417-335-5945 • EUROPE 44-1252-832600 • Fax 44-1252-837010

Mini-Circuits ISO 9001 & ISO 14001 Certified

THIRD ANGLE PROJECTION

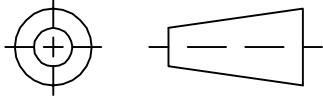

REVISIONS

REV	ECN No.	DESCRIPTION	DATE	DR	AUTH
OR	M121884	NEW RELEASE	03/10/09	AV	TH

SUGGESTED MOUNTING CONFIGURATION FOR
MMM1362 CASE STYLE, "04AM02" PIN CODE

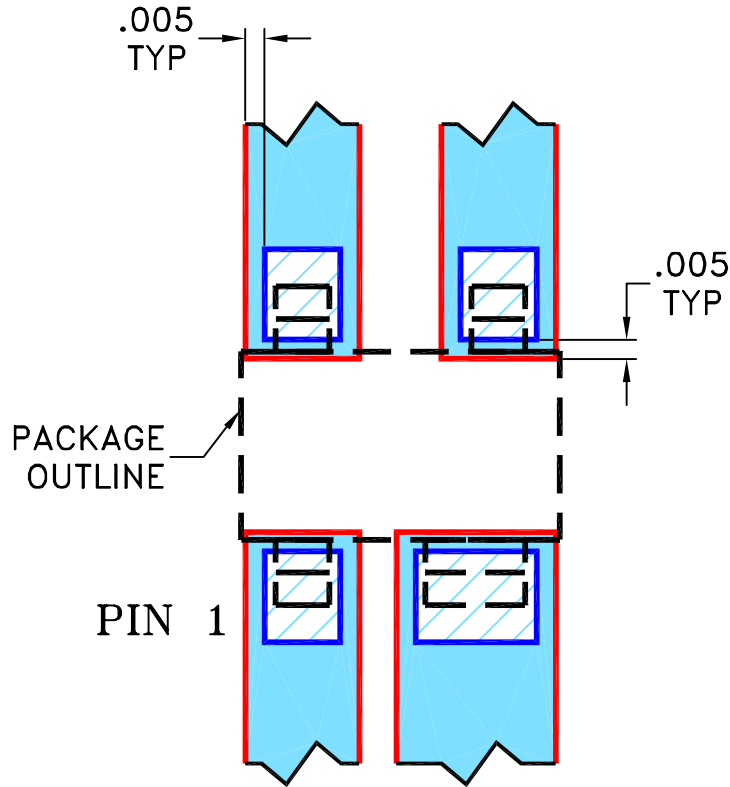

NOTES:

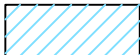
1. TRACE WIDTH IS SHOWN FOR REFERENCE ONLY. ACTUAL LINE WIDTH IS A FUNCTION OF SPECIFIC MATCHING CIRCUIT.
2. BOTTOM SIDE OF THE PCB IS CONTINUOUS GROUND PLANE.
3.  DENOTES PCB COPPER LAYOUT WITH SMOBC (SOLDER MASK OVER BARE COPPER);
 DENOTES COPPER LAND PATTERN FREE OF SOLDER MASK.

UNLESS OTHERWISE SPECIFIED

DIMENSIONS ARE IN INCHES
TOLERANCES ON:
2 PL DECIMALS ±
3 PL DECIMALS ± .005
ANGLES ±
FRACTIONS ±

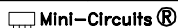

THIS DOCUMENT AND ITS CONTENTS ARE THE PROPERTY OF MINI-CIRCUITS. EXCEPT FOR USE EXPRESSLY GRANTED, IN WRITING, TO ITS VENDORS, VENDEE AND THE UNITED STATES GOVERNMENT, MINI-CIRCUITS RESERVES ALL PROPRIETARY DESIGN, USE, MANUFACTURING AND REPRODUCTION RIGHTS THERETO. THESE CONTENTS SHALL NOT BE USED, DUPLICATED OR DISCLOSED TO ANY OUTSIDE PARTY, IN WHOLE OR IN PART, WITHOUT WRITTEN PERMISSION OF MINI-CIRCUITS.

ASHEETA1.DWG REV:A DATE:01/12/95



Mini-Circuits®

13 Neptune Avenue
Brooklyn NY 11235

PL, 04AM02, FG873, SAV

SIZE A	CODE IDENT 15542	DRAWING NO: 98-PL-300	REV: OR
-----------	---------------------	--------------------------	------------

FILE: 98PL300	SCALE: 20:1	SHEET: 1 OF 1
------------------	----------------	------------------

Characterization Test Board

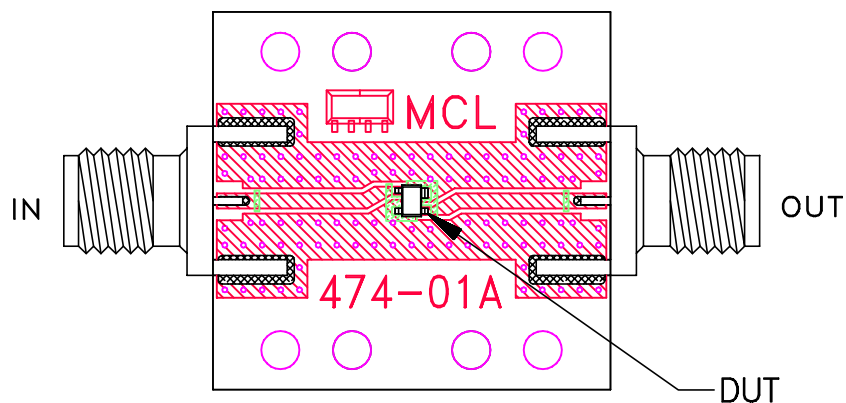

TB-471+

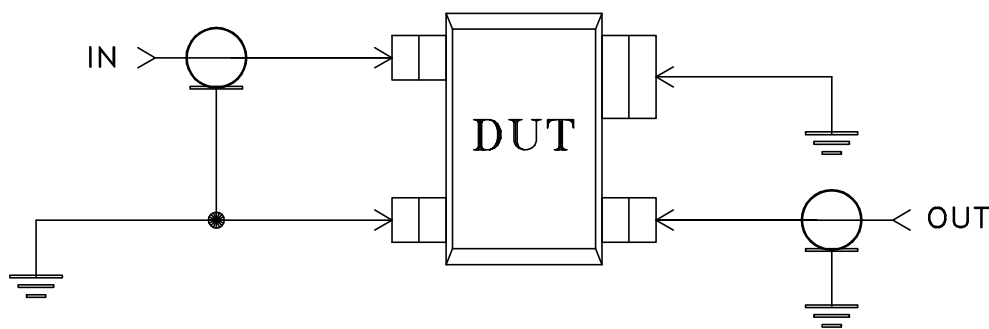

Schematic Diagram

Notes:

1. 50 Ohm SMA Female connectors.
2. PCB Material: Rogers R04350B or its equivalent, Dielectric Constant=3.5, Thickness=.020"

 **Mini-Circuits®**



All Mini-Circuits products are manufactured under exacting quality assurance and control standards, and are capable of meeting published specifications after being subjected to any or all of the following physical and environmental test.

Specification	Test/Inspection Condition	Reference/Spec
Operating Temperature	-45° to 85°C Ambient Environment	Individual Model Data Sheet
Storage Temperature	-65° to 150° C Ambient Environment	Individual Model Data Sheet
Thermal Shock	-65° to 150°C, 500 Cycles	MIL-STD-883E, Method 1010.7
Autoclave	15 psig, 100% RH, 121°C, 96 hours	JESD22-A102-C, Condition C
Solderability	10X Magnification	J-STD-002, Para 4.2.5, Test S, 95% Coverage
Solder Reflow Heat	Pb-Free Process: 260°C peak	J-STD-020C, Table 4-1, 4-2 and 5-2; Figure 5-1
Moisture Sensitivity: Level 1	Bake at 125°C for 24 hours Soak at 85°C/85% RH for 168 hours, Reflow 3 cycles at 260°C peak	J-STD-020C
Marking Resistance to Solvents	Solution A, C and D followed by 3 reflow cycles at 260°C peak	MIL-STD-202F, Method 215J
Lead Integrity	Tension - Cond. A Bonding Stress - Cond. B1	MIL-STD-883E, Method 2004.5