



USB / RS232

# Programmable Attenuator

# RUDAT-6000-60

50Ω 1 to 6000 MHz, 0 - 60 dB, 0.25 dB step

## THE BIG DEAL

- Wide attenuation range, 60 dB
- Fine attenuation resolution, 0.25 dB
- Short attenuation transition time (650 ns)
- Compact size, 3.0 x 2.0 x 0.6"
- USB and RS232 control



Generic photo used for illustration purposes only.

## APPLICATIONS

- LTE, 5G FR1, DVB fading simulators
- Wi-Fi device testing
- Signal level calibration
- Automated gain control
- Laboratory instrumentation

Model No.	RUDAT-6000-60
Case Style	MS1813
Connectors	SMA (female)

DOWNLOAD

SOFTWARE PACKAGE

**RoHS Compliant**

See our web site for RoHS Compliance methodologies and qualifications

## PRODUCT OVERVIEW

Mini-Circuits' RUDAT-6000-60 is a general purpose, single channel programmable attenuator suitable for a wide range of signal level control applications from 1 to 6000 MHz. The attenuator provides 0 to 60 dB attenuation in 0.25 dB steps. Its unique design maintains linear attenuation change per dB, even at the highest attenuation settings.

The attenuator is housed in a compact and rugged package with SMA female connectors on the bi-directional input and output RF ports, a standard 9 pin D-Sub port (RJ45) and a USB type Mini-B power and control port. The attenuator can be controlled via USB or RS232 (via D-Sub connector).

Full software support is provided, including our user-friendly GUI application for Windows and a full API with programming instructions for Windows and Linux environments (both 32-bit and 64-bit systems).

## KEY FEATURES

Feature	Advantages
Programmable attenuation sweep and hop sequences	The module can be programmed with a timed sequence of attenuation settings, to run without any additional external control.
60 dB attenuation range	The module provides high-accuracy attenuation up to 60 dB in 0.25 dB steps, allowing the user precise level control over a broad attenuation and frequency range.
High linearity	Typical input IP3 of +51 dBm up to 6000 MHz.
USB and RS232 control	USB HID and RS232 (for serial communication) interfaces provide easy compatibility with a wide range of software setups and programming environments.
Full software support	User friendly Windows GUI (graphical user interface) allows manual control straight out of the box, while the comprehensive API (application programming interface) with examples and instructions allows easy automation in most programming environments

### Trademarks:

Windows is a registered trademark of Microsoft Corporation in the United States and other countries ; Linux is a registered trademark of Linus Torvalds ; Pentium is a registered trademark of Intel Corporation. Neither Mini-Circuits nor the Mini-Circuits products are affiliated with or endorsed by the owners of the referenced trademarks. Mini-Circuits and the Mini-Circuits logo are registered trademarks of Scientific Components Corporation.



ELECTRICAL SPECIFICATIONS<sup>1</sup> AT 0 TO 50°C

Parameter	Conditions	Frequency (MHz)	Min.	Typ.	Max.	Unit
Attenuation range	0.25 dB step	1 - 6000	0	-	60	dB
Attenuation accuracy <sup>2</sup>	0.25 - 20 dB	1 - 2000	-	±0.25	±(0.45 + 4.5% of Atten.)	dB
		2000 - 4000	-	±0.35	±(0.45 + 4.5% of Atten.)	
		4000 - 6000	-	±0.25	±(0.50 + 4.5% of Atten.)	
	20.25 - 60 dB	1 - 2000	-	±0.85	±(0.75 + 2.0% of Atten.)	
2000 - 4000		-	±0.70	±(0.85 + 1.5% of Atten.)		
		4000 - 6000	-	±0.55	±(0.70 + 2.5% of Atten.)	
Insertion loss	0 dB	1 - 2000	-	3.0	5.0	dB
		2000 - 4000	-	4.7	6.5	
		4000 - 6000	-	6.2	7.5	
Isolation in-out <sup>3</sup>	-	1 - 6000	-	67	-	dB
Return loss in	0 - 40 dB	1 - 500	-	20	-	dB
		500 - 4000	-	23	-	
		4000 - 6000	-	16	-	
	40.25 - 60 dB	1 - 500	-	25	-	
500 - 4000		-	23	-		
		4000 - 6000	-	14	-	
Return loss out	0 - 20 dB	1 - 4000	-	19	-	dB
		4000 - 6000	-	16	-	
	20.25 - 60 dB	1 - 4000	-	15	-	
		4000 - 6000	-	14	-	
IP3 input <sup>4</sup>	0 dB setting (P <sub>IN</sub> = +5 dBm)	1 - 3000	-	+53	-	dBm
		3000 - 6000	-	+51	-	
Input operating power <sup>5</sup>	0 - 60 dB	1 - 50	-	-	Note 6	dBm
		50 - 6000	-	-	+23	
Attenuation transition time <sup>7</sup>	-	1 - 6000	-	650	-	ns
Minimum dwell time <sup>8</sup>	High-speed mode	1 - 6000	-	600	-	µs
Supply voltage (Vcc)	USB port / D-Sub pin#1 <sup>9</sup>	-	4.75	5	5.25	V <sub>DC</sub>
Supply current (Icc)		-	-	190	250	mA

1. Attenuator RF ports support simultaneous, bi-directional signal transmission, within the specified power limits. However the specifications are guaranteed for the RF in and RF out as noted on the label. There may be minor changes in performance when injecting signals to the RF Out port.

2. Max accuracy defined as  $\pm[\text{absolute error} + \% \text{ of attenuation setting}]$ . For example, if a 100 dB attenuation at 5000 MHz is defined as max accuracy of " $\pm(-1.1 + 4\%)$ " then the maximum error at those settings will be:  $\pm(-1.1 + 0.04 \times 100) = \pm(-1.1 + 4) = \pm 2.9$  dB.

3. Isolation is defined as max attenuation plus insertion loss; this is the path loss through the attenuator when initially powered up. After a brief delay (~0.5 sec typically) the attenuator will revert to a user defined "power-up" state (either max attenuation or a pre-set value).

4. Tested with 1 MHz span between signals.

5. Total operating input power per channel from both RF In and RF Out out ports. Compression level not noted as it exceeds max safe operating power level.

6. Derate linearly from +23 dBm at 50 MHz to +9 dBm at 1 MHz.

7. Attenuation transition time is specified as the time between starting to change the attenuation state and settling on the requested attenuation state.

8. Minimum dwell time is the time the module will take to respond to a command to change attenuation states without communication delays. In PC control add communication delays (on the order of msec for USB) to get actual response time.

9. Supply voltage +5V at Pin#1 of D-sub connector applies to units with S/N 11407150001 and greater.



### COMMUNICATION PARAMETERS

Type	Protocol	Communication speed
USB <sup>10</sup>	HID (Human Interface Device) - High-speed	400 $\mu$ s Typ (full transmit/receive cycle)
RS232	Meets RS232 standard at all voltages, 8-bit word, no parity, stop bit = '1'	9600 bps

10. USB min communication time is based on the polling interval of the USB HID protocol (125  $\mu$ s polling interval, 1024 bytes per packet), medium CPU load and no other high speed USB devices using the USB bus.

### ABSOLUTE MAXIMUM RATINGS

Operating temperature	0°C to 50°C	
Storage temperature	-20°C to 85°C	
DC voltage at RF ports	16 V	
V <sub>USB</sub> MAX	6 V	
Total RF power for RF in & RF out	1 - 50 MHz	Derates linearly from +26 dBm @ 50 MHz to +12 dBm @ 1 MHz
	50 - 6000 MHz	+26 dBm

Permanent damage may occur if any of these limits are exceeded. Operating in the range between operating power limits and absolute maximum ratings for extended periods of time may result in reduced life and reliability.

### PROGRAMMABLE ATTENUATOR RESPONSE TO COMMUNICATION INTERRUPT

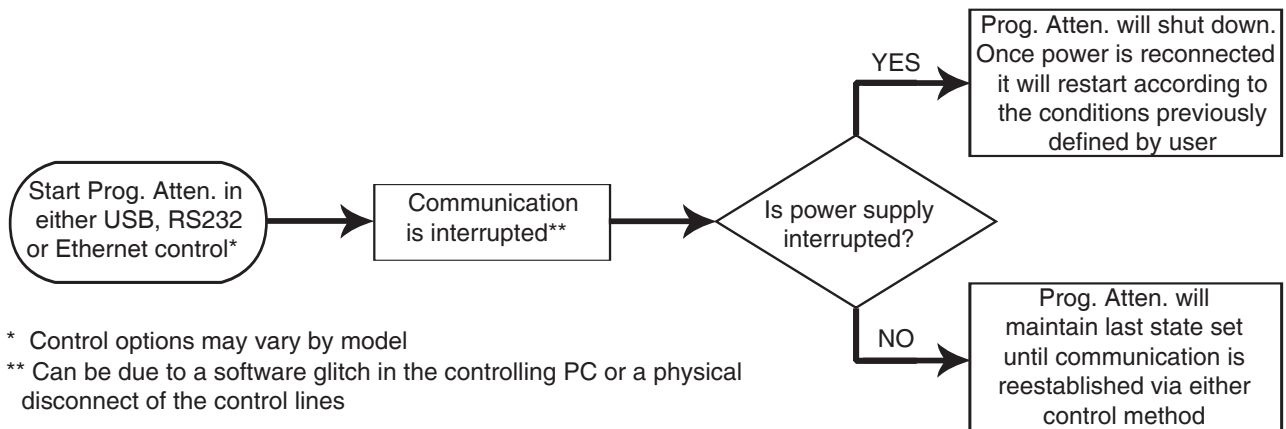



### 9 PIN D-SUB PIN CONNECTIONS <sup>11</sup>

Pin Number	Function
2	Transmit
3	Receive
5	GND
1	+5 V <sub>DC</sub> <sup>12,13</sup>
4,6-9	Not Connected

11. Pin #1 can be used as supply voltage (+) pin instead of USB connection on units with S/N 11407150001 and greater. When using RS232 control on units with S/N lower than 11407150001 pin #1 is defined "Not Connected" and power must be provided via included power adaptor or a USB bus instead.
12. When USB power is connected, pin #1 may be connected to GND or supply voltage (+) or remain disconnected.
13. Power on sequence for RS232 control: Connect 5V power followed by the control lines.

### CONNECTIONS

Port Name	Connector Type
RF in	SMA female
RF out	SMA female
USB	USB type Mini-B female
RS232	9 pin D-Sub female

### BLOCK DIAGRAM

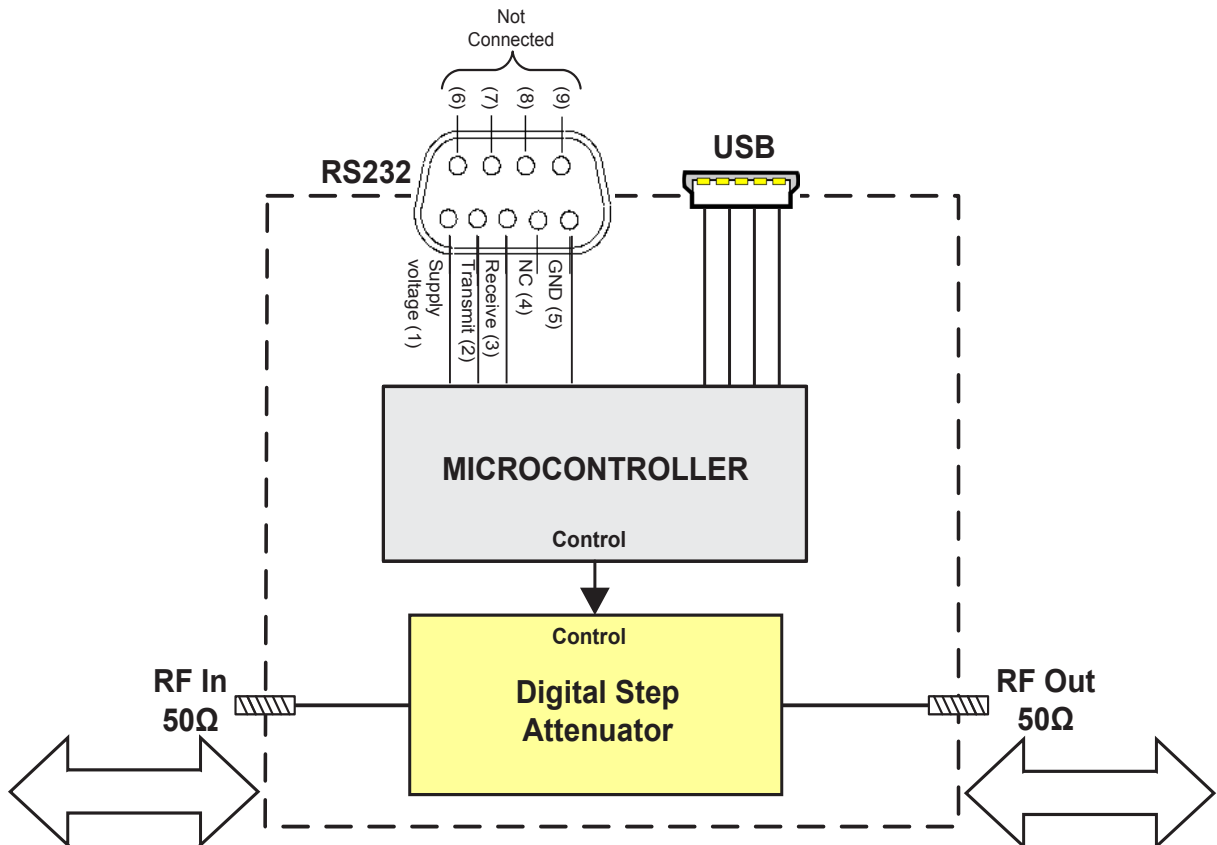



USB / RS232

# Programmable Attenuator

**RUDAT-6000-60**

**OUTLINE DRAWING (MS1813)**

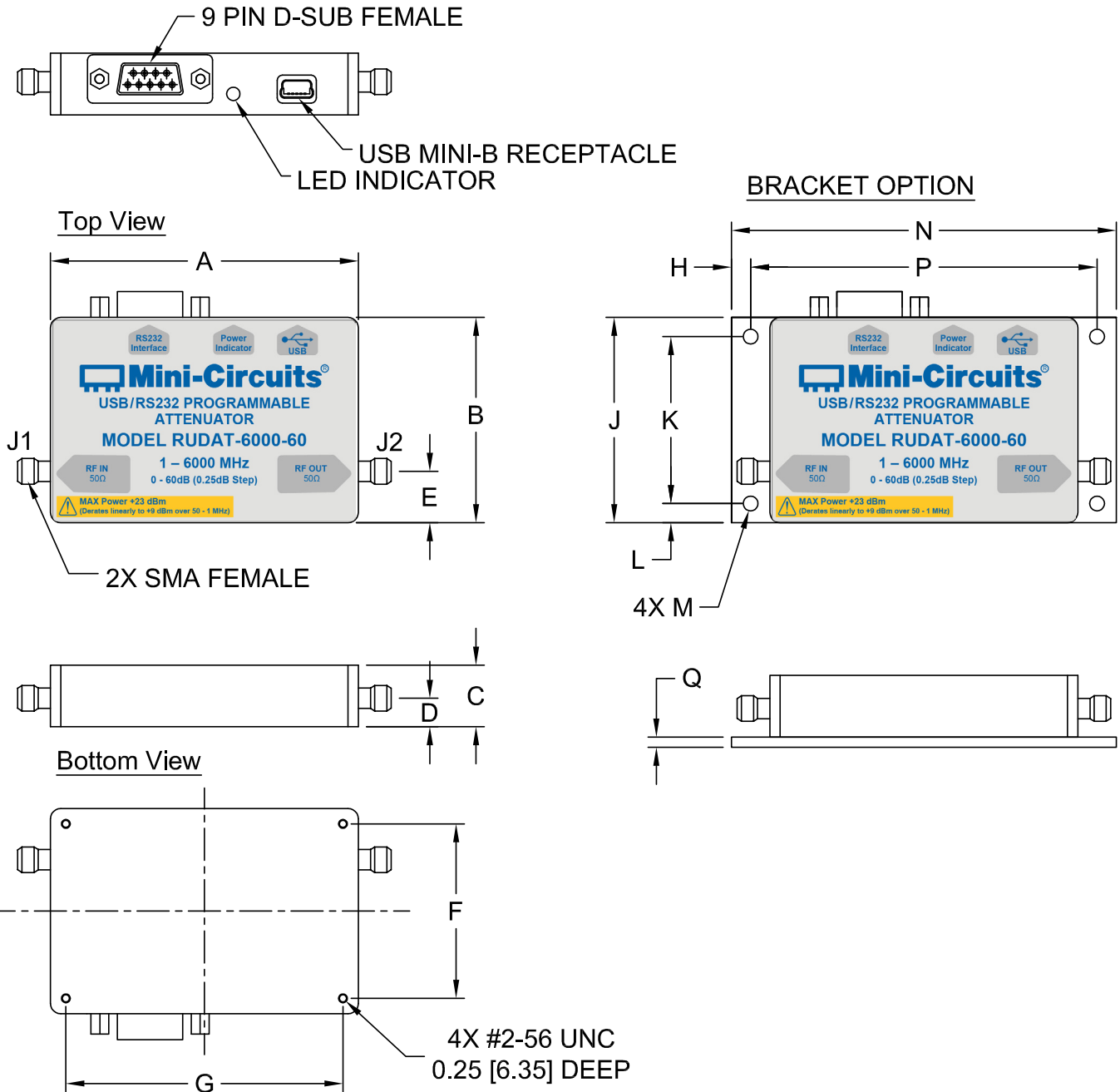

**OUTLINE DIMENSIONS ( INCH / MM )**

A	B	C	D	E	F	G	H	J	K	L	M	N	P	Q	weight
3.00	2.00	0.60	0.28	0.50	1.70	2.70	0.188	2.00	1.625	0.188	0.144	3.75	3.375	0.10	grams
76.20	50.80	15.24	7.10	12.70	43.18	68.58	4.760	50.80	41.280	4.760	3.660	95.30	85.720	2.54	130





### TYPICAL PERFORMANCE DATA

Freq. [MHz]	I.Loss [dB]	Attenuation relative to I. Loss (at 25°C)									
		[dB]									
		@ Attenuation setting [dB]									
		0.25	5	10	20	30	35	40	50	55	60
1	-1.90	-0.27	-4.91	-9.87	-19.79	-29.68	-34.75	-39.59	-49.37	-54.16	-59.20
100	-2.00	-0.26	-4.90	-9.85	-19.78	-29.66	-34.74	-39.57	-49.37	-54.12	-59.16
375	-2.27	-0.26	-4.83	-9.70	-19.73	-29.58	-34.66	-39.48	-49.27	-54.02	-59.05
625	-2.55	-0.25	-4.76	-9.54	-19.69	-29.51	-34.58	-39.39	-49.17	-53.92	-58.95
875	-2.77	-0.25	-4.74	-9.48	-19.69	-29.49	-34.56	-39.35	-49.12	-53.87	-58.88
1125	-2.92	-0.25	-4.77	-9.55	-19.72	-29.53	-34.59	-39.36	-49.12	-53.87	-58.88
1375	-3.06	-0.25	-4.83	-9.67	-19.76	-29.58	-34.64	-39.41	-49.15	-53.90	-58.92
1625	-3.24	-0.25	-4.85	-9.72	-19.75	-29.58	-34.66	-39.43	-49.18	-53.93	-58.94
1875	-3.48	-0.26	-4.83	-9.67	-19.71	-29.56	-34.64	-39.44	-49.20	-53.95	-58.97
2125	-3.71	-0.25	-4.78	-9.58	-19.68	-29.53	-34.62	-39.44	-49.22	-53.98	-59.00
2625	-4.08	-0.25	-4.76	-9.53	-19.76	-29.63	-34.74	-39.54	-49.33	-54.11	-59.14
3125	-4.46	-0.26	-4.77	-9.61	-19.84	-29.72	-34.86	-39.59	-49.37	-54.17	-59.26
3375	-4.67	-0.26	-4.77	-9.62	-19.85	-29.75	-34.91	-39.65	-49.45	-54.23	-59.35
3875	-5.08	-0.26	-4.79	-9.72	-19.92	-29.92	-35.12	-40.03	-49.91	-54.68	-59.82
4125	-5.28	-0.26	-4.83	-9.85	-19.96	-30.03	-35.26	-40.28	-50.22	-54.99	-60.09
4375	-5.47	-0.26	-4.90	-10.01	-20.01	-30.14	-35.39	-40.48	-50.47	-55.26	-60.30
4500	-5.55	-0.27	-4.94	-10.09	-20.04	-30.19	-35.44	-40.54	-50.56	-55.35	-60.40
4750	-5.71	-0.28	-5.02	-10.21	-20.12	-30.28	-35.51	-40.60	-50.64	-55.45	-60.46
4875	-5.78	-0.29	-5.05	-10.23	-20.15	-30.30	-35.52	-40.58	-50.62	-55.44	-60.45
5125	-5.92	-0.30	-5.08	-10.23	-20.22	-30.32	-35.51	-40.47	-50.52	-55.35	-60.35
5250	-6.00	-0.31	-5.08	-10.19	-20.26	-30.31	-35.48	-40.40	-50.44	-55.26	-60.25
5500	-6.14	-0.31	-5.06	-10.09	-20.32	-30.28	-35.40	-40.26	-50.28	-55.10	-60.11
5625	-6.21	-0.31	-5.05	-10.04	-20.34	-30.28	-35.38	-40.22	-50.24	-55.05	-60.06
5875	-6.35	-0.31	-5.01	-9.96	-20.38	-30.27	-35.35	-40.24	-50.27	-55.05	-60.07
6000	-6.41	-0.31	-4.99	-9.95	-20.39	-30.29	-35.36	-40.29	-50.34	-55.10	-60.13



### TYPICAL PERFORMANCE DATA (CONTINUED)

Freq. [MHz]	I.Loss [dB]	Attenuation relative to I. Loss (at 0°C)									
		[dB]									
		@ Attenuation setting [dB]									
		0.25	5	10	20	30	35	40	50	55	60
1	-1.81	-0.27	-4.95	-9.93	-19.88	-29.79	-34.87	-39.71	-49.55	-54.31	-59.35
100	-1.91	-0.27	-4.94	-9.90	-19.86	-29.76	-34.85	-39.69	-49.52	-54.28	-59.33
375	-2.16	-0.26	-4.88	-9.78	-19.82	-29.71	-34.79	-39.64	-49.47	-54.22	-59.28
625	-2.43	-0.26	-4.80	-9.62	-19.77	-29.64	-34.72	-39.57	-49.39	-54.14	-59.18
875	-2.64	-0.25	-4.78	-9.56	-19.76	-29.62	-34.70	-39.54	-49.35	-54.11	-59.14
1125	-2.79	-0.25	-4.82	-9.63	-19.80	-29.65	-34.73	-39.54	-49.33	-54.10	-59.12
1375	-2.93	-0.26	-4.87	-9.74	-19.84	-29.70	-34.77	-39.57	-49.35	-54.10	-59.13
1625	-3.11	-0.26	-4.89	-9.78	-19.84	-29.70	-34.78	-39.57	-49.34	-54.11	-59.15
1875	-3.34	-0.26	-4.87	-9.73	-19.80	-29.67	-34.76	-39.57	-49.35	-54.13	-59.15
2125	-3.56	-0.26	-4.82	-9.64	-19.76	-29.64	-34.74	-39.59	-49.39	-54.16	-59.19
2625	-3.90	-0.26	-4.79	-9.60	-19.83	-29.74	-34.87	-39.71	-49.54	-54.34	-59.36
3125	-4.25	-0.26	-4.80	-9.66	-19.91	-29.83	-34.97	-39.73	-49.55	-54.37	-59.42
3375	-4.45	-0.26	-4.80	-9.66	-19.93	-29.85	-35.01	-39.77	-49.60	-54.40	-59.53
3875	-4.84	-0.26	-4.81	-9.77	-20.00	-30.01	-35.21	-40.15	-50.05	-54.83	-59.96
4125	-5.05	-0.26	-4.86	-9.92	-20.05	-30.14	-35.37	-40.43	-50.40	-55.17	-60.27
4375	-5.25	-0.27	-4.94	-10.10	-20.11	-30.28	-35.52	-40.67	-50.70	-55.48	-60.55
4500	-5.34	-0.27	-4.99	-10.18	-20.14	-30.34	-35.58	-40.74	-50.79	-55.61	-60.61
4750	-5.52	-0.29	-5.07	-10.30	-20.22	-30.43	-35.66	-40.80	-50.87	-55.69	-60.68
4875	-5.61	-0.29	-5.09	-10.32	-20.25	-30.45	-35.66	-40.77	-50.86	-55.69	-60.64
5125	-5.77	-0.30	-5.12	-10.30	-20.31	-30.45	-35.63	-40.63	-50.70	-55.54	-60.47
5250	-5.86	-0.31	-5.12	-10.26	-20.34	-30.43	-35.58	-40.52	-50.58	-55.43	-60.37
5500	-6.01	-0.31	-5.09	-10.13	-20.37	-30.36	-35.46	-40.32	-50.37	-55.20	-60.13
5625	-6.09	-0.31	-5.06	-10.07	-20.39	-30.34	-35.41	-40.27	-50.30	-55.12	-60.08
5875	-6.23	-0.31	-5.01	-9.98	-20.40	-30.31	-35.35	-40.26	-50.31	-55.10	-60.05
6000	-6.28	-0.31	-5.00	-9.98	-20.41	-30.32	-35.36	-40.31	-50.39	-55.17	-60.10

Freq. [MHz]	I.Loss [dB]	Attenuation relative to I. Loss (at 50°C)									
		[dB]									
		@ Attenuation setting [dB]									
		0.25	5	10	20	30	35	40	50	55	60
1	-1.98	-0.26	-4.87	-9.81	-19.72	-29.58	-34.66	-39.47	-49.27	-53.97	-59.02
100	-2.08	-0.26	-4.87	-9.80	-19.73	-29.58	-34.65	-39.47	-49.24	-53.98	-59.01
375	-2.36	-0.26	-4.79	-9.64	-19.67	-29.48	-34.55	-39.35	-49.11	-53.85	-58.87
625	-2.65	-0.25	-4.72	-9.48	-19.63	-29.41	-34.46	-39.24	-48.99	-53.71	-58.74
875	-2.88	-0.25	-4.70	-9.43	-19.63	-29.39	-34.44	-39.19	-48.92	-53.66	-58.67
1125	-3.02	-0.25	-4.74	-9.49	-19.66	-29.42	-34.48	-39.21	-48.92	-53.66	-58.67
1375	-3.16	-0.25	-4.80	-9.61	-19.69	-29.47	-34.53	-39.27	-48.98	-53.72	-58.73
1625	-3.35	-0.25	-4.82	-9.67	-19.68	-29.49	-34.56	-39.31	-49.03	-53.77	-58.78
1875	-3.58	-0.25	-4.80	-9.63	-19.64	-29.47	-34.54	-39.33	-49.06	-53.81	-58.81
2125	-3.83	-0.25	-4.76	-9.54	-19.62	-29.44	-34.53	-39.33	-49.07	-53.82	-58.83
2625	-4.22	-0.25	-4.73	-9.48	-19.71	-29.54	-34.65	-39.40	-49.15	-53.92	-58.95
3125	-4.62	-0.26	-4.75	-9.57	-19.79	-29.64	-34.78	-39.48	-49.22	-54.00	-59.09
3375	-4.84	-0.26	-4.75	-9.59	-19.80	-29.68	-34.84	-39.56	-49.33	-54.10	-59.22
3875	-5.26	-0.26	-4.77	-9.69	-19.86	-29.84	-35.05	-39.94	-49.79	-54.55	-59.69
4125	-5.44	-0.26	-4.81	-9.80	-19.90	-29.94	-35.18	-40.16	-50.07	-54.84	-59.95
4375	-5.62	-0.26	-4.87	-9.95	-19.94	-30.05	-35.29	-40.33	-50.30	-55.08	-60.16
4500	-5.70	-0.27	-4.91	-10.02	-19.97	-30.09	-35.34	-40.39	-50.38	-55.15	-60.22
4750	-5.85	-0.28	-4.99	-10.14	-20.04	-30.17	-35.41	-40.44	-50.45	-55.24	-60.28
4875	-5.91	-0.29	-5.01	-10.17	-20.08	-30.19	-35.42	-40.43	-50.46	-55.24	-60.29
5125	-6.03	-0.30	-5.05	-10.17	-20.16	-30.23	-35.42	-40.36	-50.38	-55.18	-60.23
5250	-6.11	-0.31	-5.06	-10.15	-20.21	-30.23	-35.41	-40.31	-50.32	-55.11	-60.19
5500	-6.25	-0.31	-5.05	-10.06	-20.28	-30.23	-35.36	-40.21	-50.21	-55.00	-60.05
5625	-6.32	-0.31	-5.04	-10.01	-20.31	-30.22	-35.34	-40.18	-50.19	-54.96	-60.00
5875	-6.46	-0.31	-5.00	-9.94	-20.35	-30.24	-35.33	-40.20	-50.23	-54.99	-60.07
6000	-6.53	-0.31	-4.99	-9.93	-20.37	-30.26	-35.35	-40.25	-50.28	-55.03	-60.10



### TYPICAL PERFORMANCE DATA (CONTINUED)

Freq. [MHz]	Return Loss In (at 25°C)										
	[dB]										
	@ Attenuation setting [dB]										
	0	0.25	5	10	20	30	35	40	50	55	60
1	-14.32	-14.63	-17.45	-22.79	-17.07	-19.51	-20.43	-24.23	-30.60	-32.63	-30.36
100	-14.81	-15.14	-17.97	-23.66	-17.37	-19.87	-20.82	-25.11	-34.82	-42.70	-35.31
375	-17.04	-17.34	-19.95	-25.16	-18.67	-20.54	-21.21	-25.51	-34.49	-38.66	-33.65
625	-22.20	-22.41	-24.05	-28.18	-21.22	-22.04	-22.34	-26.80	-35.20	-36.46	-31.25
875	-32.52	-31.92	-28.92	-31.09	-24.49	-24.11	-24.12	-28.79	-35.75	-34.58	-29.45
1125	-26.57	-26.70	-27.70	-31.47	-26.74	-26.38	-26.37	-31.23	-35.76	-33.24	-28.26
1375	-21.65	-21.93	-24.86	-30.90	-26.31	-27.96	-28.40	-33.44	-35.52	-32.43	-27.57
1625	-19.95	-20.23	-23.56	-30.93	-24.81	-28.01	-29.02	-34.54	-35.15	-31.90	-27.16
1875	-20.12	-20.35	-23.60	-31.82	-23.67	-26.92	-27.96	-34.39	-34.88	-31.57	-26.91
2125	-22.02	-22.16	-24.91	-33.53	-23.14	-25.69	-26.46	-33.52	-34.75	-31.42	-26.81
2625	-35.94	-34.87	-32.67	-36.66	-25.51	-26.15	-26.39	-33.03	-31.49	-29.28	-25.79
3125	-30.71	-31.33	-31.49	-29.84	-39.11	-45.73	-40.33	-31.54	-26.10	-24.88	-22.83
3375	-28.49	-29.31	-29.24	-27.05	-25.25	-27.79	-27.83	-26.83	-23.69	-22.76	-21.12
3875	-18.13	-18.73	-21.94	-22.10	-17.82	-19.38	-19.60	-21.23	-20.01	-19.33	-18.06
4125	-16.23	-16.90	-20.30	-20.63	-17.18	-18.88	-19.17	-20.23	-18.68	-18.02	-16.82
4375	-16.42	-17.27	-20.59	-19.90	-18.24	-20.27	-20.66	-19.90	-17.59	-16.91	-15.74
4500	-17.38	-18.41	-21.57	-19.70	-19.64	-21.89	-22.27	-19.84	-17.09	-16.40	-15.25
4750	-22.10	-24.06	-25.89	-19.51	-26.37	-28.11	-27.38	-19.68	-16.29	-15.59	-14.44
4875	-26.84	-30.26	-28.12	-19.36	-36.53	-29.79	-27.75	-19.41	-15.97	-15.26	-14.11
5125	-28.37	-26.17	-23.58	-18.32	-25.32	-22.48	-21.67	-18.08	-15.18	-14.50	-13.38
5250	-22.57	-21.35	-20.63	-17.67	-20.89	-19.76	-19.35	-17.34	-14.84	-14.18	-13.08
5500	-16.82	-16.29	-16.38	-16.02	-16.14	-16.19	-16.18	-15.71	-14.05	-13.46	-12.41
5625	-15.37	-14.99	-15.15	-15.40	-14.95	-15.29	-15.41	-15.19	-13.81	-13.25	-12.21
5875	-13.27	-13.06	-13.24	-13.89	-13.41	-13.96	-14.25	-13.99	-12.96	-12.48	-11.53
6000	-12.74	-12.57	-12.75	-13.37	-13.14	-13.69	-14.02	-13.62	-12.66	-12.21	-11.27

Freq. [MHz]	Return Loss Out (at 25°C)										
	[dB]										
	@ Attenuation setting [dB]										
	0	0.25	5	10	20	30	35	40	50	55	60
1	-14.30	-14.59	-29.59	-32.59	-18.93	-17.42	-18.05	-18.04	-17.97	-17.61	-17.71
100	-14.76	-15.05	-34.46	-33.97	-19.38	-17.79	-18.47	-18.46	-18.38	-17.99	-18.09
375	-17.09	-17.35	-34.95	-22.96	-19.41	-17.88	-18.55	-18.54	-18.48	-18.08	-18.17
625	-22.60	-22.77	-35.86	-19.97	-19.21	-17.79	-18.45	-18.44	-18.39	-18.00	-18.06
875	-32.93	-31.52	-34.47	-19.00	-18.99	-17.65	-18.29	-18.28	-18.25	-17.85	-17.89
1125	-23.81	-23.61	-31.50	-19.21	-18.87	-17.55	-18.18	-18.17	-18.14	-17.75	-17.76
1375	-18.98	-19.01	-28.22	-20.35	-18.86	-17.51	-18.13	-18.13	-18.09	-17.70	-17.70
1625	-16.99	-17.10	-25.84	-22.70	-18.95	-17.57	-18.20	-18.19	-18.16	-17.75	-17.74
1875	-16.71	-16.87	-25.01	-28.01	-19.15	-17.75	-18.41	-18.40	-18.36	-17.94	-17.92
2125	-18.10	-18.30	-26.09	-38.16	-19.48	-18.08	-18.77	-18.76	-18.72	-18.29	-18.26
2625	-29.79	-29.92	-34.07	-20.81	-20.82	-19.28	-20.09	-20.08	-20.04	-19.53	-19.46
3125	-19.87	-19.70	-26.49	-20.33	-22.54	-20.88	-21.80	-21.79	-21.84	-21.19	-20.94
3375	-18.07	-18.01	-26.96	-24.48	-22.86	-21.39	-22.28	-22.28	-22.43	-21.72	-21.31
3875	-17.22	-17.39	-24.51	-20.81	-21.47	-20.85	-21.44	-21.43	-21.79	-21.17	-20.46
4125	-16.79	-16.98	-21.56	-17.29	-20.25	-19.96	-20.39	-20.38	-20.77	-20.23	-19.49
4375	-16.65	-16.75	-20.35	-16.14	-19.05	-18.93	-19.25	-19.24	-19.62	-19.16	-18.43
4500	-16.81	-16.83	-20.46	-16.29	-18.46	-18.38	-18.67	-18.66	-19.04	-18.60	-17.89
4750	-17.50	-17.33	-21.99	-17.75	-17.47	-17.43	-17.68	-17.67	-18.02	-17.63	-16.94
4875	-17.99	-17.74	-23.54	-19.08	-17.01	-16.97	-17.20	-17.20	-17.53	-17.16	-16.49
5125	-19.40	-19.02	-28.68	-22.51	-16.13	-16.07	-16.30	-16.30	-16.60	-16.25	-15.62
5250	-20.13	-19.71	-29.89	-23.52	-15.74	-15.67	-15.89	-15.89	-16.19	-15.84	-15.23
5500	-20.75	-20.30	-24.15	-21.68	-14.97	-14.89	-15.11	-15.10	-15.37	-15.04	-14.46
5625	-20.14	-19.73	-21.42	-20.26	-14.54	-14.45	-14.67	-14.67	-14.92	-14.59	-14.04
5875	-17.85	-17.56	-18.20	-19.13	-13.97	-13.87	-14.10	-14.10	-14.34	-14.02	-13.49
6000	-16.75	-16.54	-17.16	-19.15	-13.59	-13.48	-13.72	-13.72	-13.94	-13.63	-13.13





## TYPICAL PERFORMANCE CURVES

### Attenuation Accuracy @ 25°C vs. Frequency over Attenuation settings

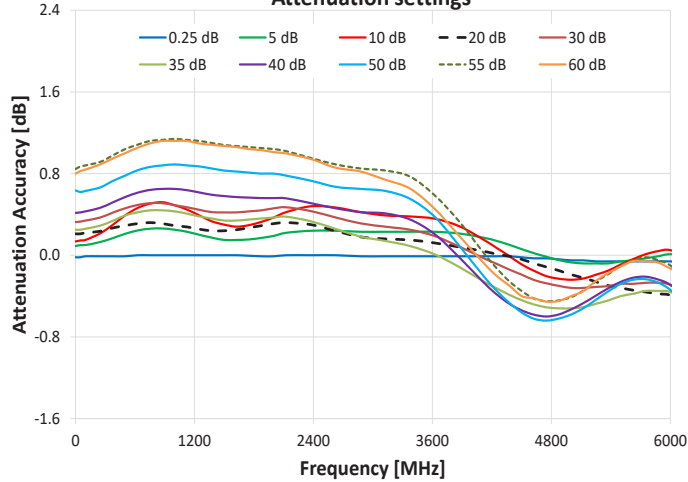

### Attenuation Accuracy @ 0°C vs. Frequency over Attenuation settings

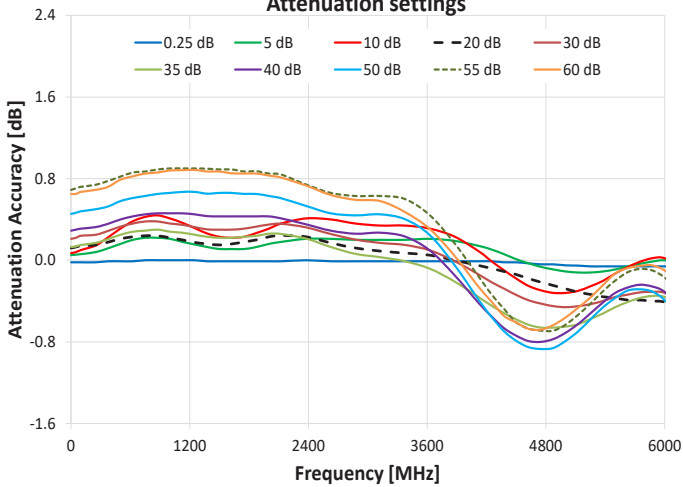

### Attenuation Accuracy @ 50°C vs. Frequency over Attenuation settings

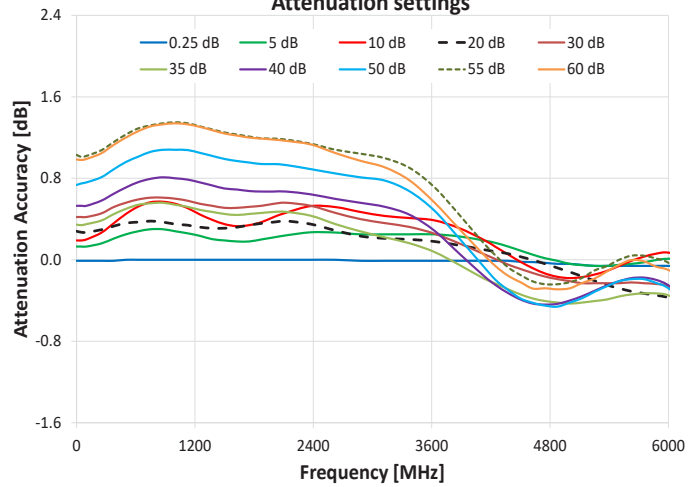

### Attenuation Accuracy @ 1 - 6000 MHz vs. Attenuation settings over Temperature

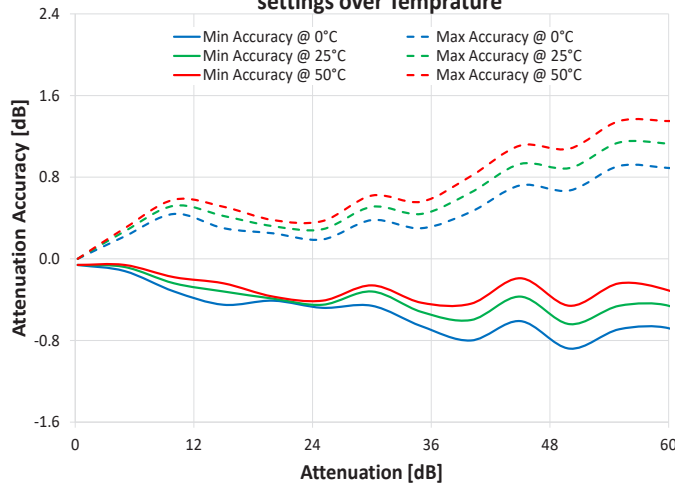



## TYPICAL PERFORMANCE CURVES (CONTINUED)

### Insertion Loss vs. Frequency over Temperature

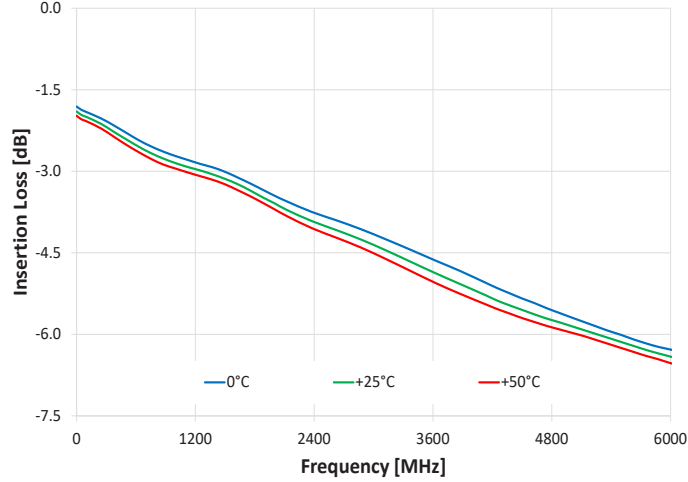

### R. Loss In vs. Frequency over Attenuation settings

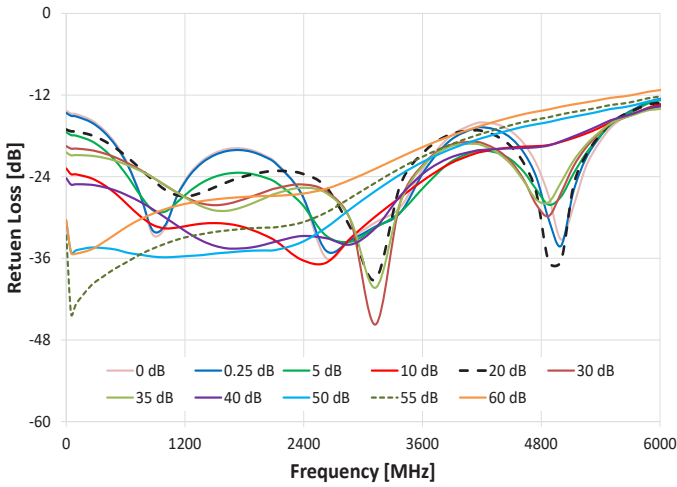

### R. Loss Out vs. Frequency over Attenuation settings

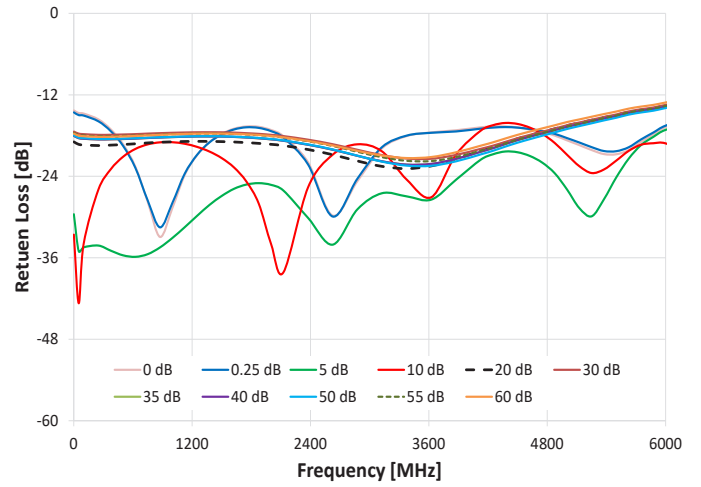

### IP3 @ 0 dB Attenuation

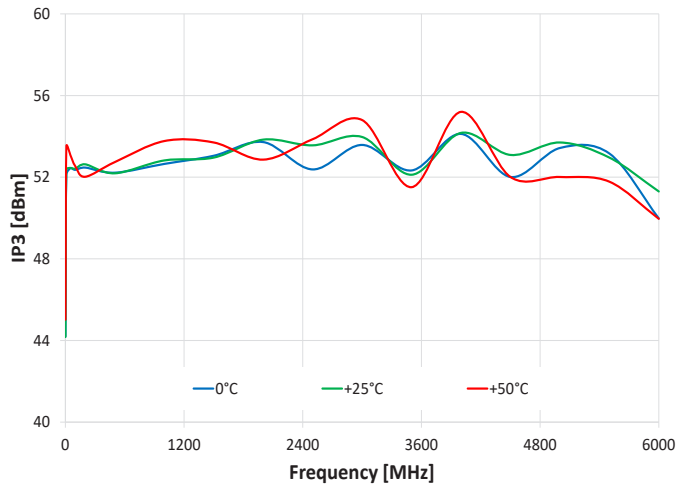



## SOFTWARE SPECIFICATIONS

### SOFTWARE & DOCUMENTATION DOWNLOAD:

- Mini-Circuits' full software and support package including user guide, Windows GUI, DLL files, programming manual and examples can be downloaded free of charge from: <https://www.minicircuits.com/softwaredownload/patt.html>
- Please contact [testsolutions@minicircuits.com](mailto:testsolutions@minicircuits.com) for support

### MINIMUM SYSTEM REQUIREMENTS:

Parameter	Requirements	
Interface	USB HID or RS232	
System Requirements	GUI	Windows 7 or later
	USB API DLL	Windows 7 or later and programming environment with ActiveX or .NET support
	USB Direct Programming	Linux, Windows 7 or later
	RS232	Any computer with a serial port and RS232 support
Hardware	Intel i3 (or equivalent) or later	

### APPLICATION PROGRAMMING INTERFACE (API)

#### USB SUPPORT (WINDOWS):

- ActiveX COM DLL file for creation of 32-bit programs
- .NET library DLL file for creation of 32 / 64-bit programs
- Supported by most common programming environments (refer to application note [AN-49-001](#) for summary of supported environments)

#### USB SUPPORT (LINUX):

- Direct USB programming using a series of USB interrupt codes
- Full programming instructions and examples available for a wide range of programming environments / languages.



### GRAPHICAL USER INTERFACE (GUI) FOR WINDOWS - KEY FEATURES

- Connect via USB to control the module.
- Run GUI in "demo mode" to evaluate software without a hardware connection.

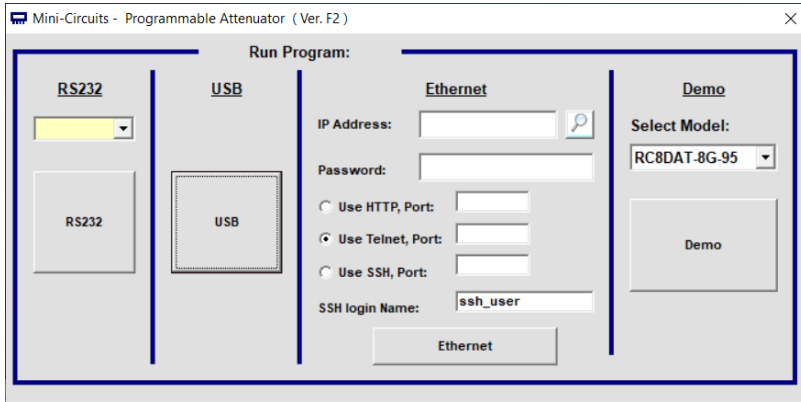

- Manual attenuation setting.
- Sweep and Hop attenuation sequences directed from the PC, or entire sequence loaded into the module.
- Attenuator address configuration and firmware upgrade.
- Attenuation at power up may be set to selected attenuation level or last attenuation state recorded.

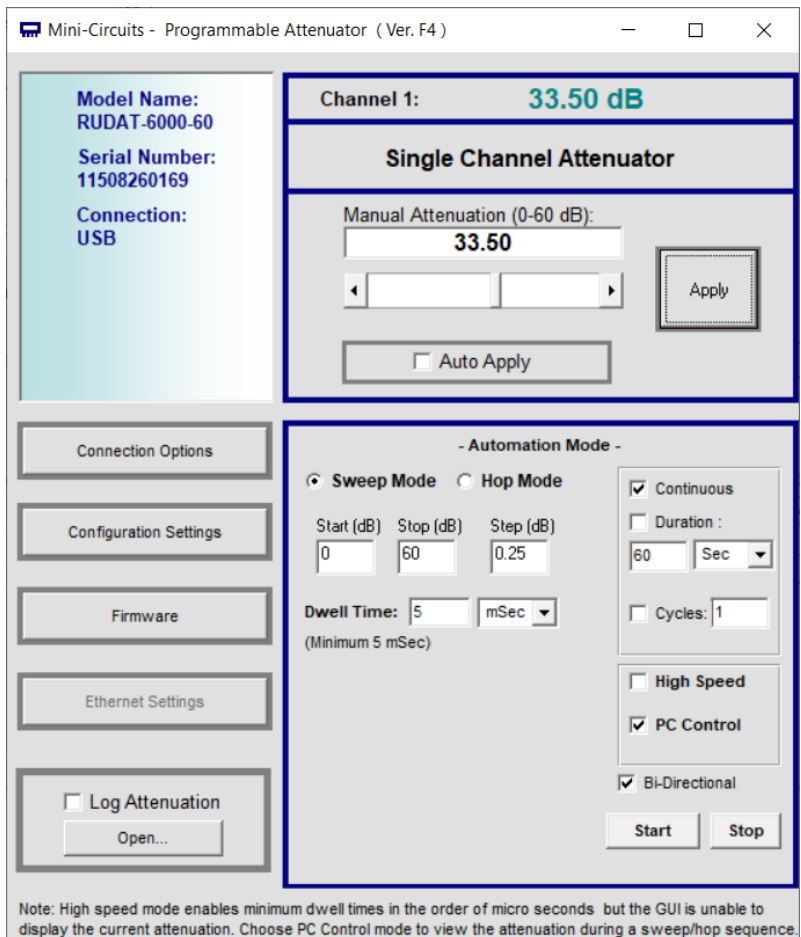

**ORDERING INFORMATION**

Please contact Mini-Circuits' Test Solutions department for price and availability: [testsolutions@minicircuits.com](mailto:testsolutions@minicircuits.com)

Model	Description
RUDAT-6000-60	USB / RS232 Programmable Attenuator

Included Accessories	Part No.	Description
	MUSB-CBL-3+	3.3 ft (1.0 m) USB cable: USB type A (Male) to USB type Mini-B (Male)

**OPTIONAL ACCESSORIES**

USB-CBL-AC-3+	3.3 ft (1.0 m) USB cable: USB type A (Male) to USB type Mini-B (Male)
USB-CBL-AC-7+	6.6 ft (2.0 m) USB cable: USB type A (Male) to USB type Mini-B (Male)
D-SUB9-MF-6+	6.0 ft (1.8 m) RS232 cable: 9 pin D-sub (Male) to 9 pin D-sub (Female)
BKT-3901+	Bracket kit, including: 3.75 x 2.00" bracket, mounting screws and washers
USB-AC/DC-5+	AC/DC +5V <sub>DC</sub> power adaptor with USB connector <sup>14, 15</sup>

14. The USB-AC/DC-5 may be used to provide the 5V<sub>DC</sub> power input via USB port if operating the module with RS232 control. Not required if using USB control.

15. Includes power plugs for US, UK, EU, IL, AU & China. Plugs for other countries are also available. If you need a power cord for a country not listed please contact [testsolutions@minicircuits.com](mailto:testsolutions@minicircuits.com)

**NOTES:**

- Performance and quality attributes and conditions not expressly stated in this specification document are intended to be excluded and do not form a part of this specification document.
- Electrical specifications and performance data contained in this specification document are based on Mini-Circuit's applicable established test performance criteria and measurement instructions.
- The parts covered by this specification document are subject to Mini-Circuits standard limited warranty and terms and conditions (collectively, "Standard Terms"); Purchasers of this part are entitled to the rights and benefits contained therein. For a full statement of the Standard Terms and the exclusive rights and remedies thereunder, please visit Mini-Circuits' website at <https://www.minicircuits.com/terms/viewterm.html>

# Programmable Attenuator RUDAT-6000-60

## Typical Performance Data @ 0°C

FREQUENCY (MHz)	Attenuation relative to Insertion Loss (dB)							
	0.25 dB	10 dB	15 dB	20 dB	30 dB	40 dB	50 dB	60 dB
1	0.25	9.68	14.66	19.19	28.72	38.99	48.74	58.76
5	0.25	9.69	14.67	19.20	28.72	39.00	48.75	58.80
10	0.25	9.69	14.67	19.20	28.73	39.00	48.76	58.77
20	0.25	9.69	14.67	19.20	28.73	39.00	48.74	58.75
50	0.25	9.68	14.66	19.19	28.72	38.99	48.74	58.76
100	0.25	9.68	14.66	19.19	28.71	38.98	48.74	58.76
200	0.25	9.64	14.61	19.15	28.67	38.94	48.70	58.72
500	0.24	9.53	14.46	19.00	28.51	38.77	48.55	58.54
750	0.23	9.44	14.34	18.88	28.39	38.64	48.42	58.40
1000	0.23	9.42	14.31	18.86	28.38	38.61	48.41	58.41
1500	0.23	9.53	14.46	19.03	28.57	38.80	48.63	58.66
2000	0.24	9.66	14.64	19.27	28.84	39.08	48.98	59.10
2500	0.23	9.73	14.73	19.45	29.06	39.29	49.30	59.47
3000	0.23	9.66	14.62	19.43	29.07	39.25	49.37	59.58
3500	0.23	9.80	14.78	19.64	29.33	39.39	49.58	59.81
4000	0.25	10.30	15.41	20.43	30.22	40.28	50.51	60.77
4500	0.26	10.68	15.86	21.19	31.04	41.14	51.50	61.58
5000	0.26	10.67	15.66	21.19	30.98	40.82	51.34	61.17
5500	0.22	10.15	14.99	20.50	30.31	39.57	49.98	59.77
6000	0.24	10.64	15.66	21.45	31.38	40.40	50.61	60.13

FREQUENCY (MHz)	Attenuation accuracy relative to nominal attenuation setting (dB)							
	0.25 dB	10 dB	15 dB	20 dB	30 dB	40 dB	50 dB	60 dB
1	0.00	0.32	0.34	0.81	1.28	1.01	1.26	1.24
5	0.00	0.31	0.33	0.80	1.28	1.00	1.25	1.20
10	0.00	0.31	0.33	0.80	1.27	1.00	1.24	1.23
20	0.00	0.31	0.33	0.80	1.27	1.00	1.26	1.25
50	0.00	0.32	0.34	0.81	1.28	1.01	1.26	1.24
100	0.00	0.32	0.34	0.81	1.29	1.02	1.26	1.24
200	0.00	0.36	0.39	0.85	1.33	1.06	1.30	1.28
500	0.01	0.47	0.54	1.00	1.49	1.23	1.45	1.46
750	0.02	0.56	0.66	1.12	1.61	1.36	1.58	1.60
1000	0.02	0.58	0.69	1.14	1.63	1.39	1.59	1.59
1500	0.02	0.47	0.54	0.97	1.43	1.20	1.37	1.34
2000	0.01	0.34	0.36	0.73	1.16	0.92	1.02	0.90
2500	0.02	0.27	0.27	0.55	0.94	0.71	0.70	0.53
3000	0.02	0.34	0.38	0.57	0.93	0.75	0.63	0.42
3500	0.02	0.20	0.22	0.36	0.67	0.61	0.42	0.19
4000	0.00	-0.30	-0.41	-0.43	-0.22	-0.28	-0.51	-0.77
4500	-0.01	-0.68	-0.86	-1.19	-1.04	-1.14	-1.50	-1.58
5000	-0.01	-0.67	-0.66	-1.19	-0.98	-0.82	-1.34	-1.17
5500	0.03	-0.15	0.01	-0.50	-0.31	0.43	0.02	0.23
6000	0.01	-0.64	-0.66	-1.45	-1.38	-0.40	-0.61	-0.13

**Notes**

- A. Performance and quality attributes and conditions not expressly stated in this specification document are intended to be excluded and do not form a part of this specification document.
- B. Electrical specifications and performance data contained in this specification document are based on Mini-Circuit's applicable established test performance criteria and measurement instructions.
- C. The parts covered by this specification document are subject to Mini-Circuit's standard limited warranty and terms and conditions (collectively, "Standard Terms"). Purchasers of this part are entitled to the rights and benefits contained therein. For a full statement of the Standard Terms and the exclusive rights and remedies thereunder, please visit Mini-Circuit's website at [www.minicircuits.com/MCStore/terms.jsp](http://www.minicircuits.com/MCStore/terms.jsp)



# Programmable Attenuator RUDAT-6000-60

## Typical Performance Data @ 0°C

FREQUENCY (MHz)	Input VSWR (:1)							
	0.25 dB	10 dB	15 dB	20 dB	30 dB	40 dB	50 dB	60 dB
1	1.55	1.25	1.17	1.10	1.16	1.04	1.05	1.04
5	1.53	1.25	1.16	1.09	1.15	1.01	1.04	1.01
10	1.53	1.25	1.16	1.09	1.15	1.01	1.04	1.01
20	1.53	1.25	1.16	1.09	1.15	1.01	1.04	1.00
50	1.53	1.25	1.16	1.09	1.15	1.01	1.04	1.01
100	1.52	1.25	1.16	1.09	1.15	1.01	1.04	1.01
200	1.49	1.24	1.17	1.10	1.16	1.02	1.05	1.02
500	1.29	1.18	1.14	1.09	1.15	1.01	1.05	1.01
750	1.11	1.14	1.12	1.08	1.15	1.02	1.05	1.02
1000	1.07	1.12	1.11	1.08	1.15	1.02	1.06	1.02
1500	1.44	1.22	1.16	1.11	1.16	1.03	1.06	1.03
2000	1.65	1.31	1.22	1.16	1.18	1.05	1.07	1.05
2500	1.43	1.28	1.22	1.17	1.17	1.09	1.07	1.09
3000	1.31	1.21	1.18	1.17	1.16	1.15	1.11	1.15
3500	1.54	1.28	1.25	1.26	1.20	1.25	1.21	1.25
4000	1.45	1.32	1.32	1.36	1.29	1.39	1.36	1.39
4500	1.25	1.22	1.31	1.41	1.41	1.55	1.54	1.56
5000	1.15	1.38	1.46	1.58	1.58	1.75	1.77	1.76
5500	1.70	1.73	1.75	1.83	1.80	1.98	2.02	1.99
6000	1.62	1.76	1.84	1.96	2.00	2.23	2.29	2.22

FREQUENCY (MHz)	Output VSWR (:1)							
	0.25 dB	10 dB	15 dB	20 dB	30 dB	40 dB	50 dB	60 dB
1	1.57	1.13	1.06	1.08	1.04	1.07	1.06	1.04
5	1.55	1.12	1.05	1.07	1.01	1.06	1.04	1.02
10	1.55	1.12	1.04	1.07	1.00	1.06	1.04	1.01
20	1.55	1.12	1.04	1.07	1.00	1.06	1.04	1.01
50	1.55	1.12	1.05	1.07	1.00	1.06	1.04	1.02
100	1.54	1.12	1.05	1.07	1.00	1.06	1.05	1.02
200	1.50	1.12	1.05	1.08	1.01	1.07	1.06	1.03
500	1.26	1.07	1.04	1.06	1.03	1.06	1.05	1.03
750	1.05	1.04	1.03	1.05	1.03	1.06	1.05	1.03
1000	1.16	1.07	1.06	1.06	1.04	1.06	1.05	1.04
1500	1.57	1.18	1.13	1.10	1.08	1.07	1.07	1.06
2000	1.72	1.25	1.20	1.14	1.15	1.09	1.10	1.11
2500	1.40	1.19	1.19	1.14	1.19	1.11	1.12	1.15
3000	1.30	1.18	1.22	1.16	1.23	1.16	1.17	1.20
3500	1.62	1.26	1.31	1.23	1.31	1.25	1.24	1.27
4000	1.46	1.22	1.32	1.29	1.38	1.37	1.35	1.36
4500	1.16	1.18	1.33	1.37	1.47	1.52	1.49	1.48
5000	1.27	1.40	1.48	1.55	1.60	1.69	1.65	1.62
5500	1.68	1.67	1.70	1.81	1.78	1.92	1.87	1.81
6000	1.67	1.77	1.83	2.01	1.98	2.21	2.15	2.05

**Notes**

- A. Performance and quality attributes and conditions not expressly stated in this specification document are intended to be excluded and do not form a part of this specification document.
- B. Electrical specifications and performance data contained in this specification document are based on Mini-Circuit's applicable established test performance criteria and measurement instructions.
- C. The parts covered by this specification document are subject to Mini-Circuits standard limited warranty and terms and conditions (collectively, "Standard Terms"). Purchasers of this part are entitled to the rights and benefits contained therein. For a full statement of the Standard Terms and the exclusive rights and remedies thereunder, please visit Mini-Circuits' website at [www.minicircuits.com/MCStore/terms.jsp](http://www.minicircuits.com/MCStore/terms.jsp)



# Programmable Attenuator RUDAT-6000-60

## Typical Performance Data @ 0°C

FREQUENCY (MHz)	IP3 (dBm)	Insertion Loss @P <sub>IN</sub> =0 dBm (dB)	Insertion Loss @P <sub>IN</sub> =+20 dBm (dB)
1	49.80	-	-
200	53.56	2.26	2.10
500	54.05	3.10	2.94
1000	54.77	3.35	3.21
2000	55.49	3.55	3.42
3000	53.69	3.96	3.83
4000	51.89	4.42	4.26
5000	49.96	4.88	4.68
6000	48.03	5.61	5.45

**Notes**

- A. Performance and quality attributes and conditions not expressly stated in this specification document are intended to be excluded and do not form a part of this specification document.  
B. Electrical specifications and performance data contained in this specification document are based on Mini-Circuit's applicable established test performance criteria and measurement instructions.  
C. The parts covered by this specification document are subject to Mini-Circuits standard limited warranty and terms and conditions (collectively, "Standard Terms"). Purchasers of this part are entitled to the rights and benefits contained therein. For a full statement of the Standard Terms and the exclusive rights and remedies thereunder, please visit Mini-Circuits' website at [www.minicircuits.com/ACLStore/terms.jsp](http://www.minicircuits.com/ACLStore/terms.jsp)





# Programmable Attenuator RUDAT-6000-60

## Typical Performance Data @ +25°C

FREQUENCY (MHz)	Attenuation relative to Insertion Loss (dB)							
	0.25 dB	10 dB	15 dB	20 dB	30 dB	40 dB	50 dB	60 dB
1	0.25	9.65	14.62	19.17	28.69	38.97	48.76	58.77
5	0.25	9.66	14.63	19.18	28.69	38.98	48.76	58.72
10	0.25	9.66	14.63	19.18	28.70	38.99	48.76	58.78
20	0.25	9.66	14.63	19.18	28.70	38.99	48.76	58.76
50	0.25	9.66	14.63	19.17	28.69	38.98	48.75	58.71
100	0.25	9.65	14.62	19.18	28.69	38.98	48.75	58.74
200	0.25	9.63	14.59	19.14	28.65	38.95	48.72	58.69
500	0.23	9.50	14.42	18.97	28.48	38.76	48.56	58.53
750	0.23	9.43	14.31	18.87	28.37	38.63	48.44	58.40
1000	0.22	9.41	14.30	18.86	28.36	38.62	48.43	58.43
1500	0.23	9.52	14.44	19.03	28.56	38.81	48.66	58.70
2000	0.24	9.64	14.60	19.25	28.81	39.06	48.98	59.09
2500	0.23	9.70	14.68	19.41	29.01	39.25	49.28	59.43
3000	0.22	9.64	14.58	19.40	29.03	39.22	49.37	59.53
3500	0.23	9.78	14.75	19.63	29.31	39.39	49.62	59.88
4000	0.24	10.25	15.35	20.38	30.16	40.23	50.49	60.74
4500	0.25	10.62	15.76	21.10	30.93	41.04	51.46	61.56
5000	0.26	10.62	15.59	21.13	30.91	40.75	51.33	61.21
5500	0.22	10.15	14.98	20.50	30.32	39.59	50.10	59.87
6000	0.24	10.63	15.64	21.43	31.37	40.40	50.71	60.29

FREQUENCY (MHz)	Attenuation accuracy relative to nominal attenuation setting (dB)							
	0.25 dB	10 dB	15 dB	20 dB	30 dB	40 dB	50 dB	60 dB
1	0.00	0.35	0.38	0.83	1.31	1.03	1.24	1.23
5	0.00	0.34	0.37	0.82	1.31	1.02	1.24	1.28
10	0.00	0.34	0.37	0.82	1.30	1.01	1.24	1.22
20	0.00	0.34	0.37	0.82	1.30	1.01	1.24	1.24
50	0.00	0.34	0.38	0.83	1.31	1.02	1.25	1.29
100	0.00	0.35	0.38	0.82	1.31	1.02	1.25	1.26
200	0.00	0.37	0.41	0.86	1.35	1.05	1.28	1.31
500	0.02	0.50	0.58	1.03	1.52	1.24	1.44	1.47
750	0.02	0.57	0.69	1.13	1.63	1.37	1.56	1.60
1000	0.03	0.59	0.70	1.14	1.64	1.38	1.57	1.57
1500	0.02	0.48	0.56	0.97	1.44	1.19	1.34	1.30
2000	0.01	0.36	0.40	0.75	1.19	0.94	1.02	0.91
2500	0.02	0.30	0.32	0.59	0.99	0.75	0.72	0.57
3000	0.03	0.36	0.42	0.60	0.97	0.78	0.63	0.47
3500	0.02	0.22	0.25	0.37	0.69	0.61	0.38	0.12
4000	0.01	-0.25	-0.35	-0.38	-0.16	-0.23	-0.49	-0.74
4500	0.00	-0.62	-0.76	-1.10	-0.93	-1.04	-1.46	-1.56
5000	-0.01	-0.62	-0.59	-1.13	-0.91	-0.75	-1.33	-1.21
5500	0.03	-0.15	0.02	-0.50	-0.32	0.41	-0.10	0.13
6000	0.01	-0.63	-0.64	-1.43	-1.37	-0.40	-0.71	-0.29

**Notes**

- A. Performance and quality attributes and conditions not expressly stated in this specification document are intended to be excluded and do not form a part of this specification document.
- B. Electrical specifications and performance data contained in this specification document are based on Mini-Circuits' applicable established test performance criteria and measurement instructions.
- C. The parts covered by this specification document are subject to Mini-Circuits' standard limited warranty and terms and conditions (collectively, "Standard Terms"). Purchasers of this part are entitled to the rights and benefits contained therein. For a full statement of the Standard Terms and the exclusive rights and remedies thereunder, please visit Mini-Circuits' website at [www.minicircuits.com/ACL/Store/terms.jsp](http://www.minicircuits.com/ACL/Store/terms.jsp)



# Programmable Attenuator RUDAT-6000-60

## Typical Performance Data @ +25°C

FREQUENCY (MHz)	Input VSWR (:1)							
	0.25 dB	10 dB	15 dB	20 dB	30 dB	40 dB	50 dB	60 dB
1	1.56	1.28	1.20	1.13	1.19	1.05	1.08	1.05
5	1.55	1.28	1.19	1.12	1.19	1.04	1.07	1.03
10	1.55	1.28	1.19	1.12	1.18	1.03	1.07	1.03
20	1.55	1.28	1.19	1.12	1.18	1.03	1.07	1.03
50	1.55	1.28	1.19	1.12	1.18	1.04	1.07	1.03
100	1.54	1.27	1.19	1.12	1.18	1.04	1.07	1.03
200	1.50	1.26	1.18	1.12	1.18	1.04	1.07	1.04
500	1.30	1.21	1.16	1.11	1.18	1.04	1.08	1.04
750	1.11	1.16	1.14	1.11	1.18	1.05	1.09	1.05
1000	1.07	1.14	1.14	1.11	1.19	1.06	1.09	1.06
1500	1.45	1.25	1.19	1.14	1.20	1.07	1.10	1.07
2000	1.65	1.32	1.24	1.18	1.20	1.08	1.09	1.07
2500	1.43	1.29	1.23	1.19	1.19	1.09	1.08	1.09
3000	1.32	1.22	1.19	1.18	1.17	1.14	1.10	1.14
3500	1.55	1.27	1.24	1.25	1.18	1.23	1.18	1.23
4000	1.45	1.31	1.31	1.34	1.27	1.36	1.33	1.36
4500	1.24	1.21	1.30	1.39	1.38	1.52	1.51	1.53
5000	1.14	1.38	1.45	1.56	1.56	1.72	1.73	1.73
5500	1.69	1.73	1.74	1.81	1.79	1.96	1.99	1.96
6000	1.63	1.77	1.85	1.96	2.00	2.21	2.28	2.21

FREQUENCY (MHz)	Output VSWR (:1)							
	0.25 dB	10 dB	15 dB	20 dB	30 dB	40 dB	50 dB	60 dB
1	1.59	1.16	1.08	1.11	1.05	1.10	1.08	1.06
5	1.57	1.15	1.07	1.10	1.03	1.09	1.07	1.04
10	1.57	1.15	1.07	1.10	1.03	1.09	1.07	1.04
20	1.57	1.15	1.07	1.10	1.03	1.09	1.07	1.04
50	1.57	1.15	1.07	1.10	1.03	1.09	1.07	1.04
100	1.55	1.14	1.07	1.10	1.03	1.09	1.07	1.04
200	1.51	1.14	1.07	1.10	1.03	1.09	1.08	1.05
500	1.27	1.10	1.06	1.09	1.04	1.09	1.08	1.05
750	1.05	1.06	1.05	1.08	1.05	1.09	1.08	1.06
1000	1.16	1.09	1.07	1.09	1.06	1.09	1.09	1.07
1500	1.59	1.21	1.15	1.13	1.10	1.10	1.09	1.09
2000	1.71	1.26	1.21	1.15	1.15	1.10	1.10	1.11
2500	1.40	1.20	1.20	1.14	1.18	1.11	1.12	1.14
3000	1.31	1.19	1.22	1.15	1.23	1.15	1.15	1.18
3500	1.63	1.26	1.30	1.21	1.29	1.22	1.21	1.24
4000	1.46	1.21	1.30	1.26	1.36	1.33	1.31	1.32
4500	1.15	1.17	1.31	1.34	1.45	1.48	1.45	1.44
5000	1.25	1.39	1.48	1.54	1.59	1.67	1.63	1.60
5500	1.67	1.67	1.71	1.81	1.78	1.93	1.87	1.80
6000	1.68	1.78	1.83	2.02	1.98	2.21	2.15	2.05

**Notes**

- A. Performance and quality attributes and conditions not expressly stated in this specification document are intended to be excluded and do not form a part of this specification document.
- B. Electrical specifications and performance data contained in this specification document are based on Mini-Circuit's applicable established test performance criteria and measurement instructions.
- C. The parts covered by this specification document are subject to Mini-Circuit's standard limited warranty and terms and conditions (collectively, "Standard Terms"). Purchasers of this part are entitled to the rights and benefits contained therein. For a full statement of the Standard Terms and the exclusive rights and remedies thereunder, please visit Mini-Circuit's website at [www.minicircuits.com/MAC/Store/terms.jsp](http://www.minicircuits.com/MAC/Store/terms.jsp)



# Programmable Attenuator RUDAT-6000-60

## Typical Performance Data @ +25°C

FREQUENCY (MHz)	IP3 (dBm)	Insertion Loss @P <sub>IN</sub> =0 dBm (dB)	Insertion Loss @P <sub>IN</sub> =+20 dBm (dB)
1	49.10	-	-
200	53.40	2.40	2.24
500	55.78	3.07	2.91
1000	55.44	3.21	3.08
2000	55.09	3.46	3.33
3000	53.45	3.96	3.84
4000	51.81	4.39	4.25
5000	47.97	4.82	4.66
6000	44.12	5.71	5.58

### Notes

- A. Performance and quality attributes and conditions not expressly stated in this specification document are intended to be excluded and do not form a part of this specification document.  
B. Electrical specifications and performance data contained in this specification document are based on Mini-Circuit's applicable established test performance criteria and measurement instructions.  
C. The parts covered by this specification document are subject to Mini-Circuits standard limited warranty and terms and conditions (collectively, "Standard Terms"). Purchasers of this part are entitled to the rights and benefits contained therein. For a full statement of the Standard Terms and the exclusive rights and remedies thereunder, please visit Mini-Circuits' website at [www.minicircuits.com/MAC/Store/terms.jsp](http://www.minicircuits.com/MAC/Store/terms.jsp)



# Programmable Attenuator RUDAT-6000-60

## Typical Performance Data @ +50°C

FREQUENCY (MHz)	Attenuation relative to Insertion Loss (dB)							
	0.25 dB	10 dB	15 dB	20 dB	30 dB	40 dB	50 dB	60 dB
1	0.25	9.60	14.54	19.10	28.59	38.90	48.68	58.60
5	0.25	9.61	14.56	19.11	28.60	38.91	48.69	58.67
10	0.25	9.61	14.56	19.11	28.60	38.91	48.68	58.64
20	0.25	9.61	14.56	19.12	28.61	38.92	48.68	58.64
50	0.25	9.60	14.55	19.11	28.60	38.91	48.68	58.62
100	0.25	9.61	14.55	19.12	28.60	38.92	48.69	58.65
200	0.25	9.58	14.52	19.08	28.57	38.88	48.66	58.60
500	0.23	9.46	14.35	18.91	28.39	38.68	48.48	58.42
750	0.22	9.39	14.25	18.82	28.30	38.57	48.38	58.30
1000	0.22	9.38	14.24	18.81	28.30	38.56	48.38	58.30
1500	0.23	9.47	14.38	18.98	28.48	38.74	48.59	58.59
2000	0.23	9.58	14.52	19.18	28.71	38.97	48.90	58.98
2500	0.23	9.63	14.58	19.31	28.89	39.12	49.16	59.30
3000	0.22	9.58	14.50	19.32	28.92	39.10	49.25	59.39
3500	0.23	9.71	14.66	19.54	29.19	39.28	49.52	59.76
4000	0.24	10.15	15.22	20.24	29.99	40.07	50.35	60.62
4500	0.25	10.51	15.63	20.94	30.76	40.86	51.32	61.44
5000	0.25	10.52	15.45	20.99	30.75	40.62	51.26	61.10
5500	0.22	10.05	14.85	20.38	30.18	39.48	50.07	59.90
6000	0.24	10.54	15.51	21.27	31.21	40.26	50.63	60.24

FREQUENCY (MHz)	Attenuation accuracy relative to nominal attenuation setting (dB)							
	0.25 dB	10 dB	15 dB	20 dB	30 dB	40 dB	50 dB	60 dB
1	0.00	0.40	0.46	0.90	1.41	1.10	1.32	1.40
5	0.00	0.39	0.44	0.89	1.40	1.09	1.31	1.33
10	0.00	0.39	0.44	0.89	1.40	1.09	1.32	1.36
20	0.00	0.39	0.44	0.88	1.39	1.08	1.32	1.36
50	0.00	0.40	0.45	0.89	1.40	1.09	1.32	1.38
100	0.00	0.39	0.45	0.88	1.40	1.08	1.31	1.35
200	0.00	0.42	0.48	0.92	1.43	1.12	1.34	1.40
500	0.02	0.54	0.65	1.09	1.61	1.32	1.52	1.58
750	0.03	0.61	0.75	1.18	1.70	1.43	1.62	1.70
1000	0.03	0.62	0.76	1.19	1.70	1.44	1.62	1.70
1500	0.02	0.53	0.62	1.02	1.52	1.26	1.41	1.41
2000	0.02	0.42	0.48	0.82	1.29	1.03	1.10	1.02
2500	0.02	0.37	0.42	0.69	1.11	0.88	0.84	0.70
3000	0.03	0.42	0.50	0.68	1.08	0.90	0.75	0.61
3500	0.02	0.29	0.34	0.46	0.81	0.72	0.48	0.24
4000	0.01	-0.15	-0.22	-0.24	0.01	-0.07	-0.35	-0.62
4500	0.00	-0.51	-0.63	-0.94	-0.76	-0.86	-1.32	-1.44
5000	0.00	-0.52	-0.45	-0.99	-0.75	-0.62	-1.26	-1.10
5500	0.03	-0.05	0.15	-0.38	-0.18	0.52	-0.07	0.10
6000	0.01	-0.54	-0.51	-1.27	-1.21	-0.26	-0.63	-0.24

**Notes**

- A. Performance and quality attributes and conditions not expressly stated in this specification document are intended to be excluded and do not form a part of this specification document.
- B. Electrical specifications and performance data contained in this specification document are based on Mini-Circuit's applicable established test performance criteria and measurement instructions.
- C. The parts covered by this specification document are subject to Mini-Circuit's standard limited warranty and terms and conditions (collectively, "Standard Terms"). Purchasers of this part are entitled to the rights and benefits contained therein. For a full statement of the Standard Terms and the exclusive rights and remedies thereunder, please visit Mini-Circuit's website at [www.minicircuits.com/MCLStore/terms.jsp](http://www.minicircuits.com/MCLStore/terms.jsp)



# Programmable Attenuator RUDAT-6000-60

## Typical Performance Data @ +50°C

FREQUENCY (MHz)	Input VSWR (:1)							
	0.25 dB	10 dB	15 dB	20 dB	30 dB	40 dB	50 dB	60 dB
1	1.60	1.33	1.24	1.17	1.24	1.08	1.12	1.08
5	1.58	1.33	1.24	1.16	1.23	1.07	1.11	1.07
10	1.58	1.33	1.24	1.16	1.23	1.07	1.11	1.07
20	1.58	1.32	1.24	1.16	1.23	1.07	1.11	1.07
50	1.58	1.32	1.23	1.16	1.23	1.07	1.11	1.07
100	1.57	1.31	1.23	1.16	1.22	1.07	1.11	1.07
200	1.52	1.30	1.22	1.15	1.22	1.07	1.10	1.07
500	1.31	1.24	1.20	1.15	1.22	1.08	1.12	1.08
750	1.11	1.18	1.17	1.14	1.22	1.08	1.12	1.09
1000	1.07	1.17	1.17	1.14	1.22	1.09	1.13	1.09
1500	1.46	1.28	1.22	1.17	1.24	1.10	1.14	1.10
2000	1.66	1.35	1.27	1.21	1.24	1.11	1.13	1.11
2500	1.44	1.32	1.26	1.21	1.23	1.11	1.11	1.11
3000	1.35	1.25	1.22	1.20	1.19	1.13	1.10	1.13
3500	1.57	1.28	1.25	1.25	1.18	1.21	1.16	1.21
4000	1.46	1.32	1.31	1.34	1.26	1.34	1.30	1.34
4500	1.23	1.22	1.30	1.39	1.37	1.51	1.49	1.51
5000	1.16	1.39	1.46	1.56	1.56	1.71	1.73	1.72
5500	1.73	1.73	1.74	1.80	1.78	1.94	1.98	1.94
6000	1.61	1.75	1.83	1.92	1.97	2.16	2.23	2.15

FREQUENCY (MHz)	Output VSWR (:1)							
	0.25 dB	10 dB	15 dB	20 dB	30 dB	40 dB	50 dB	60 dB
1	1.62	1.20	1.12	1.15	1.08	1.14	1.12	1.09
5	1.61	1.19	1.11	1.14	1.07	1.13	1.12	1.08
10	1.61	1.19	1.11	1.14	1.06	1.13	1.12	1.08
20	1.60	1.19	1.11	1.14	1.06	1.13	1.12	1.08
50	1.60	1.19	1.11	1.14	1.06	1.13	1.11	1.08
100	1.58	1.18	1.10	1.13	1.06	1.13	1.11	1.08
200	1.53	1.17	1.10	1.13	1.06	1.12	1.11	1.08
500	1.29	1.13	1.09	1.13	1.07	1.13	1.12	1.09
750	1.06	1.09	1.08	1.12	1.08	1.14	1.12	1.10
1000	1.17	1.11	1.10	1.12	1.09	1.14	1.13	1.10
1500	1.61	1.24	1.18	1.16	1.13	1.14	1.13	1.12
2000	1.71	1.29	1.23	1.18	1.17	1.12	1.13	1.13
2500	1.40	1.21	1.21	1.15	1.19	1.11	1.12	1.15
3000	1.31	1.19	1.22	1.14	1.21	1.12	1.12	1.16
3500	1.64	1.26	1.29	1.18	1.27	1.19	1.17	1.21
4000	1.47	1.20	1.29	1.22	1.33	1.29	1.26	1.28
4500	1.13	1.16	1.30	1.31	1.43	1.45	1.41	1.41
5000	1.25	1.38	1.46	1.51	1.57	1.65	1.60	1.57
5500	1.69	1.67	1.69	1.79	1.76	1.91	1.85	1.78
6000	1.66	1.76	1.80	1.98	1.93	2.17	2.11	2.00

**Notes**

- A. Performance and quality attributes and conditions not expressly stated in this specification document are intended to be excluded and do not form a part of this specification document.
- B. Electrical specifications and performance data contained in this specification document are based on Mini-Circuit's applicable established test performance criteria and measurement instructions.
- C. The parts covered by this specification document are subject to Mini-Circuit's standard limited warranty and terms and conditions (collectively, "Standard Terms"). Purchasers of this part are entitled to the rights and benefits contained therein. For a full statement of the Standard Terms and the exclusive rights and remedies thereunder, please visit Mini-Circuit's website at [www.minicircuits.com/MCLStore/terms.jsp](http://www.minicircuits.com/MCLStore/terms.jsp)



# Programmable Attenuator RUDAT-6000-60

## Typical Performance Data @ +50°C

FREQUENCY (MHz)	IP3 (dBm)	Insertion Loss @P <sub>IN</sub> =0 dBm (dB)	Insertion Loss @P <sub>IN</sub> =+20 dBm (dB)
1	48.32	-	-
200	53.74	2.51	2.34
500	54.22	3.33	3.17
1000	54.46	3.59	3.44
2000	54.70	3.82	3.67
3000	53.17	4.27	4.12
4000	51.63	4.83	4.66
5000	49.30	5.39	5.20
6000	46.96	6.12	5.96

### Notes

- A. Performance and quality attributes and conditions not expressly stated in this specification document are intended to be excluded and do not form a part of this specification document.  
B. Electrical specifications and performance data contained in this specification document are based on Mini-Circuit's applicable established test performance criteria and measurement instructions.  
C. The parts covered by this specification document are subject to Mini-Circuit's standard limited warranty and terms and conditions (collectively, "Standard Terms"). Purchasers of this part are entitled to the rights and benefits contained therein. For a full statement of the Standard Terms and the exclusive rights and remedies thereunder, please visit Mini-Circuit's website at [www.minicircuits.com/MCLStore/terms.jsp](http://www.minicircuits.com/MCLStore/terms.jsp)

# Programmable Attenuator

# RUDAT-6000-60

## Typical Performance Curves @ 0°C

**Attenuation Accuracy vs. Frequency over Attenuation settings**

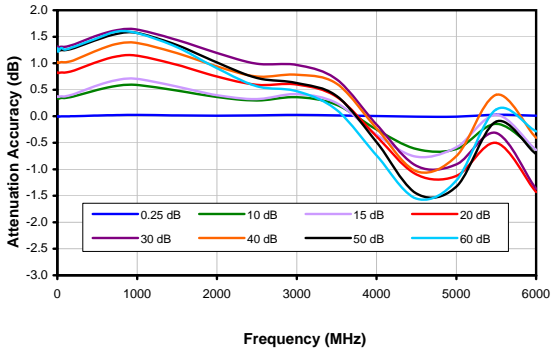

**Attenuation relative to I.L. vs. Frequency over Attenuation settings**

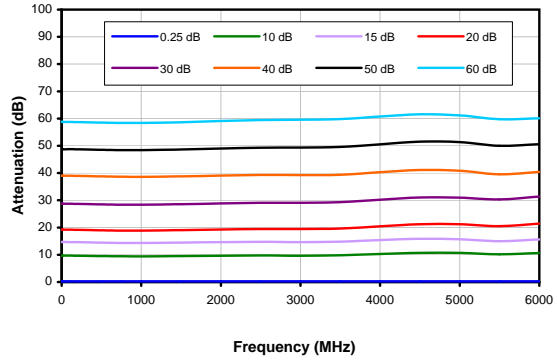

**Input VSWR vs. Frequency over Attenuation settings**

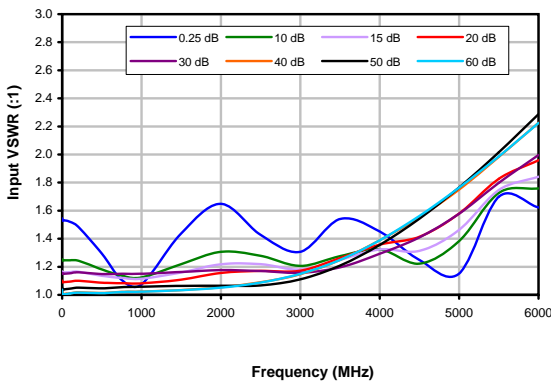

**Output VSWR vs. Frequency over Attenuation settings**

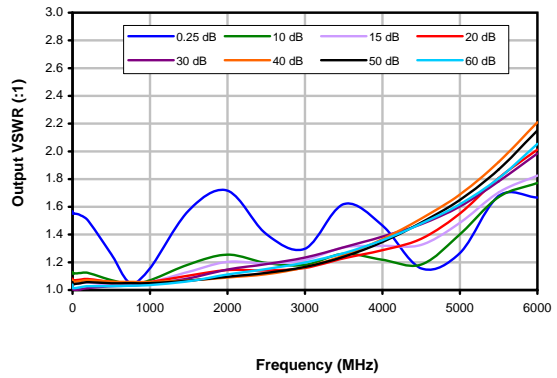

**IP3 @ 0dB Attenuation**

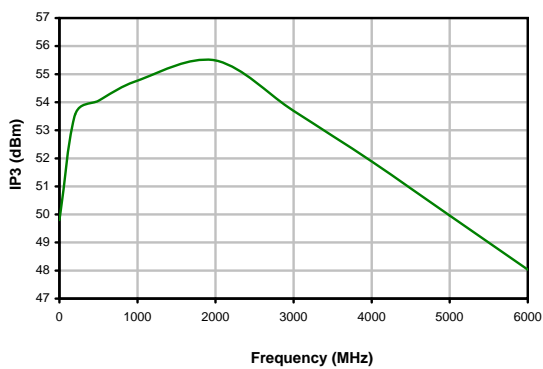

**Insertion Loss**

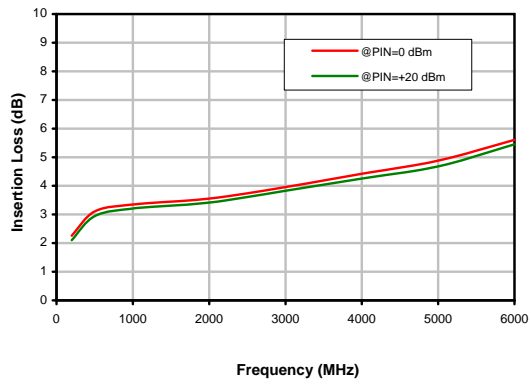

**Notes**

- A. Performance and quality attributes and conditions not expressly stated in this specification document are intended to be excluded and do not form a part of this specification document.
- B. Electrical specifications and performance data contained in this specification document are based on Mini-Circuits' applicable established test performance criteria and measurement instructions.
- C. The parts covered by this specification document are subject to Mini-Circuits' standard limited warranty and terms and conditions (collectively, "Standard Terms"). Purchasers of this part are entitled to the rights and benefits contained therein. For a full statement of the Standard Terms and the exclusive rights and remedies thereunder, please visit Mini-Circuits' website at [www.minicircuits.com/MCLStore/terms.jsp](http://www.minicircuits.com/MCLStore/terms.jsp)

# Programmable Attenuator

# RUDAT-6000-60

## Typical Performance Curves @ +25°C

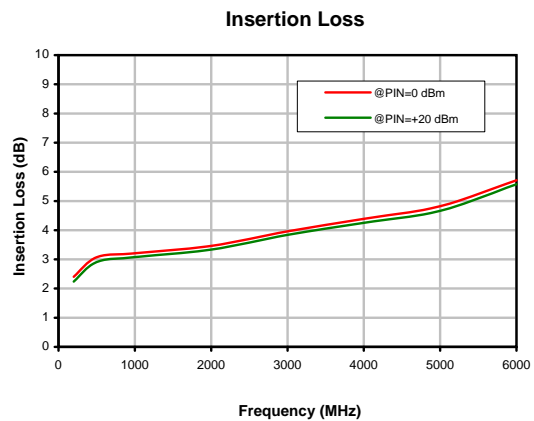
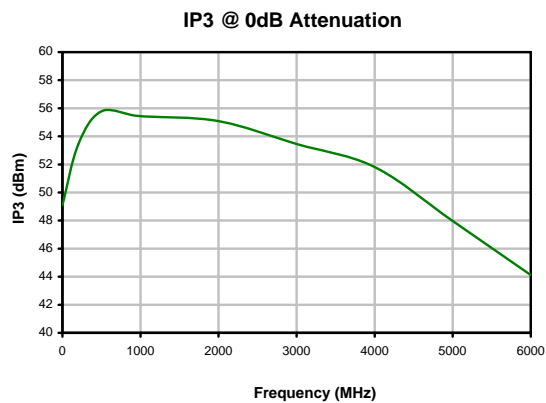
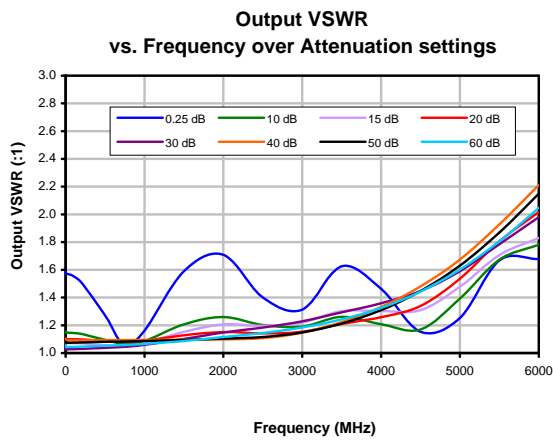
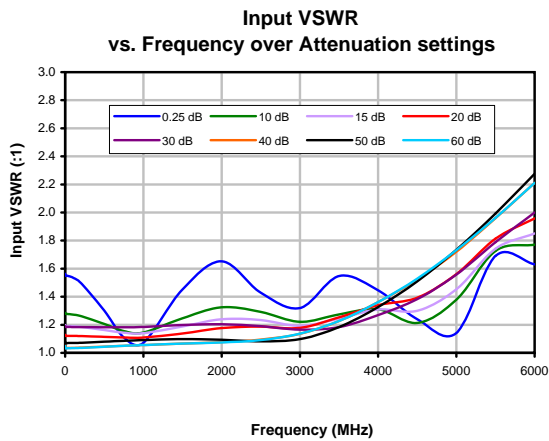
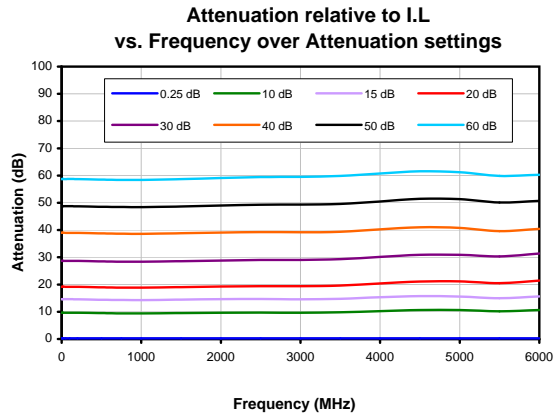
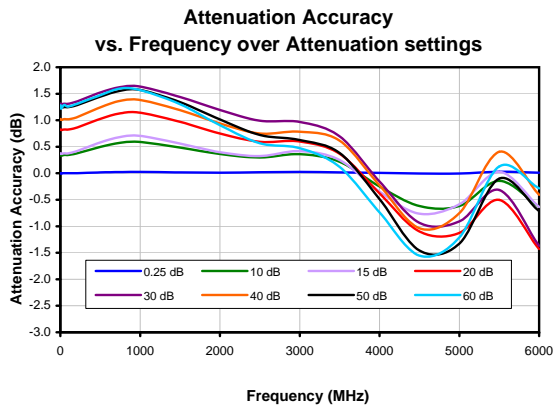

**Notes**

- A. Performance and quality attributes and conditions not expressly stated in this specification document are intended to be excluded and do not form a part of this specification document.
- B. Electrical specifications and performance data contained in this specification document are based on Mini-Circuits' applicable established test performance criteria and measurement instructions.
- C. The parts covered by this specification document are subject to Mini-Circuits' standard limited warranty and terms and conditions (collectively, "Standard Terms"). Purchasers of this part are entitled to the rights and benefits contained therein. For a full statement of the Standard Terms and the exclusive rights and remedies thereunder, please visit Mini-Circuits' website at [www.minicircuits.com/MCLStore/terms.jsp](http://www.minicircuits.com/MCLStore/terms.jsp)



# Programmable Attenuator

# RUDAT-6000-60

## Typical Performance Curves @ +50°C

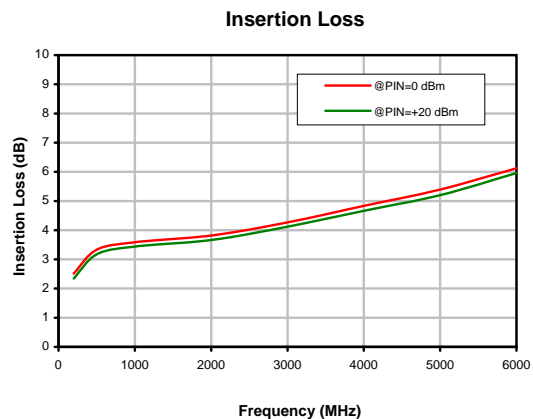
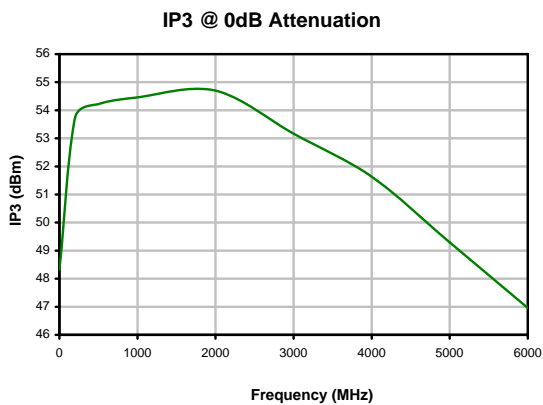
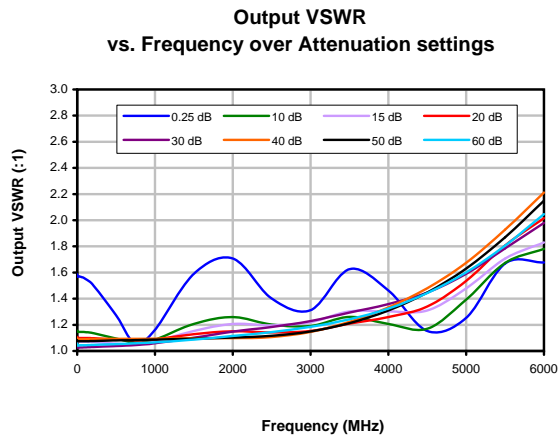
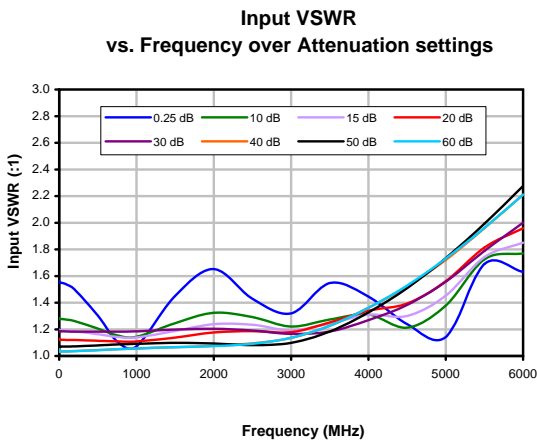
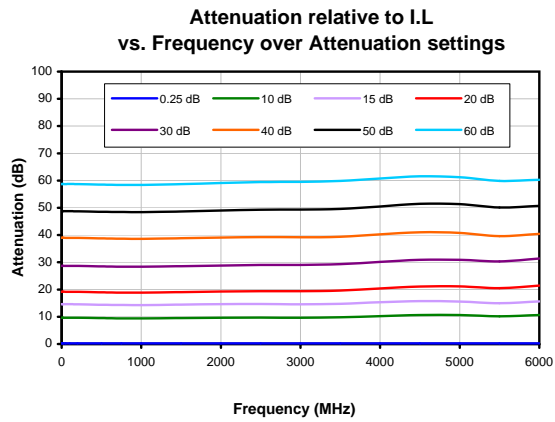
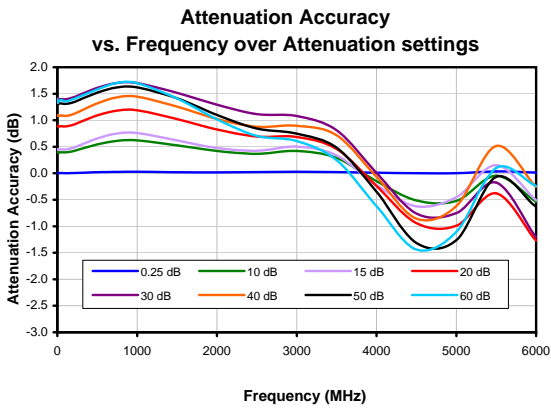

**Notes**

- A. Performance and quality attributes and conditions not expressly stated in this specification document are intended to be excluded and do not form a part of this specification document.
- B. Electrical specifications and performance data contained in this specification document are based on Mini-Circuits' applicable established test performance criteria and measurement instructions.
- C. The parts covered by this specification document are subject to Mini-Circuits' standard limited warranty and terms and conditions (collectively, "Standard Terms"). Purchasers of this part are entitled to the rights and benefits contained therein. For a full statement of the Standard Terms and the exclusive rights and remedies thereunder, please visit Mini-Circuits' website at [www.minicircuits.com/MCLStore/terms.jsp](http://www.minicircuits.com/MCLStore/terms.jsp)

## Outline Dimensions

MS1813

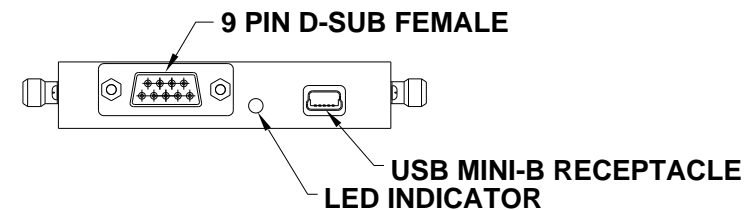

Top View

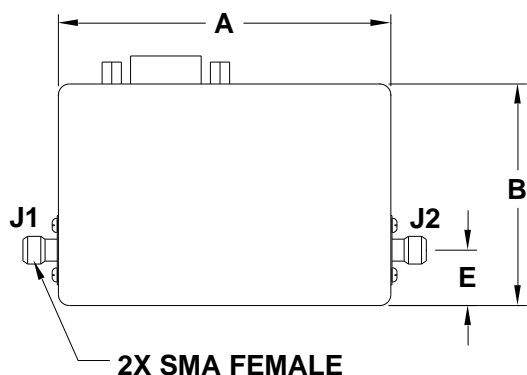

Bracket Option

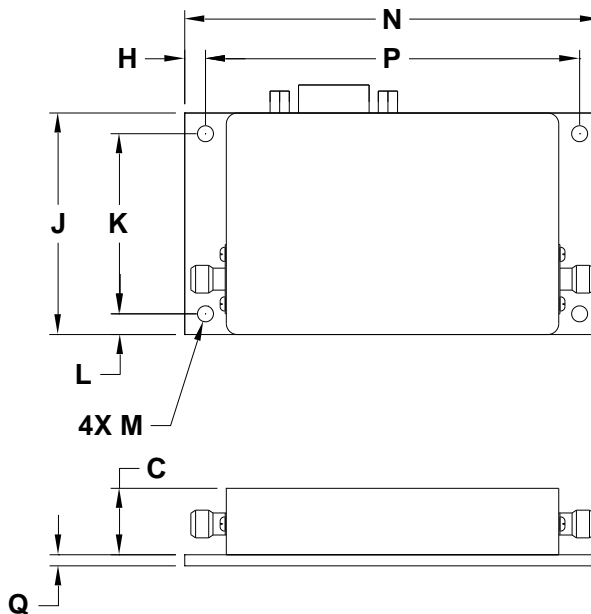

Bottom View

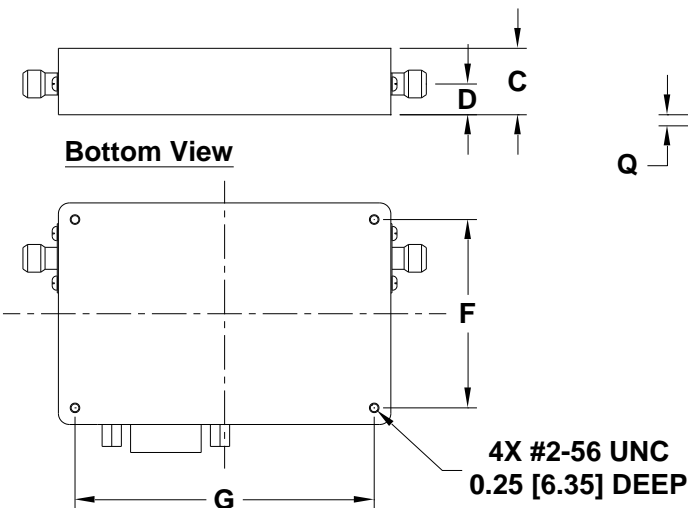

Instruction for mounting bracket:

1. Tool required: Phillips head screwdriver
2. Mount the bracket over threaded holes on the bottom side with the fasteners provided with the bracket.

CASE#	A	B	C	D	E	F	G	H	J	K	L	M	N	P	Q	WT. GRAMS
MS1813	3.00 (76.2)	2.00 (50.8)	.60 (15.2)	.28 (7.1)	.50 (12.7)	1.700 (43.18)	2.700 (68.58)	.188 (4.76)	2.00 (50.8)	1.625 (41.28)	.188 (4.76)	.144 (3.66)	3.75 (95.3)	3.375 (85.72)	.100 (2.54)	130

Dimensions are in inches (mm). Tolerances: 2PL. +/- .03; 3PL. +/- .015

### Notes:

1. Case material: Nickel Plated Aluminum.



P.O. Box 350166, Brooklyn, New York 11235-0003 (718) 934-4500 Fax (718) 332-4661 For detailed performance specs & shopping online see Mini-Circuits web site



The Design Engineers Search Engine Provides ACTUAL Data Instantly From MINI-CIRCUITS At: [www.minicircuits.com](http://www.minicircuits.com)

RF/IF MICROWAVE COMPONENTS



Environmental Specifications **ENV55T1**

All Mini-Circuits products are manufactured under exacting quality assurance and control standards, and are capable of meeting published specifications after being subjected to any or all of the following physical and environmental test.

Specification	Test/Inspection Condition	Reference/Spec
Operating Temperature	-0° to 50° C Ambient Environment	Individual Model Data Sheet
Storage Temperature	-20° to 85° C Ambient Environment	Individual Model Data Sheet
Operating and Storage Humidity	5% to 85% RH (non-condensing)	Ambient
Bench Handling Test	Bench Top Tip 45° & Drop	MIL-PRF-28800F
Transit Drop Test	Free Fall Drop, 20 cm (7.9 inches)	MIL-PRF-28800F Class 3