

Programmable Attenuator

RUDAT-4000-120

50Ω 0 – 120 dB, 0.25 dB step 1 to 4000 MHz

The Big Deal

- Wide Attenuation range, 120 dB
- Fine attenuation resolution, 0.25 dB
- Short attenuation transition time (650 ns)
- Compact size, 2.0 x 3.0 x 0.6"
- **USB and RS232** control

Applications

- Automated Test Equipment (ATE)
- WiMAX, 3G, 4G, LTE, DVB Fading Simulators
- Laboratory Instrumentation
- Handover system Evaluation
- Power level cycling

Product Overview

Mini-Circuits' RUDAT-4000-120 is a general purpose, single channel programmable attenuator suitable for a wide range of signal level control applications from 1 MHz to 4 GHz. The Attenuator provides 0 to 120 dB attenuation in 0.25 dB steps. Its unique design maintains linear attenuation change per dB, even at the highest attenuation settings.

The attenuator is housed in a compact and rugged package with SMA female connectors on the bi-directional input and output RF ports, a standard 9 pin D-Sub and a USB type Mini-B power and control ports.

The attenuator can be controlled via USB or RS232 (via D-Sub connector). Full software support is provided and can be downloaded from our website any time at <http://www.minicircuits.com/softwaredownload/patt.html>. The package includes our user-friendly GUI application for Windows® and a full API with programming instructions for Windows® and Linux® environments (both 32-bit and 64-bit systems).

Key Features

Feature	Advantages
USB control	The RUDAT-4000-120 can be controlled from any Windows® or Linux® computer with a USB connection. The device draws all power requirements through the USB port.
RS232 control	The user may also control the RUDAT-4000-120 via RS232 connection, allowing serial communication with the device.
Programmable attenuation sweep and Hop sequences	The RUDAT-4000-120 can be programmed with a timed sequence of attenuation settings, to run without any additional external control
120 dB attenuation range.	The RUDAT-4000-120 provides high-accuracy attenuation up to 120 dB in 0.25 dB steps, allowing the user precise level control over a broad attenuation and frequency range.
High linearity	Typical input IP3 of +53 dBm up to 4000 MHz

Trademarks: Windows is a registered trademark of Microsoft Corporation in the United States and other countries. Linux is a registered trademark of Linus Torvalds. Mac is a registered trademark of Apple Corporation. Pentium is a registered trademark of Intel Corporation. Neither Mini-Circuits nor the Mini-Circuits RUDAT-series attenuators are affiliated with or endorsed by the owners of the above referenced trademarks.

Mini-Circuits and the Mini-Circuits logo are registered trademarks of Scientific Components Corporation.



Software Package

Case Style: MS1813

Included Accessories

Model No.	Description	Qty.
MUSB-CBL-3+	3.3 ft. USB cable	1

RoHS Compliant

See our web site for RoHS Compliance methodologies and qualifications

Electrical Specifications ¹ at 0°C to 50°C

Parameter	Frequency range	Conditions	Min.	Typ.	Max.	Units
Attenuation range	1 - 4000 MHz	0.25 dB step	0	-	120	dB
Attenuation accuracy ²	1 - 2000 MHz	@ 0.25 - 10 dB	-	±0.15	±(0.25+8% of nominal value)	dB
		@ 10.25 - 40 dB	-	±0.55	±(0.4+5% of nominal value)	
		@ 40.25 - 90 dB	-	±0.50	±(0.8+2% of nominal value)	
		@ 90.25 - 120 dB	-	±0.70	±(-2.6+5.5% of nominal value)	
	2000 - 4000 MHz	@ 0.25 - 10 dB	-	±0.15	±(0.2+6% of nominal value)	
		@ 10.25 - 40 dB	-	±0.50	±(0.8+3% of nominal value)	
		@ 40.25 - 90 dB	-	±0.25	±(1.1+1% of nominal value)	
Insertion Loss	1 - 2000 MHz	@ 0 dB	-	6.5	8.5	dB
	2000 - 4000 MHz	@ 0 dB	-	9.0	10.5	
	Isolation In-Out	1 - 4000 MHz	Note 3	-	134	
Input operating power ⁴ (RF In and RF Out ports)	1 - 10 MHz	@ 0 - 120 dB	-	-	+10	dBm
	10 - 4000 MHz	@ 0 - 120 dB	-	-	+20	
IP3 Input ⁵	1 - 4000 MHz	@ 0 dB setting (P _{IN} =+10 dBm)	-	+53	-	dBm
VSWR	1 - 500 MHz	@ 0 - 40 dB	-	1.30	-	:1
		@ 40.25 - 120 dB	-	1.05	-	
	500 - 4000 MHz	@ 0 - 20 dB	-	1.10	-	
		@ 20.25 - 120 dB	-	1.05	-	
Min Dwell Time ⁶	1 - 4000 MHz	High speed mode	-	600	-	µsec
Attenuation Transition Time ⁷	1 - 4000 MHz	-	-	650	-	nsec
Supply Voltage ⁸	-	via USB port or D-Sub Pin#1	4.75	5	5.25	V
DC current draw	-		-	60	80	mA
RS232 logic levels	Meets RS232 standard at all voltages with RS232 communications set to 9600 bps; 8 bit word; no parity; stop bit = '1'.					

¹ Attenuator RF ports are interchangeable, and support simultaneous, bidirectional signal transmission, however the specifications are guaranteed for the RF in and RF out as noted on the label. There may be minor changes in performance when injecting signals to the RF Out port.

² Max accuracy defined as ±[absolute error+% of attenuation setting] for example when setting the attenuator to 110 dB attenuation the maximum error at 3500 MHz will be: ±(-7.0+0.1x110)= ±(-7.0+11)= ± 4.0 dB

³ Isolation is defined as max attenuation plus insertion loss; this is the path loss through the attenuator when initially powered up. After a brief delay (~0.5 sec typically) the attenuator will revert to a user defined "power-up" state (either max attenuation or a pre-set value).

⁴ Total operating input power from both RF In and RF Out out ports. Compression level not noted as it exceeds max safe operating power level.

⁵ Tested with 1 MHz span between signals.

⁶ Minimum Dwell Time is the time the RUDAT will take to respond to a command to change attenuation states without communication delays. In PC control add communication delays (on the order of msec for USB) to get actual response time.

⁷ Attenuation Transition Time is specified as the time between starting to change the attenuation state and settling on the requested attenuation state.

⁸ Power on sequence for RS232 control: Connect 5V power followed by the control lines.

Absolute Maximum Ratings

Operating Temperature	0°C to 50°C	
Storage Temperature	-20°C to 85°C	
Voltage input at RS232 receive pin	-30V to +30V	
Voltage input at RS232 transmit pin	0V to +4V	
Voltage input at RS232 Pin#1	-1V to +6V	
V _{USB} Max.	6V	
DC voltage at RF port	16V	
Total RF power for	@ 1 to 10 MHz	+13 dBm
RF In & RF Out	@ 10 to 6000 MHz	+23 dBm

Permanent damage may occur if any of these limits are exceeded.

Operation in the range between the max operating power and the absolute maximum rating for extended periods of time may result in reduced life and reliability.

RUDAT response to communication interrupt

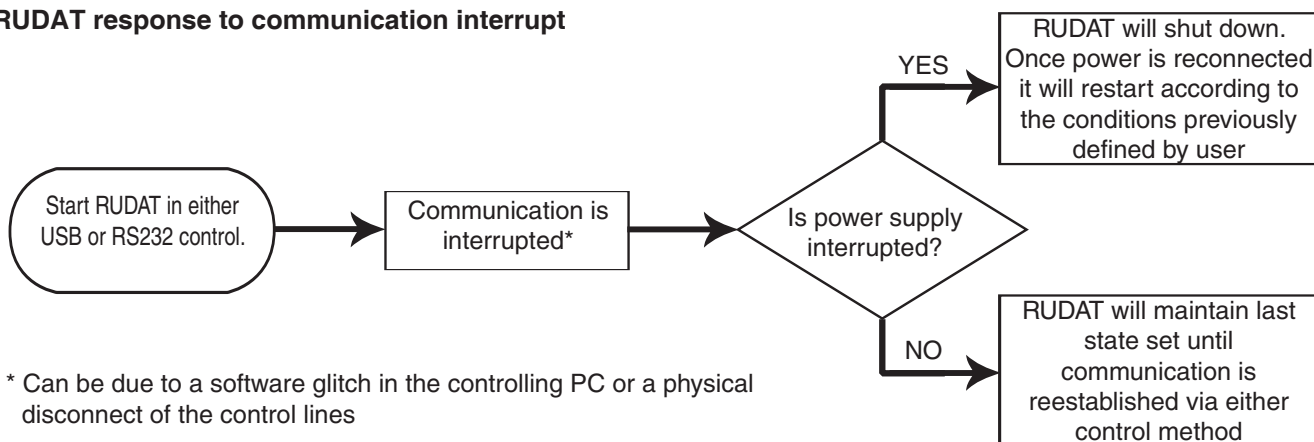

Block Diagram

The 5V_{DC} for RUDAT units may be input via the USB port or via Pin#1 of the D-Sub port.

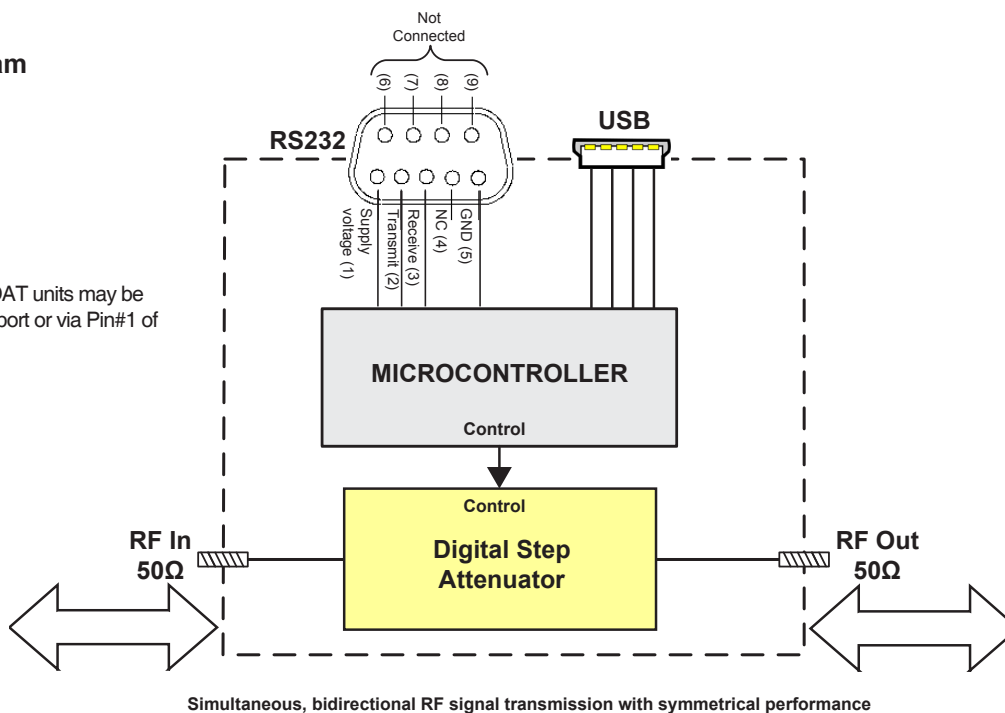

Connections

RF IN	(SMA female)
RF OUT	(SMA female)
USB	(USB type Mini-B female)
RS232*	(9 Pin D-Sub female)

*9 Pin D-Sub Pin Connections

PIN Number	Function
2	Transmit
3	Receive
5	GND
1	+5 V _{DC} ^{9,10}
4,6-9	Not Connected

⁹ Pin#1 can be used as supply voltage (+) pin instead of USB connection. When USB power is connected, Pin#1 may be connected to GND or supply voltage (+) or remain disconnected.

¹⁰ Power on sequence for RS232 control: Connect 5V power followed by the control lines.

Outline Drawing (MS1813)

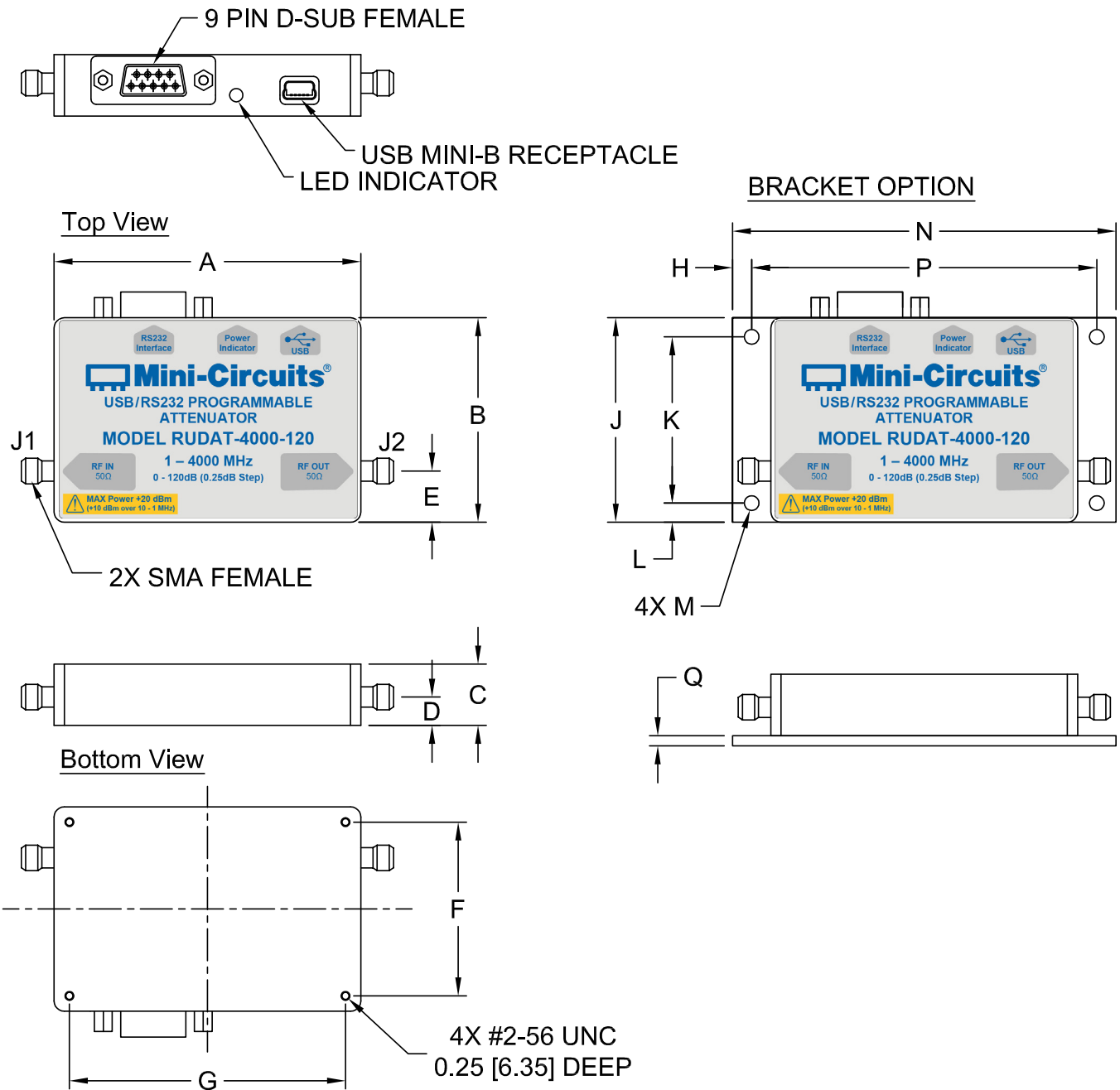

Outline Dimensions (inch mm)

A	B	C	D	E	F	G	H	J	K	L	M	N	P	Q	WT. GRAMS
3.00	2.00	0.60	0.28	0.50	1.700	2.700	0.188	2.00	1.625	0.188	0.144	3.75	3.375	0.100	130
76.2	50.8	15.24	7.1	12.7	43.18	68.58	4.76	50.80	41.28	4.76	3.66	95.25	85.72	2.54	

Typical Performance Curves

**Attenuation Accuracy @ +25°C
vs. Frequency over Attenuation settings**

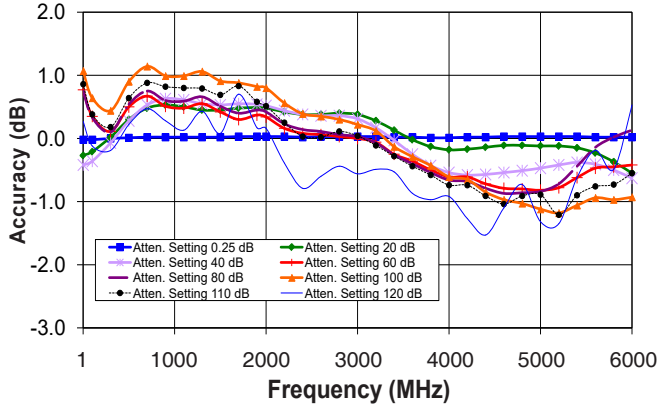

**Attenuation relative to Insertion Loss @ +25°C
vs. Frequency over Attenuation settings**

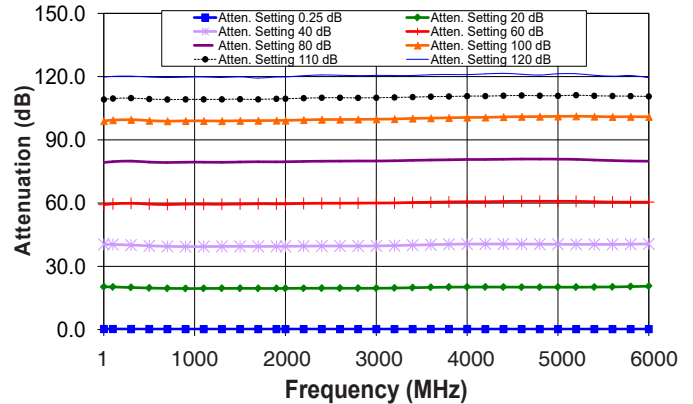

**Attenuation Accuracy @ 0°C
vs. Frequency over Attenuation settings**

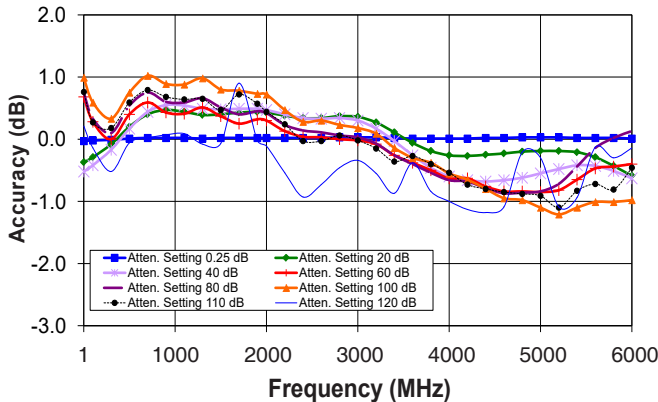

**Attenuation relative to Insertion Loss @ 0°C
vs. Frequency over Attenuation settings**

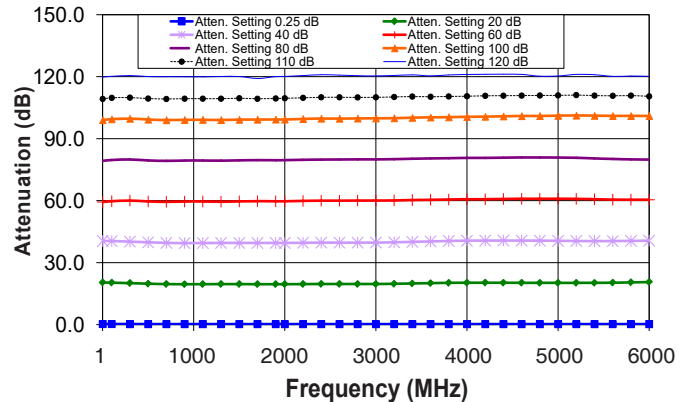

**Attenuation Accuracy @ +50°C
vs. Frequency over Attenuation settings**

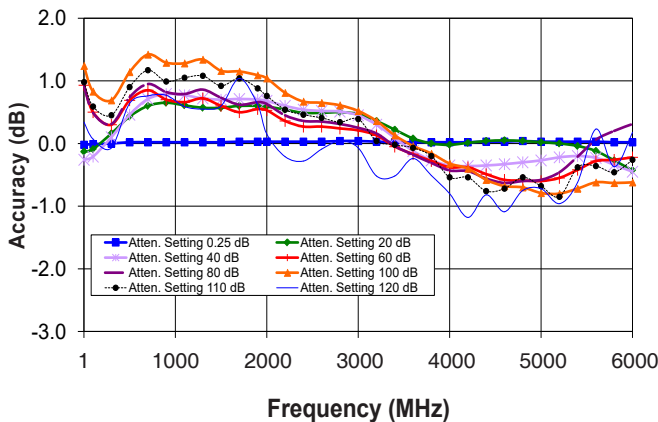

**Attenuation relative to Insertion Loss @ +50°C
vs. Frequency over Attenuation settings**

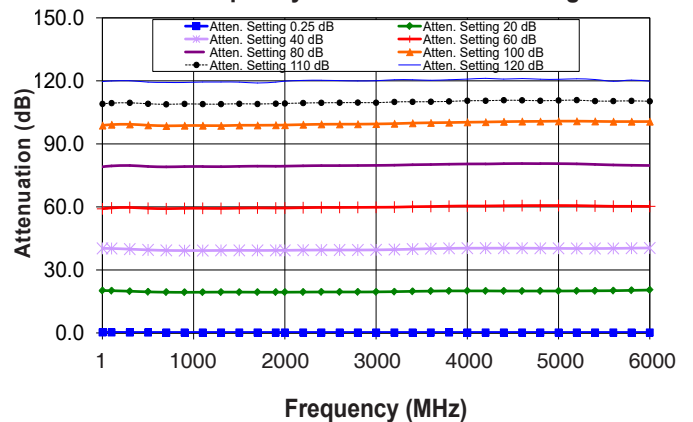

Typical Performance Curves (Continued)

Insertion Loss @ Input Power 0dBm vs. Frequency over Temperatures

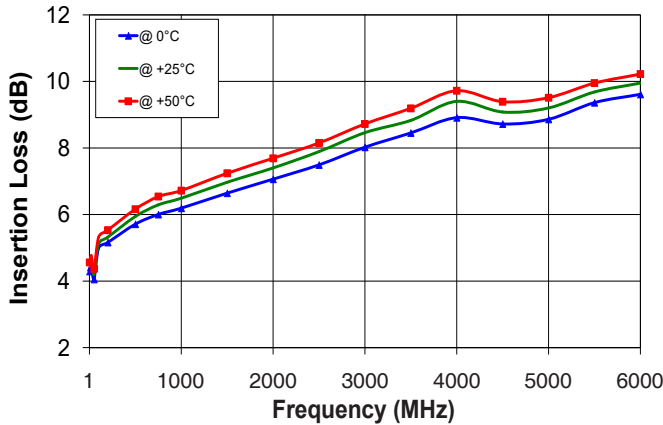

Insertion Loss @ Input Power +20 dBm vs. Frequency over Temperatures

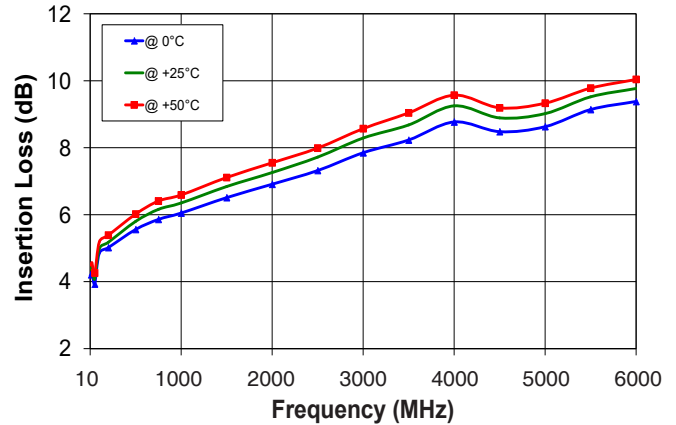

Output VSWR @ +25°C vs. Frequency over Attenuation settings

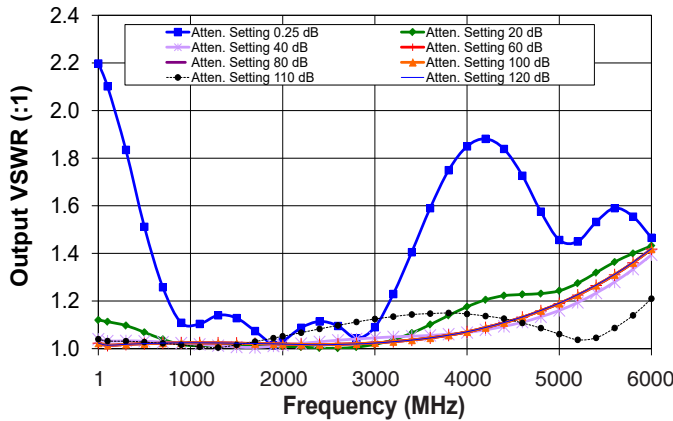

Input VSWR @ +25°C vs. Frequency over Attenuation settings

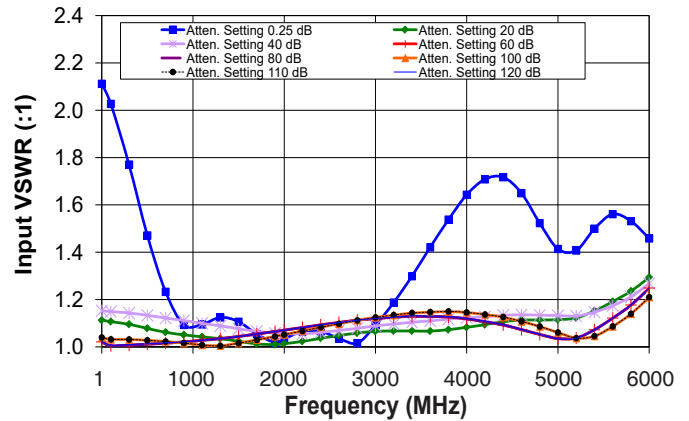

Input IP3 @ 0dB Attenuation vs. Frequency over Temperatures

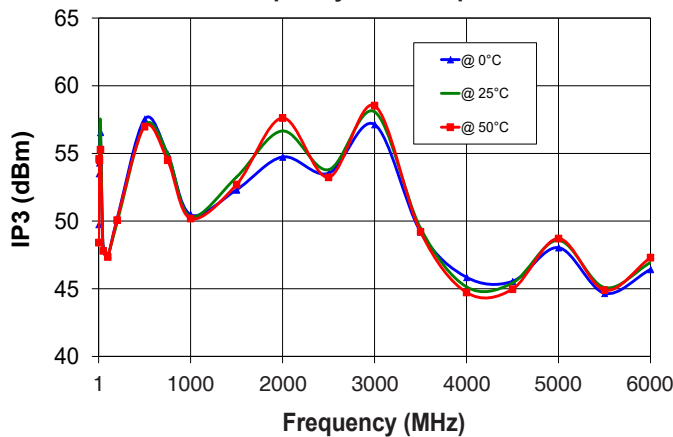

Typical Attenuation Accuracy vs. Attenuation settings over Temperature

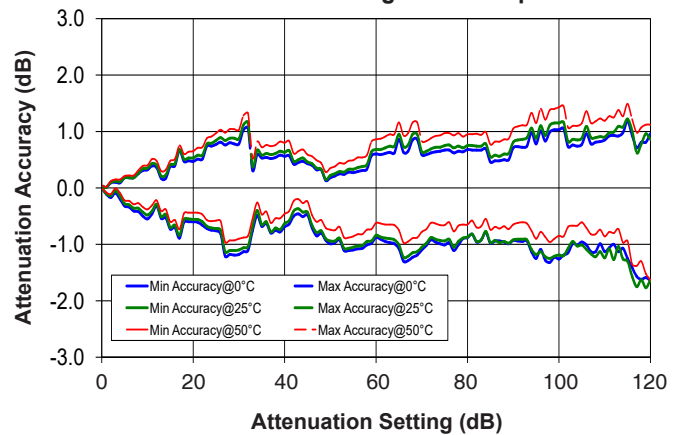

Software & Documentation Download:

- Mini-Circuits' full software and support package including user guide, Windows GUI, DLL files, programming manual and examples can be downloaded free of charge from <http://www.minicircuits.com/softwaredownload/patt.html>
- Please contact testsolutions@minicircuits.com for support

Minimum System Requirements

Parameter	Requirements	
Interface	USB HID or RS232	
System requirements	GUI:	Windows 32 & 64 bit systems from Windows 98 up to Windows 10
	USB API (ActiveX & .Net)	Windows 32 & 64 bit systems with ActiveX or .Net support from Windows 98 up to Windows 10
	USB direct programming support	Linux, Windows systems from Windows 98 up to Windows 10
	RS232	Any computer with a serial port and RS232 support
Hardware	Pentium® II or higher, RAM 256 MB	

Graphical User Interface (GUI) for Windows

Key Features:

- Manual attenuation setting
- Sweep and Hop attenuation sequences directed from the PC, or entire sequence loaded into RUDAT.
- Attenuator address configuration and Firmware upgrade
- Attenuation at power up may be set to selected attenuation level or last attenuation state recorded.
- USB or RS232 control of RUDAT

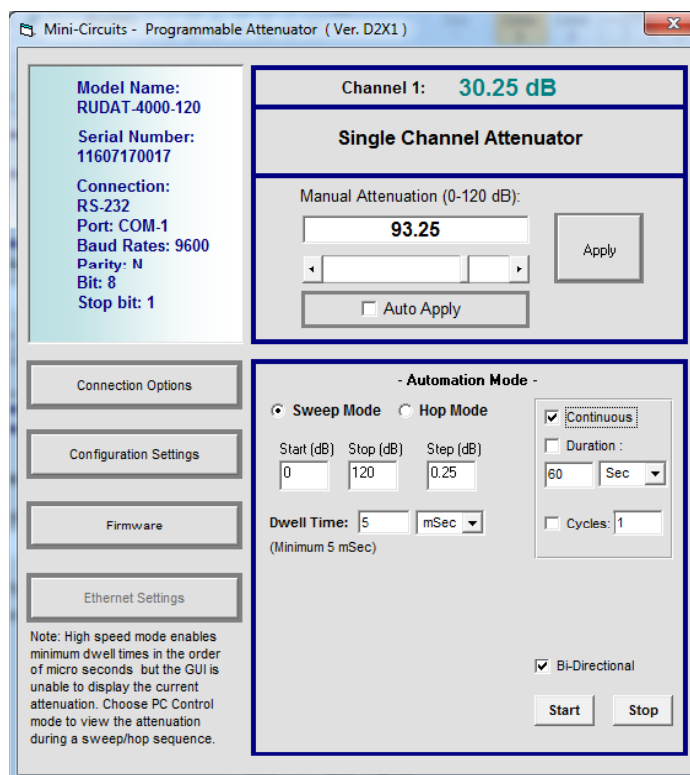

Application Programming Interface (API)

Windows Support:

- API DLL files exposing the full switch functionality See programming manual at https://www.minicircuits.com/softwaredownload/Prog_Manual-6-Programmable_Attenuator.pdf for details
 - ActiveX COM DLL file for creation of 32-bit programs
 - .Net library DLL file for creation of 32 / 64-bit programs
- Supported by most common programming environments (refer to application note [AN-49-001](#) for summary of tested environments)

Linux Support:

- Full switch control in a Linux environment is achieved by way of USB interrupt commands. See programming manual at https://www.minicircuits.com/softwaredownload/Prog_Manual-6-Programmable_Attenuator.pdf for details

Ordering Information

Model	Description
RUDAT-4000-120	USB/RS232 Programmable Attenuator

Included Accessories	Part No.	Description
	MUSB-CBL-3+	3.3 ft (1.0 m) USB Cable: USB type A(Male) to USB type Mini-B(Male)

Optional Accessories	Description
USB-AC/DC-5 ^{11,12}	AC/DC 5V _{DC} Power Adapter with US, EU, IL, UK, AUS, and China power plugs
MUSB-CBL-3+ (spare)	3.3 ft (1.0 m) USB Cable: USB type A(Male) to USB type Mini-B(Male)
MUSB-CBL-7+	6.6 ft (2.0 m) USB Cable: USB type A(Male) to USB type Mini-B(Male)
D-SUB9-MF-6+	6 ft RS232 Cable: 9 pin D-sub(Male) to 9 pin D-sub(Female)
BKT-3901+	Bracket kit including 3.75" x 2.00" bracket, mounting screws and washers

¹¹ Not used in USB control. USB-AC/DC-5 can be used to provide the 5V_{DC} power when control is via RS232; units can also accept DC supply voltage at Pin#1 of the D-sub connector.

¹² Power plugs for other countries are also available, if you need a power plug for a country not listed please contact testsolutions@minicircuits.com

Additional Notes

- A. Performance and quality attributes and conditions not expressly stated in this specification document are intended to be excluded and do not form a part of this specification document.
- B. Electrical specifications and performance data contained in this specification document are based on Mini-Circuit's applicable established test performance criteria and measurement instructions.
- C. The parts covered by this specification document are subject to Mini-Circuits standard limited warranty and terms and conditions (collectively, "Standard Terms"); Purchasers of this part are entitled to the rights and benefits contained therein. For a full statement of the Standard Terms and the exclusive rights and remedies thereunder, please visit Mini-Circuits' website at www.minicircuits.com/MCLStore/terms.jsp



Programmable Attenuator

RUDAT-4000-120

Typical Performance Data @ 0°C

FREQUENCY (MHz)	Attenuation relative to Insertion Loss (dB)							
	0.25 dB	20 dB	40 dB	60 dB	80 dB	100 dB	110 dB	120 dB
1	0.28	20.37	40.52	59.32	79.31	99.01	109.24	119.79
5	0.28	20.37	40.52	59.43	79.42	99.12	109.35	119.79
10	0.28	20.37	40.52	59.55	79.54	99.25	109.45	120.03
20	0.28	20.36	40.51	59.5	79.5	99.21	109.36	119.88
50	0.27	20.32	40.47	59.53	79.52	99.22	109.47	119.93
100	0.27	20.29	40.43	59.72	79.72	99.41	109.73	120.14
200	0.27	20.19	40.31	59.88	79.87	99.58	109.77	120.27
500	0.24	19.8	39.83	59.61	79.56	99.25	109.41	120.06
750	0.23	19.57	39.52	59.41	79.33	98.99	109.18	119.89
1000	0.23	19.54	39.44	59.64	79.54	99.18	109.39	119.77
1500	0.23	19.6	39.52	59.63	79.5	99.2	109.53	120.07
2000	0.23	19.57	39.53	59.7	79.58	99.28	109.56	120.11
2500	0.23	19.67	39.67	59.96	79.87	99.71	110.09	121.17
3000	0.22	19.64	39.7	60.02	79.99	99.82	110.02	120.34
3500	0.23	19.98	40.15	60.35	80.34	100.22	110.5	120.72
4000	0.24	20.26	40.6	60.63	80.62	100.55	110.54	121.01
4500	0.23	20.24	40.68	60.82	80.85	100.85	110.74	121.17
5000	0.22	20.19	40.55	60.86	80.85	101.1	110.91	120.3
5500	0.23	20.24	40.41	60.55	80.25	101.03	110.83	120.36
6000	0.24	20.59	40.63	60.4	79.77	100.98	110.46	120.14

FREQUENCY (MHz)	Attenuation accuracy relative to nominal attenuation setting (dB)							
	0.25 dB	20 dB	40 dB	60 dB	80 dB	100 dB	110 dB	120 dB
1	-0.03	-0.37	-0.52	0.68	0.69	0.99	0.76	0.21
5	-0.03	-0.37	-0.52	0.57	0.58	0.88	0.65	0.21
10	-0.03	-0.37	-0.52	0.46	0.46	0.75	0.55	-0.03
20	-0.03	-0.36	-0.51	0.5	0.5	0.79	0.64	0.12
50	-0.02	-0.32	-0.47	0.47	0.48	0.78	0.54	0.07
100	-0.02	-0.29	-0.42	0.28	0.28	0.59	0.27	-0.14
200	-0.01	-0.19	-0.31	0.12	0.13	0.42	0.23	-0.27
500	0.01	0.2	0.17	0.4	0.44	0.75	0.59	-0.06
750	0.02	0.43	0.48	0.59	0.68	1.01	0.82	0.11
1000	0.02	0.46	0.56	0.36	0.46	0.82	0.61	0.23
1500	0.02	0.4	0.48	0.37	0.5	0.8	0.47	-0.07
2000	0.02	0.43	0.47	0.3	0.42	0.72	0.44	-0.11
2500	0.02	0.33	0.33	0.04	0.13	0.29	-0.09	-1.17
3000	0.03	0.36	0.3	-0.02	0.01	0.18	-0.02	-0.34
3500	0.02	0.02	-0.15	-0.35	-0.34	-0.22	-0.5	-0.72
4000	0.01	-0.26	-0.6	-0.63	-0.62	-0.55	-0.54	-1
4500	0.02	-0.24	-0.68	-0.82	-0.85	-0.85	-0.74	-1.17
5000	0.03	-0.19	-0.55	-0.85	-0.85	-1.1	-0.91	-0.3
5500	0.02	-0.24	-0.41	-0.55	-0.25	-1.03	-0.82	-0.36
6000	0.01	-0.59	-0.63	-0.4	0.24	-0.98	-0.46	-0.14

Notes

- A. Performance and quality attributes and conditions not expressly stated in this specification document are intended to be excluded and do not form a part of this specification document.
- B. Electrical specifications and performance data contained in this specification document are based on Mini-Circuit's applicable established test performance criteria and measurement instructions.
- C. The parts covered by this specification document are subject to Mini-Circuits standard limited warranty and terms and conditions (collectively, "Standard Terms"); Purchasers of this part are entitled to the rights and benefits contained therein. For a full statement of the Standard Terms and the exclusive rights and remedies thereunder, please visit Mini-Circuits' website at www.minicircuits.com/MCLStore/terms.jsp



Programmable Attenuator

RUDAT-4000-120

Typical Performance Data @ 0°C

FREQUENCY (MHz)	IP3 (dBm)	Insertion Loss @P _{IN} =0 dBm (dB)	Insertion Loss @P _{IN} =+20 dBm (dB)
1	49.76	4.29	4.12
5	53.52	4.33	4.15
10	54.31	4.41	4.21
20	56.56	4.48	4.28
50	48.03	4.05	3.93
100	47.44	4.99	4.85
200	50.13	5.16	5.02
500	57.53	5.71	5.56
750	54.95	6	5.86
1000	50.47	6.19	6.05
1500	52.31	6.64	6.51
2000	54.74	7.06	6.91
2500	53.53	7.49	7.32
3000	57.14	8.02	7.85
3500	49.21	8.45	8.23
4000	45.85	8.91	8.77
4500	45.54	8.72	8.48
5000	48.04	8.86	8.63
5500	44.67	9.36	9.14
6000	46.43	9.61	9.38

Notes

- A. Performance and quality attributes and conditions not expressly stated in this specification document are intended to be excluded and do not form a part of this specification document.
B. Electrical specifications and performance data contained in this specification document are based on Mini-Circuit's applicable established test performance criteria and measurement instructions.
C. The parts covered by this specification document are subject to Mini-Circuit's standard limited warranty and terms and conditions (collectively, "Standard Terms"); Purchasers of this part are entitled to the rights and benefits contained therein. For a full statement of the Standard Terms and the exclusive rights and remedies thereunder, please visit Mini-Circuit's website at www.minicircuits.com/MCLStore/terms.jsp



Programmable Attenuator

RUDAT-4000-120

Typical Performance Data @ +25°C

FREQUENCY (MHz)	Attenuation relative to Insertion Loss (dB)							
	0.25 dB	20 dB	40 dB	60 dB	80 dB	100 dB	110 dB	120 dB
1	0.27	20.27	40.42	59.23	79.25	98.93	109.14	119.73
5	0.27	20.27	40.42	59.33	79.34	99.02	109.26	119.82
10	0.27	20.27	40.42	59.44	79.46	99.13	109.39	119.96
20	0.27	20.26	40.41	59.39	79.42	99.1	109.3	119.69
50	0.27	20.23	40.38	59.42	79.45	99.13	109.35	119.64
100	0.27	20.21	40.36	59.65	79.67	99.36	109.62	120.12
200	0.26	20.12	40.24	59.81	79.82	99.5	109.72	120.22
500	0.24	19.7	39.72	59.5	79.46	99.1	109.36	119.78
750	0.23	19.5	39.43	59.34	79.26	98.85	109.12	119.65
1000	0.23	19.48	39.37	59.56	79.46	99.03	109.28	119.72
1500	0.23	19.55	39.47	59.58	79.49	99.09	109.31	119.92
2000	0.22	19.52	39.48	59.66	79.58	99.2	109.49	119.84
2500	0.23	19.63	39.64	59.92	79.87	99.65	109.96	120.72
3000	0.22	19.62	39.69	60	79.97	99.78	109.96	120.56
3500	0.23	19.95	40.14	60.33	80.35	100.26	110.46	121.02
4000	0.24	20.18	40.54	60.61	80.66	100.61	110.74	120.92
4500	0.23	20.13	40.56	60.78	80.86	100.92	110.87	121.26
5000	0.22	20.12	40.47	60.82	80.84	101.12	110.89	121.32
5500	0.23	20.18	40.38	60.54	80.28	101.01	110.81	120.61
6000	0.23	20.55	40.63	60.42	79.87	100.93	110.55	119.47

FREQUENCY (MHz)	Attenuation accuracy relative to nominal attenuation setting (dB)							
	0.25 dB	20 dB	40 dB	60 dB	80 dB	100 dB	110 dB	120 dB
1	-0.02	-0.27	-0.42	0.77	0.75	1.07	0.86	0.27
5	-0.02	-0.27	-0.42	0.67	0.66	0.98	0.74	0.18
10	-0.02	-0.27	-0.42	0.56	0.54	0.87	0.61	0.04
20	-0.02	-0.26	-0.41	0.61	0.58	0.9	0.7	0.32
50	-0.02	-0.23	-0.38	0.58	0.55	0.87	0.65	0.36
100	-0.02	-0.21	-0.36	0.35	0.33	0.64	0.38	-0.12
200	-0.01	-0.12	-0.24	0.19	0.18	0.5	0.28	-0.22
500	0.01	0.3	0.28	0.5	0.54	0.9	0.64	0.22
750	0.02	0.5	0.57	0.66	0.74	1.15	0.88	0.35
1000	0.02	0.52	0.63	0.44	0.54	0.97	0.72	0.28
1500	0.02	0.45	0.53	0.42	0.51	0.91	0.69	0.08
2000	0.03	0.48	0.52	0.34	0.42	0.8	0.51	0.16
2500	0.03	0.37	0.36	0.08	0.14	0.35	0.04	-0.72
3000	0.03	0.38	0.31	0	0.03	0.22	0.04	-0.56
3500	0.02	0.05	-0.14	-0.33	-0.35	-0.26	-0.46	-1.02
4000	0.01	-0.18	-0.54	-0.61	-0.66	-0.61	-0.74	-0.92
4500	0.02	-0.13	-0.56	-0.78	-0.86	-0.92	-0.87	-1.26
5000	0.03	-0.12	-0.47	-0.82	-0.84	-1.12	-0.89	-1.32
5500	0.02	-0.18	-0.38	-0.54	-0.28	-1.01	-0.81	-0.61
6000	0.02	-0.55	-0.63	-0.42	0.13	-0.93	-0.55	0.53

Notes

- A. Performance and quality attributes and conditions not expressly stated in this specification document are intended to be excluded and do not form a part of this specification document.
- B. Electrical specifications and performance data contained in this specification document are based on Mini-Circuit's applicable established test performance criteria and measurement instructions.
- C. The parts covered by this specification document are subject to Mini-Circuits standard limited warranty and terms and conditions (collectively, "Standard Terms"); Purchasers of this part are entitled to the rights and benefits contained therein. For a full statement of the Standard Terms and the exclusive rights and remedies thereunder, please visit Mini-Circuits' website at www.minicircuits.com/MCLStore/terms.jsp



Programmable Attenuator

RUDAT-4000-120

Typical Performance Data @ +25°C

FREQUENCY (MHz)	Input VSWR (:1)							
	0.25 dB	20 dB	40 dB	60 dB	80 dB	100 dB	110 dB	120 dB
1	2.11	1.11	1.15	1.02	1.02	1.04	1.04	1.02
5	2.11	1.11	1.15	1.02	1.02	1.04	1.04	1.02
10	2.10	1.11	1.15	1.01	1.01	1.03	1.03	1.01
20	2.10	1.11	1.15	1.01	1.01	1.03	1.03	1.01
50	2.08	1.11	1.15	1.01	1.01	1.03	1.03	1.01
100	2.03	1.11	1.15	1.00	1.00	1.03	1.03	1.01
200	1.92	1.10	1.15	1.01	1.01	1.03	1.03	1.01
500	1.47	1.08	1.13	1.01	1.01	1.03	1.03	1.01
750	1.19	1.06	1.12	1.02	1.02	1.02	1.02	1.02
1000	1.08	1.05	1.11	1.02	1.02	1.01	1.01	1.02
1500	1.11	1.02	1.08	1.04	1.04	1.02	1.02	1.04
2000	1.03	1.01	1.06	1.07	1.07	1.05	1.05	1.07
2500	1.05	1.04	1.06	1.10	1.10	1.09	1.09	1.10
3000	1.09	1.07	1.09	1.12	1.12	1.12	1.12	1.12
3500	1.36	1.07	1.11	1.13	1.13	1.15	1.15	1.13
4000	1.64	1.08	1.12	1.12	1.12	1.15	1.15	1.12
4500	1.69	1.11	1.14	1.08	1.08	1.12	1.12	1.08
5000	1.41	1.11	1.13	1.03	1.04	1.06	1.06	1.03
5500	1.54	1.17	1.16	1.10	1.10	1.06	1.06	1.10
6000	1.46	1.29	1.27	1.25	1.25	1.21	1.21	1.25

FREQUENCY (MHz)	Output VSWR (:1)							
	0.25 dB	20 dB	40 dB	60 dB	80 dB	100 dB	110 dB	120 dB
1	2.20	1.12	1.04	1.02	1.02	1.02	1.02	1.02
5	2.20	1.12	1.04	1.02	1.02	1.02	1.02	1.02
10	2.19	1.12	1.03	1.01	1.01	1.01	1.01	1.01
20	2.18	1.12	1.03	1.01	1.01	1.01	1.01	1.01
50	2.17	1.12	1.03	1.01	1.01	1.01	1.01	1.01
100	2.10	1.11	1.03	1.01	1.01	1.01	1.01	1.01
200	1.99	1.11	1.03	1.02	1.02	1.02	1.02	1.02
500	1.51	1.07	1.03	1.02	1.02	1.02	1.02	1.02
750	1.21	1.03	1.03	1.02	1.02	1.02	1.02	1.02
1000	1.09	1.01	1.02	1.02	1.02	1.02	1.02	1.02
1500	1.13	1.02	1.01	1.02	1.02	1.02	1.02	1.02
2000	1.03	1.01	1.01	1.02	1.02	1.02	1.02	1.02
2500	1.11	1.00	1.03	1.02	1.02	1.02	1.02	1.02
3000	1.09	1.02	1.04	1.02	1.02	1.02	1.02	1.02
3500	1.50	1.08	1.05	1.04	1.04	1.04	1.04	1.04
4000	1.85	1.18	1.07	1.07	1.07	1.07	1.07	1.07
4500	1.79	1.23	1.10	1.12	1.12	1.12	1.12	1.12
5000	1.46	1.24	1.16	1.19	1.19	1.19	1.19	1.19
5500	1.57	1.34	1.26	1.29	1.29	1.29	1.29	1.29
6000	1.47	1.43	1.39	1.42	1.42	1.42	1.42	1.42

Notes

- A. Performance and quality attributes and conditions not expressly stated in this specification document are intended to be excluded and do not form a part of this specification document.
- B. Electrical specifications and performance data contained in this specification document are based on Mini-Circuit's applicable established test performance criteria and measurement instructions.
- C. The parts covered by this specification document are subject to Mini-Circuits standard limited warranty and terms and conditions (collectively, "Standard Terms"); Purchasers of this part are entitled to the rights and benefits contained therein. For a full statement of the Standard Terms and the exclusive rights and remedies thereunder, please visit Mini-Circuits' website at www.minicircuits.com/MCLStore/terms.jsp



Programmable Attenuator

RUDAT-4000-120

Typical Performance Data @ +25°C

FREQUENCY (MHz)	IP3 (dBm)	Insertion Loss @P _{IN} =0 dBm (dB)	Insertion Loss @P _{IN} =+20 dBm (dB)
1	48.77	4.44	4.26
5	55.78	4.48	4.29
10	54.79	4.56	4.36
20	56.87	4.63	4.43
50	47.73	4.20	4.08
100	47.31	5.12	4.99
200	50.04	5.32	5.18
500	56.98	5.94	5.80
750	55.38	6.29	6.16
1000	50.24	6.49	6.35
1500	52.38	6.97	6.84
2000	57.19	7.40	7.26
2500	54.40	7.89	7.72
3000	58.32	8.46	8.29
3500	49.13	8.83	8.68
4000	45.22	9.40	9.25
4500	45.47	9.08	8.89
5000	48.66	9.20	9.02
5500	45.30	9.68	9.52
6000	47.10	9.95	9.77

Notes

- A. Performance and quality attributes and conditions not expressly stated in this specification document are intended to be excluded and do not form a part of this specification document.
B. Electrical specifications and performance data contained in this specification document are based on Mini-Circuit's applicable established test performance criteria and measurement instructions.
C. The parts covered by this specification document are subject to Mini-Circuit's standard limited warranty and terms and conditions (collectively, "Standard Terms"); Purchasers of this part are entitled to the rights and benefits contained therein. For a full statement of the Standard Terms and the exclusive rights and remedies thereunder, please visit Mini-Circuit's website at www.minicircuits.com/MCLStore/terms.jsp



Programmable Attenuator

RUDAT-4000-120

Typical Performance Data @ 50°C

FREQUENCY (MHz)	Attenuation relative to Insertion Loss (dB)							
	0.25 dB	20 dB	40 dB	60 dB	80 dB	100 dB	110 dB	120 dB
1	0.27	20.13	40.26	59.07	79.08	98.76	109.02	119.66
5	0.27	20.13	40.27	59.17	79.19	98.85	109.14	119.49
10	0.27	20.13	40.26	59.28	79.31	98.96	109.23	119.63
20	0.27	20.12	40.26	59.24	79.26	98.91	109.13	119.61
50	0.27	20.1	40.23	59.27	79.29	98.96	109.17	119.67
100	0.27	20.09	40.21	59.5	79.51	99.17	109.41	119.93
200	0.26	19.99	40.08	59.64	79.65	99.28	109.52	119.99
500	0.24	19.57	39.54	59.31	79.26	98.86	109.1	119.36
750	0.23	19.38	39.25	59.15	79.05	98.58	108.87	119.13
1000	0.23	19.37	39.21	59.37	79.24	98.78	108.98	119.45
1500	0.23	19.43	39.3	59.4	79.27	98.84	109.09	119.4
2000	0.22	19.41	39.32	59.47	79.37	98.96	109.24	119.85
2500	0.22	19.51	39.48	59.72	79.64	99.35	109.58	120.14
3000	0.22	19.53	39.55	59.79	79.75	99.48	109.61	120.07
3500	0.23	19.86	40.02	60.13	80.13	99.98	110.15	120.77
4000	0.23	20.02	40.35	60.38	80.43	100.32	110.54	120.8
4500	0.22	19.96	40.34	60.55	80.62	100.65	110.69	120.84
5000	0.22	19.98	40.27	60.6	80.58	100.79	110.68	120.72
5500	0.22	20.07	40.21	60.34	80.06	100.67	110.39	120.1
6000	0.23	20.43	40.45	60.22	79.69	100.62	110.26	119.82

FREQUENCY (MHz)	Attenuation accuracy relative to nominal attenuation setting (dB)							
	0.25 dB	20 dB	40 dB	60 dB	80 dB	100 dB	110 dB	120 dB
1	-0.02	-0.13	-0.26	0.93	0.92	1.24	0.98	0.34
5	-0.02	-0.13	-0.26	0.83	0.81	1.15	0.86	0.51
10	-0.02	-0.13	-0.26	0.72	0.69	1.04	0.77	0.37
20	-0.02	-0.12	-0.26	0.76	0.74	1.09	0.87	0.39
50	-0.02	-0.09	-0.23	0.73	0.71	1.04	0.83	0.33
100	-0.01	-0.09	-0.21	0.5	0.49	0.83	0.59	0.07
200	-0.01	0.01	-0.08	0.36	0.35	0.72	0.48	0.01
500	0.02	0.43	0.46	0.69	0.74	1.14	0.9	0.64
750	0.02	0.62	0.75	0.85	0.95	1.42	1.13	0.87
1000	0.02	0.63	0.79	0.63	0.76	1.22	1.02	0.55
1500	0.02	0.57	0.7	0.6	0.73	1.16	0.92	0.6
2000	0.03	0.59	0.68	0.53	0.63	1.04	0.76	0.15
2500	0.03	0.49	0.53	0.28	0.36	0.65	0.43	-0.14
3000	0.04	0.47	0.45	0.21	0.25	0.52	0.39	-0.07
3500	0.02	0.14	-0.01	-0.13	-0.13	0.02	-0.15	-0.77
4000	0.02	-0.02	-0.35	-0.38	-0.43	-0.32	-0.54	-0.8
4500	0.03	0.04	-0.34	-0.55	-0.62	-0.65	-0.69	-0.84
5000	0.03	0.02	-0.27	-0.6	-0.58	-0.79	-0.68	-0.72
5500	0.03	-0.07	-0.21	-0.34	-0.06	-0.67	-0.39	-0.1
6000	0.02	-0.43	-0.45	-0.22	0.31	-0.62	-0.26	0.18

Notes

- A. Performance and quality attributes and conditions not expressly stated in this specification document are intended to be excluded and do not form a part of this specification document.
- B. Electrical specifications and performance data contained in this specification document are based on Mini-Circuit's applicable established test performance criteria and measurement instructions.
- C. The parts covered by this specification document are subject to Mini-Circuits standard limited warranty and terms and conditions (collectively, "Standard Terms"). Purchasers of this part are entitled to the rights and benefits contained therein. For a full statement of the Standard Terms and the exclusive rights and remedies thereunder, please visit Mini-Circuits' website at www.minicircuits.com/MCLStore/terms.jsp



Programmable Attenuator

RUDAT-4000-120

Typical Performance Data @ 50°C

FREQUENCY (MHz)	IP3 (dBm)	Insertion Loss @P _{IN} =0 dBm (dB)	Insertion Loss @P _{IN} =+20 dBm (dB)
1	49.76	4.56	4.38
5	53.52	4.61	4.42
10	54.31	4.69	4.49
20	56.56	4.76	4.56
50	48.03	4.37	4.26
100	47.44	5.32	5.19
200	50.13	5.53	5.39
500	57.53	6.16	6.02
750	54.95	6.54	6.41
1000	50.47	6.72	6.59
1500	52.31	7.24	7.11
2000	54.74	7.69	7.55
2500	53.53	8.15	7.99
3000	57.14	8.72	8.57
3500	49.21	9.19	9.04
4000	45.85	9.72	9.57
4500	45.54	9.39	9.19
5000	48.04	9.51	9.33
5500	44.67	9.95	9.78
6000	46.43	10.22	10.04

Notes

- A. Performance and quality attributes and conditions not expressly stated in this specification document are intended to be excluded and do not form a part of this specification document.
B. Electrical specifications and performance data contained in this specification document are based on Mini-Circuit's applicable established test performance criteria and measurement instructions.
C. The parts covered by this specification document are subject to Mini-Circuits standard limited warranty and terms and conditions (collectively, "Standard Terms"). Purchasers of this part are entitled to the rights and benefits contained therein. For a full statement of the Standard Terms and the exclusive rights and remedies thereunder, please visit Mini-Circuits' website at www.minicircuits.com/MCLStore/terms.jsp



Programmable Attenuator

RUDAT-4000-120

Typical Performance Curves @ 0°C

Attenuation Accuracy vs. Frequency over Attenuation settings

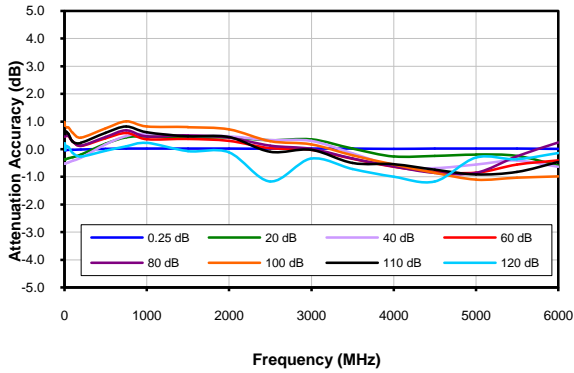

Attenuation relative to I.L. vs. Frequency over Attenuation settings

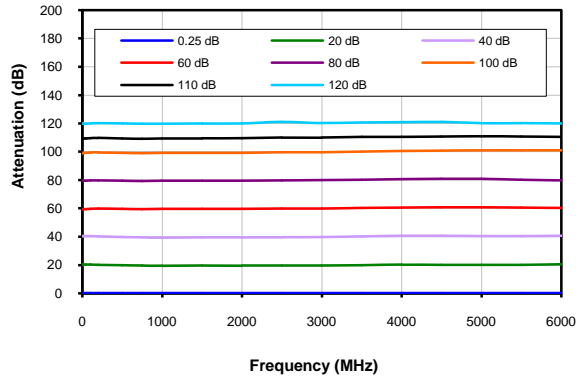

IP3 @ 0dB Attenuation

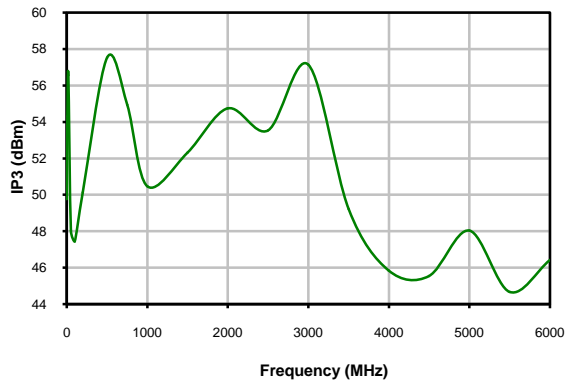

Insertion Loss

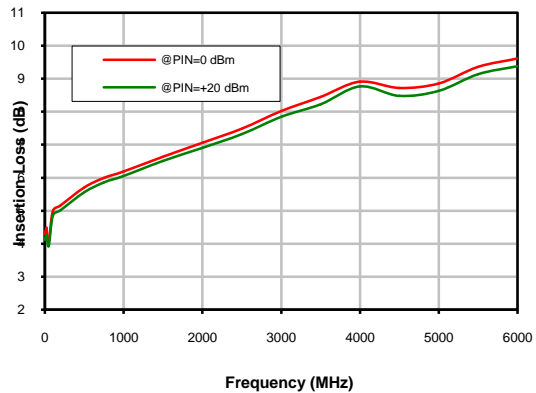

Notes

- A. Performance and quality attributes and conditions not expressly stated in this specification document are intended to be excluded and do not form a part of this specification document.
- B. Electrical specifications and performance data contained in this specification document are based on Mini-Circuit's applicable established test performance criteria and measurement instructions.
- C. The parts covered by this specification document are subject to Mini-Circuits standard limited warranty and terms and conditions (collectively, "Standard Terms"); Purchasers of this part are entitled to the rights and benefits contained therein. For a full statement of the Standard Terms and the exclusive rights and remedies thereunder, please visit Mini-Circuits' website at www.minicircuits.com/MCLStore/terms.jsp



Programmable Attenuator

RUDAT-4000-120

Typical Performance Curves @ +25°C

Attenuation Accuracy vs. Frequency over Attenuation settings

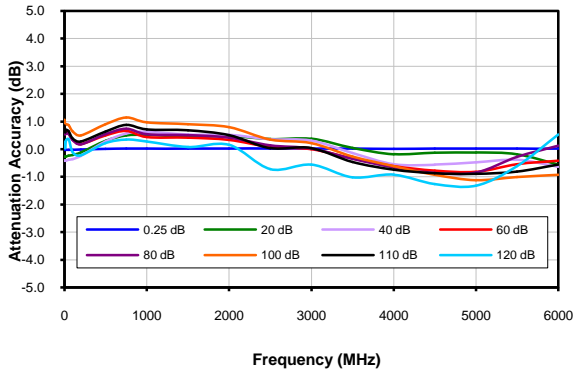

Attenuation relative to I.L. vs. Frequency over Attenuation settings

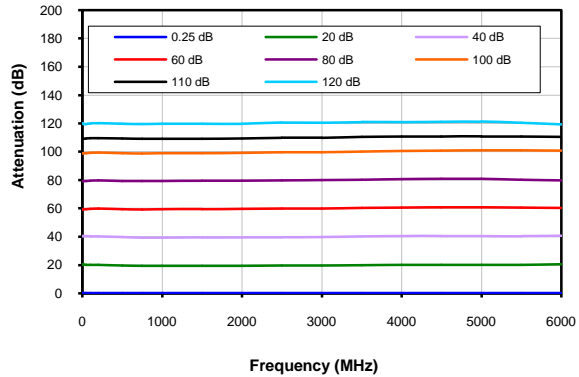

Input VSWR vs. Frequency over Attenuation settings

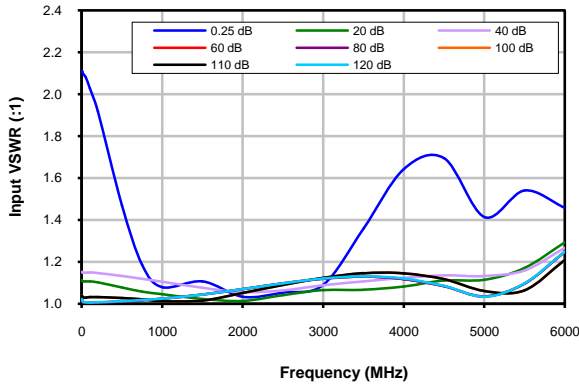

Output VSWR vs. Frequency over Attenuation settings

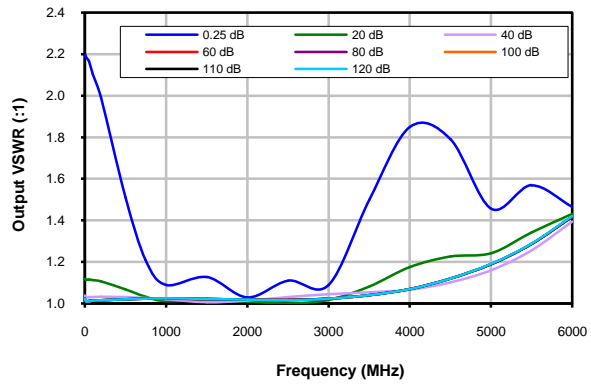

IP3 @ 0dB Attenuation

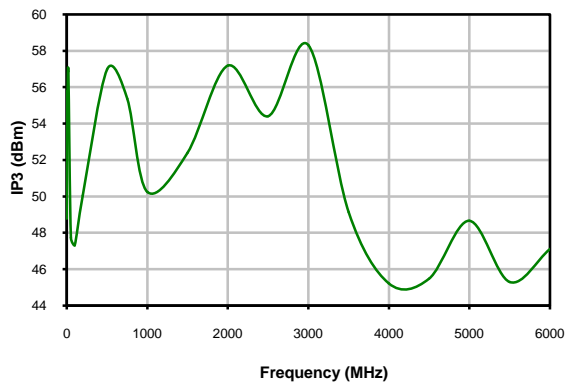

Insertion Loss

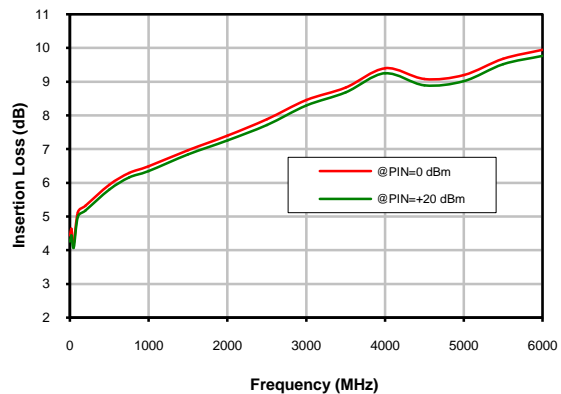

Notes

- A. Performance and quality attributes and conditions not expressly stated in this specification document are intended to be excluded and do not form a part of this specification document.
- B. Electrical specifications and performance data contained in this specification document are based on Mini-Circuit's applicable established test performance criteria and measurement instructions.
- C. The parts covered by this specification document are subject to Mini-Circuit's standard limited warranty and terms and conditions (collectively, "Standard Terms"); Purchasers of this part are entitled to the rights and benefits contained therein. For a full statement of the Standard Terms and the exclusive rights and remedies thereunder, please visit Mini-Circuit's website at www.minicircuits.com/MCLStore/terms.jsp



Programmable Attenuator

RUDAT-4000-120

Typical Performance Curves @ 50°C

Attenuation Accuracy vs. Frequency over Attenuation settings

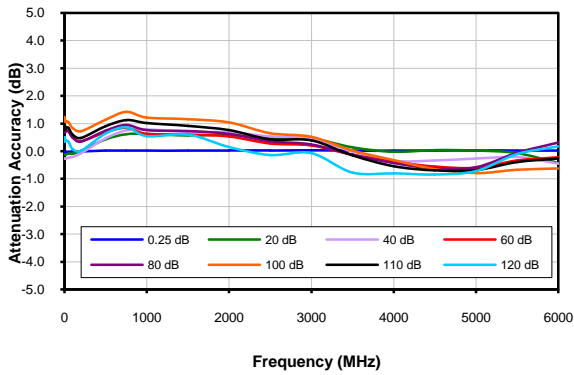

Attenuation relative to I.L. vs. Frequency over Attenuation settings

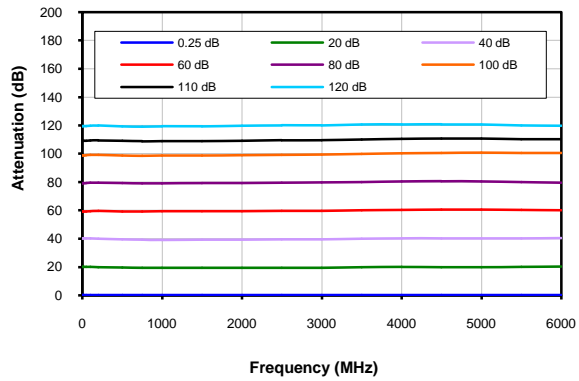

IP3 @ 0dB Attenuation

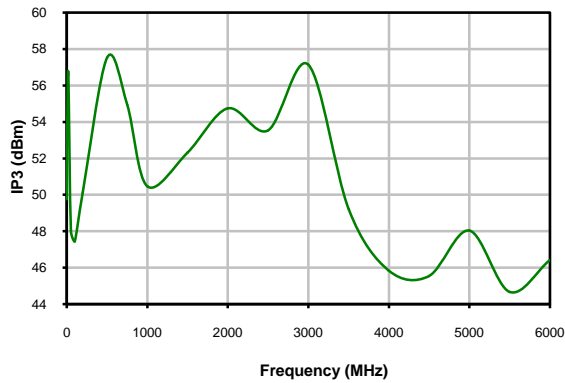

Insertion Loss

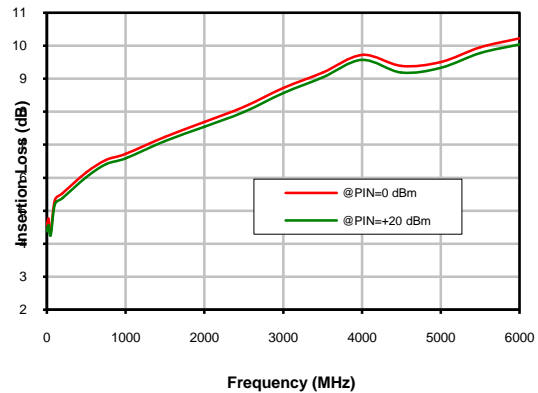

Notes

- A. Performance and quality attributes and conditions not expressly stated in this specification document are intended to be excluded and do not form a part of this specification document.
- B. Electrical specifications and performance data contained in this specification document are based on Mini-Circuit's applicable established test performance criteria and measurement instructions.
- C. The parts covered by this specification document are subject to Mini-Circuits standard limited warranty and terms and conditions (collectively, "Standard Terms"); Purchasers of this part are entitled to the rights and benefits contained therein. For a full statement of the Standard Terms and the exclusive rights and remedies thereunder, please visit Mini-Circuits' website at www.minicircuits.com/MCLStore/terms.jsp



Outline Dimensions

MS1813

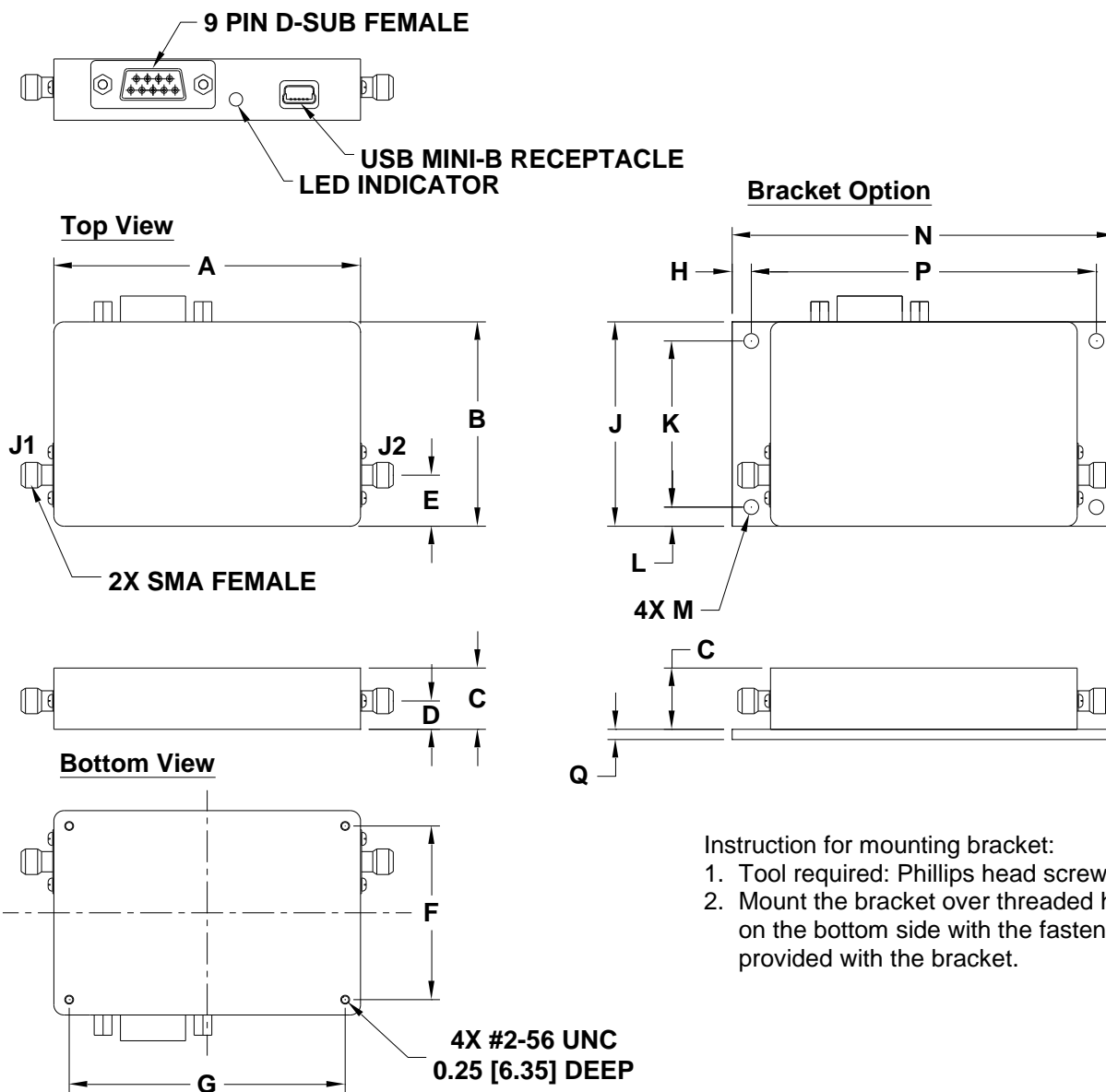

- Instruction for mounting bracket:
1. Tool required: Phillips head screwdriver
 2. Mount the bracket over threaded holes on the bottom side with the fasteners provided with the bracket.

CASE#	A	B	C	D	E	F	G	H	J	K	L	M	N	P	Q	WT. GRAMS
MS1813	3.00 (76.2)	2.00 (50.8)	.60 (15.2)	.28 (7.1)	.50 (12.7)	1.700 (43.18)	2.700 (68.58)	.188 (4.76)	2.00 (50.8)	1.625 (41.28)	.188 (4.76)	.144 (3.66)	3.75 (95.3)	3.375 (85.72)	.100 (2.54)	130

Dimensions are in inches (mm). Tolerances: 2PL. +/- .03; 3PL. +/- .015

Notes:

1. Case material: Nickel Plated Aluminum.



P.O. Box 350166, Brooklyn, New York 11235-0003 (718) 934-4500 Fax (718) 332-4661 For detailed performance specs & shopping online see Mini-Circuits web site



The Design Engineers Search Engine Provides ACTUAL Data Instantly From MINI-CIRCUITS At: www.minicircuits.com

RF/IF MICROWAVE COMPONENTS



Environmental Specifications **ENV55T1**

All Mini-Circuits products are manufactured under exacting quality assurance and control standards, and are capable of meeting published specifications after being subjected to any or all of the following physical and environmental test.

Specification	Test/Inspection Condition	Reference/Spec
Operating Temperature	-0° to 50° C Ambient Environment	Individual Model Data Sheet
Storage Temperature	-20° to 85° C Ambient Environment	Individual Model Data Sheet
Operating and Storage Humidity	5% to 85% RH (non-condensing)	Ambient
Bench Handling Test	Bench Top Tip 45° & Drop	MIL-PRF-28800F
Transit Drop Test	Free Fall Drop, 20 cm (7.9 inches)	MIL-PRF-28800F Class 3