

Voltage Controlled Oscillator ROS-933C-119+

50Ω 933 MHz

The Big Deal:

- Good Harmonic Suppression
- Low Phase Noise
- Robust design and construction
- Small size .500" x .500" x .220"



CASE STYLE: CK1113

Product Overview:

The ROS-933C-119+ is a Voltage Controlled Oscillator, designed to operate at 933 MHz for military applications. The ROS-933C-119+ is packaged in a metal case (size of .500" x .500" x .220") to shield against unwanted signals and noise.

Key Features

Feature	Advantages
Good Harmonic Suppression, -23dBc typ.	Provides clear signals suitable for systems requiring high spectral purity.
Low Phase Noise: -123dBc/Hz typ at 10kHz offset	Low phase noise improves system EVM (Error Vector Magnitude).
Good Pulling, 0.1MHz typ.	Improves immunity against changes in output load.
Good Pushing, 0.05MHz/V typ.	Provides increased immunity against noisy DC lines and improves output frequency stability vs. variations in supply voltage.
Robust design and construction	Each internal component of the ROS-933C-119+ is bonded to the substrate, providing better immunity to microphonics, reduced phase hit, and decreased tombstoning risk during subsequent reflow operations.
Small size, .500" x .500" x .220"	The small size enables the ROS-933C-119+ to be used in compact designs.

Voltage Controlled Oscillator

ROS-933C-119+

Linear Tuning 933 MHz

Features

- low phase noise, -123 dBc/Hz typ. @ 10kHz offset
- low pulling, 0.1 MHz typ.
- low pushing, 0.05 MHz/V typ.
- aqueous washable



CASE STYLE: CK1113

Applications

- wireless communications
- military

+RoHS Compliant
The +Suffix identifies RoHS Compliance. See our web site for RoHS Compliance methodologies and qualifications

Electrical Specifications

MODEL NO.	FREQ. (MHz)		POWER OUTPUT (dBm)	PHASE NOISE dBc/Hz SSB at offset frequencies, kHz				TUNING					NON HARMONIC SPURIOUS (dBc)		HARMONICS (dBc)		PULLING pk-pk @12 dB (MHz)	PUSHING (MHz/V)	DC OPERATING POWER		
	Min.	Max.		Typ.	1	10	100	1000	VOLTAGE RANGE (V)		SENSITIVITY (MHz/V)	PORT CAP (pF)	3 dB MODULATION BANDWIDTH (MHz)	Typ.	Typ.	Typ.			Max.	Vcc	Current (mA)
									Min.	Max.											
ROS-933C-119+	933		0	-97	-123	-144	-163	0.5	4.5	3.8	85	10	-90	-23	-14	0.1	0.05	5	35		

Pin Connections

RF OUT	10
VCC	14
V-TUNE	2
GROUND	1,3,4,5,6,7,8,9,11,12,13,15,16

Maximum Ratings

Operating Temperature	-40°C to 85°C
Storage Temperature	-55°C to 100°C
Absolute Max. Supply Voltage (Vcc)	7V
Absolute Max. Tuning Voltage (Vtune)	7V
All specifications	50 ohm system

Permanent damage may occur if any of these limits are exceeded.

Tape & Reel: F37

7" Reels with 10, 20, 50, 100 devices
13" Reels with 200, 500 devices

Environmental Ratings: ENV65T2

Outline Drawing

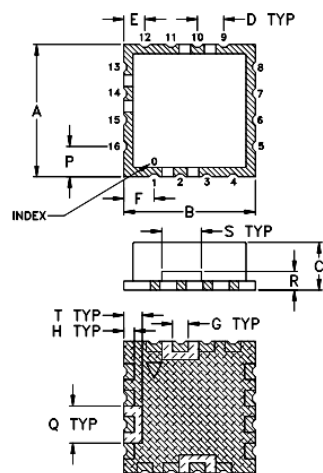

PCB Land Pattern

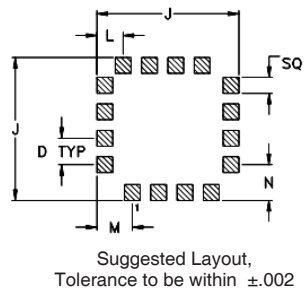

METALLIZATION
 SOLDER RESIST

Demo Board MCL P/N: TB-10 Suggested PCB Layout (PL-012)

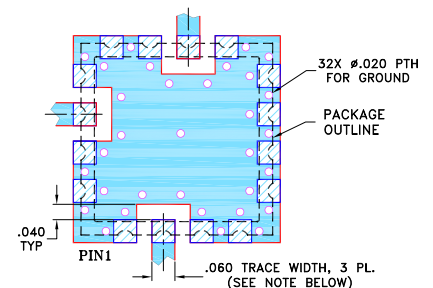

NOTES:

1. TRACE WIDTH IS SHOWN FOR FR4 WITH DIELECTRIC THICKNESS .030" ± .002"; COPPER: 1/2 OZ. EACH SIDE. FOR OTHER MATERIALS TRACE WIDTH MAY NEED TO BE MODIFIED.
 2. BOTTOM SIDE OF THE BOTTOM IS CONTINUOUS GROUND PLANE.
- DENOTES PCB COPPER LAYOUT WITH SMOBC (SOLDER MASK OVER BARE COPPER)
 DENOTES COPPER LAND PATTERN FREE OF SOLDER MASK

Outline Dimensions (inch/mm)

A	B	C	D	E	F	G	H	J	K	L	M	N	P	Q	R	S	T	wt.
.500	.500	.220	.100	.080	.115	.060	.040	.540	.060	.100	.135	.135	.115	.140	.070	.150	.070	grams
12.70	12.70	5.59	2.54	2.03	2.92	1.52	1.02	13.72	1.52	2.54	3.43	3.43	2.92	3.56	1.78	3.81	1.78	1.2

V TUNE	TUNE SENS (MHz/V)	FREQUENCY (MHz)			POWER OUTPUT (dBm)			I _{cc} (mA)	HARMONICS (dBc)			FREQ. PUSH (MHz/V)	FREQ. PULL (MHz)	PHASE NOISE (dBc/Hz) at offsets				FREQ OFFSET (kHz)	PHASE NOISE at 933 MHz (dBc/Hz)
		-40°C	+25°C	+85°C	-40°C	+25°C	+85°C		F2	F3	F4			1kHz	10kHz	100kHz	1MHz		
0.00	5.94	925.1	922.9	921.4	0.58	0.10	-0.47	27.35	-24.9	-44.8	-64.5	0.14	0.10	-95.34	-122.4	-143.7	-161.0	1.0	-96.92
0.50	4.72	927.8	925.7	924.3	0.59	0.13	-0.44	27.43	-24.7	-44.8	-65.9	0.07	0.09	-96.75	-122.9	-143.2	-161.2	2.1	-105.96
0.75	4.42	929.0	926.9	925.5	0.60	0.13	-0.44	27.45	-24.7	-45.5	-65.6	0.05	0.09	-98.97	-122.9	-144.2	-161.1	3.5	-112.48
1.00	4.21	930.1	928.0	926.6	0.60	0.14	-0.43	27.48	-24.6	-45.5	-64.3	0.04	0.09	-98.03	-123.4	-144.7	-162.1	6.1	-118.23
1.25	4.06	931.1	929.0	927.7	0.60	0.14	-0.42	27.51	-24.5	-46.0	-64.8	0.03	0.09	-97.49	-123.4	-144.7	-161.4	8.6	-122.23
1.50	3.95	932.1	930.0	928.7	0.61	0.15	-0.42	27.53	-24.4	-46.2	-66.3	0.03	0.09	-96.48	-123.6	-144.5	-161.3	10.0	-123.77
1.75	3.88	933.1	931.0	929.7	0.61	0.16	-0.42	27.56	-24.3	-46.7	-63.8	0.02	0.08	-98.10	-123.2	-144.1	-161.3	21.1	-131.10
2.00	3.82	934.1	932.0	930.7	0.61	0.16	-0.41	27.58	-24.3	-47.4	-66.8	0.02	0.08	-97.76	-123.3	-145.1	-161.2	36.0	-136.07
2.25	3.79	935.0	932.9	931.6	0.61	0.17	-0.40	27.60	-24.2	-47.9	-63.8	0.01	0.08	-97.17	-123.9	-144.3	-161.0	61.5	-140.91
2.50	3.76	936.0	933.9	932.6	0.62	0.17	-0.40	27.62	-24.1	-48.0	-66.5	0.01	0.08	-97.50	-123.6	-144.9	-161.0	87.9	-144.18
2.75	3.75	936.9	934.8	933.5	0.62	0.18	-0.40	27.63	-24.1	-48.5	-66.2	0.01	0.08	-98.48	-124.2	-145.1	-161.5	100.0	-145.40
3.00	3.75	937.9	935.8	934.5	0.62	0.18	-0.39	27.65	-24.0	-49.7	-63.5	0.00	0.08	-96.17	-124.2	-145.2	-162.8	150.2	-148.72
3.25	3.76	938.8	936.7	935.4	0.62	0.19	-0.39	27.68	-23.9	-50.9	-66.1	0.00	0.08	-96.20	-124.1	-145.0	-161.6	179.5	-150.30
3.50	3.78	939.8	937.7	936.3	0.62	0.20	-0.38	27.69	-23.8	-50.6	-66.4	0.00	0.08	-96.73	-124.0	-144.9	-161.7	214.6	-151.51
3.75	3.80	940.7	938.6	937.3	0.62	0.20	-0.38	27.71	-23.7	-52.1	-66.2	0.01	0.08	-97.40	-124.1	-145.5	-162.8	306.6	-154.98
4.00	3.83	941.7	939.6	938.2	0.62	0.21	-0.38	27.72	-23.8	-53.6	-66.8	0.01	0.07	-97.93	-124.0	-146.3	-164.1	360.0	-156.01
4.25	3.86	942.7	940.5	939.2	0.62	0.21	-0.37	27.74	-23.7	-54.0	-65.1	0.02	0.07	-97.29	-125.1	-145.6	-161.4	505.3	-160.30
4.50	3.89	943.6	941.5	940.1	0.62	0.22	-0.37	27.76	-23.6	-53.9	-64.8	0.03	0.07	-97.66	-123.7	-145.3	-161.7	604.0	-160.29
4.75	3.93	944.6	942.4	941.1	0.61	0.22	-0.37	27.76	-23.5	-51.9	-64.4	0.03	0.07	-97.24	-124.4	-145.8	-162.4	995.5	-163.76
5.00	3.96	945.6	943.4	942.1	0.61	0.22	-0.37	27.77	-23.3	-50.8	-62.3	0.04	0.07	-98.50	-124.7	-146.2	-162.6	1000.0	-163.82

*at 25°C unless mentioned otherwise

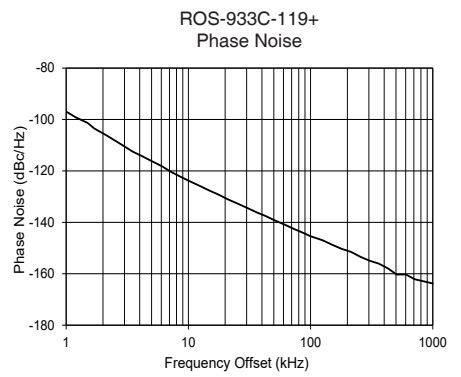
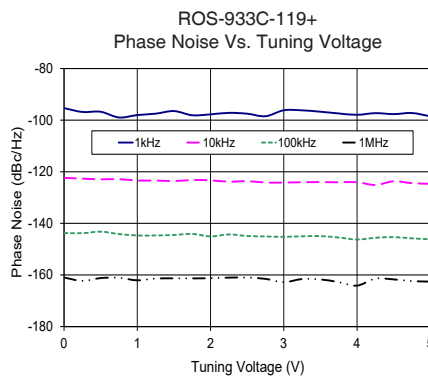
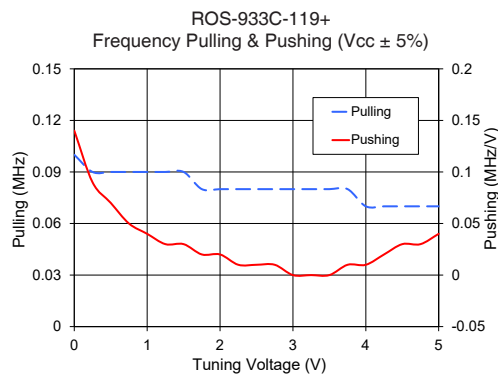
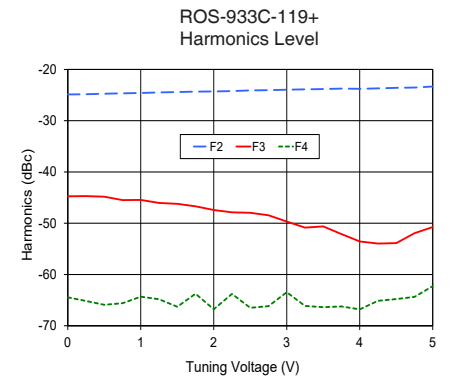
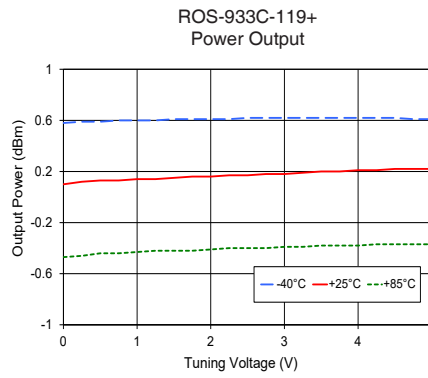
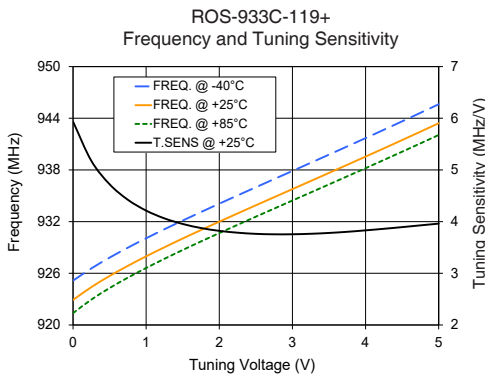

Additional Notes

- Performance and quality attributes and conditions not expressly stated in this specification document are intended to be excluded and do not form a part of this specification document.
- Electrical specifications and performance data contained in this specification document are based on Mini-Circuit's applicable established test performance criteria and measurement instructions.
- The parts covered by this specification document are subject to Mini-Circuits standard limited warranty and terms and conditions (collectively, "Standard Terms"); Purchasers of this part are entitled to the rights and benefits contained therein. For a full statement of the Standard Terms and the exclusive rights and remedies thereunder, please visit Mini-Circuits' website at www.minicircuits.com/MCLStore/terms.jsp

Voltage Controlled Oscillator

ROS-933C-119+

Typical Performance Data

V TUNE	TUNE SENS (MHz/V)	FREQUENCY (MHz)			POWER OUTPUT (dBm)			HARMONICS (dBc)			FREQ. PUSH (MHz/V)	FREQ OFFSET (kHz)	PHASE NOISE (dBc/Hz)
		-40°C	+25°C	+85°C	-40°C	+25°C	+85°C	F2	F3	F4			
0.00	5.9	925.1	922.9	921.4	0.6	0.1	-0.5	-24.9	-44.8	-64.5	0.1	1	-97
0.25	5.2	926.6	924.4	922.9	0.6	0.1	-0.5	-24.8	-44.7	-65.2	0.1	10	-123
0.50	4.7	927.8	925.7	924.3	0.6	0.1	-0.4	-24.7	-44.8	-65.9	0.1	100	-144
0.75	4.4	929.0	926.9	925.5	0.6	0.1	-0.4	-24.7	-45.5	-65.6	0.1	1000	-163
1.00	4.2	930.1	928.0	926.6	0.6	0.1	-0.4	-24.6	-45.5	-64.3	0.0		
1.25	4.1	931.1	929.0	927.7	0.6	0.1	-0.4	-24.5	-46.0	-64.8	0.0		
1.50	4.0	932.1	930.0	928.7	0.6	0.2	-0.4	-24.4	-46.2	-66.3	0.0		
1.75	3.9	933.1	931.0	929.7	0.6	0.2	-0.4	-24.3	-46.7	-63.8	0.0		
2.00	3.8	934.1	932.0	930.7	0.6	0.2	-0.4	-24.3	-47.4	-66.8	0.0		
2.25	3.8	935.0	932.9	931.6	0.6	0.2	-0.4	-24.2	-47.9	-63.8	0.0		
2.50	3.8	936.0	933.9	932.6	0.6	0.2	-0.4	-24.1	-48.0	-66.5	0.0		
2.75	3.8	936.9	934.8	933.5	0.6	0.2	-0.4	-24.1	-48.5	-66.2	0.0		
3.00	3.8	937.9	935.8	934.5	0.6	0.2	-0.4	-24.0	-49.7	-63.5	0.0		
3.25	3.8	938.8	936.7	935.4	0.6	0.2	-0.4	-23.9	-50.9	-66.1	0.0		
3.50	3.8	939.8	937.7	936.3	0.6	0.2	-0.4	-23.8	-50.6	-66.4	0.0		
3.75	3.8	940.7	938.6	937.3	0.6	0.2	-0.4	-23.7	-52.1	-66.2	0.0		
4.00	3.8	941.7	939.6	938.2	0.6	0.2	-0.4	-23.8	-53.6	-66.8	0.0		
4.25	3.9	942.7	940.5	939.2	0.6	0.2	-0.4	-23.7	-54.0	-65.1	0.0		
4.50	3.9	943.6	941.5	940.1	0.6	0.2	-0.4	-23.6	-53.9	-64.8	0.0		
4.75	3.9	944.6	942.4	941.1	0.6	0.2	-0.4	-23.5	-51.9	-64.4	0.0		
5.00	4.0	945.6	943.4	942.1	0.6	0.2	-0.4	-23.3	-50.8	-62.3	0.0		
5.25	4.0	946.6	944.4	943.0	0.6	0.2	-0.4	-23.2	-48.9	-64.5	0.1		
5.50	4.0	947.6	945.4	944.0	0.6	0.2	-0.4	-23.1	-47.3	-60.4	0.1		
5.75	4.0	948.7	946.4	945.0	0.6	0.2	-0.4	-23.0	-47.0	-60.6	0.1		
6.00	4.1	949.7	947.4	946.0	0.6	0.2	-0.4	-22.8	-46.7	-59.6	0.1		
6.25	4.1	950.7	948.5	947.0	0.6	0.2	-0.4	-22.6	-46.4	-61.2	0.1		
6.50	4.1	951.8	949.5	948.1	0.5	0.2	-0.4	-22.4	-46.1	-61.0	0.1		
6.75	4.1	952.8	950.5	949.1	0.5	0.2	-0.4	-22.2	-45.1	-58.9	0.1		
7.00	4.1	953.9	951.5	950.1	0.5	0.2	-0.4	-22.2	-44.4	-60.2	0.1		

Notes

- A. Performance and quality attributes and conditions not expressly stated in this specification document are intended to be excluded and do not form a part of this specification document.
- B. Electrical specifications and performance data contained in this specification document are based on Mini-Circuits' applicable established test performance criteria and measurement instructions.
- C. The parts covered by this specification document are subject to Mini-Circuits' standard limited warranty and terms and conditions (collectively, "Standard Terms"); Purchasers of this part are entitled to the rights and benefits contained therein. For a full statement of the Standard Terms and the exclusive rights and remedies thereunder, please visit Mini-Circuits' website at www.minicircuits.com/MCULStoreTerms.jsp



Voltage Controlled Oscillator

ROS-933C-119+

Typical Performance Data

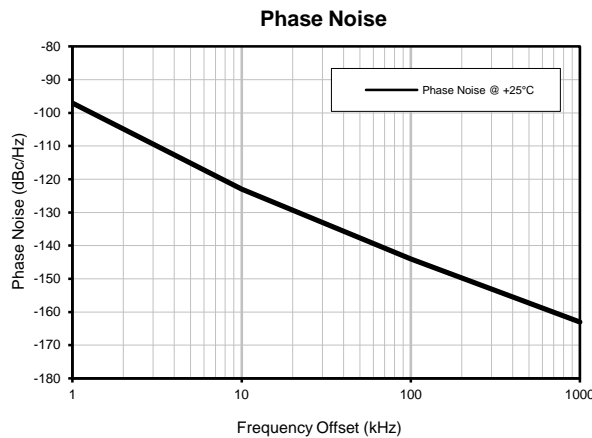
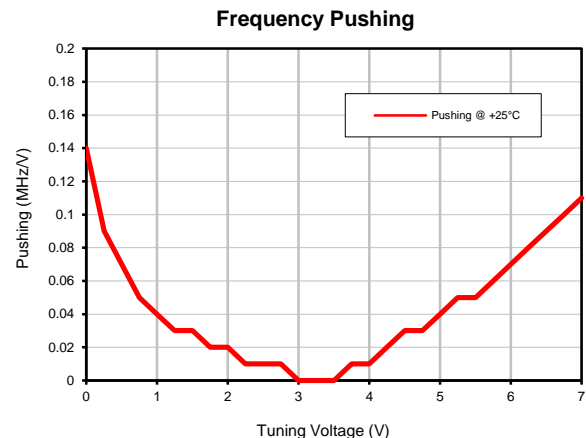
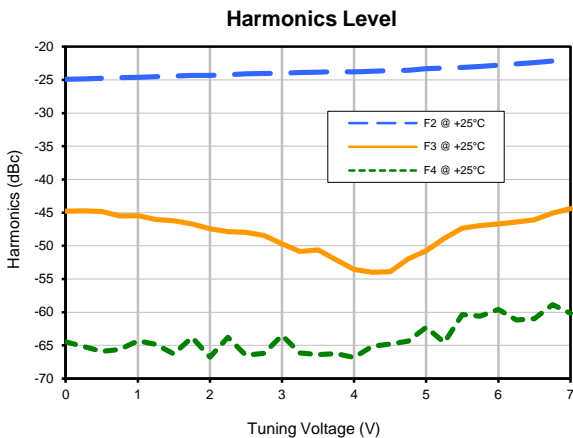
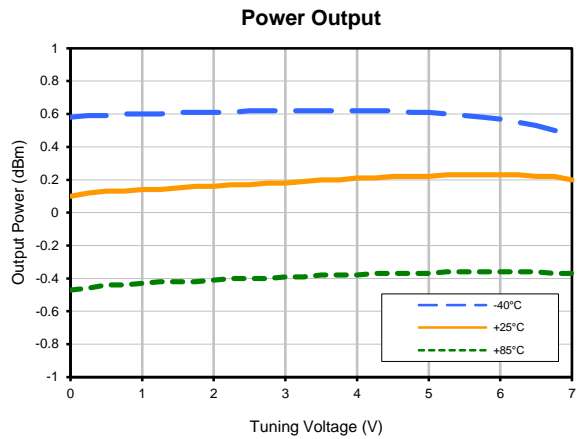
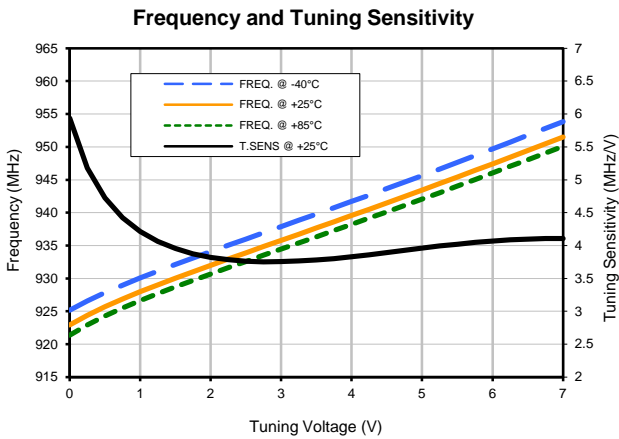

Notes

- A. Performance and quality attributes and conditions not expressly stated in this specification document are intended to be excluded and do not form a part of this specification document.
- B. Electrical specifications and performance data contained in this specification document are based on Mini-Circuits' applicable established test performance criteria and measurement instructions.
- C. The parts covered by this specification document are subject to Mini-Circuits standard limited warranty and terms and conditions (collectively, "Standard Terms"); Purchasers of this part are entitled to the rights and benefits contained therein. For a full statement of the Standard Terms and the exclusive rights and remedies thereunder, please visit Mini-Circuits' website at www.minicircuits.com/MCULStore/terms.jsp

CK1113

Outline Dimensions

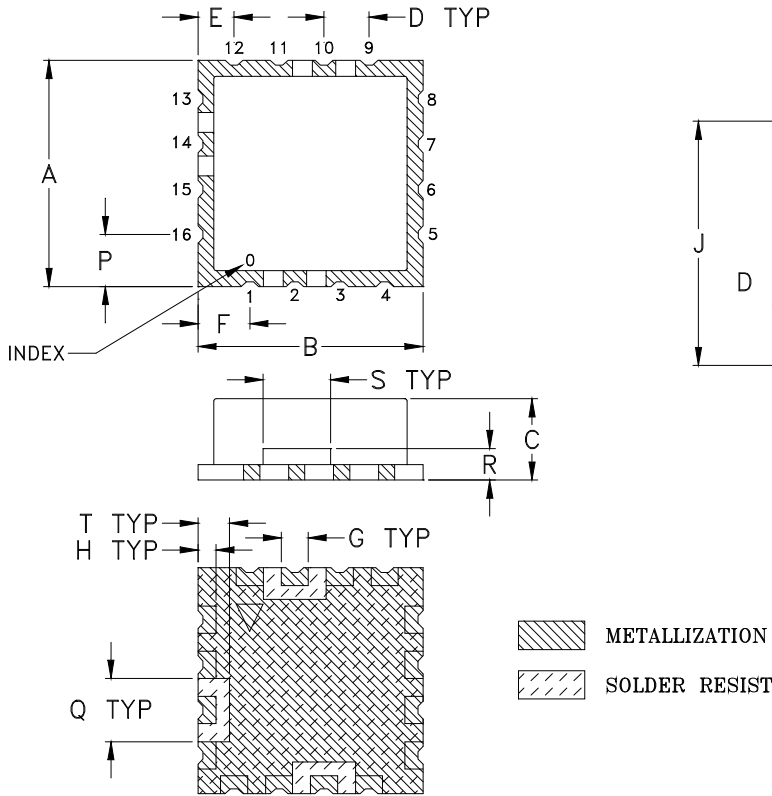

PCB Land Pattern

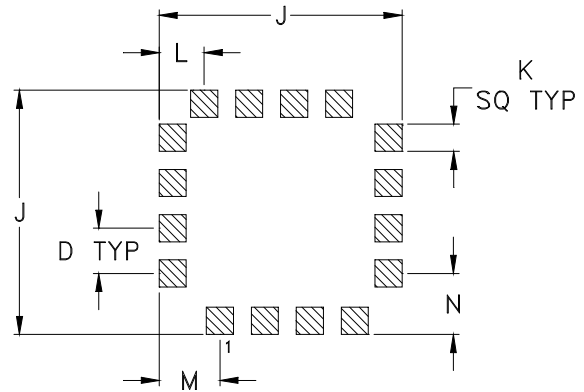

Suggested Layout,
Tolerance to be within ± 0.002

CASE #	A	B	C	D	E	F	G	H	J	K
CK1113	.500 (12.70)	.500 (12.70)	.220 (5.59)	.100 (2.54)	.080 (2.03)	.115 (2.92)	.060 (1.52)	.040 (1.02)	.540 (13.72)	.060 (1.52)

CASE #	L	M	N	P	Q	R	S	T	WT. GRAM
CK1113	.100 (2.54)	.135 (3.43)	.135 (3.43)	.115 (2.92)	.140 (3.56)	.070 (1.78)	.150 (3.81)	.070 (1.78)	1.2

Dimensions are in inches (mm). Tolerances: 2 Pl. $\pm .03$; 3Pl. $\pm .015$

Notes:

1. Case material: Nickel-Silver alloy.
2. Base: Printed wiring laminate.
3. Termination finish:

For RoHS Case Styles: 3-5 μ inch (.08-.13 microns) Gold over 120-240 μ inch (3.05-6.10 microns) Nickel plate.
All models, (+) suffix.

Mini-Circuits
ISO 9001 ISO 14001 CERTIFIED

ALL NEW
minicircuits.com

P.O. Box 350166, Brooklyn, New York 11235-0003 (718) 934-4500 Fax (718) 332-4661 For detailed performance specs & shopping online see Mini-Circuits web site



The Design Engineers Search Engine Provides ACTUAL Data Instantly From MINI-CIRCUITS At: www.minicircuits.com

RF/IF MICROWAVE COMPONENTS

Tape & Reel Packaging TR-F37



Tape Width, mm	Device Cavity Pitch, mm	Reel Size, inches	Devices per Reel	
24	16	7	Small quantity standards (see note)	10
				20
				50
				100
		13	Standard	200
				500

Note: Please consult individual model data sheet to determine device per reel availability.

Mini-Circuits carrier tape materials provide protection from ESD (Electro-Static Discharge) during handling and transportation. Tapes are static dissipative and comply with industry standards EIA-481/EIA-541.

Go to: www.minicircuits.com/pages/pdfs/tape.pdf



INTERNET <http://www.minicircuits.com>

P.O. Box 350166, Brooklyn, New York 11235-0003 (718) 934-4500 Fax (718) 332-4661

Distribution Centers NORTH AMERICA 800-654-7949 • 417-335-5935 • Fax 417-335-5945 • EUROPE 44-1252-832600 • Fax 44-1252-837010

Mini-Circuits ISO 9001 & ISO 14001 Certified

THIRD ANGLE PROJECTION

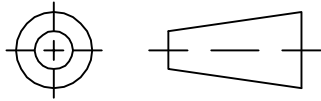

REVISIONS

REV	ECN No.	DESCRIPTION	DATE	DR	AUTH
E	M105563	ADDED "r1" PIN CONNECTION	06/02/06	MMG	DJ
F	M105640	CORRECTED NOTE 2	06/08/06	MMG	MM
G	M124395	ADDED "RAMP"	09/09	EM	HH
G	R77589	ADDED "RAMP"	09/09	EM	HH

SUGGESTED MOUNTING CONFIGURATION FOR CK605 CASE STYLE, "kg/rl/16AM01" PIN CONNECTION

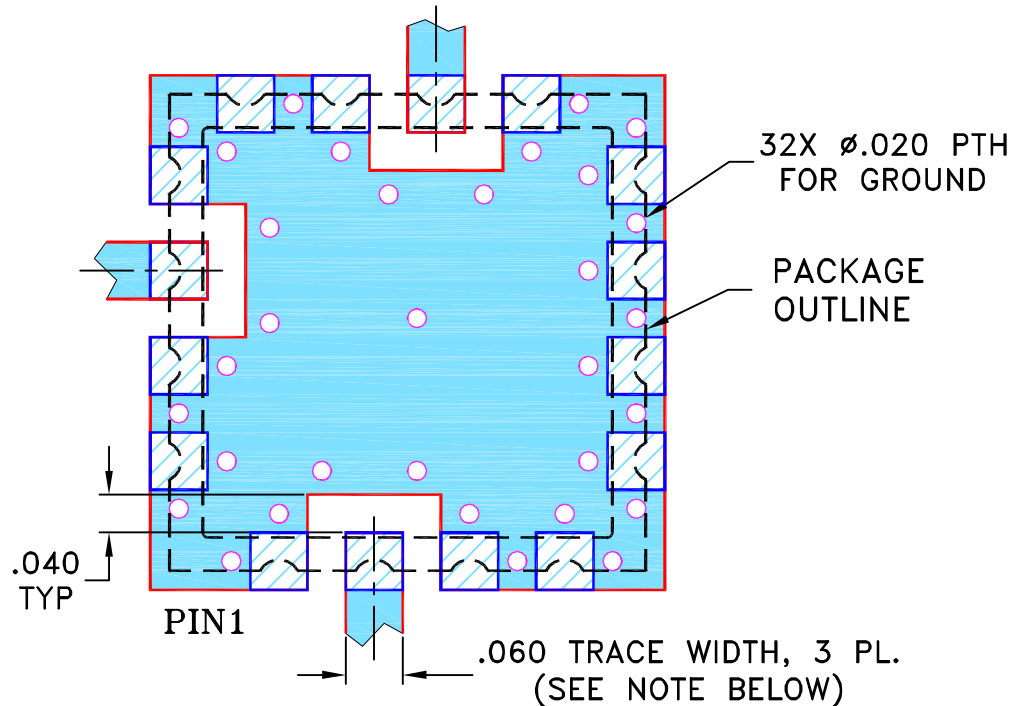

NOTES:

1. TRACE WIDTH IS SHOWN FOR FR4 WITH DIELECTRIC THICKNESS .030" ± .002"; COPPER: 1/2 OZ. EACH SIDE. FOR OTHER MATERIALS TRACE WIDTH MAY NEED TO BE MODIFIED.
2. BOTTOM SIDE OF THE BOTTOM IS CONTINUOUS GROUND PLANE.

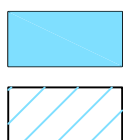

DENOTES PCB COPPER LAYOUT WITH SMOBC (SOLDER MASK OVER BARE COPPER)

DENOTES COPPER LAND PATTERN FREE OF SOLDER MASK

UNLESS OTHERWISE SPECIFIED	INITIALS	DATE
DIMENSIONS ARE IN INCHES	DRAWN AV	08/07/00
TOLERANCES ON:	CHECKED SK	08/08/00
2 PL DECIMALS ±	APPROVED DB	08/08/00
3 PL DECIMALS ± .005		
ANGLES ±		
FRACTIONS ±		

 **Mini-Circuits®** 13 Neptune Avenue
Brooklyn NY 11235

PL,kg/rl/16AM01,CK605,ROS/LAVI/RAMP

SIZE	CODE IDENT	DRAWING NO:	REV:
A	15542	98-PL-012	G
FILE:	98PL012	SCALE: 5:1	SHEET: 1 OF 1

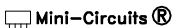
 Mini-Circuits®
THIS DOCUMENT AND ITS CONTENTS ARE THE PROPERTY OF MINI-CIRCUITS. EXCEPT FOR USE EXPRESSLY GRANTED, IN WRITING, TO ITS VENDORS, VENDEE AND THE UNITED STATES GOVERNMENT, MINI-CIRCUITS RESERVES ALL PROPRIETARY DESIGN, USE, MANUFACTURING AND REPRODUCTION RIGHTS THERETO. THESE CONTENTS SHALL NOT BE USED, DUPLICATED OR DISCLOSED TO ANY OUTSIDE PARTY, IN WHOLE OR IN PART, WITHOUT WRITTEN PERMISSION OF MINI-CIRCUITS.

Evaluation Board and Circuit



Schematic Diagram

Notes:

1. SMA Female connectors.
2. PCB Material: Rogers R04350 or equivalent, Dielectric Constant=3.5, Thickness=.030 inch.

 **Mini-Circuits®**



All Mini-Circuits products are manufactured under exacting quality assurance and control standards, and are capable of meeting published specifications after being subjected to any or all of the following physical and environmental test.

Specification	Test/Inspection Condition	Reference/Spec
Operating Temperature	-40° to 85°C Ambient Environment	Individual Model Data Sheet
Storage Temperature	-55° to 100° C Ambient Environment	Individual Model Data Sheet
Humidity	90 to 95% RH, 240 hours, 50°C	MIL-STD-202, Method 103, Condition A, Except 50°C and end-point electrical test done within 12 hours
Thermal Shock	-55° to 100°C, 100 cycles	MIL-STD-202, Method 107, Condition A-3, except +100°C
Solder Reflow Heat	Sn-Pb Eutectic Process: 225°C peak Pb-Free Process, 245°C peak	J-STD-020, Table 4-1, 4-2 and 5-2, Figure 5-1
Solderability	10X Magnification	J-STD-002, Para 4.2.5, Test S, 95% Coverage
Vibration (High Frequency)	20g peak, 20-2000 Hz, 4 times in each of three axes (total 12)	MIL-STD-883, Method 2007.3, Condition A
Mechanical Shock	50g, 11 ms, 1/2-sine, 18 shocks: 3 each direction, each of 3 axes	MIL-STD-202, Method 213, Condition A
Marking Resistance to Solvents	Isopropyl alcohol + mineral spirits at 25°C; terpene defluxer at 25°C; distilled water + proylene glycol monomethyl ether + monoethanolamine at 63°C to 70°C	MIL-STD-202, Method 215