

# Surface Mount Voltage Controlled Oscillator

## ROS-2500+

Wide Band 1600 to 2500 MHz



CASE STYLE: CK605

### Features

- wideband, 1600 to 2500 MHz
- low phase noise, -133 dBc/Hz at 1 MHz offset, typ.
- aqueous washable

### Applications

- PCS

**+RoHS Compliant**  
The +Suffix identifies RoHS Compliance. See our web site for RoHS Compliance methodologies and qualifications

### Electrical Specifications

FREQUENCY (MHz)	POWER OUTPUT (dBm)	TUNING VOLTAGE (V)	PHASE NOISE (dBc/Hz)				PULLING pk-pk @ 12 dB (MHz)	PUSHING (MHz/V)	TUNING SENSITIVITY (MHz/V)	HARMONICS (dBc)	3 dB MODULATION BANDWIDTH (MHz)	DC OPERATING POWER	
			SSB at offset frequencies: Typ.									Vcc (volts)	Current (mA) Max.
Min. Max.	Typ.	Min. Max.	1 kHz	10 kHz	100 kHz	1 MHz	Typ.	Typ.	Typ.	Typ. Max.	Typ.		
1600 2500	6.5	0.5 14	-66	-90	-113	-133	18.0	5.0	30-180	-14 -8	6	12	25

### Pin Connections

RF OUT	10
VCC	14
V-TUNE	2
GROUND	1,3,4,5,6,7,8,9,11,12,13,15,16

Permanent damage may occur if any of these limits are exceeded.

### Maximum Ratings

Operating Temperature	-55°C to 85°C
Storage Temperature	-55°C to 100°C
Absolute Max. Supply Voltage (Vcc)	+15V
Absolute Max. Tuning Voltage (Vtune)	+16V

all specifications: 50 ohm system  
Permanent damage may occur if any of these limits are exceeded.

### Outline Drawing

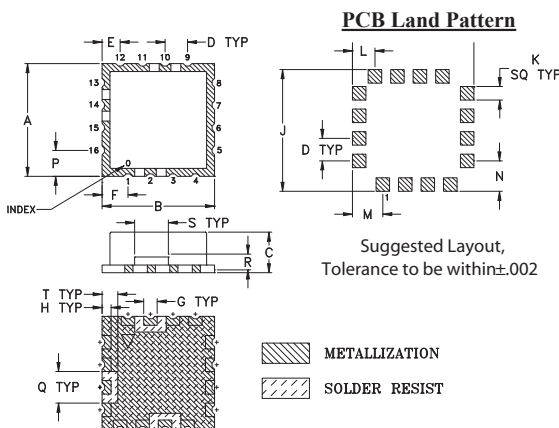

### Demo Board MCL P/N: TB-10 Suggested PCB Layout (PL-012)

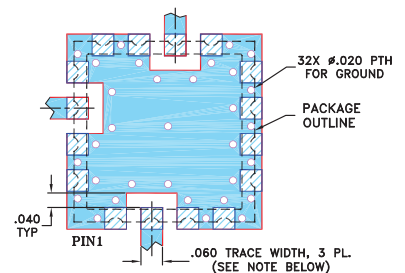

- NOTES: 1. TRACE WIDTH IS SHOWN FOR FR4 WITH DIELECTRIC THICKNESS .030" ± .002"; COPPER: 1/2 OZ. EACH SIDE. FOR OTHER MATERIALS TRACE WIDTH MAY NEED TO BE MODIFIED.  
2. BOTTOM SIDE OF THE PCB IS CONTINUOUS GROUND PLANE.
- DENOTES PCB COPPER LAYOUT WITH SMOBC (SOLDER MASK OVER BARE COPPER)
  - DENOTES COPPER LAND PATTERN FREE OF SOLDER MASK

### Outline Dimensions (inch)

A	B	C	D	E	F	G	H	J	K	L	M	N	P	Q	R	S	T	wt.
.500	.500	.180	.100	.080	.115	.060	.040	.540	.060	.100	.135	.135	.115	.140	.070	.150	.070	grams
12.70	12.70	4.57	2.54	2.03	2.92	1.52	1.02	13.72	1.52	2.54	3.43	3.43	2.92	3.56	1.78	3.81	1.78	1.0

### Notes

- A. Performance and quality attributes and conditions not expressly stated in this specification document are intended to be excluded and do not form a part of this specification document.  
B. Electrical specifications and performance data contained in this specification document are based on Mini-Circuit's applicable established test performance criteria and measurement instructions.  
C. The parts covered by this specification document are subject to Mini-Circuits standard limited warranty and terms and conditions (collectively, "Standard Terms"); Purchasers of this part are entitled to the rights and benefits contained therein. For a full statement of the Standard Terms and the exclusive rights and remedies thereunder, please visit Mini-Circuits' website at [www.minicircuits.com/MCLStore/terms.jsp](http://www.minicircuits.com/MCLStore/terms.jsp)



[www.minicircuits.com](http://www.minicircuits.com) P.O. Box 350166, Brooklyn, NY 11235-0003 (718) 934-4500 sales@minicircuits.com

REV. G  
M151108  
ED-7473B/3  
ROS-2500+  
RAV/MCL  
151105  
Page 1 of 2

# Performance Data & Curves

# ROS-2500+

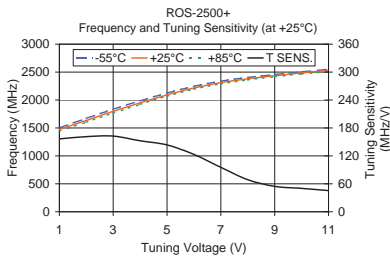

V TUNE	TUNING SENS. (MHz/V)	FREQUENCY (MHz)			POWER OUTPUT (dBm)		
		-55°C	+25°C	+85°C	-55°C	+25°C	+85°C
1.00	156.40	1501.52	1473.06	1445.18	5.70	5.77	5.28
2.00	161.35	1671.28	1634.41	1603.80	6.20	5.99	5.34
3.00	162.52	1835.76	1796.93	1766.70	7.04	6.66	5.86
4.00	152.45	1986.50	1949.39	1922.75	7.48	7.06	6.23
5.00	143.59	2126.51	2092.98	2068.65	7.57	7.15	6.29
6.00	123.11	2245.23	2216.09	2194.09	7.53	7.06	6.28
7.00	95.41	2338.10	2311.50	2290.61	7.76	7.08	6.31
8.00	68.87	2405.31	2380.37	2360.90	7.98	7.24	6.44
9.00	54.46	2455.83	2434.83	2417.91	7.94	7.18	6.27
10.00	50.25	2504.20	2485.08	2467.35	7.45	6.74	5.88
11.00	45.50	2551.88	2530.58	2511.16	6.99	6.44	5.60

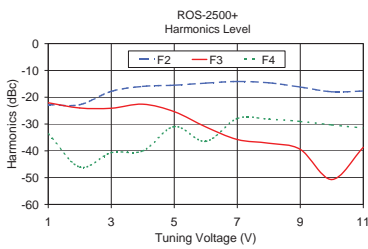
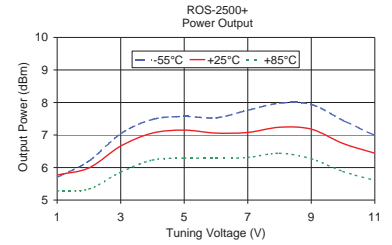

V TUNE	HARMONICS (dBc)			FREQ. PUSHING (MHz/V)
	F2	F3	F4	
1.00	-22.77	-22.05	-33.59	0.08
2.00	-22.77	-24.00	-46.07	0.19
3.00	-17.81	-24.11	-40.65	1.14
4.00	-15.93	-22.59	-40.02	2.78
5.00	-15.51	-25.38	-30.92	3.63
6.00	-14.73	-31.08	-36.45	4.26
7.00	-14.11	-35.78	-27.91	3.83
8.00	-14.60	-37.16	-28.17	2.58
9.00	-16.19	-39.47	-29.03	1.47
10.00	-17.95	-50.70	-30.33	0.79
11.00	-17.67	-38.68	-31.47	0.52

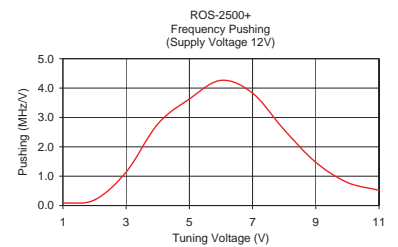

### Notes

- A. Performance and quality attributes and conditions not expressly stated in this specification document are intended to be excluded and do not form a part of this specification document.
- B. Electrical specifications and performance data contained in this specification document are based on Mini-Circuit's applicable established test performance criteria and measurement instructions.
- C. The parts covered by this specification document are subject to Mini-Circuits standard limited warranty and terms and conditions (collectively, "Standard Terms"); Purchasers of this part are entitled to the rights and benefits contained therein. For a full statement of the Standard Terms and the exclusive rights and remedies thereunder, please visit Mini-Circuits' website at [www.minicircuits.com/MCLStore/terms.jsp](http://www.minicircuits.com/MCLStore/terms.jsp)



# Voltage Controlled Oscillator

# ROS-2500+

## Typical Performance Data

V TUNE	TUNE SENS (MHz/V)	FREQUENCY (MHz)			POWER OUTPUT (dBm)			HARMONICS (dBc)			FREQ. PUSH (MHz/V)	FREQ OFFSET (KHz)	PHASE NOISE (dBc/Hz)
		-55°C	+25°C	+85°C	-55°C	+25°C	+85°C	F2	F3	F4			
0.0	43.50	1415.87	1392.10	1369.85	7.99	7.92	7.87	-13.49	-18.46	-26.00	0.63	1	-62
0.5	47.36	1440.88	1413.85	1392.60	7.82	7.80	7.80	-14.04	-18.43	-25.76	0.48	10	-89
1.0	48.94	1466.19	1437.53	1413.86	7.69	7.66	7.71	-14.86	-18.18	-27.02	0.37	100	-111
1.5	51.98	1490.94	1462.00	1438.66	7.62	7.53	7.50	-15.82	-18.25	-27.63	0.32	1000	-131
2.0	59.95	1516.27	1487.99	1465.43	7.53	7.41	7.32	-16.54	-19.51	-29.61	0.06		
2.5	78.00	1545.88	1517.97	1494.49	7.33	7.27	7.19	-17.71	-19.67	-33.27	0.07		
3.0	90.18	1584.19	1556.97	1527.28	7.16	7.07	6.94	-18.52	-22.10	-40.19	0.25		
3.5	96.61	1637.31	1602.05	1571.36	7.12	6.92	6.67	-20.25	-20.61	-45.80	0.02		
4.0	102.48	1692.37	1650.36	1616.75	7.24	6.98	6.45	-21.94	-20.28	-42.32	0.12		
4.5	107.68	1747.71	1701.60	1668.27	7.54	6.97	6.14	-23.00	-19.91	-43.27	0.17		
5.0	114.70	1804.98	1755.44	1723.71	7.76	7.07	6.08	-21.74	-19.64	-42.05	0.08		
5.5	117.92	1859.87	1812.79	1783.61	7.97	7.13	5.86	-19.59	-19.81	-39.11	0.20		
6.0	116.92	1920.96	1871.75	1844.18	8.40	7.24	5.88	-17.53	-20.05	-34.92	0.80		
6.5	114.91	1978.15	1930.21	1905.76	8.60	7.42	5.90	-16.32	-20.44	-34.50	1.38		
7.0	110.92	2030.68	1987.67	1965.47	8.85	7.57	6.02	-15.14	-22.46	-33.94	1.82		
7.5	106.91	2083.84	2043.13	2023.11	8.87	7.75	6.29	-13.97	-24.30	-32.62	2.57		
8.0	99.85	2132.19	2096.58	2079.12	9.08	7.92	6.47	-13.02	-25.97	-30.57	2.74		
8.5	97.04	2180.20	2146.51	2131.03	9.11	8.09	6.77	-12.35	-27.33	-28.65	3.01		
9.0	91.20	2225.03	2195.03	2181.94	9.25	8.17	7.00	-12.76	-29.62	-30.33	3.17		
9.5	90.28	2268.78	2240.63	2228.58	9.22	8.23	7.24	-13.36	-32.14	-32.01	3.20		
10.0	89.08	2311.58	2285.77	2275.46	9.24	8.08	7.17	-14.12	-33.53	-33.56	2.31		
10.5	87.69	2354.24	2330.31	2320.49	9.03	8.00	7.13	-15.88	-35.69	-36.92	2.02		
11.0	85.52	2392.95	2374.15	2363.47	8.97	7.84	7.06	-16.78	-40.25	-38.89	2.60		
11.5	82.46	2436.40	2416.91	2407.30	8.59	7.62	6.87	-16.89	-36.73	-38.65	1.86		
12.0	76.16	2480.56	2458.14	2445.86	8.31	7.46	6.81	-16.28	-34.03	-40.30	2.07		
12.5	70.69	2521.11	2496.21	2483.71	8.34	7.44	6.77	-15.54	-29.98	-42.80	2.24		
13.0	68.17	2558.58	2531.56	2519.41	8.24	7.47	6.87	-14.84	-27.77	-45.48	2.34		
13.5	64.19	2594.17	2565.64	2552.22	8.19	7.44	6.80	-14.63	-27.43	-46.79	2.63		
14.0	57.38	2627.33	2597.74	2584.46	8.24	7.37	6.81	-13.96	-28.07	-47.46	2.32		
14.5	55.52	2658.21	2626.43	2614.49	8.10	7.40	6.77	-13.50	-28.02	-49.01	2.16		
15.0	52.30	2687.26	2654.19	2641.36	8.28	7.46	6.82	-13.12	-27.95	-48.40	2.47		
15.5	48.98	2714.10	2680.34	2668.11	8.21	7.49	6.80	-13.45	-27.76	-48.19	2.30		
16.0	48.98	2737.49	2704.83	2692.55	8.58	7.48	6.88	-13.38	-27.67	-48.60	2.55		



ISO 9001 ISO 14001 AS 9100 CERTIFIED

For detailed performance specs & shopping online see web site

P.O. Box 350166, Brooklyn, New York 11235-0008 (718) 634-4500 Fax (718) 332-4661 The Design Engineers Search Engine Provides ACTUAL Data Instantly at [minicircuits.com](http://minicircuits.com)

MMIC MICROWAVE COMPONENTS

Notes: 1. Performance and quality attributes and conditions not expressly stated in this specification sheet are intended to be excluded and do not form a part of this specification sheet. 2. Electrical specifications and performance data contained herein are based on Mini-Circuits' applicable established test performance criteria and measurement instructions. 3. The parts covered by this specification sheet are subject to Mini-Circuits' standard limited warranty and terms and conditions (collectively, "Standard Terms"). Purcchase of this part entails acceptance of the rights and benefits contained therein. For a full statement of the Standard Terms and the exclusive rights and remedies thereunder, please visit Mini-Circuits' website at [www.minicircuits.com/MCI\\_Store/terms.jsp](http://www.minicircuits.com/MCI_Store/terms.jsp).

# Voltage Controlled Oscillator

# ROS-2500+

## Typical Performance Data

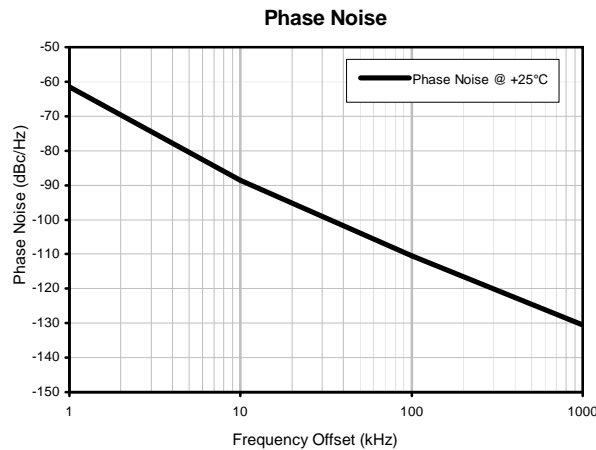
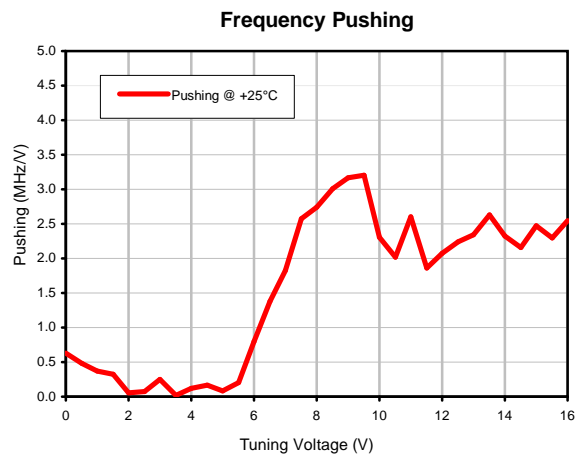
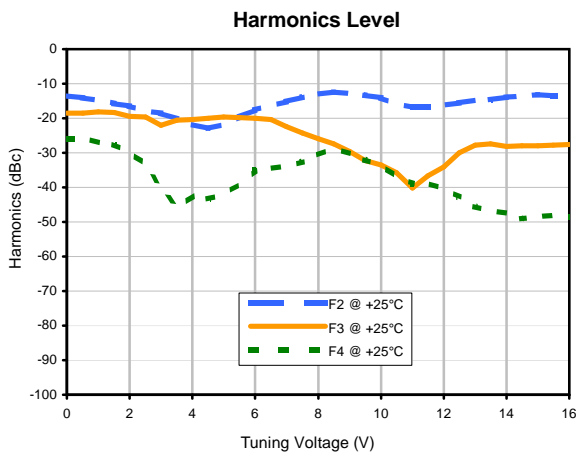
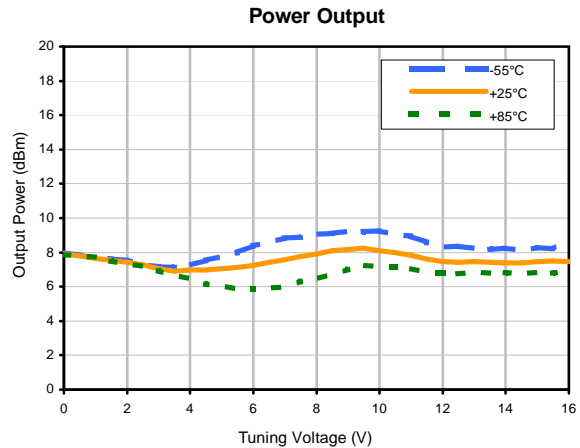
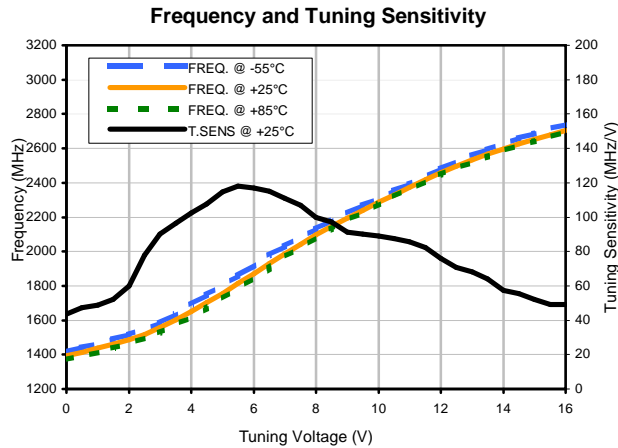

ISO 9001 ISO 14001 AS 9100 CERTIFIED

For detailed performance specs & shopping online see web site

P.O. Box 350166, Brooklyn, New York 11235-0008 (718) 934-4500 Fax (718) 332-4661 The Design Engineers Search Engine Provides ACTUAL Data Instantly at [minicircuits.com](http://minicircuits.com)

RF/MW MICROWAVE COMPONENTS

Notes: 1. Performance and quality attributes and conditions not expressly stated in this specification sheet are intended to be excluded and do not form a part of this specification sheet. 2. Electrical specifications and performance data contained herein are based on Mini-Circuits' applicable established test performance criteria and measurement instructions. 3. The parts covered by this specification sheet are subject to Mini-Circuits' standard limited warranty and terms and conditions (collectively, "Standard Terms"). Purchases of this part are entitl to the rights and benefits contained therein. For a full statement of the Standard Terms and the exclusive rights and remedies thereunder, please visit Mini-Circuits' website at [www.minicircuits.com/MC3\\_ShortTerms.jsp](http://www.minicircuits.com/MC3_ShortTerms.jsp).

REV. OR  
ROS-2500+

111207

Page 1 of 1

## Outline Dimensions

## PCB Land Pattern

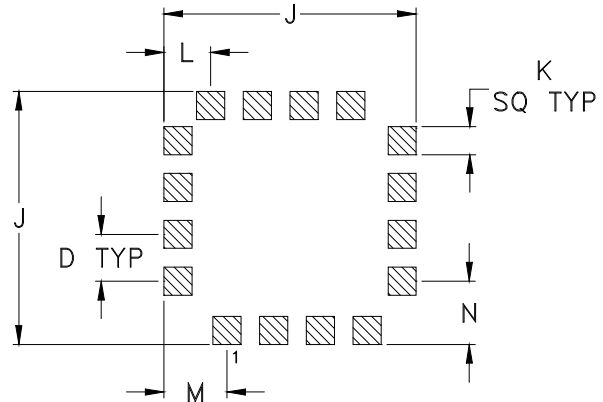

Suggested Layout,  
Tolerance to be within  $\pm .002$

CASE #	A	B	C	D	E	F	G	H	J	K
CK605	.500 (12.70)	.500 (12.70)	.180 (4.57)	.100 (2.54)	.080 (2.03)	.115 (2.92)	.060 (1.52)	.040 (1.02)	.540 (13.72)	.060 (1.52)

CASE #	L	M	N	P	Q	R	S	T	WT. GRAM
CK605	.100 (2.54)	.135 (3.43)	.135 (3.43)	.115 (2.92)	.140 (3.56)	.070 (1.78)	.150 (3.81)	.070 (1.78)	1.2 +0.5 -0.0

Dimensions are in inches (mm). Tolerances: 2 Pl.  $\pm .03$ ; 3Pl.  $\pm .015$

### Notes:

- Case material: Nickel-Silver alloy.
- Base: Printed wiring laminate.
- Termination finish:  
For RoHS Case Styles: 3-5  $\mu$  inch (.08-.13 microns) Gold over 120-240  $\mu$  inch (3.05-6.10 microns) Nickel plate.  
All models, (+) suffix.



P.O. Box 350166, Brooklyn, New York 11235-0003 (718) 934-4500 Fax (718) 332-4661 For detailed performance specs & shopping online see Mini-Circuits web site



The Design Engineers Search Engine Provides ACTUAL Data Instantly From MINI-CIRCUITS At: [www.minicircuits.com](http://www.minicircuits.com)

RF/IF MICROWAVE COMPONENTS

# Tape & Reel Packaging TR-F37



Tape Width, mm	Device Cavity Pitch, mm	Reel Size, inches	Devices per Reel	
24	16	7	Small quantity standards (see note)	10
				20
				50
				100
		13	Standard	200
500				

Note: Please consult individual model data sheet to determine device per reel availability.

Mini-Circuits carrier tape materials provide protection from ESD (Electro-Static Discharge) during handling and transportation. Tapes are static dissipative and comply with industry standards EIA-481/EIA-541.

Go to: [www.minicircuits.com/pages/pdfs/tape.pdf](http://www.minicircuits.com/pages/pdfs/tape.pdf)



INTERNET <http://www.minicircuits.com>

P.O. Box 350166, Brooklyn, New York 11235-0003 (718) 934-4500 Fax (718) 332-4661

Distribution Centers NORTH AMERICA 800-654-7949 • 417-335-5935 • Fax 417-335-5945 • EUROPE 44-1252-832600 • Fax 44-1252-837010

Mini-Circuits ISO 9001 & ISO 14001 Certified

THIRD ANGLE PROJECTION



REVISIONS

REV	ECN No.	DESCRIPTION	DATE	DR	AUTH
E	M105563	ADDED "r1" PIN CONNECTION	06/02/06	MMG	DJ
F	M105640	CORRECTED NOTE 2	06/08/06	MMG	MM
G	M124395	ADDED "RAMP"	09/09	EM	HH
G	R77589	ADDED "RAMP"	09/09	EM	HH

SUGGESTED MOUNTING CONFIGURATION FOR CK605 CASE STYLE, "kg/rl/16AM01" PIN CONNECTION



NOTES:

1. TRACE WIDTH IS SHOWN FOR FR4 WITH DIELECTRIC THICKNESS .030" ± .002"; COPPER: 1/2 OZ. EACH SIDE. FOR OTHER MATERIALS TRACE WIDTH MAY NEED TO BE MODIFIED.
2. BOTTOM SIDE OF THE BOTTOM IS CONTINUOUS GROUND PLANE.



DENOTES PCB COPPER LAYOUT WITH SMOBC (SOLDER MASK OVER BARE COPPER)

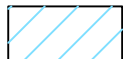

DENOTES COPPER LAND PATTERN FREE OF SOLDER MASK

UNLESS OTHERWISE SPECIFIED	INITIALS	DATE
DIMENSIONS ARE IN INCHES	AV	08/07/00
TOLERANCES ON:	SK	08/08/00
2 PL DECIMALS ±	DB	08/08/00
3 PL DECIMALS ± .005		
ANGLES ±		
FRACTIONS ±		

 **Mini-Circuits®** 13 Neptune Avenue  
Brooklyn NY 11235

PL,kg/rl/16AM01,CK605,ROS/LAVI/RAMP

SIZE	CODE IDENT	DRAWING NO:	REV:
A	15542	98-PL-012	G
FILE:	98PL012	SCALE: 5:1	SHEET: 1 OF 1

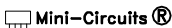
 Mini-Circuits®  
THIS DOCUMENT AND ITS CONTENTS ARE THE PROPERTY OF MINI-CIRCUITS. EXCEPT FOR USE EXPRESSLY GRANTED, IN WRITING, TO ITS VENDORS, VENDEE AND THE UNITED STATES GOVERNMENT, MINI-CIRCUITS RESERVES ALL PROPRIETARY DESIGN, USE, MANUFACTURING AND REPRODUCTION RIGHTS THERETO. THESE CONTENTS SHALL NOT BE USED, DUPLICATED OR DISCLOSED TO ANY OUTSIDE PARTY, IN WHOLE OR IN PART, WITHOUT WRITTEN PERMISSION OF MINI-CIRCUITS.

# Evaluation Board and Circuit



Schematic Diagram

## Notes:

1. SMA Female connectors.
2. PCB Material: Rogers R04350 or equivalent,  
Dielectric Constant=3.5, Thickness=.030 inch.

 **Mini-Circuits®**



All Mini-Circuits products are manufactured under exacting quality assurance and control standards, and are capable of meeting published specifications after being subjected to any or all of the following physical and environmental test.

Specification	Test/Inspection Condition	Reference/Spec
Operating Temperature	-55° to 85°C Ambient Environment	Individual Model Data Sheet
Storage Temperature	-55° to 100° C Ambient Environment	Individual Model Data Sheet
Humidity	90 to 95% RH, 240 hours, 50°C	MIL-STD-202, Method 103, Condition A, Except 50°C and end-point electrical test done within 12 hours
Thermal Shock	-55° to 100°C, 100 cycles	MIL-STD-202, Method 107, Condition A-3, except +100°C
Solder Reflow Heat	Sn-Pb Eutectic Process: 225°C peak Pb-Free Process, 245°C peak	J-STD-020, Table 4-1, 4-2 and 5-2, Figure 5-1
Solderability	10X Magnification	J-STD-002, Para 4.2.5, Test S, 95% Coverage
Vibration (High Frequency)	20g peak, 20-2000 Hz, 4 times in each of three axes (total 12)	MIL-STD-883, Method 2007.3, Condition A
Mechanical Shock	50g, 11 ms, 1/2-sine, 18 shocks: 3 each direction, each of 3 axes	MIL-STD-202, Method 213, Condition A
Marking Resistance to Solvents	Isopropyl alcohol + mineral spirits at 25°C; terpene defluxer at 25°C; distilled water + proylene glycol monomethyl ether + monoethanolamine at 63°C to 70°C	MIL-STD-202, Method 215