

# X5 Frequency Multiplier

## RMK-5-52+

50Ω Output 250 to 500 MHz

### The Big Deal

- Low conversion loss, 22 dB typ.
- High harmonic suppression: F4, 56 dBc; F6, 57 dBc
- Small size, 0.25 x 0.31 x 0.16"



CASE STYLE: TT1224

### Product Overview

Mini-Circuits' RMK-5-52+ frequency multiplier provides a multiplication factor of 5 converting input frequencies from 50 to 100 MHz into output frequencies from 250 to 500 MHz, supporting applications including synthesizers, local oscillators, satellite up and down converters and more. This model supports input power of +17 dBm with conversion loss of 22 dB and excellent harmonic suppression. The multiplier comes housed in a miniature surface-mount package (0.25 x 0.31 x 0.16"), ideal for dense circuit board layouts.

Feature	Advantages
Low conversion loss, 22 dB	With a low conversion loss, the unit produces higher output power, reducing the need for amplification.
Very good harmonic suppression <ul style="list-style-type: none"><li>• F4, 56 dBc</li><li>• F6, 57 dBc</li></ul>	Reduces spurious signals and the need for additional filtering
Low cost	Provides an easy, cost-effective solution for generating high-frequency signals from a lower frequency signal source.
Small size	Measuring only 0.25 x 0.31 x 0.16", the RMK-5-52+ saves space in crowded PCB layouts.

#### Notes

- A. Performance and quality attributes and conditions not expressly stated in this specification document are intended to be excluded and do not form a part of this specification document.  
B. Electrical specifications and performance data contained in this specification document are based on Mini-Circuit's applicable established test performance criteria and measurement instructions.  
C. The parts covered by this specification document are subject to Mini-Circuits standard limited warranty and terms and conditions (collectively, "Standard Terms"); Purchasers of this part are entitled to the rights and benefits contained therein. For a full statement of the Standard Terms and the exclusive rights and remedies thereunder, please visit Mini-Circuits' website at [www.minicircuits.com/MCLStore/terms.jsp](http://www.minicircuits.com/MCLStore/terms.jsp)



# X5 Frequency Multiplier

50Ω Output 250 to 500 MHz

RMK-5-52+



Generic photo used for illustration purposes only  
CASE STYLE: TT1224

**+RoHS Compliant**  
The +Suffix identifies RoHS Compliance. See our web site for RoHS Compliance methodologies and qualifications

Available Tape and Reel	
Reel Size	Devices/Reel
7"	10, 20, 50, 100, 200
13"	500

## Maximum Ratings

Operating Temperature	-40°C to 85°C
Storage Temperature	-55°C to 100°C
RF Input Power	20 dBm

Permanent damage may occur if any of these limits are exceeded.

## Pin Connections

INPUT	1
OUTPUT	4
GROUND	2,3,5,6

## Features

- low conversion loss, 22 dB typ.
- high rejection of adjacent harmonics, 56 dBc typ.
- aqueous washable

## Applications

- synthesizers
- local oscillators
- satellite up and down converters

## Electrical Specifications at 25°C

Parameter	Min.	Typ.	Max.	Unit
Multiplier Factor		5		
Frequency Range, Input (F1)	50	—	100	MHz
Frequency Range, Output (F5)	250	—	500	MHz
Input Power	—	17	—	dBm
Conversion Loss	—	22	26	dB
Harmonic Output*	F1	-8	2	—
	F2	40	63	—
	F3	-12	-2.5	—
	F4	40	56	—
	F6	40	57	—
	F7	-1	6	—

\* Harmonics of input frequency below the power level of F5

## Outline Drawing

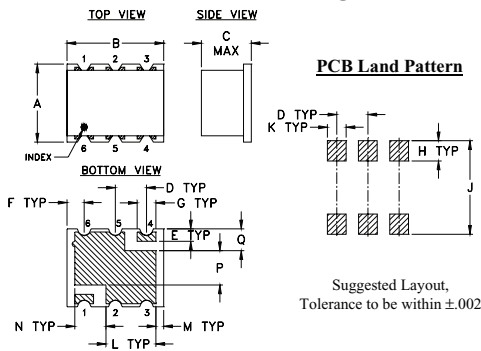

## Outline Dimensions (inch/mm)

A	B	C	D	E	F	G	H	
.25	.31	.16	.100	.040	.055	.060	.065	
6.35	7.87	4.06	2.54	1.02	1.40	1.52	1.65	
J	K	L	M	N	P	Q	wt.	
.300	.060	.160	.025	.100	.110	.070	grams	
7.62	1.52	4.06	0.64	2.54	2.79	1.78	0.16	

## Demo Board MCL P/N: TB-393 Suggested PCB Layout (PL-258)

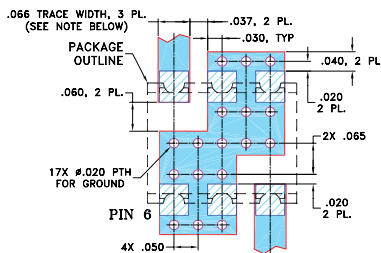

- NOTES: 1. TRACE WIDTH IS SHOWN FOR ROGERS RO4350B WITH DIELECTRIC THICKNESS .030" ± .002"; COPPER: 1/2 OZ. EACH SIDE. FOR OTHER MATERIALS TRACE WIDTH MAY NEED TO BE MODIFIED.  
2. BOTTOM SIDE OF THE PCB IS CONTINUOUS GROUND PLANE.  
■ DENOTES PCB COPPER LAYOUT WITH SMOBC (SOLDER MASK OVER BARE COPPER)  
□ DENOTES COPPER LAND PATTERN FREE OF SOLDER MASK

### Notes

- A. Performance and quality attributes and conditions not expressly stated in this specification document are intended to be excluded and do not form a part of this specification document.  
B. Electrical specifications and performance data contained in this specification document are based on Mini-Circuit's applicable established test performance criteria and measurement instructions.  
C. The parts covered by this specification document are subject to Mini-Circuit's standard limited warranty and terms and conditions (collectively, "Standard Terms"); Purchasers of this part are entitled to the rights and benefits contained therein. For a full statement of the Standard Terms and the exclusive rights and remedies thereunder, please visit Mini-Circuit's website at [www.minicircuits.com/MCLStore/terms.jsp](http://www.minicircuits.com/MCLStore/terms.jsp)



[www.minicircuits.com](http://www.minicircuits.com) P.O. Box 350166, Brooklyn, NY 11235-0003 (718) 934-4500 sales@minicircuits.com

REV. A  
M151107  
RMK-5-52+  
ED-14845  
AV/CP/AM  
200813  
Page 2 of 3

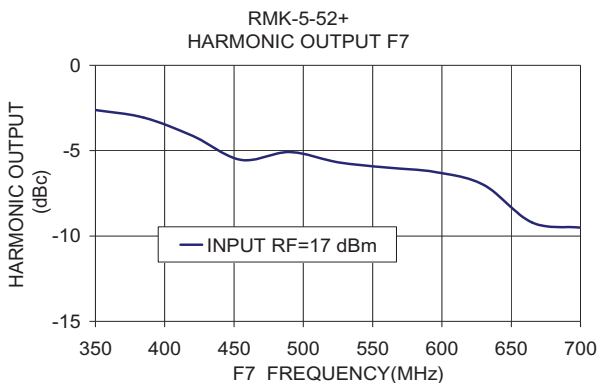
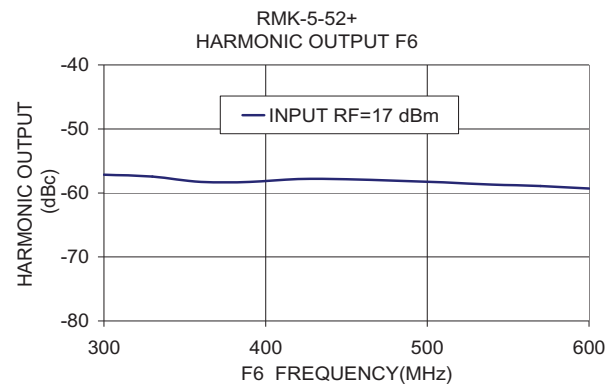
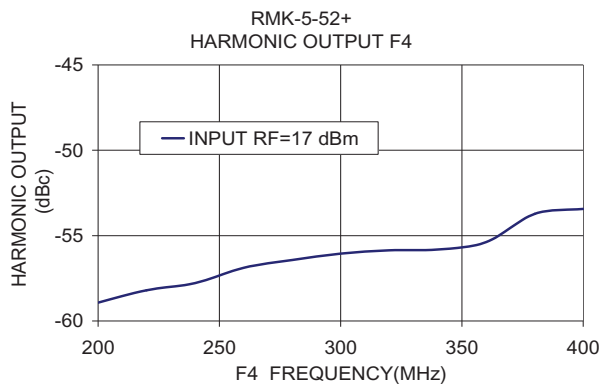
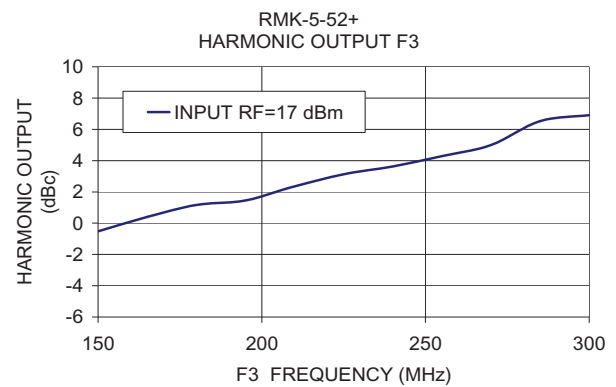
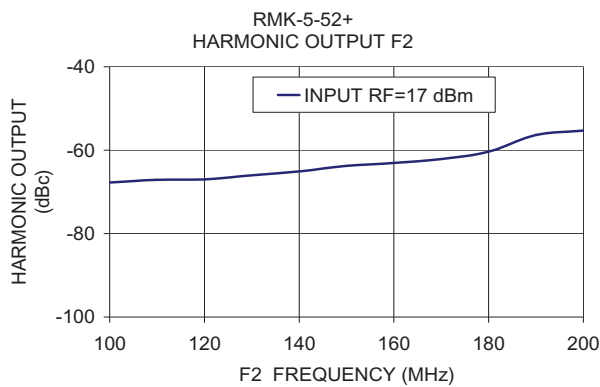
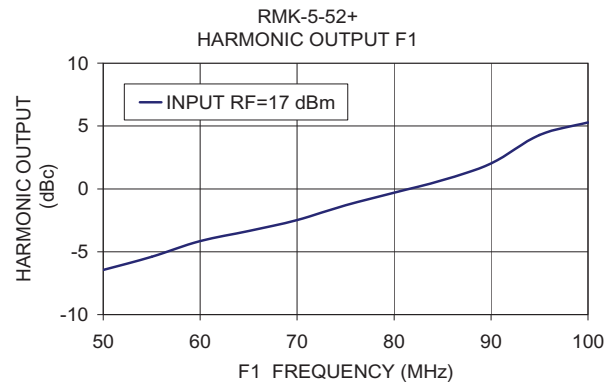
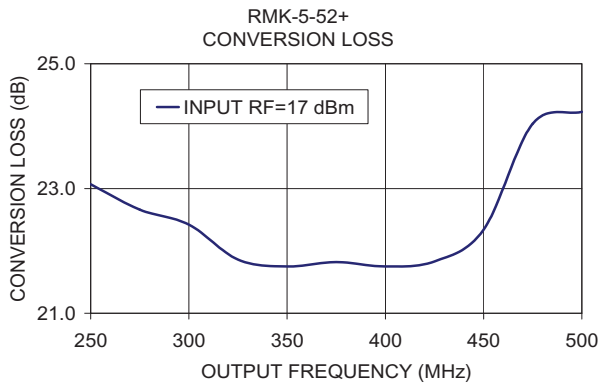

**Notes**

- A. Performance and quality attributes and conditions not expressly stated in this specification document are intended to be excluded and do not form a part of this specification document.
- B. Electrical specifications and performance data contained in this specification document are based on Mini-Circuit's applicable established test performance criteria and measurement instructions.
- C. The parts covered by this specification document are subject to Mini-Circuits standard limited warranty and terms and conditions (collectively, "Standard Terms"); Purchasers of this part are entitled to the rights and benefits contained therein. For a full statement of the Standard Terms and the exclusive rights and remedies thereunder, please visit Mini-Circuits' website at [www.minicircuits.com/MCLStore/terms.jsp](http://www.minicircuits.com/MCLStore/terms.jsp)



# Frequency Multiplier (X5)

**RMK-5-52+**

## Typical Performance Data

FREQUENCY (MHz)							CONVERSION LOSS (dB)	RF IN = +17 dBm					
								HARMONIC OUTPUT* (-dBc)					
X1 OUTPUT	X2 OUTPUT	X3 OUTPUT	X4 OUTPUT	X5 OUTPUT	X6 OUTPUT	X7 OUTPUT	X5 OUTPUT	X1 OUTPUT	X2 OUTPUT	X3 OUTPUT	X4 OUTPUT	X6 OUTPUT	X7 OUTPUT
50	100	150	200	250	300	350	23.07	6.45	67.76	0.52	58.93	57.16	2.62
55	110	165	220	275	330	385	22.66	5.39	67.13	-0.40	58.20	57.45	3.07
60	120	180	240	300	360	420	22.42	4.15	66.99	-1.16	57.78	58.29	4.13
65	130	195	260	325	390	455	21.86	3.35	66.00	-1.45	56.89	58.27	5.54
70	140	210	280	350	420	490	21.75	2.48	65.07	-2.35	56.43	57.84	5.08
75	150	225	300	375	450	525	21.82	1.30	63.74	-3.12	56.05	57.87	5.68
80	160	240	320	400	480	560	21.75	0.30	63.04	-3.62	55.86	58.08	5.99
85	170	255	340	425	510	595	21.83	-0.70	62.12	-4.29	55.81	58.35	6.25
90	180	270	360	450	540	630	22.34	-2.02	60.36	-4.99	55.38	58.69	7.00
95	190	285	380	475	570	665	24.04	-4.28	56.33	-6.53	53.72	58.93	9.21
100	200	300	400	500	600	700	24.23	-5.28	55.31	-6.91	53.43	59.31	9.51

\* Harmonic Output below power level of X5 Output.



P.O. Box 350166, Brooklyn, New York 11235-0003 (718) 934-4500 • Fax (718) 332-4661 For detailed performance specs & shopping online see Mini-Circuits web site



The Design Engineers Search Engine Provides ACTUAL Data Instantly From MINI-CIRCUITS At: [www.minicircuits.com](http://www.minicircuits.com)

**IF/RF MICROWAVE COMPONENTS**

REV. OR  
RMK-5-52+  
1/26/2015  
Page 1 of 1

## Typical Performance Curves

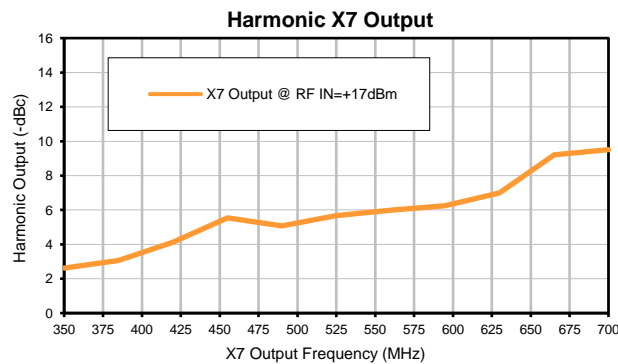
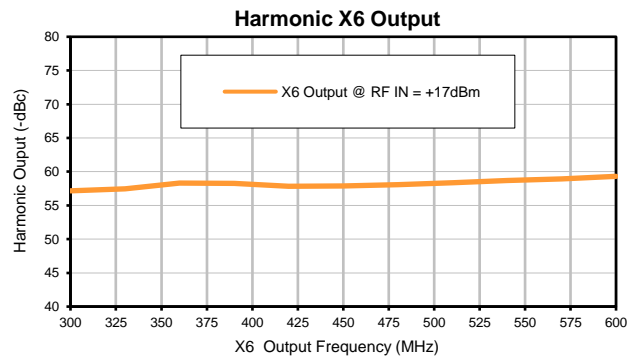
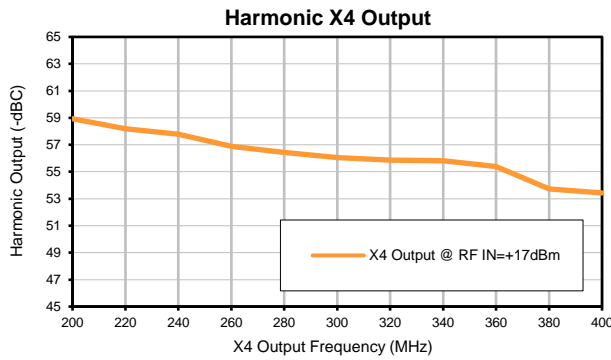
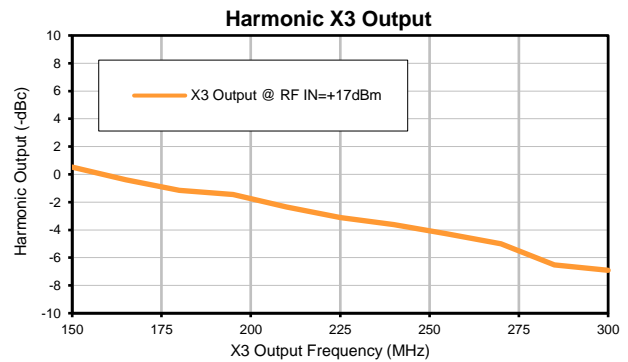
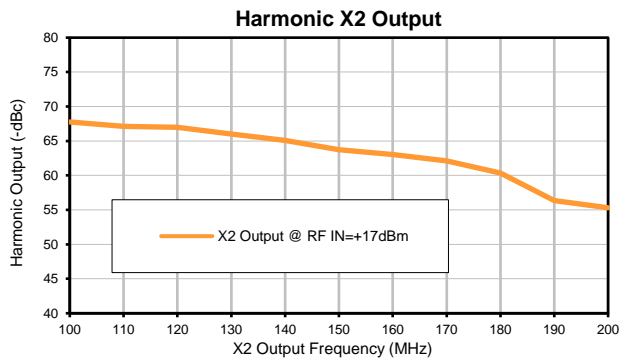
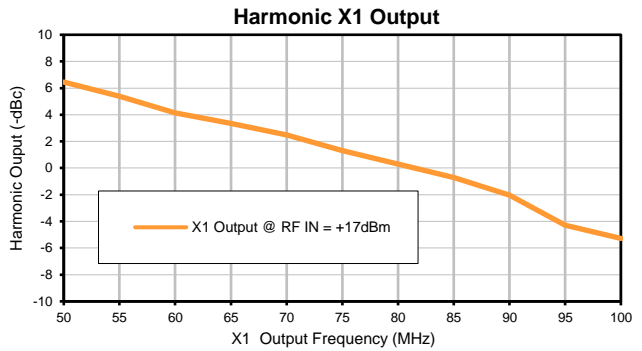
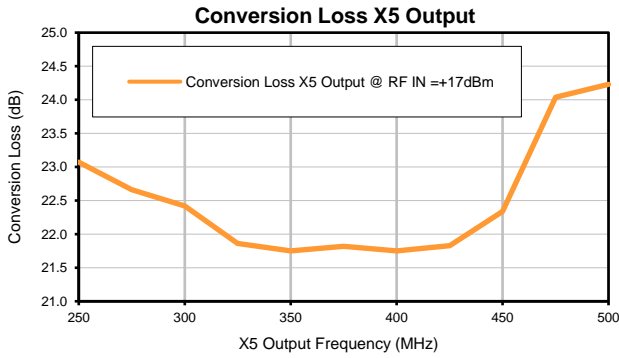

### Outline Dimensions

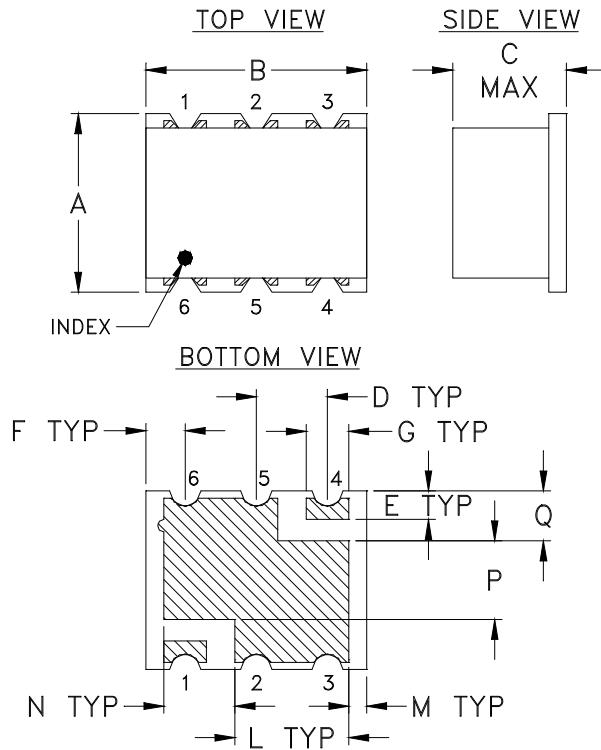

### PCB Land Pattern

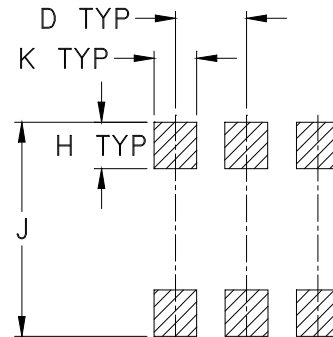

Suggested Layout,  
Tolerance to be within  $\pm .002$

CASE #	A	B	C	D	E	F	G	H	J	K	L
TT1224	.25 (6.35)	.31 (7.87)	.16 (4.06)	.100 (2.54)	.040 (1.02)	.055 (1.40)	.060 (1.52)	.065 (1.65)	.300 (7.62)	.060 (1.52)	.160 (4.06)

CASE #	M	N	P	Q	WT. GRAM
TT1224	.025 (.64)	.100 (2.54)	.110 (2.79)	.070 (1.78)	.16

Dimensions are in inches (mm). Tolerances: 2Pl.  $\pm .01$ ; 3 Pl.  $\pm .005$

#### Notes:

1. Case material: Plastic.
2. Termination: 2-10  $\mu$  inch (.05-.25 microns) Gold over 100-300  $\mu$  inch (2.54-7.62 microns) Nickel plate



P.O. Box 350166, Brooklyn, New York 11235-0003 (718) 934-4500 Fax (718) 332-4661 For detailed performance specs & shopping online see Mini-Circuits web site



The Design Engineers Search Engine Provides ACTUAL Data Instantly From MINI-CIRCUITS At: [www.minicircuits.com](http://www.minicircuits.com)

RF/IF MICROWAVE COMPONENTS

# Tape & Reel Packaging TR-F2

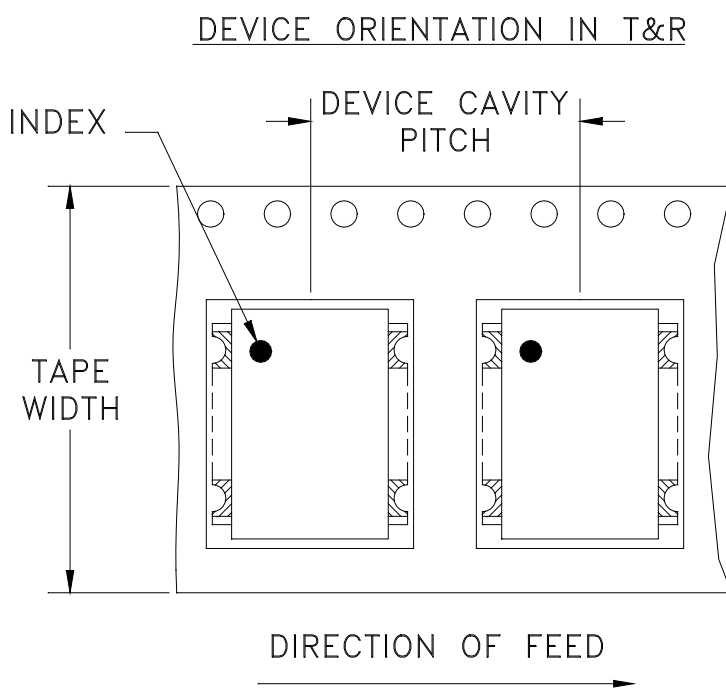

Tape Width, mm	Device Cavity Pitch, mm	Reel Size, inches	Devices per Reel See note
16	12	7	10
			20
			50
			100
			200
		13	500
			1000

Mini-Circuits carrier tape materials provide protection from ESD (Electro-Static Discharge) during handling and transportation. Tapes are static dissipative and comply with industry standards EIA-481/EIA-541.

Go to: [www.minicircuits.com/pages/pdfs/tape.pdf](http://www.minicircuits.com/pages/pdfs/tape.pdf)



INTERNET <http://www.minicircuits.com>

P.O. Box 350166, Brooklyn, New York 11235-0003 (718) 934-4500 Fax (718) 332-4661

Distribution Centers NORTH AMERICA 800-654-7949 • 417-335-5935 • Fax 417-335-5945 • EUROPE 44-1252-832600 • Fax 44-1252-837010

Mini-Circuits ISO 9001 & ISO 14001 Certified

THIRD ANGLE PROJECTION

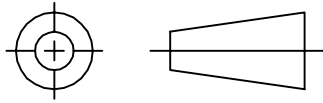

REVISIONS

REV	ECN No.	DESCRIPTION	DATE	DR	AUTH
OR	M108897	NEW RELEASE	01/04/07	AV	DJ

**SUGGESTED MOUNTING CONFIGURATION  
FOR TT1224 CASE STYLE "rv" PIN CONNECTION**

.066 TRACE WIDTH, 3 PL.  
(SEE NOTE BELOW)

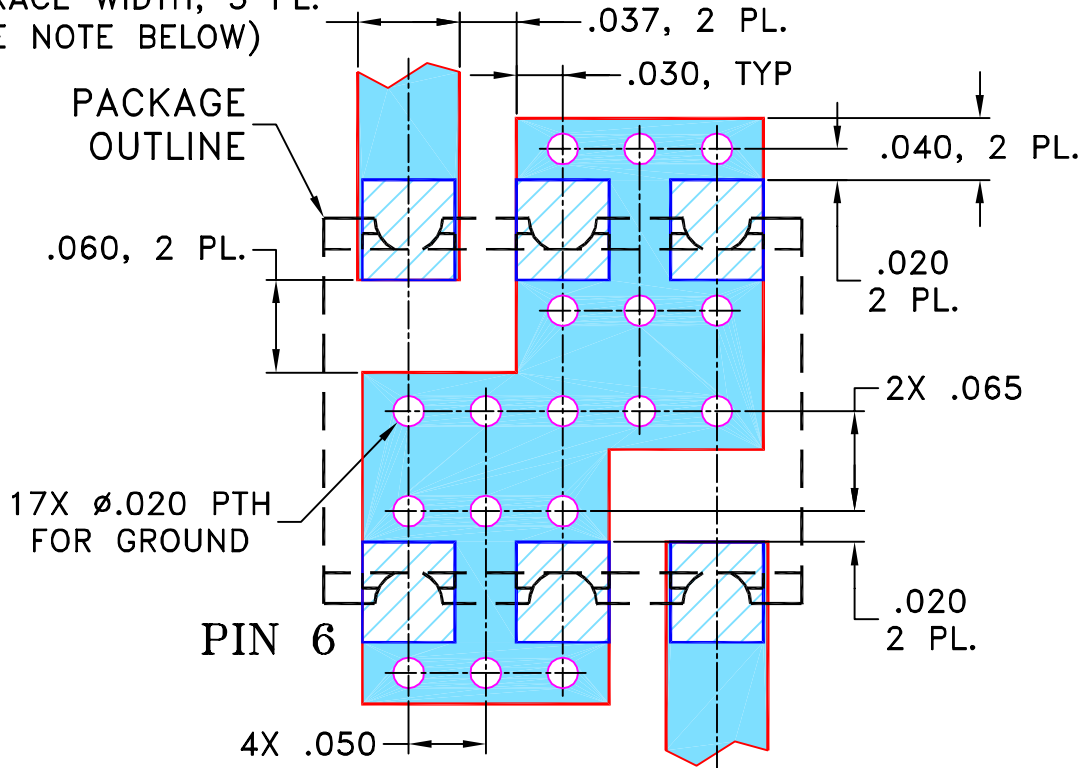

- NOTES: 1. TRACE WIDTH IS SHOWN FOR ROGERS R04350B WITH DIELECTRIC THICKNESS .030" ± .002"; COPPER: 1/2 OZ. EACH SIDE. FOR OTHER MATERIALS TRACE WIDTH MAY NEED TO BE MODIFIED.  
2. BOTTOM SIDE OF THE PCB IS CONTINUOUS GROUND PLANE.



DENOTES PCB COPPER LAYOUT WITH SMOBC  
(SOLDER MASK OVER BARE COPPER)



DENOTES COPPER LAND PATTERN FREE OF SOLDER MASK

UNLESS OTHERWISE SPECIFIED

INITIALS

DATE

DIMENSIONS ARE IN INCHES

DRAWN

AV

12/14/06

TOLERANCES ON:

CHECKED

IL

01/04/07

2 PL DECIMALS ± .005

APPROVED

DJ

01/04/07

ANGLES ±

FRACTIONS ±

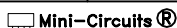

THIS DOCUMENT AND ITS CONTENTS ARE THE PROPERTY OF MINI-CIRCUITS. EXCEPT FOR USE EXPRESSLY GRANTED, IN WRITING, TO ITS VENDORS, VENDEE AND THE UNITED STATES GOVERNMENT, MINI-CIRCUITS RESERVES ALL PROPRIETARY DESIGN, USE, MANUFACTURING AND REPRODUCTION RIGHTS THERETO. THESE CONTENTS SHALL NOT BE USED, DUPLICATED OR DISCLOSED TO ANY OUTSIDE PARTY, IN WHOLE OR IN PART, WITHOUT WRITTEN PERMISSION OF MINI-CIRCUITS.

ASHEETA1.DWG REV:A DATE:01/12/95



Mini-Circuits®

13 Neptune Avenue  
Brooklyn NY 11235

PL, rv, TT1224, RMK-3-662+, TB-393

SIZE  
A

CODE IDENT  
15542

DRAWING NO:  
98-PL-258

REV:  
OR

FILE: 98PL258

SCALE: 8:1

SHEET: 1 OF 1



# Evaluation Board and Circuit

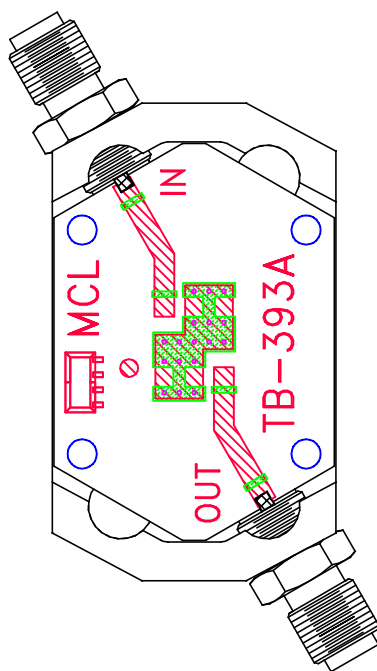

TB-393

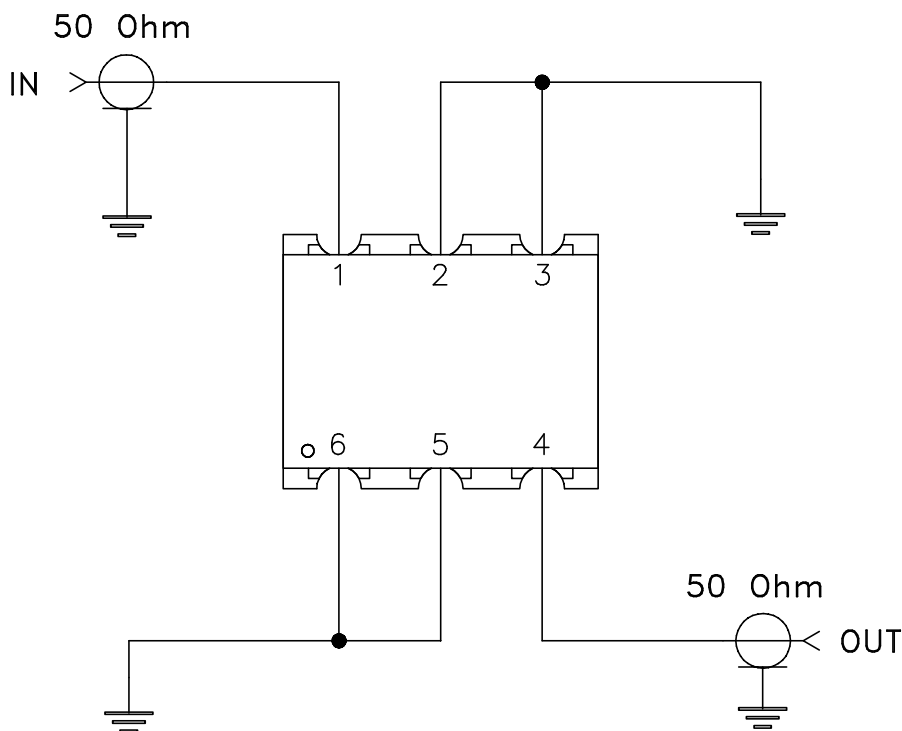

Schematic Diagram

## Notes:

1. SMA Female connectors.
2. PCB Material: Rogers R04350 or equivalent, Dielectric Constant=3.5, Thickness=.030 inch.

 Mini-Circuits®

All Mini-Circuits products are manufactured under exacting quality assurance and control standards, and are capable of meeting published specifications after being subjected to any or all of the following physical and environmental test.

Specification	Test/Inspection Condition	Reference/Spec
Operating Temperature	-40° to 85°C Ambient Environment	Individual Model Data Sheet
Storage Temperature	-55° to 100° C Ambient Environment	Individual Model Data Sheet
Humidity	90 to 95% RH, 240 hours, 50°C	MIL-STD-202, Method 103, Condition A, Except 50°C and end-point electrical test done within 12 hours
Thermal Shock	-55° to 100°C, 100 cycles	MIL-STD-202, Method 107, Condition A-3, except +100°C
Solder Reflow Heat	Sn-Pb Eutetic Process: 225°C peak Pb-Free Process 245° - 250°C peak	J-STD-020, Table 4-1, 4-2 and 5-2, Figure 5-1
Solderability	10X Magnification	J-STD-002, 95% Coverage
Vibration (High Frequency)	20g peak, 10-2000 Hz, 12 times in each of three perpendicular directions (total 36)	MIL-STD-202, Method 204, Condition D
Mechanical Shock	50g, 11 ms, 1/2-sine, 18 shocks: 3 each direction, each of 3 axes	MIL-STD-202, Method 213, Condition A
Marking Resistance to Solvents	Isopropyl alcohol + mineral spirits at 25°C; terpene defluxer at 25°C; distilled water + proylene glycol monomethyl ether + monoethanolamine at 63°C to 70°C	MIL-STD-202, Method 215