

# Surface Mount <sup>top hat</sup> Directional Coupler

## RDC-17-122-75X+

75Ω    17dB    5 to 1250 MHz

### The Big Deal

- Low mainline loss, 0.8 dB
- High directivity, 20 dB
- Good Return Loss, 24 dB
- Excellent coupling flatness,  $\pm 0.25$  dB
- Supports DOCSIS® 3.1 Systems



CASE STYLE: TT2315

### Product Overview

Mini-Circuits RDC-17-122-75X+ surface-mount directional coupler provides 17 dB coupling with excellent flatness, low mainline loss, high directivity, and good return loss for 75Ω applications from 5 to 1250 MHz, supporting a variety of broadband applications including DOCSIS 3.1 systems and equipment. This model features core and wire construction with wrap-around terminations for good solderability and easy visual inspection.

### Key Features

Feature	Advantages
Broadband, 5 to 1250 MHz	Supports bandwidth requirements for DOCSIS 3.1 systems and equipment.
Low mainline loss, 0.8 dB	Provides excellent through-path signal transmission and maintains low heat dissipation, avoiding the need for special heat sinking methods.
Power handling, up to 1W	Usable in systems with a variety of signal power requirements.
Excellent return loss, 24 dB typ.	Provides excellent matching for 50Ω systems.
High directivity, 20 dB	High directivity allows accurate signal sampling through the coupled port with minimal measurement error.
Top Hat feature	Improves speed and accuracy of pick and place assembly.

# Surface Mount <sup>top hat</sup> Directional Coupler

75Ω 17dB 5 to 1250 MHz

## RDC-17-122-75X+

### Features

- wideband, 5-1250 MHz
- excellent return loss, 24 dB typ.
- low mainline loss, 0.8 dB typ.
- high directivity, 20 dB typ.
- excellent coupling flatness, ±0.25 dB typ.
- aqueous washable

### Applications

- DOCSIS 3.1
- cable tv

### Electrical Specifications at 25°C

Parameter	Condition (MHz)	Min.	Typ.	Max.	Unit
Frequency Range		5		1250	MHz
Mainline Loss <sup>1</sup>	5 - 1000	—	0.8	1.0	dB
	1000 - 1250	—	0.9	1.2	
Coupling	5 - 1250	—	17.6	—	dB
Coupling Flatness (±)	5 - 1000	—	0.45	0.9	dB
	1000 - 1250	—	0.25	0.6	
Directivity	5 - 50	25	30	—	dB
	50 - 870	18	25	—	
	870 - 1250	11	16	—	
Return Loss (Input)	5 - 1250	18	24	—	dB
Return Loss (Output)	5 - 1250	18	25	—	dB
Return Loss (Coupling)	5 - 1250	18	24	—	dB
Input Power	5 - 1250	—	—	1.0	W

1. Mainline loss includes theoretical power loss at coupled



Generic photo used for illustration purposes only

CASE STYLE: TT2315

### +RoHS Compliant

The +Suffix identifies RoHS Compliance. See our web site for RoHS Compliance methodologies and qualifications

### Maximum Ratings

Parameter	Ratings
Operating Temperature	-40°C to 85°C
Storage Temperature	-55°C to 100°C

Permanent damage may occur if any of these limits are exceeded.

### Pin Connections

Function	Pin Number
INPUT	1
OUTPUT	6
COUPLED	3
GROUND	2
75Ω TERM EXTERNAL	4
ISOLATE (DO NOT USE)	5

### Product Marking

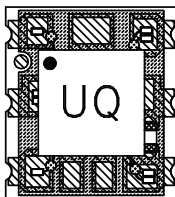

### Electrical Schematic

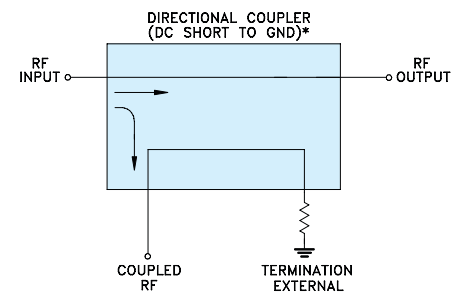

\* ELECTRICAL SCHEMATIC IS FOR DIRECTIONAL COUPLER WITH INTERNAL TRANSFORMER(S) AND EXTERNAL TERMINATION.

## Outline Drawing

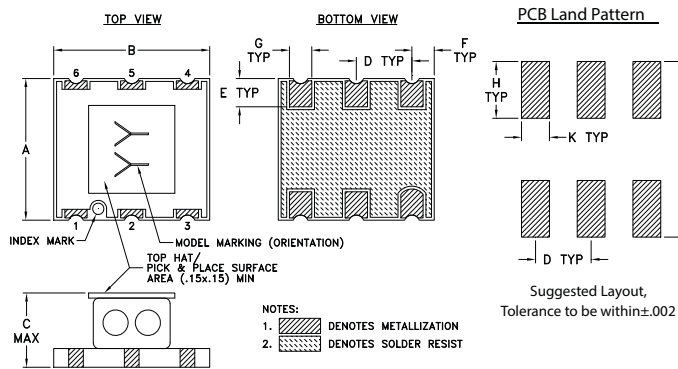

## Outline Dimensions (inch/mm)

A	B	C	D	E	F
.250	.280	.140	.100	.050	.040
6.35	7.11	3.56	2.54	1.27	1.02
G	H	J	K	wt.	
.040	.100	.310	.050	grams	
1.02	2.54	7.87	1.27	0.35	

## Demo Board MCL P/N: TB-917+ Suggested PCB Layout (PL-452)

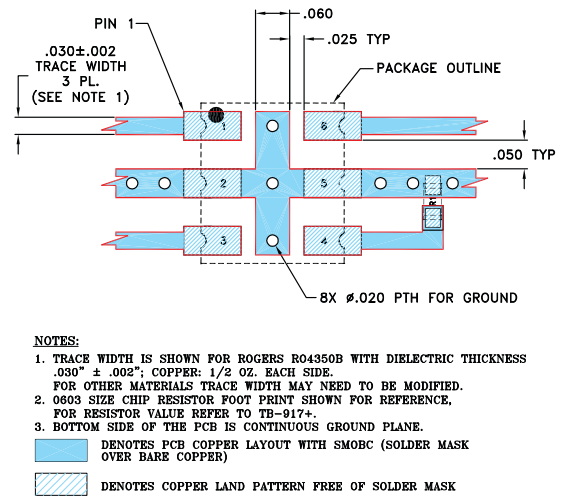

## Typical Performance Data

Frequency (MHz)	Mainline Loss (dB) In-Out	Coupling (dB) In-Cpl	Directivity (dB)	Return Loss (dB)		
				In	Out	Cpl
5	0.72	17.98	28.79	20.90	22.55	20.74
20	0.59	17.75	32.44	24.13	27.41	23.94
50	0.60	17.72	36.13	24.60	28.37	24.18
100	0.62	17.72	40.69	25.14	29.38	24.52
200	0.64	17.74	45.55	25.90	31.66	25.31
400	0.67	17.75	35.63	26.23	30.64	25.95
600	0.71	17.74	25.23	27.35	28.80	27.49
870	0.79	17.72	20.73	27.88	27.88	24.20
1000	0.83	17.68	18.97	26.85	29.23	22.65
1250	0.94	17.47	15.91	26.17	46.02	20.26

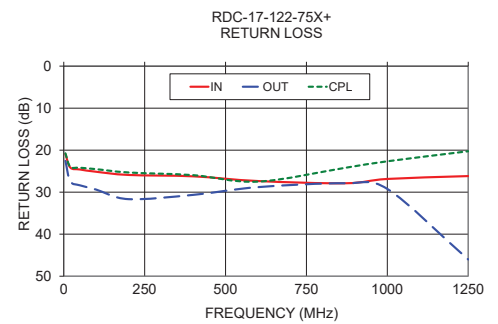
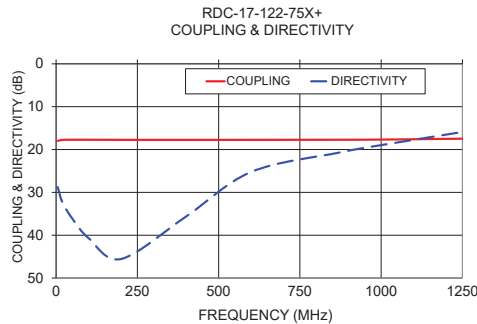
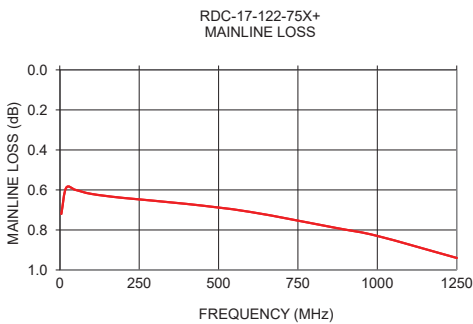

## Additional Notes

- Performance and quality attributes and conditions not expressly stated in this specification document are intended to be excluded and do not form a part of this specification document.
- Electrical specifications and performance data contained in this specification document are based on Mini-Circuits' applicable established test performance criteria and measurement instructions.
- The parts covered by this specification document are subject to Mini-Circuits standard limited warranty and terms and conditions (collectively, "Standard Terms"); Purchasers of this part are entitled to the rights and benefits contained therein. For a full statement of the Standard Terms and the exclusive rights and remedies thereunder, please visit Mini-Circuits' website at [www.minicircuits.com/MCLStore/terms.jsp](http://www.minicircuits.com/MCLStore/terms.jsp)

# Directional Coupler

## Typical Performance Data

# RDC-17-122-75X+

FREQUENCY (MHz)	INSERTION LOSS (dB)	COUPLING (dB)	DIRECTIVITY (dB)	RETURN LOSS (dB)		
				IN	OUT	CPL
5	0.72	17.98	28.79	20.90	22.55	20.74
10	0.61	17.81	30.31	23.17	25.74	23.10
15	0.60	17.76	31.49	23.90	26.95	23.76
20	0.59	17.75	32.44	24.13	27.41	23.94
25	0.59	17.73	33.27	24.28	27.67	24.02
30	0.60	17.73	33.92	24.37	27.85	24.08
35	0.60	17.72	34.57	24.44	28.03	24.12
40	0.60	17.72	35.05	24.51	28.17	24.14
45	0.60	17.72	35.51	24.54	28.25	24.17
50	0.60	17.72	36.13	24.60	28.37	24.18
60	0.60	17.72	37.07	24.68	28.54	24.23
70	0.61	17.71	38.01	24.78	28.69	24.27
80	0.61	17.72	38.79	24.91	28.78	24.33
90	0.61	17.72	39.60	25.01	29.04	24.42
100	0.62	17.72	40.69	25.14	29.38	24.52
150	0.63	17.74	46.18	25.58	31.76	25.13
200	0.64	17.74	45.55	25.90	31.66	25.31
300	0.66	17.76	39.66	25.99	31.44	25.49
400	0.67	17.75	35.63	26.23	30.64	25.95
500	0.69	17.75	29.53	26.59	29.39	26.74
600	0.71	17.74	25.23	27.35	28.80	27.49
700	0.74	17.75	22.95	28.11	29.46	27.24
800	0.77	17.74	21.41	28.26	28.41	25.49
870	0.79	17.72	20.73	27.88	27.88	24.20
900	0.80	17.71	20.39	27.66	27.91	23.76
1000	0.83	17.68	18.97	26.85	29.23	22.65
1100	0.87	17.62	17.77	26.29	31.43	21.92
1200	0.92	17.53	16.54	25.90	37.33	20.89
1225	0.93	17.50	16.23	26.06	40.84	20.55
1250	0.94	17.47	15.91	26.17	46.02	20.26

# Directional Coupler

## Typical Performance Curves

RDC-17-122-75X+

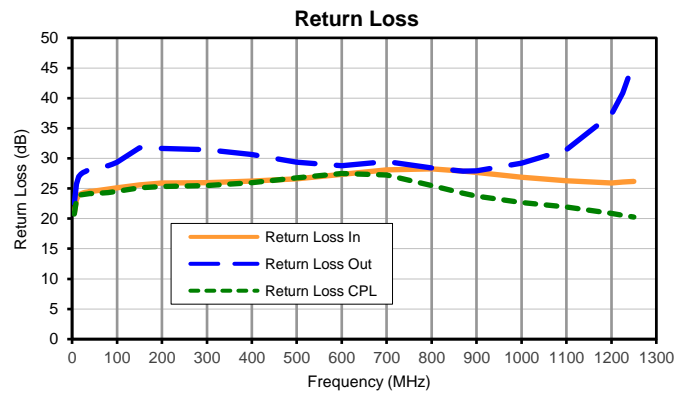
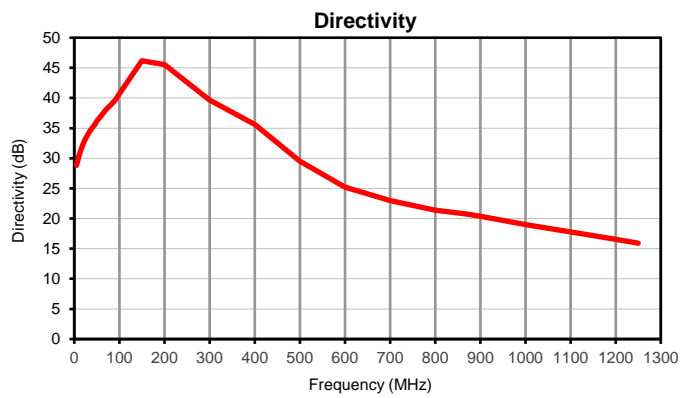
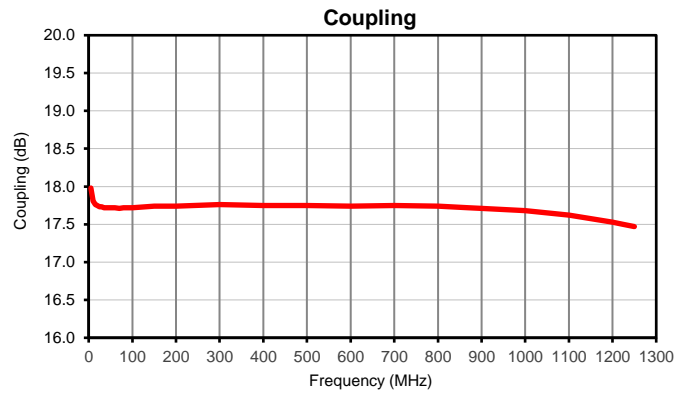
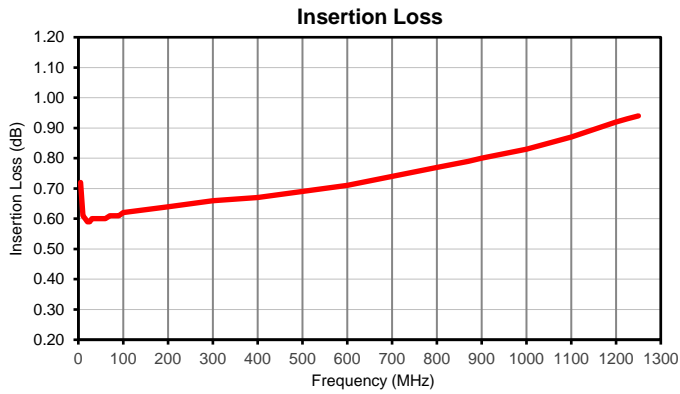

## Outline Dimensions

TT2315

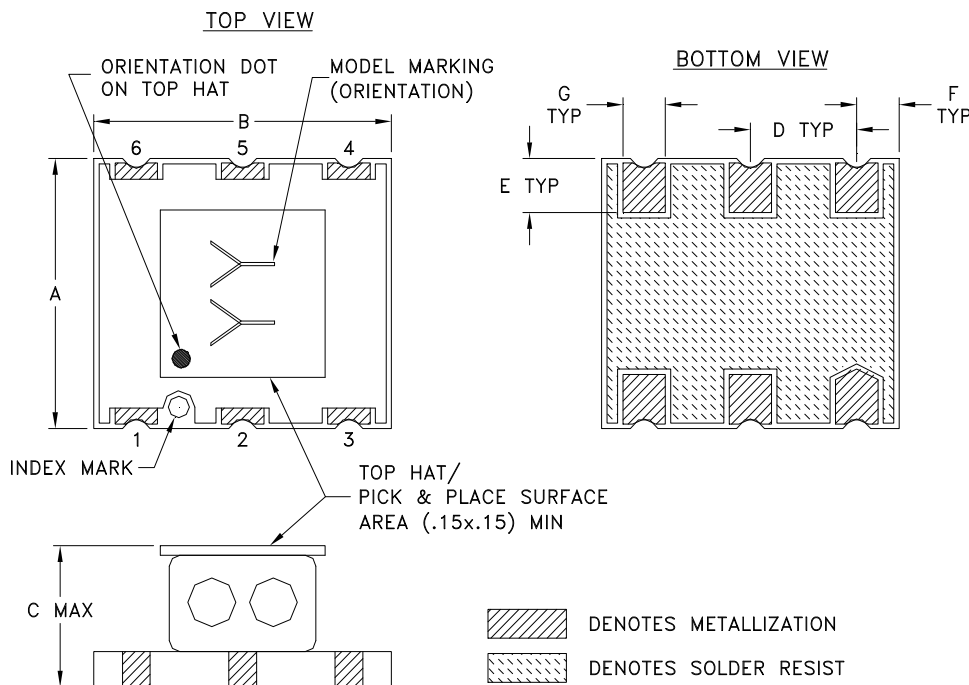

## PCB Land Pattern

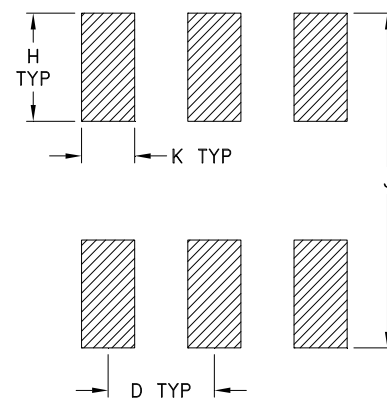

SUGGESTED LAYOUT  
TOLERANCE TO BE WITHIN  $\pm 0.02$

CASE #	A	B	C	D	E	F	G	H	J	K	WT. GRAMS
TT2315	.250 (6.35)	.280 (7.11)	.140 (3.56)	.100 (2.54)	.050 (1.27)	.040 (1.02)	.040 (1.02)	.100 (2.54)	.310 (7.87)	.050 (1.27)	.35

Dimensions are in inches (mm). Tolerances: 2Pl.  $\pm .01$ ; 3 Pl.  $\pm .005$

### Notes:

- Open style, Base material: Printed wiring laminate.
- Termination finish: 3-5  $\mu$  inch (.08-.13 microns) Gold over 120-240  $\mu$  inch (3.05-6.10 microns) Nickel plate.  
All models, (+) suffix.
- Top-Hat total thickness: .013 inches MAX.
- Orientation Dot on Top Hat & PCB corresponds to Pin #1.



P.O. Box 350166, Brooklyn, New York 11235-0003 (718) 934-4500 Fax (718) 332-4661 For detailed performance specs & shopping online see Mini-Circuits web site



The Design Engineers Search Engine Provides ACTUAL Data Instantly From MINI-CIRCUITS At: [www.minicircuits.com](http://www.minicircuits.com)

RF/IF MICROWAVE COMPONENTS

# Tape & Reel Packaging TR-F34

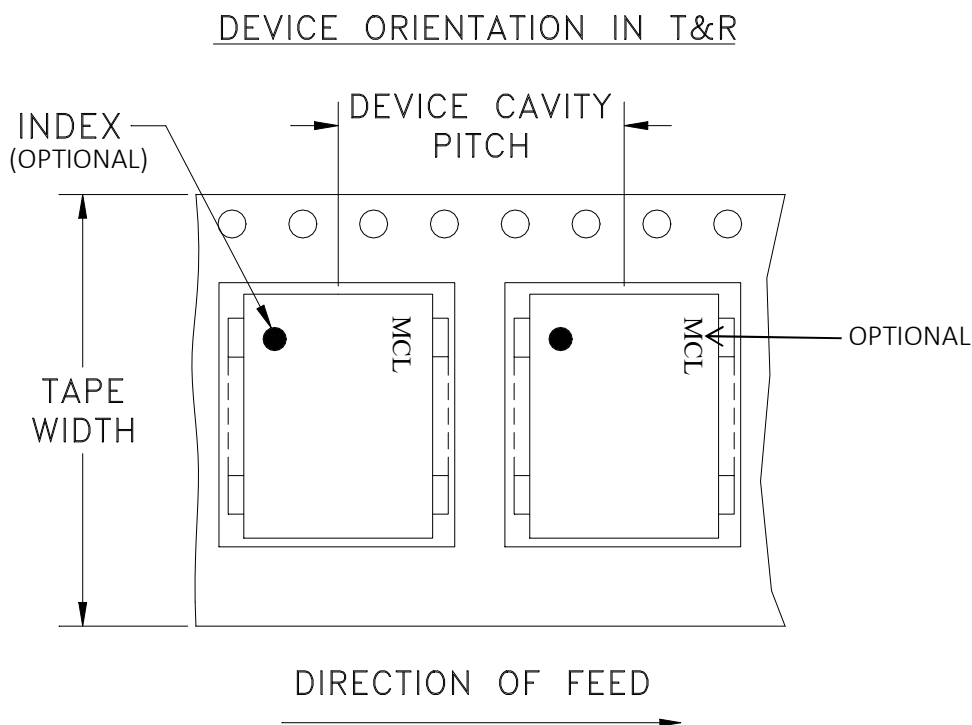

Tape Width, mm	Device Cavity Pitch, mm	Reel Size, inches	Devices per Reel see note	
16	12	7	Small quantity standard (see note)	20
				50
			Standard	100
				200
		13	Standard	500
				1000

Note: Availability of small reel quantity varies by model.  
Refer to pricing and availability on individual model dashboard.

Mini-Circuits carrier tape materials provide protection from ESD (Electro-Static Discharge) during handling and transportation. Tapes are static dissipative and comply with industry standards EIA-481/EIA-541.

Go to: [www.minicircuits.com/pages/pdfs/tape.pdf](http://www.minicircuits.com/pages/pdfs/tape.pdf)



INTERNET <http://www.minicircuits.com>

P.O. Box 350166, Brooklyn, New York 11235-0003 (718) 934-4500 Fax (718) 332-4661

Distribution Centers NORTH AMERICA 800-654-7949 • 417-335-5935 • Fax 417-335-5945 • EUROPE 44-1252-832600 • Fax 44-1252-837010

Mini-Circuits ISO 9001 & ISO 14001 Certified

THIRD ANGLE PROJECTION

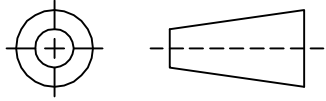

REVISIONS

REV	ECN No.	DESCRIPTION	DATE	DR	AUTH
OR	M158078	NEW RELEASE	09/16/16	CA	IL

**SUGGESTED MOUNTING CONFIGURATION  
FOR TT2315 CASE STYLE, "06DC03" PIN CODE**

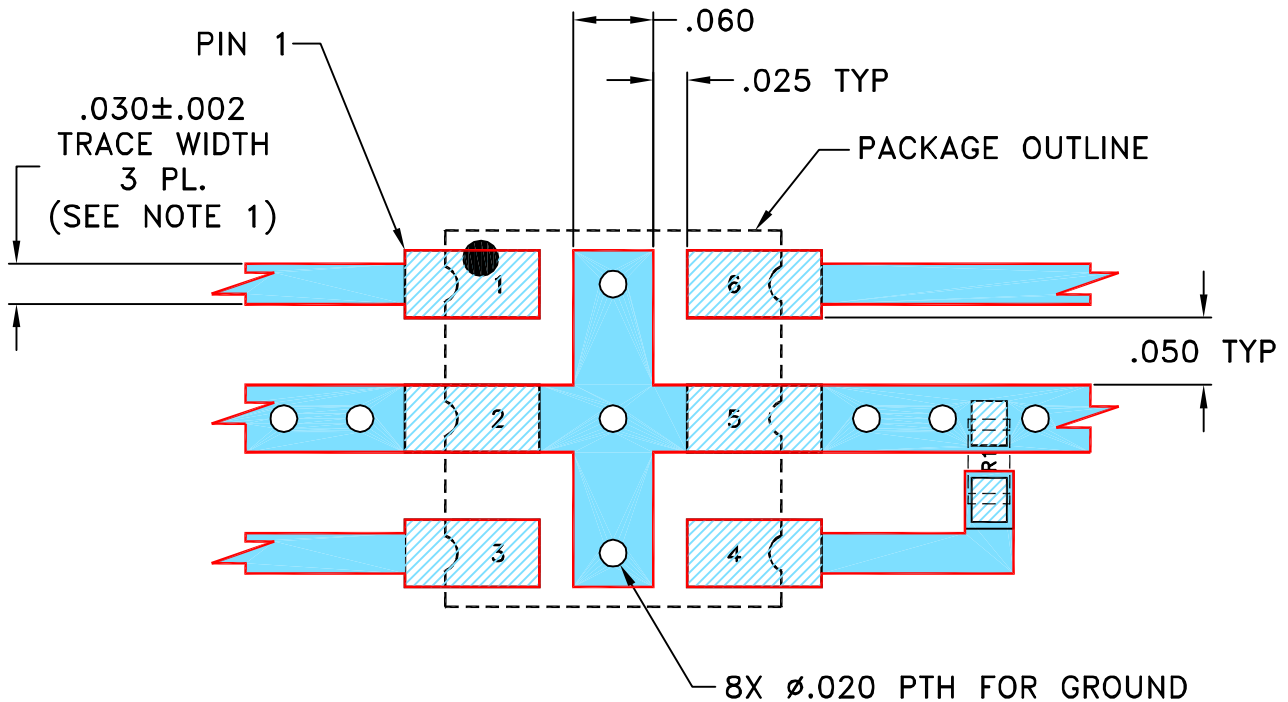

**NOTES:**

1. TRACE WIDTH IS SHOWN FOR ROGERS R04350B WITH DIELECTRIC THICKNESS .030" ± .002"; COPPER: 1/2 OZ. EACH SIDE.  
FOR OTHER MATERIALS TRACE WIDTH MAY NEED TO BE MODIFIED.
2. 0603 SIZE CHIP RESISTOR FOOT PRINT SHOWN FOR REFERENCE,  
FOR RESISTOR VALUE REFER TO TB-917+.
3. BOTTOM SIDE OF THE PCB IS CONTINUOUS GROUND PLANE.

DENOTES PCB COPPER LAYOUT WITH SMOBC (SOLDER MASK OVER BARE COPPER)

DENOTES COPPER LAND PATTERN FREE OF SOLDER MASK

UNLESS OTHERWISE SPECIFIED	INITIALS	DATE
DIMENSIONS ARE IN INCHES TOLERANCES ON: 2 PL DECIMALS ± 3 PL DECIMALS ± .005 ANGLES ± FRACTIONS ±	DRAWN	CA 09/15/16
	CHECKED	IL 09/16/16
	APPROVED	YL 09/16/16

**Mini-Circuits®** 13 Neptune Avenue  
Brooklyn NY 11235

**PL, 06DC03, TT2315, TB-917+**

Mini-Circuits®  
THIS DOCUMENT AND ITS CONTENTS ARE THE PROPERTY OF MINI-CIRCUITS. EXCEPT FOR USE EXPRESSLY GRANTED, IN WRITING, TO ITS VENDORS, VENDEE AND THE UNITED STATES GOVERNMENT, MINI-CIRCUITS RESERVES ALL PROPRIETARY DESIGN, USE, MANUFACTURING AND REPRODUCTION RIGHTS THERETO. THESE CONTENTS SHALL NOT BE USED, DUPLICATED OR DISCLOSED TO ANY OUTSIDE PARTY, IN WHOLE OR IN PART, WITHOUT WRITTEN PERMISSION OF MINI-CIRCUITS.

SIZE A	CODE IDENT 15542	DRAWING NO: 98-PL-452	REV: OR
FILE: 98PL452	SCALE: 7:1	SHEET: 1 OF 1	

# Evaluation Board and Circuit

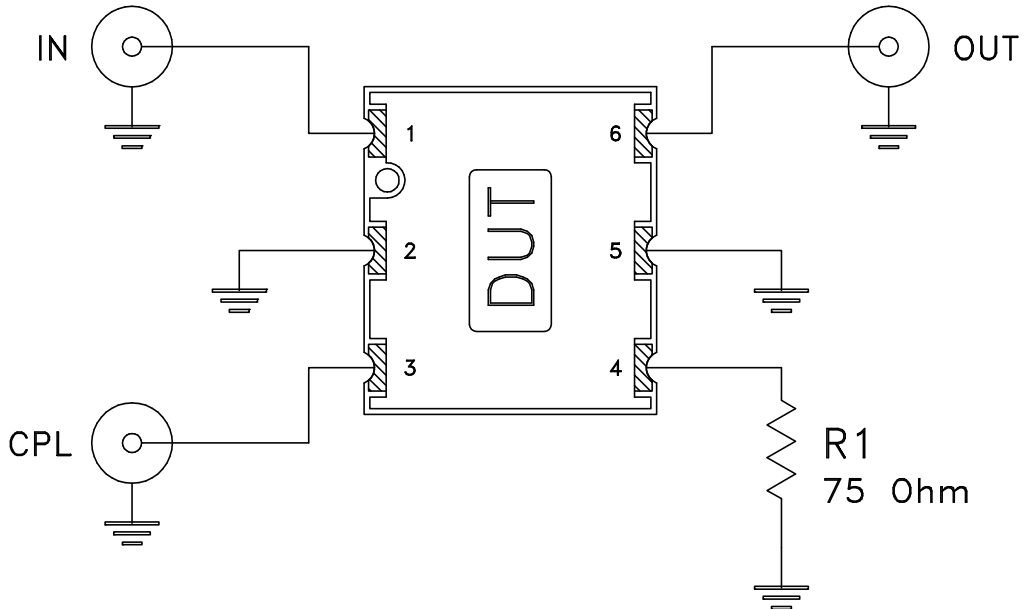
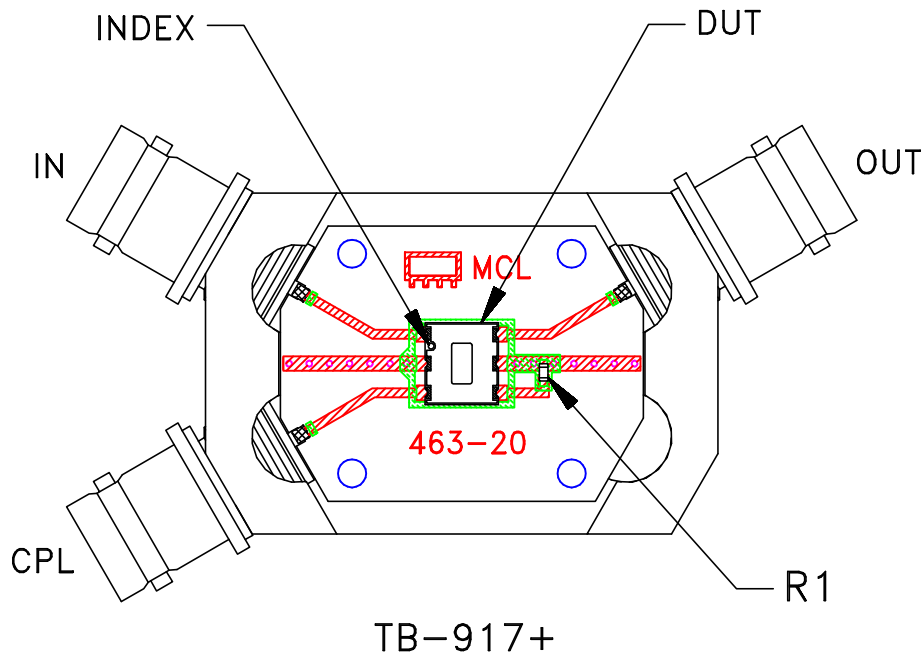

Schematic Diagram

**Notes:**

1. 75 Ohm BNC connectors.
2. PCB Material: R04350 or equivalent,  
Dielectric Constant=3.5, Thickness=.030 inch.

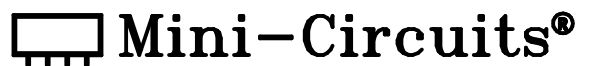

All Mini-Circuits products are manufactured under exacting quality assurance and control standards, and are capable of meeting published specifications after being subjected to any or all of the following physical and environmental test.

Specification	Test/Inspection Condition	Reference/Spec
Operating Temperature	-40° to 85°C Ambient Environment	Individual Model Data Sheet
Storage Temperature	-55° to 100° C Ambient Environment	Individual Model Data Sheet
Humidity	90 to 95% RH, 240 hours, 50°C	MIL-STD-202, Method 103, Condition A, Except 50°C and end-point electrical test done within 12 hours
Thermal Shock	-55° to 100°C, 100 cycles	MIL-STD-202, Method 107, Condition A-3, except +100°C
Solder Reflow Heat	Sn-Pb Eutetic Process: 225°C peak Pb-Free Process 245° - 250°C peak	J-STD-020, Table 4-1, 4-2 and 5-2, Figure 5-1
Solderability	10X Magnification	J-STD-002, 95% Coverage
Vibration (High Frequency)	20g peak, 10-2000 Hz, 12 times in each of three perpendicular directions (total 36)	MIL-STD-202, Method 204, Condition D
Mechanical Shock	50g, 11 ms, 1/2-sine, 18 shocks: 3 each direction, each of 3 axes	MIL-STD-202, Method 213, Condition A
Marking Resistance to Solvents	Isopropyl alcohol + mineral spirits at 25°C; terpene defluxer at 25°C; distilled water + proylene glycol monomethyl ether + monoethanolamine at 63°C to 70°C	MIL-STD-202, Method 215