

# Programmable Attenuator

RCDAT-3000-63W2

50Ω 0 – 63 dB, 2 Watt, 1 dB step 50 to 3000 MHz

## The Big Deal

- High power handling (Up to 2W)
- Wide attenuation range, 63 dB
- Short attenuation transition time (800 ns)
- Compact size, 2.5 x 3.0 x 0.85"
- **USB and Ethernet** control



Software Package

Case Style: MS2065

### Included Accessories

Model No.	Description	Qty.
MUSB-CBL-3+	3.3 ft. USB cable	1

## Applications

- Automated Test Equipment (ATE)
- WiMAX, 3G, 4G, LTE, DVB Fading Simulators
- Laboratory Instrumentation
- Handover system Evaluation
- Power level cycling

### RoHS Compliant

See our web site for RoHS Compliance methodologies and qualifications

## Product Overview

Mini-Circuits' RCDAT-3000-63W2 is a general purpose, single channel programmable attenuator suitable for a wide range of signal level control applications from 50 MHz to 3 GHz. The Attenuator provides 0 to 63 dB attenuation in 1 dB steps. Its unique design maintains linear attenuation change per dB, even at the highest attenuation settings.

The attenuator is housed in a compact and rugged package with SMA female connectors on the bi-directional input and output RF ports, a standard Ethernet port (RJ45) and a USB type Mini-B power and control port.

The attenuator can be controlled via USB or Ethernet (supporting both HTTP and Telnet network protocols). Full software support is provided and can be downloaded from our website any time at <http://www.minicircuits.com/softwaredownload/patt.html>. The package includes our user-friendly GUI application for Windows® and a full API with programming instructions for Windows® and Linux® environments (both 32-bit and 64-bit systems).

## Key Features

Feature	Advantages
USB & Ethernet control	USB HID and Ethernet (HTTP / Telnet) interfaces provide easy compatibility with a wide range of software setups and programming environments
Programmable attenuation sweep and Hop sequences	The RCDAT-3000-63W2 can be programmed with a timed sequence of attenuation settings, to run without any additional external control
63 dB attenuation range.	The RCDAT-3000-63W2 provides high-accuracy attenuation up to 63 dB in 1 dB steps, allowing the user precise level control over a broad attenuation and frequency range.
High linearity	Typical input IP3 of +54 dBm up to 3000 MHz

**Trademarks:** Windows is a registered trademark of Microsoft Corporation in the United States and other countries. Linux is a registered trademark of Linus Torvalds. Mac is a registered trademark of Apple Corporation. Pentium is a registered trademark of Intel Corporation. Neither Mini-Circuits nor the Mini-Circuits RCDAT-series attenuators are affiliated with or endorsed by the owners of the above referenced trademarks.

Mini-Circuits and the Mini-Circuits logo are registered trademarks of Scientific Components Corporation.

Rev. H  
ECO-017131  
EDR-11315PROD  
RCDAT-3000-63W2  
MCIL  
230314  
Page 1 of 8



## Electrical Specifications <sup>1</sup> at 0°C to 50°C

Parameter	Frequency range	Conditions	Min.	Typ.	Max.	Units
Attenuation range	50 - 3000 MHz	1 dB step	0	-	63	dB
Attenuation accuracy	50 - 1000 MHz	@ 1 - 15 dB @ 16 - 63 dB	-	±0.05 ±0.20	±0.35 ±0.8	dB
	1000 - 2000 MHz	@ 1 - 15 dB @ 16 - 48 dB @ 49 - 63 dB	-	±0.30 ±0.30 ±0.65	±1.0 ±1.1 ±1.8	
	2000 - 3000 MHz	@ 1 - 15 dB @ 16 - 48 dB @ 49 - 63 dB	-	±0.45 ±0.55 ±1.05	±1.4 ±1.5 ±2.0	
Insertion Loss	50 - 1000 MHz	@ 0 dB	-	3.3	4.5	dB
	1000 - 2000 MHz		-	4.4	5.5	
	2000 - 3000 MHz		-	5.8	7.5	
Isolation In-Out	50 - 3000 MHz	Note 2	64	-	72	dB
Input operating power <sup>3</sup> (RF In and RF Out ports)	50 - 3000 MHz	@ 0 - 63 dB	-	-	+33	dBm
IP3 Input <sup>4</sup>	50 - 3000 MHz	@ 0 dB setting (P <sub>IN</sub> =+5 dBm)	-	+54	-	dBm
VSWR	50 - 500 MHz	@ 0 - 63 dB	-	1.15	1.65	:1
	500 - 1500 MHz		-	1.20	1.45	
	1500 - 3000 MHz		-	1.40	2.00	
Min Dwell Time <sup>5</sup>	50 - 3000 MHz	High speed mode	-	400	-	µsec
Attenuation Transition Time <sup>6</sup>	50 - 3000 MHz	-	-	800	-	nSec
Supply Voltage	-	via USB port	4.75	5	5.25	V
USB current draw	-	-	-	190	250	mA
Ethernet communication	Supports both Telnet and HTTP protocols over TCP/IP with dynamic(DHCP) or static IP					

<sup>1</sup> Attenuator RF ports are interchangeable, and support simultaneous, bidirectional signal transmission, however the specifications are guaranteed for the RF in and RF out as noted on the label. There may be minor changes in performance when injecting signals to the RF Out port.

<sup>2</sup> Isolation is defined as max attenuation plus insertion loss; this is the path loss through the attenuator when initially powered up. After a brief delay (~0.5 sec typically) the attenuator will revert to a user defined "power-up" state (either max attenuation or a pre-set value).

<sup>3</sup> Total operating input power from both RF In and RF Out out ports. Compression level not noted as it exceeds max safe operating power level.

<sup>4</sup> Tested with 1 MHz span between signals.

<sup>5</sup> Minimum Dwell Time is the time the RCDAT will take to respond to a command to change attenuation states without communication delays. In PC control add communication delays (on the order of msec for USB) to get actual response time.

<sup>6</sup> Attenuation Transition Time is specified as the time between starting to change the attenuation state and settling on the requested attenuation state.

## Absolute Maximum Ratings

Operating Temperature	0°C to 50°C
Case Temperature over ambient	15°C
Storage Temperature	-20°C to 85°C
V <sub>USB</sub> Max.	6V
DC voltage at RF port	16V
Total RF power for RF In & RF Out	+35 dBm

Permanent damage may occur if any of these limits are exceeded. Operating in the range between operating power limits and absolute maximum ratings for extended periods of time may result in reduced life and reliability.

## RCDAT response to communication interrupt

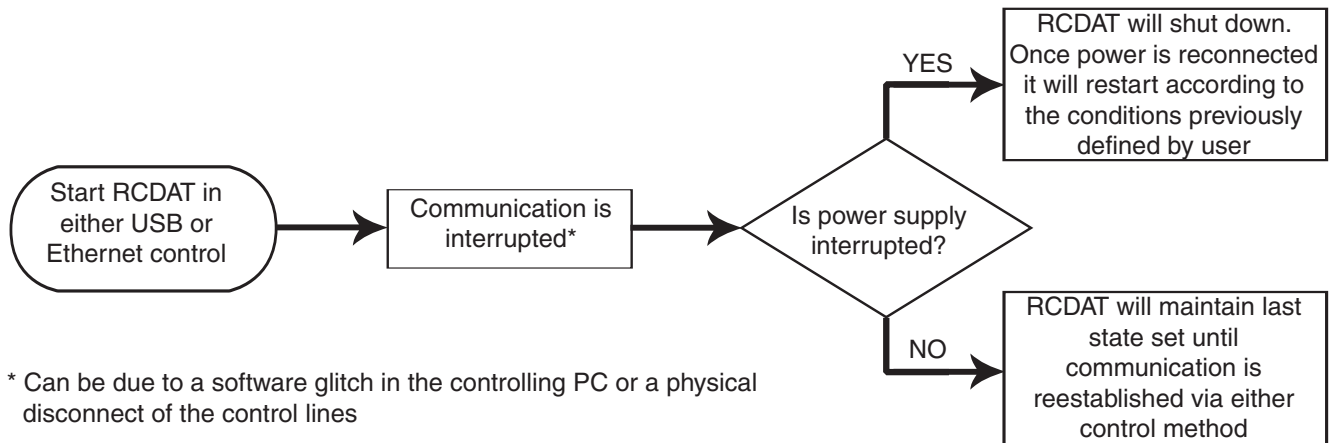

## Block Diagram

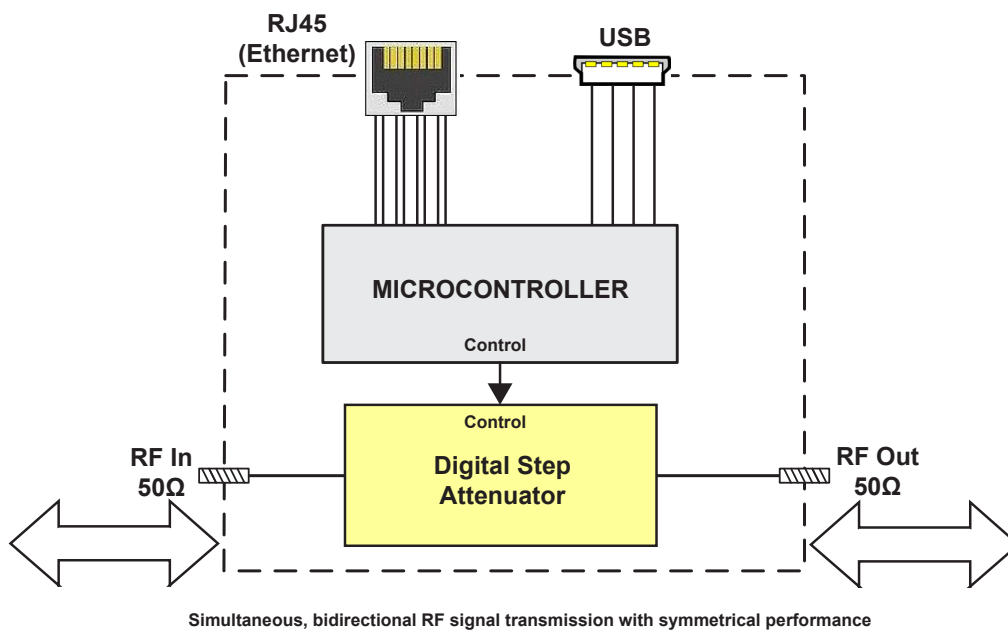

## Connections

RF In	(SMA female)
RF Out	(SMA female)
USB	(USB type Mini-B female)
Network (Ethernet/LAN)	(RJ45 socket)

## Outline Drawing (MS2065)

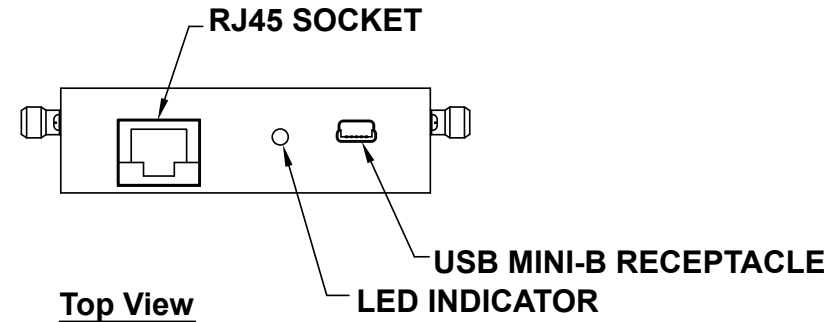

## Connections

RF IN	(SMA female)
RF OUT	(SMA female)
USB	(USB type Mini-B female)
Network (Ethernet/LAN)	(RJ45 socket)

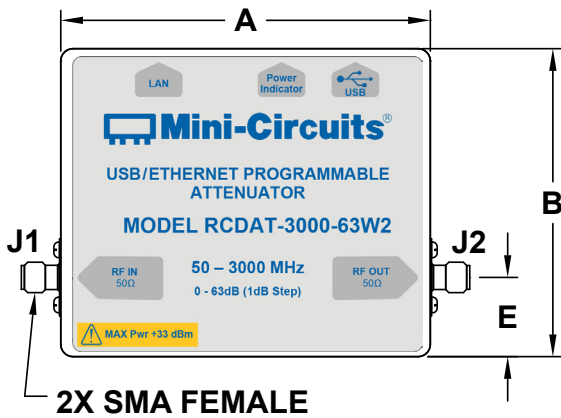

## Bracket Option

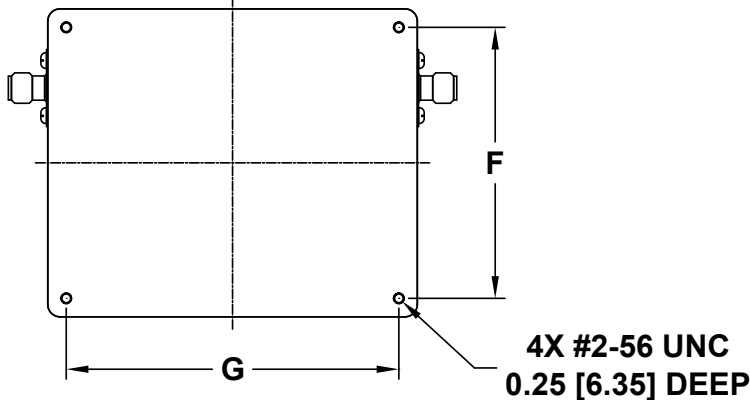
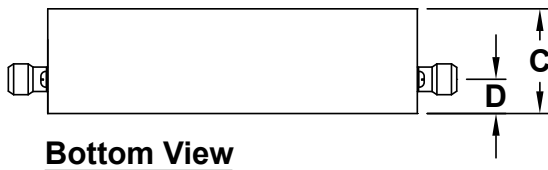
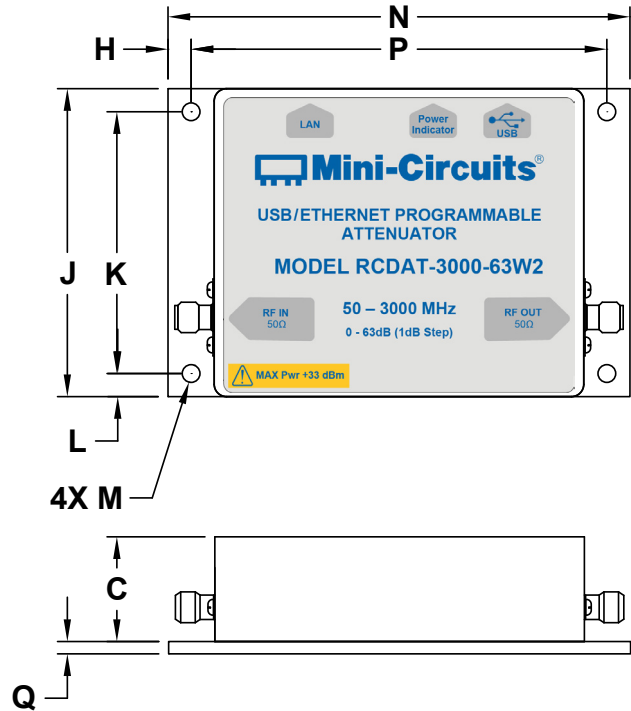

## Instruction for mounting bracket:

1. Tool required: Phillips head screwdriver
2. Mount the bracket over threaded holes on the bottom side with the fasteners provided with the bracket.

## Outline Dimensions (inch/mm)

A	B	C	D	E	F	G	H	J	K	L	M	N	P	Q	WT. GRAMS
3.00	2.50	0.85	0.28	0.64	2.200	2.700	0.188	2.50	2.125	0.188	0.144	3.75	3.375	0.100	200
76.2	63.5	21.6	7.1	16.3	55.88	68.58	4.76	63.5	53.98	4.76	3.66	95.3	85.72	2.54	

## Typical Performance Curves

**Attenuation Accuracy @ +25°C vs. Frequency over Attenuation settings**

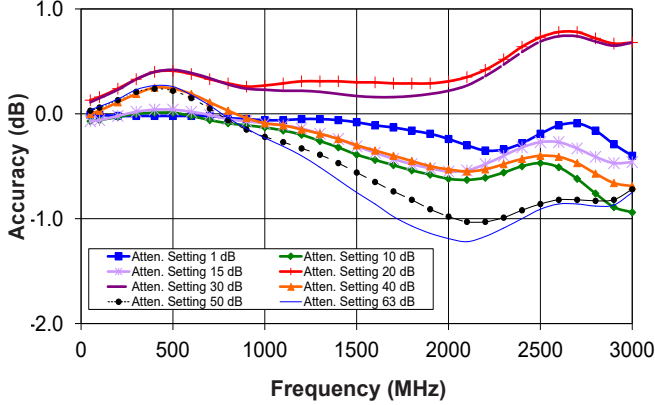

**Attenuation relative to Insertion Loss @ +25°C vs. Frequency over Attenuation settings**

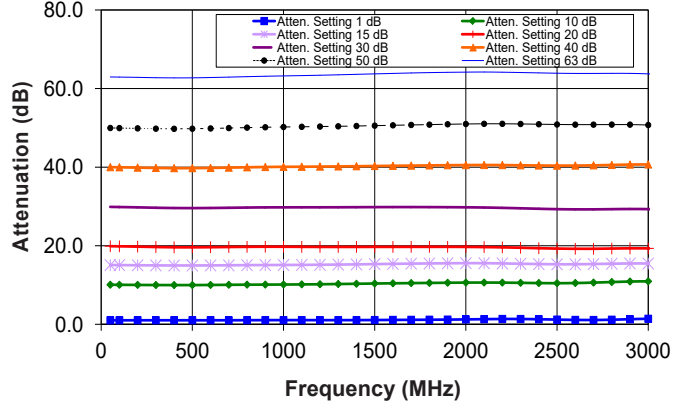

**Attenuation Accuracy @ 0°C vs. Frequency over Attenuation settings**

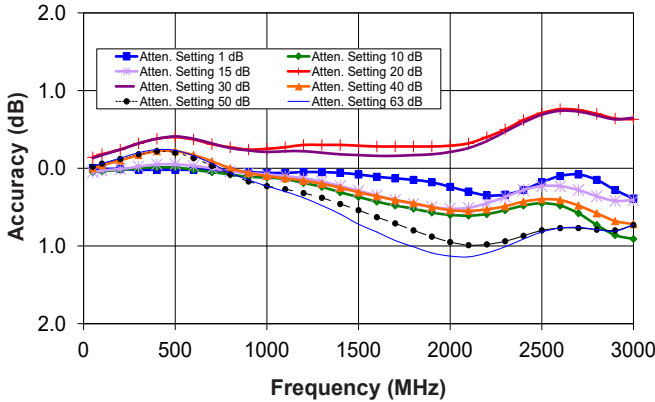

**Attenuation relative to Insertion Loss @ 0°C vs. Frequency over Attenuation settings**

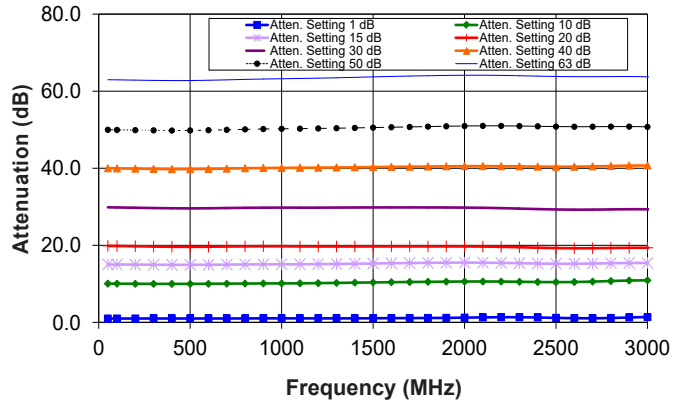

**Attenuation Accuracy @ +50°C vs. Frequency over Attenuation settings**

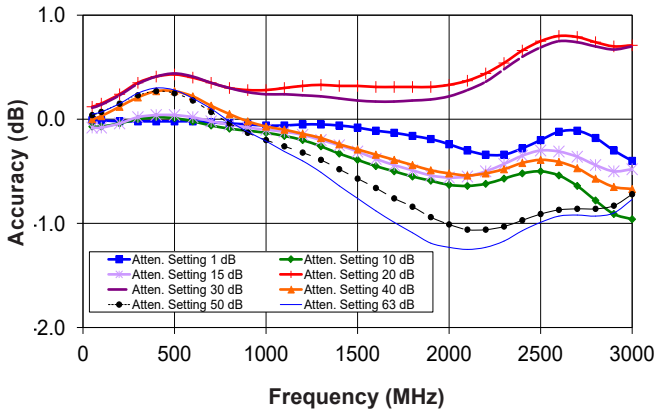

**Attenuation relative to Insertion Loss @ +50°C vs. Frequency over Attenuation settings**

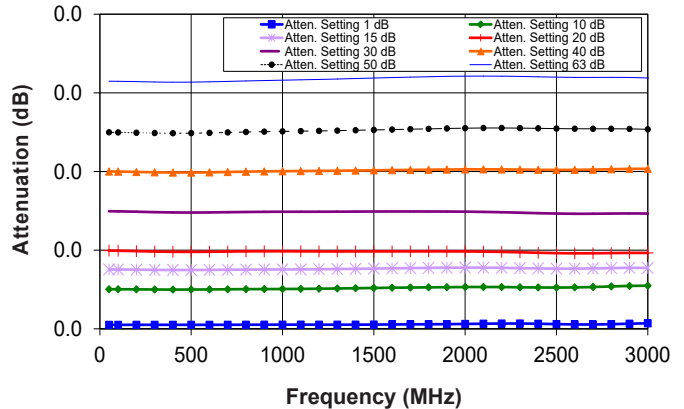

## Typical Performance Curves (Continued)

**Insertion Loss @ Input Power 0dBm vs. Frequency over Temperatures**

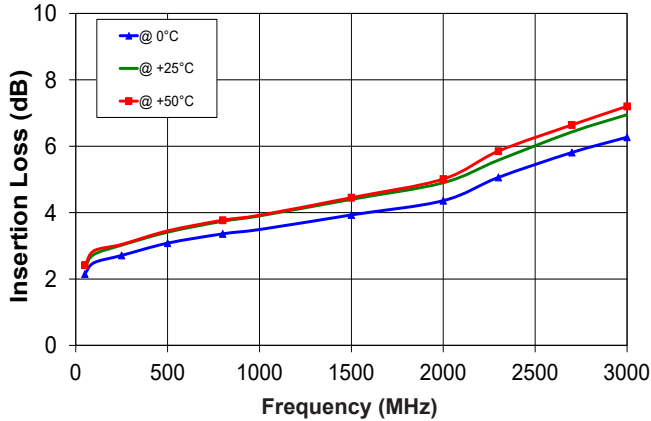

**Insertion Loss @ Input Power +33 dBm vs. Frequency over Temperatures**

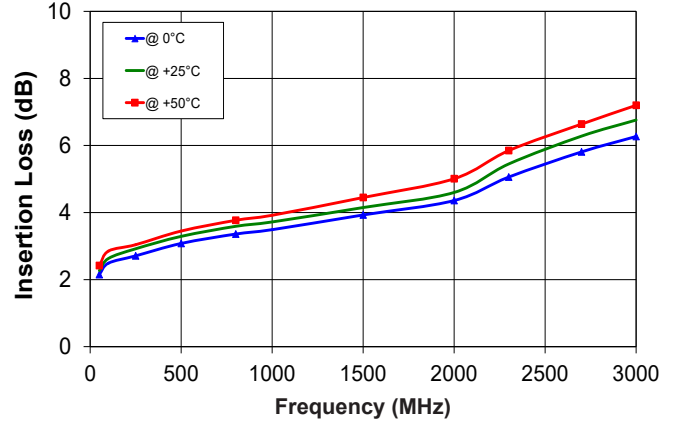

**Output VSWR @ +25°C vs. Frequency over Attenuation settings**

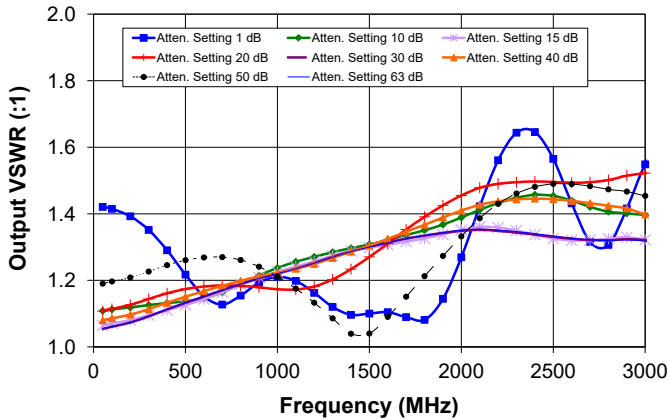

**Input VSWR @ +25°C vs. Frequency over Attenuation settings**

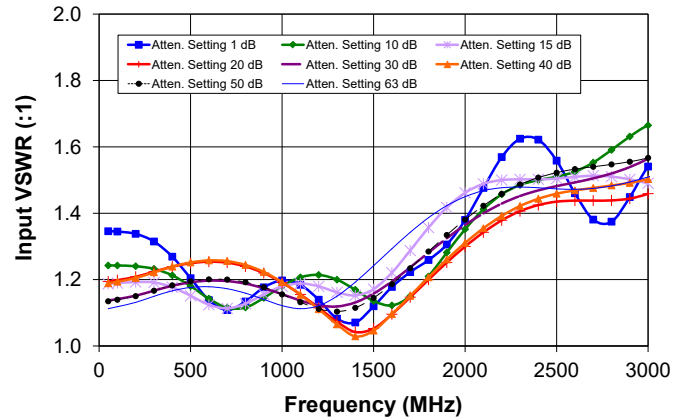

**Input IP3 @ 0dB Attenuation vs. Frequency over Temperatures**

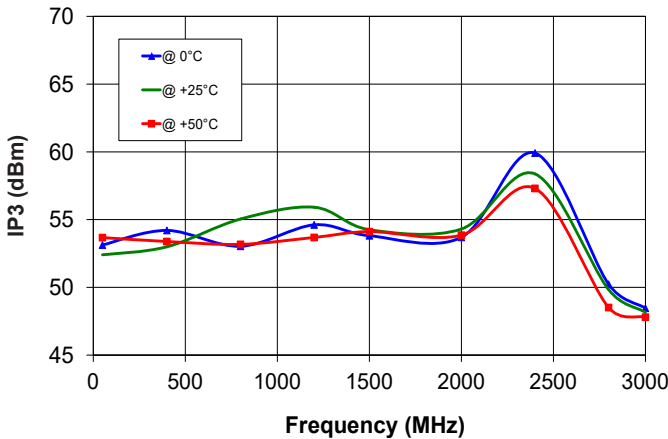

**Typical Attenuation Accuracy vs. Attenuation settings over Temperature**

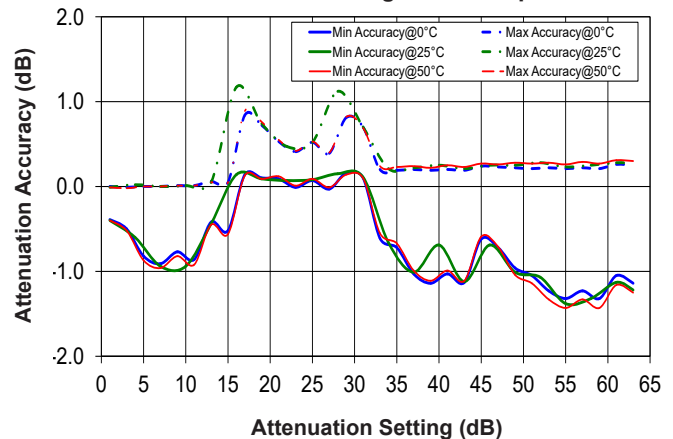

## Software & Documentation Download:

- Mini-Circuits' full software and support package including user guide, Windows GUI, DLL files, programming manual and examples can be downloaded free of charge from <http://www.minicircuits.com/softwaredownload/patt.html>
- Please contact [testsolutions@minicircuits.com](mailto:testsolutions@minicircuits.com) for support

## Minimum System Requirements

Parameter	Requirements	
Interface	USB HID or HTTP Get/Post or Telnet protocols	
System requirements	GUI:	Windows 32 & 64 bit systems from Windows 98 up to Windows 10
	USB API (ActiveX & .Net)	Windows 32 & 64 bit systems with ActiveX or .Net support from Windows 98 up to Windows 10
	USB direct programming support	Linux, Windows systems from Windows 98 up to Windows 10
	HTTP or Telnet	Any computer with a network port and Ethernet-TCP/IP (HTTP or Telnet protocols) support
Hardware	Pentium® II or higher, RAM 256 MB	

## Graphical User Interface (GUI) for Windows

### Key Features:

- Manual attenuation setting
- Sweep and Hop attenuation sequences directed from the PC, or entire sequence loaded into RCDAT.
- Attenuator address configuration and Firmware upgrade
- Attenuation at power up may be set to selected attenuation level or last attenuation state recorded.
- USB, HTTP or Telnet control of RCDAT
- Setting Ethernet configuration

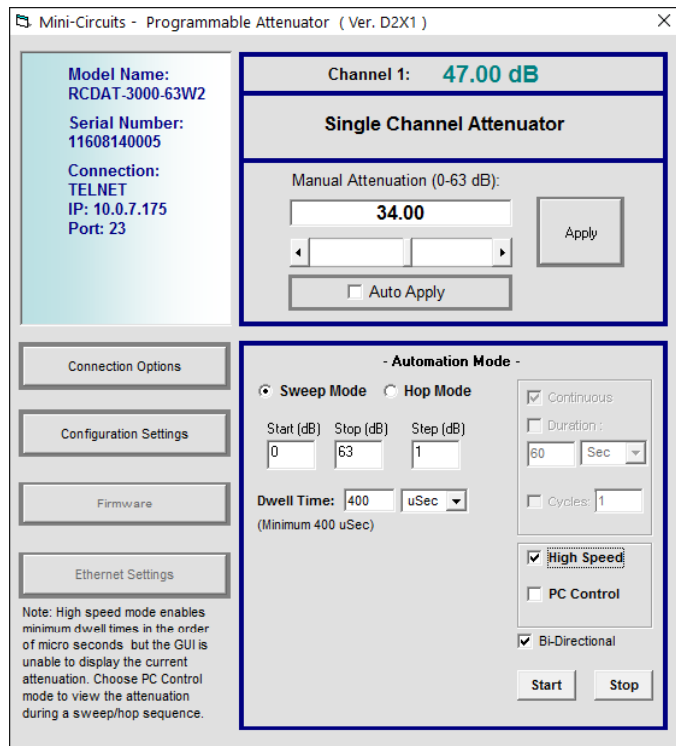

## Application Programming Interface (API)

Programming manual: [https://www.minicircuits.com/softwaredownload/Prog\\_Manual-6-Programmable\\_Attenuator.pdf](https://www.minicircuits.com/softwaredownload/Prog_Manual-6-Programmable_Attenuator.pdf)

### Windows Support:

- API DLL files exposing the full switch functionality
  - ActiveX COM DLL file for creation of 32-bit programs
  - .Net library DLL file for creation of 32 / 64-bit programs
- Supported by most common programming environments (refer to application note [AN-49-001](#) for summary of tested environments)

### Linux Support:

- Full attenuator control in a Linux environment is achieved by way of USB interrupt commands.

## Ordering Information

Model	Description
RCDAT-3000-63W2	USB / Ethernet Programmable Attenuator

Included Accessories	Part No.	Description
	MUSB-CBL-3+	3.3 ft (1.0 m) USB Cable: USB type A(Male) to USB type Mini-B(Male)

Optional Accessories	Description
USB-AC/DC-5 <sup>7,8</sup>	AC/DC 5V <sub>DC</sub> Power Adapter with US, EU, IL, UK, AUS, and China power plugs
MUSB-CBL-3+ (spare)	3.3 ft (1.0 m) USB Cable: USB type A(Male) to USB type Mini-B(Male)
MUSB-CBL-7+	6.6 ft (2.0 m) USB Cable: USB type A(Male) to USB type Mini-B(Male)
CBL-RJ45-MM-5+	5 ft (1.5 m) Ethernet cable: RJ45(Male) to RJ45(Male) Cat 5E cable
BKT-66-02+	Bracket Kit

<sup>7</sup> The USB-AC/DC-5 may be used to provide the 5V<sub>DC</sub> power input via USB port if operating the RCDAT with Ethernet control. Not required if using USB control.

<sup>8</sup> Power plugs for other countries are also available, Plugs for other countries are also available, if you need a power plug for a country not listed please contact [testsolutions@minicircuits.com](mailto:testsolutions@minicircuits.com)

## Additional Notes

- A. Performance and quality attributes and conditions not expressly stated in this specification document are intended to be excluded and do not form a part of this specification document.
- B. Electrical specifications and performance data contained in this specification document are based on Mini-Circuit's applicable established test performance criteria and measurement instructions.
- C. The parts covered by this specification document are subject to Mini-Circuits standard limited warranty and terms and conditions (collectively, "Standard Terms"); Purchasers of this part are entitled to the rights and benefits contained therein. For a full statement of the Standard Terms and the exclusive rights and remedies thereunder, please visit Mini-Circuits' website at [www.minicircuits.com/MCLStore/terms.jsp](http://www.minicircuits.com/MCLStore/terms.jsp)





# Programmable Atten.

# RCDAT-3000-63W2

## Typical Performance Data @ 0°C

FREQUENCY (MHz)	Attenuation relative to Insertion Loss (dB)							
	1 dB	10 dB	15 dB	20 dB	30 dB	40 dB	50 dB	63 dB
50	1.00	10.05	15.05	19.86	29.87	40.00	49.98	62.97
75	1.01	10.05	15.04	19.85	29.85	39.99	49.97	62.95
100	1.01	10.04	15.03	19.82	29.83	39.96	49.94	62.94
200	1.01	10.02	15.01	19.76	29.76	39.90	49.88	62.87
300	1.02	10.00	14.98	19.68	29.68	39.83	49.82	62.80
500	1.02	9.99	14.95	19.60	29.59	39.78	49.80	62.77
700	1.02	10.05	15.00	19.69	29.68	39.91	49.97	62.94
900	1.05	10.11	15.06	19.76	29.77	40.06	50.17	63.15
1000	1.06	10.12	15.08	19.75	29.79	40.10	50.23	63.23
1200	1.05	10.19	15.13	19.70	29.78	40.16	50.32	63.38
1350	1.05	10.28	15.20	19.70	29.81	40.22	50.42	63.54
1500	1.08	10.37	15.29	19.71	29.83	40.31	50.54	63.72
1700	1.13	10.48	15.41	19.72	29.84	40.41	50.71	63.93
1900	1.18	10.57	15.50	19.72	29.82	40.50	50.88	64.09
2100	1.30	10.61	15.51	19.68	29.74	40.55	50.99	64.14
2300	1.34	10.54	15.37	19.50	29.53	40.49	50.94	64.01
2500	1.18	10.45	15.23	19.29	29.31	40.40	50.80	63.82
2700	1.08	10.58	15.28	19.25	29.27	40.48	50.77	63.76
2900	1.28	10.86	15.42	19.36	29.37	40.68	50.80	63.81
3000	1.39	10.91	15.41	19.37	29.35	40.72	50.73	63.73

FREQUENCY (MHz)	Attenuation accuracy relative to nominal attenuation setting (dB)							
	1 dB	10 dB	15 dB	20 dB	30 dB	40 dB	50 dB	63 dB
50	0.00	-0.05	-0.05	0.14	0.13	0.00	0.02	0.03
75	-0.01	-0.05	-0.04	0.15	0.15	0.01	0.03	0.05
100	-0.01	-0.04	-0.03	0.18	0.17	0.04	0.06	0.06
200	-0.01	-0.02	-0.01	0.24	0.24	0.10	0.12	0.13
300	-0.02	0.00	0.02	0.32	0.32	0.17	0.18	0.20
500	-0.02	0.01	0.05	0.40	0.41	0.22	0.20	0.23
700	-0.02	-0.05	0.00	0.31	0.32	0.09	0.03	0.06
900	-0.05	-0.11	-0.06	0.24	0.23	-0.06	-0.17	-0.15
1000	-0.06	-0.12	-0.08	0.25	0.21	-0.10	-0.23	-0.23
1200	-0.05	-0.19	-0.13	0.30	0.22	-0.16	-0.32	-0.38
1350	-0.05	-0.28	-0.20	0.30	0.19	-0.22	-0.42	-0.54
1500	-0.08	-0.37	-0.29	0.29	0.17	-0.31	-0.54	-0.72
1700	-0.13	-0.48	-0.41	0.28	0.16	-0.41	-0.71	-0.93
1900	-0.18	-0.57	-0.50	0.28	0.18	-0.50	-0.88	-1.09
2100	-0.30	-0.61	-0.51	0.32	0.26	-0.55	-0.99	-1.14
2300	-0.34	-0.54	-0.37	0.50	0.47	-0.49	-0.94	-1.01
2500	-0.18	-0.45	-0.23	0.71	0.69	-0.40	-0.80	-0.82
2700	-0.08	-0.58	-0.28	0.75	0.73	-0.48	-0.77	-0.76
2900	-0.28	-0.86	-0.42	0.64	0.63	-0.68	-0.80	-0.81
3000	-0.39	-0.91	-0.41	0.63	0.65	-0.72	-0.73	-0.73

**Notes**

- A. Performance and quality attributes and conditions not expressly stated in this specification document are intended to be excluded and do not form a part of this specification document.
- B. Electrical specifications and performance data contained in this specification document are based on Mini-Circuit's applicable established test performance criteria and measurement instructions.
- C. The parts covered by this specification document are subject to Mini-Circuits standard limited warranty and terms and conditions (collectively, "Standard Terms"); Purchasers of this part are entitled to the rights and benefits contained therein. For a full statement of the Standard Terms and the exclusive rights and remedies thereunder, please visit Mini-Circuits' website at [www.minicircuits.com/MCLStore/terms.jsp](http://www.minicircuits.com/MCLStore/terms.jsp)



# Programmable Atten.

# RCDAT-3000-63W2

## Typical Performance Data @ 0°C

FREQUENCY (MHz)	IP3 (dBm)	Insertion Loss @P <sub>IN</sub> =0 dBm (dB)	Insertion Loss @P <sub>IN</sub> =+33 dBm (dB)
50	53.12	2.15	2.18
75	53.11	2.32	2.38
100	53.10	2.49	2.58
200	53.28	-	-
300	53.76	2.78	2.80
500	53.23	3.08	3.10
700	53.36	-	-
900	54.63	3.43	3.43
1000	55.59	3.49	3.49
1200	54.61	-	-
1350	53.88	3.80	3.83
1500	53.81	3.93	3.97
1700	55.09	-	-
1900	53.33	4.27	4.32
2100	53.37	-	-
2300	55.39	5.06	5.34
2500	57.15	5.44	5.69
2700	52.29	5.81	6.04
2900	49.27	-	-
3000	48.46	6.27	6.57

### Notes

- A. Performance and quality attributes and conditions not expressly stated in this specification document are intended to be excluded and do not form a part of this specification document.  
B. Electrical specifications and performance data contained in this specification document are based on Mini-Circuit's applicable established test performance criteria and measurement instructions.  
C. The parts covered by this specification document are subject to Mini-Circuit's standard limited warranty and terms and conditions (collectively, "Standard Terms"); Purchasers of this part are entitled to the rights and benefits contained therein. For a full statement of the Standard Terms and the exclusive rights and remedies thereunder, please visit Mini-Circuit's website at [www.minicircuits.com/MCLStore/terms.jsp](http://www.minicircuits.com/MCLStore/terms.jsp)

# Programmable Atten.

# RCDAT-3000-63W2

## Typical Performance Data @ +25°C

FREQUENCY (MHz)	Attenuation relative to Insertion Loss (dB)							
	1 dB	10 dB	15 dB	20 dB	30 dB	40 dB	50 dB	63 dB
50	1.00	10.07	15.07	19.87	29.89	40.00	49.97	62.96
75	1.01	10.07	15.07	19.86	29.87	39.99	49.96	62.96
100	1.01	10.06	15.06	19.84	29.85	39.97	49.94	62.93
200	1.02	10.03	15.02	19.76	29.77	39.89	49.87	62.86
300	1.02	10.00	14.98	19.67	29.67	39.81	49.79	62.77
500	1.02	9.99	14.96	19.59	29.58	39.76	49.78	62.74
700	1.02	10.06	15.01	19.67	29.66	39.89	49.95	62.92
900	1.05	10.11	15.07	19.74	29.76	40.04	50.15	63.14
1000	1.06	10.13	15.09	19.73	29.77	40.09	50.22	63.23
1200	1.05	10.20	15.14	19.69	29.78	40.15	50.33	63.40
1350	1.05	10.29	15.21	19.69	29.80	40.22	50.43	63.56
1500	1.08	10.39	15.31	19.70	29.83	40.30	50.56	63.75
1700	1.13	10.49	15.43	19.71	29.84	40.40	50.74	63.98
1900	1.19	10.58	15.52	19.71	29.81	40.50	50.91	64.14
2100	1.30	10.63	15.54	19.65	29.73	40.55	51.03	64.22
2300	1.34	10.56	15.40	19.48	29.53	40.48	50.99	64.09
2500	1.19	10.47	15.27	19.27	29.31	40.40	50.86	63.91
2700	1.09	10.62	15.33	19.22	29.26	40.47	50.82	63.86
2900	1.29	10.89	15.47	19.33	29.35	40.66	50.82	63.87
3000	1.40	10.94	15.46	19.32	29.32	40.69	50.72	63.75

FREQUENCY (MHz)	Attenuation accuracy relative to nominal attenuation setting (dB)							
	1 dB	10 dB	15 dB	20 dB	30 dB	40 dB	50 dB	63 dB
50	0.00	-0.07	-0.07	0.13	0.11	0.00	0.03	0.04
75	-0.01	-0.07	-0.07	0.14	0.13	0.01	0.04	0.04
100	-0.01	-0.06	-0.06	0.16	0.15	0.03	0.06	0.07
200	-0.02	-0.03	-0.02	0.24	0.23	0.11	0.13	0.14
300	-0.02	0.00	0.02	0.33	0.33	0.19	0.21	0.23
500	-0.02	0.01	0.04	0.41	0.42	0.24	0.22	0.26
700	-0.02	-0.06	-0.01	0.33	0.34	0.11	0.05	0.08
900	-0.05	-0.11	-0.07	0.26	0.24	-0.04	-0.15	-0.14
1000	-0.06	-0.13	-0.09	0.27	0.23	-0.09	-0.22	-0.23
1200	-0.05	-0.20	-0.14	0.31	0.22	-0.15	-0.33	-0.40
1350	-0.05	-0.29	-0.21	0.31	0.20	-0.22	-0.43	-0.56
1500	-0.08	-0.39	-0.31	0.30	0.17	-0.30	-0.56	-0.75
1700	-0.13	-0.49	-0.43	0.29	0.16	-0.40	-0.74	-0.98
1900	-0.19	-0.58	-0.52	0.29	0.19	-0.50	-0.91	-1.14
2100	-0.30	-0.63	-0.54	0.35	0.27	-0.55	-1.03	-1.22
2300	-0.34	-0.56	-0.40	0.52	0.47	-0.48	-0.99	-1.09
2500	-0.19	-0.47	-0.27	0.73	0.69	-0.40	-0.86	-0.91
2700	-0.09	-0.62	-0.33	0.78	0.74	-0.47	-0.82	-0.86
2900	-0.29	-0.89	-0.47	0.67	0.65	-0.66	-0.82	-0.87
3000	-0.40	-0.94	-0.46	0.68	0.68	-0.69	-0.72	-0.75

**Notes**

- A. Performance and quality attributes and conditions not expressly stated in this specification document are intended to be excluded and do not form a part of this specification document.
- B. Electrical specifications and performance data contained in this specification document are based on Mini-Circuit's applicable established test performance criteria and measurement instructions.
- C. The parts covered by this specification document are subject to Mini-Circuits standard limited warranty and terms and conditions (collectively, "Standard Terms"); Purchasers of this part are entitled to the rights and benefits contained therein. For a full statement of the Standard Terms and the exclusive rights and remedies thereunder, please visit Mini-Circuits' website at [www.minicircuits.com/MCLStore/terms.jsp](http://www.minicircuits.com/MCLStore/terms.jsp)



# Programmable Atten.

# RCDAT-3000-63W2

## Typical Performance Data @ +25°C

FREQUENCY (MHz)	Input VSWR (:1)							
	1 dB	10 dB	15 dB	20 dB	30 dB	40 dB	50 dB	63 dB
50	1.35	1.24	1.19	1.19	1.14	1.19	1.13	1.11
75	1.35	1.24	1.19	1.20	1.14	1.19	1.14	1.11
100	1.34	1.24	1.19	1.20	1.14	1.19	1.14	1.12
200	1.34	1.24	1.19	1.21	1.15	1.20	1.15	1.13
300	1.31	1.23	1.19	1.22	1.17	1.22	1.17	1.15
500	1.20	1.18	1.15	1.25	1.19	1.25	1.19	1.18
700	1.11	1.12	1.11	1.25	1.20	1.26	1.20	1.17
900	1.18	1.14	1.16	1.22	1.17	1.22	1.18	1.14
1000	1.20	1.18	1.18	1.19	1.16	1.19	1.16	1.12
1200	1.14	1.21	1.18	1.12	1.12	1.11	1.11	1.12
1350	1.07	1.19	1.15	1.05	1.12	1.04	1.11	1.17
1500	1.12	1.14	1.17	1.05	1.16	1.05	1.14	1.24
1700	1.22	1.15	1.29	1.15	1.24	1.15	1.23	1.34
1900	1.31	1.28	1.42	1.25	1.32	1.26	1.33	1.42
2100	1.48	1.41	1.49	1.34	1.40	1.35	1.42	1.47
2300	1.62	1.49	1.50	1.41	1.45	1.42	1.49	1.48
2500	1.56	1.51	1.50	1.44	1.48	1.46	1.52	1.47
2700	1.38	1.55	1.51	1.44	1.51	1.48	1.54	1.47
2900	1.45	1.63	1.50	1.44	1.54	1.49	1.56	1.49
3000	1.54	1.66	1.49	1.46	1.56	1.50	1.57	1.51

FREQUENCY (MHz)	Output VSWR (:1)							
	1 dB	10 dB	15 dB	20 dB	30 dB	40 dB	50 dB	63 dB
50	1.42	1.11	1.06	1.11	1.05	1.08	1.19	1.05
75	1.42	1.11	1.07	1.11	1.06	1.08	1.19	1.06
100	1.41	1.11	1.07	1.11	1.06	1.09	1.20	1.06
200	1.39	1.12	1.08	1.13	1.07	1.10	1.21	1.07
300	1.35	1.13	1.09	1.14	1.09	1.11	1.23	1.09
500	1.22	1.14	1.13	1.17	1.13	1.15	1.26	1.13
700	1.13	1.16	1.16	1.18	1.17	1.18	1.27	1.17
900	1.19	1.21	1.21	1.18	1.21	1.21	1.24	1.21
1000	1.21	1.24	1.23	1.17	1.22	1.22	1.21	1.22
1200	1.16	1.27	1.26	1.18	1.25	1.25	1.13	1.25
1350	1.10	1.29	1.28	1.22	1.28	1.28	1.06	1.28
1500	1.10	1.31	1.30	1.27	1.30	1.30	1.04	1.30
1700	1.09	1.34	1.32	1.35	1.33	1.35	1.15	1.33
1900	1.14	1.37	1.34	1.43	1.34	1.39	1.27	1.34
2100	1.42	1.41	1.36	1.48	1.35	1.43	1.39	1.35
2300	1.64	1.45	1.35	1.49	1.34	1.44	1.46	1.35
2500	1.57	1.45	1.33	1.50	1.33	1.44	1.49	1.33
2700	1.32	1.42	1.32	1.49	1.32	1.43	1.48	1.32
2900	1.42	1.40	1.33	1.51	1.32	1.42	1.47	1.32
3000	1.55	1.40	1.32	1.52	1.32	1.40	1.45	1.32

**Notes**

- A. Performance and quality attributes and conditions not expressly stated in this specification document are intended to be excluded and do not form a part of this specification document.
- B. Electrical specifications and performance data contained in this specification document are based on Mini-Circuit's applicable established test performance criteria and measurement instructions.
- C. The parts covered by this specification document are subject to Mini-Circuit's standard limited warranty and terms and conditions (collectively, "Standard Terms"); Purchasers of this part are entitled to the rights and benefits contained therein. For a full statement of the Standard Terms and the exclusive rights and remedies thereunder, please visit Mini-Circuit's website at [www.minicircuits.com/MCLStore/terms.jsp](http://www.minicircuits.com/MCLStore/terms.jsp)



# Programmable Atten.

# RCDAT-3000-63W2

## Typical Performance Data @ +25°C

FREQUENCY (MHz)	IP3 (dBm)	Insertion Loss @P <sub>IN</sub> =0 dBm (dB)	Insertion Loss @P <sub>IN</sub> =+33 dBm (dB)
50	52.40	2.27	2.30
75	52.67	2.45	2.51
100	52.93	2.63	2.71
200	52.69	-	-
300	52.52	2.99	3.00
500	52.49	3.29	3.31
700	49.94	-	-
900	57.65	3.66	3.68
1000	58.41	3.72	3.74
1200	55.91	-	-
1350	54.79	4.02	4.08
1500	54.25	4.15	4.22
1700	55.48	-	-
1900	53.70	4.51	4.61
2100	55.11	-	-
2300	57.59	5.45	5.61
2500	53.99	5.87	6.00
2700	51.15	6.28	6.39
2900	48.59	-	-
3000	48.16	6.76	6.92

### Notes

- A. Performance and quality attributes and conditions not expressly stated in this specification document are intended to be excluded and do not form a part of this specification document.
- B. Electrical specifications and performance data contained in this specification document are based on Mini-Circuit's applicable established test performance criteria and measurement instructions.
- C. The parts covered by this specification document are subject to Mini-Circuits standard limited warranty and terms and conditions (collectively, "Standard Terms"); Purchasers of this part are entitled to the rights and benefits contained therein. For a full statement of the Standard Terms and the exclusive rights and remedies thereunder, please visit Mini-Circuits' website at [www.minicircuits.com/MCLStore/terms.jsp](http://www.minicircuits.com/MCLStore/terms.jsp)



# Programmable Atten.

# RCDAT-3000-63W2

## Typical Performance Data @ 50°C

FREQUENCY (MHz)	Attenuation relative to Insertion Loss (dB)							
	1 dB	10 dB	15 dB	20 dB	30 dB	40 dB	50 dB	63 dB
50	1.00	10.07	15.08	19.88	29.89	40.00	49.96	62.95
75	1.01	10.07	15.08	19.87	29.88	39.99	49.95	62.95
100	1.01	10.07	15.08	19.85	29.86	39.97	49.93	62.93
200	1.02	10.04	15.04	19.76	29.77	39.88	49.85	62.85
300	1.02	10.00	14.98	19.65	29.66	39.79	49.77	62.75
500	1.02	9.99	14.96	19.57	29.56	39.73	49.75	62.72
700	1.03	10.06	15.02	19.65	29.65	39.87	49.93	62.90
900	1.05	10.11	15.08	19.72	29.74	40.02	50.13	63.12
1000	1.06	10.13	15.10	19.72	29.76	40.07	50.20	63.21
1200	1.05	10.20	15.15	19.68	29.77	40.14	50.32	63.40
1350	1.06	10.29	15.22	19.67	29.79	40.21	50.44	63.57
1500	1.08	10.39	15.31	19.68	29.82	40.29	50.57	63.76
1700	1.13	10.50	15.44	19.69	29.83	40.39	50.76	63.99
1900	1.19	10.59	15.54	19.69	29.81	40.49	50.94	64.19
2100	1.30	10.64	15.55	19.63	29.72	40.54	51.06	64.25
2300	1.34	10.57	15.43	19.46	29.52	40.48	51.03	64.17
2500	1.20	10.50	15.30	19.25	29.31	40.39	50.91	63.99
2700	1.11	10.64	15.36	19.21	29.26	40.47	50.86	63.92
2900	1.30	10.91	15.50	19.30	29.33	40.65	50.83	63.90
3000	1.40	10.96	15.48	19.29	29.30	40.67	50.72	63.77

FREQUENCY (MHz)	Attenuation accuracy relative to nominal attenuation setting (dB)							
	1 dB	10 dB	15 dB	20 dB	30 dB	40 dB	50 dB	63 dB
50	0.00	-0.07	-0.08	0.12	0.11	0.00	0.04	0.05
75	-0.01	-0.07	-0.08	0.13	0.12	0.01	0.05	0.05
100	-0.01	-0.07	-0.08	0.15	0.14	0.03	0.07	0.07
200	-0.02	-0.04	-0.04	0.24	0.23	0.12	0.15	0.15
300	-0.02	0.00	0.02	0.35	0.34	0.21	0.23	0.25
500	-0.02	0.01	0.04	0.43	0.44	0.27	0.25	0.28
700	-0.03	-0.06	-0.02	0.35	0.35	0.13	0.07	0.10
900	-0.05	-0.11	-0.08	0.28	0.26	-0.02	-0.13	-0.12
1000	-0.06	-0.13	-0.10	0.28	0.24	-0.07	-0.20	-0.21
1200	-0.05	-0.20	-0.15	0.32	0.23	-0.14	-0.32	-0.40
1350	-0.06	-0.29	-0.22	0.33	0.21	-0.21	-0.44	-0.57
1500	-0.08	-0.39	-0.31	0.32	0.18	-0.29	-0.57	-0.76
1700	-0.13	-0.50	-0.44	0.31	0.17	-0.39	-0.76	-0.99
1900	-0.19	-0.59	-0.54	0.31	0.19	-0.49	-0.94	-1.19
2100	-0.30	-0.64	-0.55	0.37	0.28	-0.54	-1.06	-1.25
2300	-0.34	-0.57	-0.43	0.54	0.48	-0.48	-1.03	-1.17
2500	-0.20	-0.50	-0.30	0.75	0.69	-0.39	-0.91	-0.99
2700	-0.11	-0.64	-0.36	0.79	0.74	-0.47	-0.86	-0.92
2900	-0.30	-0.91	-0.50	0.70	0.67	-0.65	-0.83	-0.90
3000	-0.40	-0.96	-0.48	0.71	0.70	-0.67	-0.72	-0.77

**Notes**

- A. Performance and quality attributes and conditions not expressly stated in this specification document are intended to be excluded and do not form a part of this specification document.
- B. Electrical specifications and performance data contained in this specification document are based on Mini-Circuit's applicable established test performance criteria and measurement instructions.
- C. The parts covered by this specification document are subject to Mini-Circuits standard limited warranty and terms and conditions (collectively, "Standard Terms"). Purchasers of this part are entitled to the rights and benefits contained therein. For a full statement of the Standard Terms and the exclusive rights and remedies thereunder, please visit Mini-Circuits' website at [www.minicircuits.com/MCLStore/terms.jsp](http://www.minicircuits.com/MCLStore/terms.jsp)



# Programmable Atten.

# RCDAT-3000-63W2

## Typical Performance Data @ 50°C

FREQUENCY (MHz)	IP3 (dBm)	Insertion Loss @P <sub>IN</sub> =0 dBm (dB)	Insertion Loss @P <sub>IN</sub> =+33 dBm (dB)
50	53.67	2.37	2.42
75	53.62	2.56	2.64
100	53.57	2.74	2.85
200	53.11	-	-
300	52.97	3.10	3.12
500	52.11	3.41	3.45
700	53.28	-	-
900	54.88	3.82	3.85
1000	55.96	3.90	3.92
1200	53.68	-	-
1350	53.95	4.25	4.29
1500	54.11	4.40	4.45
1700	54.38	-	-
1900	52.52	4.80	4.90
2100	53.12	-	-
2300	56.22	5.58	5.85
2500	53.99	6.01	6.25
2700	50.16	6.43	6.64
2900	48.06	-	-
3000	47.80	6.95	7.20

### Notes

- A. Performance and quality attributes and conditions not expressly stated in this specification document are intended to be excluded and do not form a part of this specification document.
- B. Electrical specifications and performance data contained in this specification document are based on Mini-Circuit's applicable established test performance criteria and measurement instructions.
- C. The parts covered by this specification document are subject to Mini-Circuits standard limited warranty and terms and conditions (collectively, "Standard Terms"). Purchasers of this part are entitled to the rights and benefits contained therein. For a full statement of the Standard Terms and the exclusive rights and remedies thereunder, please visit Mini-Circuits' website at [www.minicircuits.com/MCLStore/terms.jsp](http://www.minicircuits.com/MCLStore/terms.jsp)



# Programmable Attenuator

# RCDAT-3000-63W2

## Typical Performance Curves @ 0°C

**Attenuation Accuracy vs. Frequency over Attenuation settings**

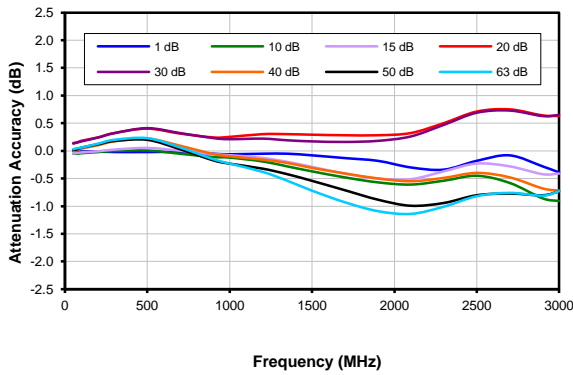

**Attenuation relative to I.L. vs. Frequency over Attenuation settings**

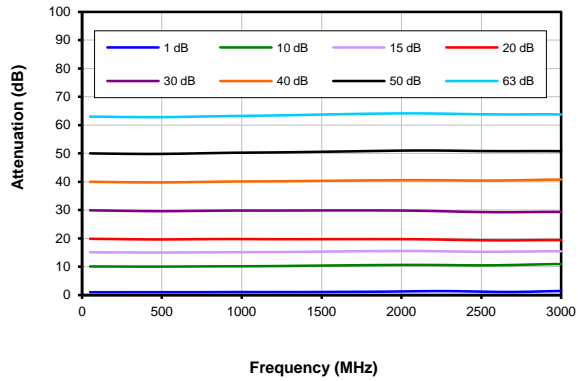

**IP3 @ 0dB Attenuation**

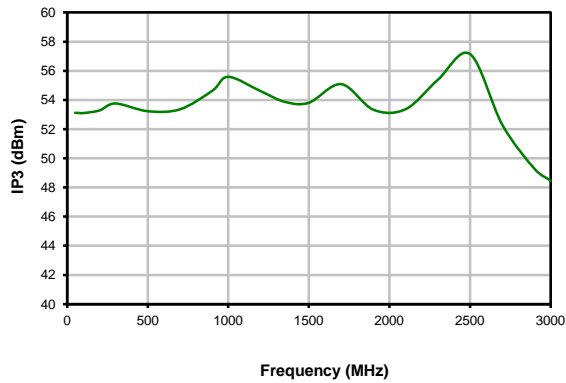

**Insertion Loss**

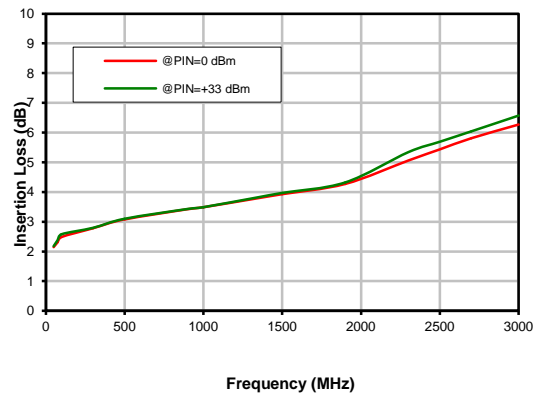

**Notes**

- A. Performance and quality attributes and conditions not expressly stated in this specification document are intended to be excluded and do not form a part of this specification document.
- B. Electrical specifications and performance data contained in this specification document are based on Mini-Circuit's applicable established test performance criteria and measurement instructions.
- C. The parts covered by this specification document are subject to Mini-Circuits standard limited warranty and terms and conditions (collectively, "Standard Terms"); Purchasers of this part are entitled to the rights and benefits contained therein. For a full statement of the Standard Terms and the exclusive rights and remedies thereunder, please visit Mini-Circuits' website at [www.minicircuits.com/MCLStore/terms.jsp](http://www.minicircuits.com/MCLStore/terms.jsp)





# Programmable Attenuator

# RCDAT-3000-63W2

## Typical Performance Curves @ +25°C

**Attenuation Accuracy vs. Frequency over Attenuation settings**

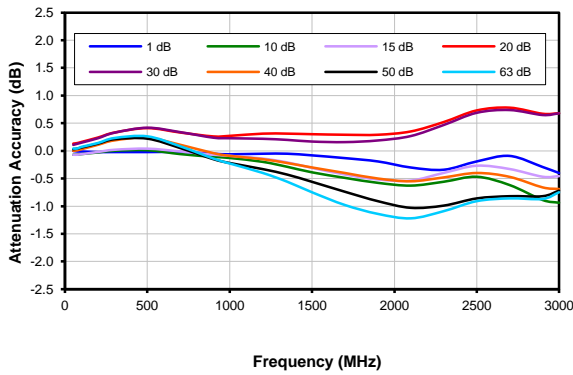

**Attenuation relative to I.L. vs. Frequency over Attenuation settings**

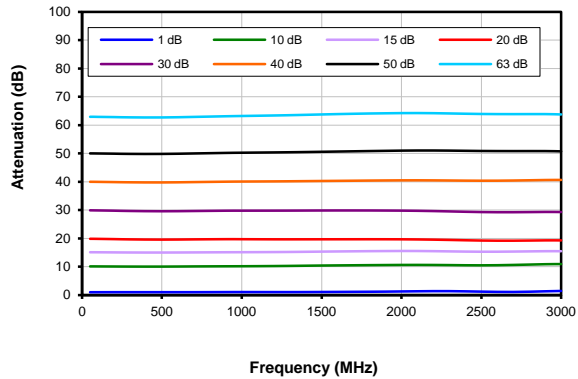

**Input VSWR vs. Frequency over Attenuation settings**

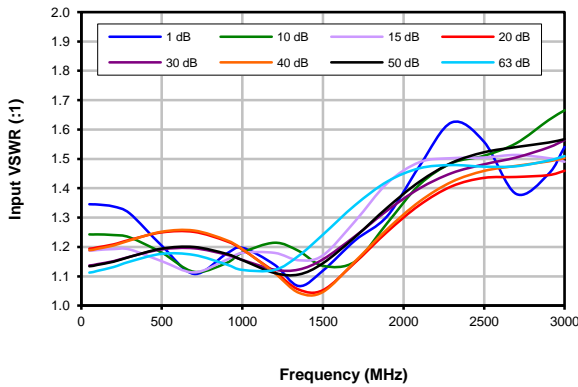

**Output VSWR vs. Frequency over Attenuation settings**

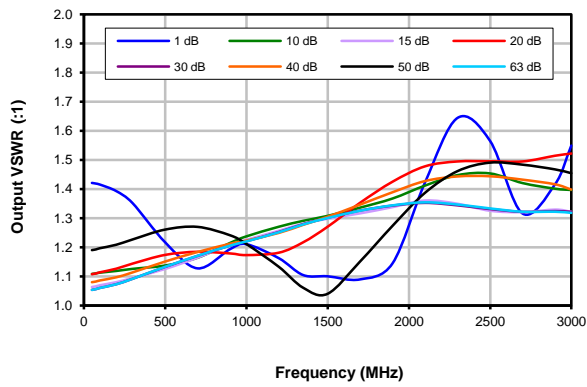

**IP3 @ 0dB Attenuation**

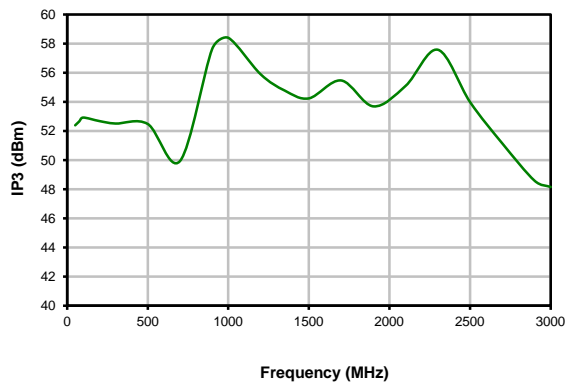

**Insertion Loss**

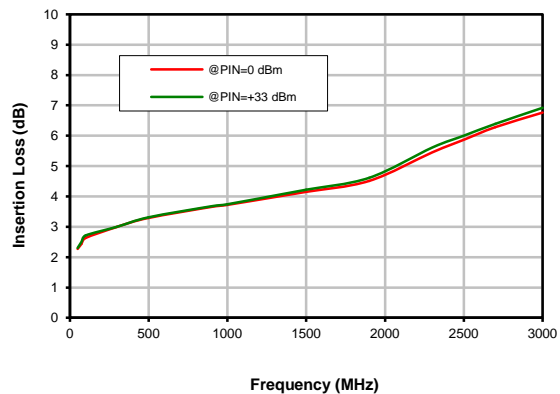

**Notes**

- A. Performance and quality attributes and conditions not expressly stated in this specification document are intended to be excluded and do not form a part of this specification document.
- B. Electrical specifications and performance data contained in this specification document are based on Mini-Circuit's applicable established test performance criteria and measurement instructions.
- C. The parts covered by this specification document are subject to Mini-Circuits standard limited warranty and terms and conditions (collectively, "Standard Terms"). Purchasers of this part are entitled to the rights and benefits contained therein. For a full statement of the Standard Terms and the exclusive rights and remedies thereunder, please visit Mini-Circuits' website at [www.minicircuits.com/MCLStore/terms.jsp](http://www.minicircuits.com/MCLStore/terms.jsp)



# Programmable Attenuator

# RCDAT-3000-63W2

## Typical Performance Curves @ 50°C

**Attenuation Accuracy vs. Frequency over Attenuation settings**

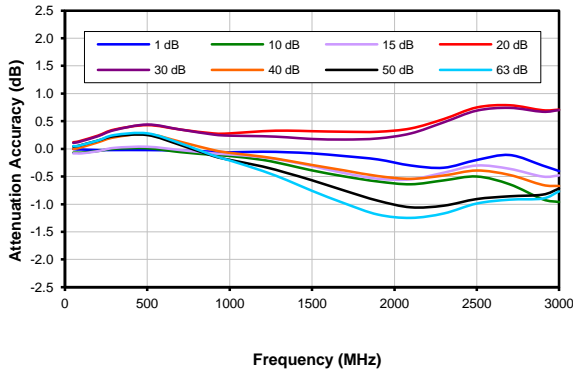

**Attenuation relative to I.L. vs. Frequency over Attenuation settings**

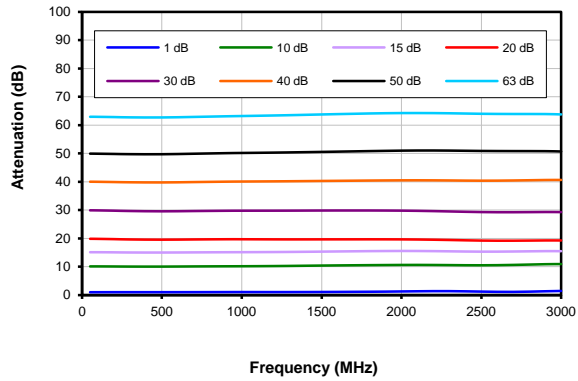

**IP3 @ 0dB Attenuation**

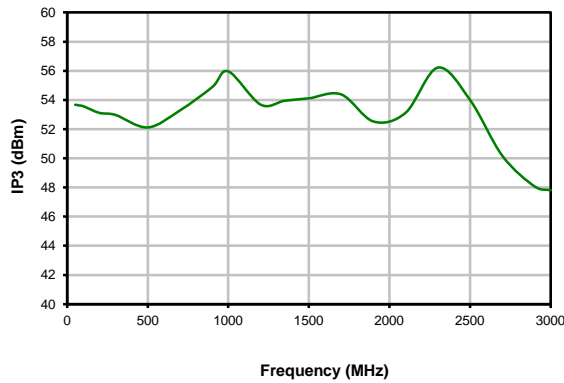

**Insertion Loss**

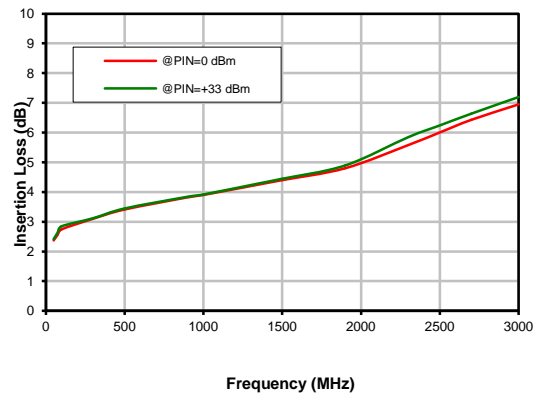

**Notes**

- A. Performance and quality attributes and conditions not expressly stated in this specification document are intended to be excluded and do not form a part of this specification document.
- B. Electrical specifications and performance data contained in this specification document are based on Mini-Circuit's applicable established test performance criteria and measurement instructions.
- C. The parts covered by this specification document are subject to Mini-Circuits standard limited warranty and terms and conditions (collectively, "Standard Terms"); Purchasers of this part are entitled to the rights and benefits contained therein. For a full statement of the Standard Terms and the exclusive rights and remedies thereunder, please visit Mini-Circuits' website at [www.minicircuits.com/MCLStore/terms.jsp](http://www.minicircuits.com/MCLStore/terms.jsp)



## Outline Dimensions

MS2065

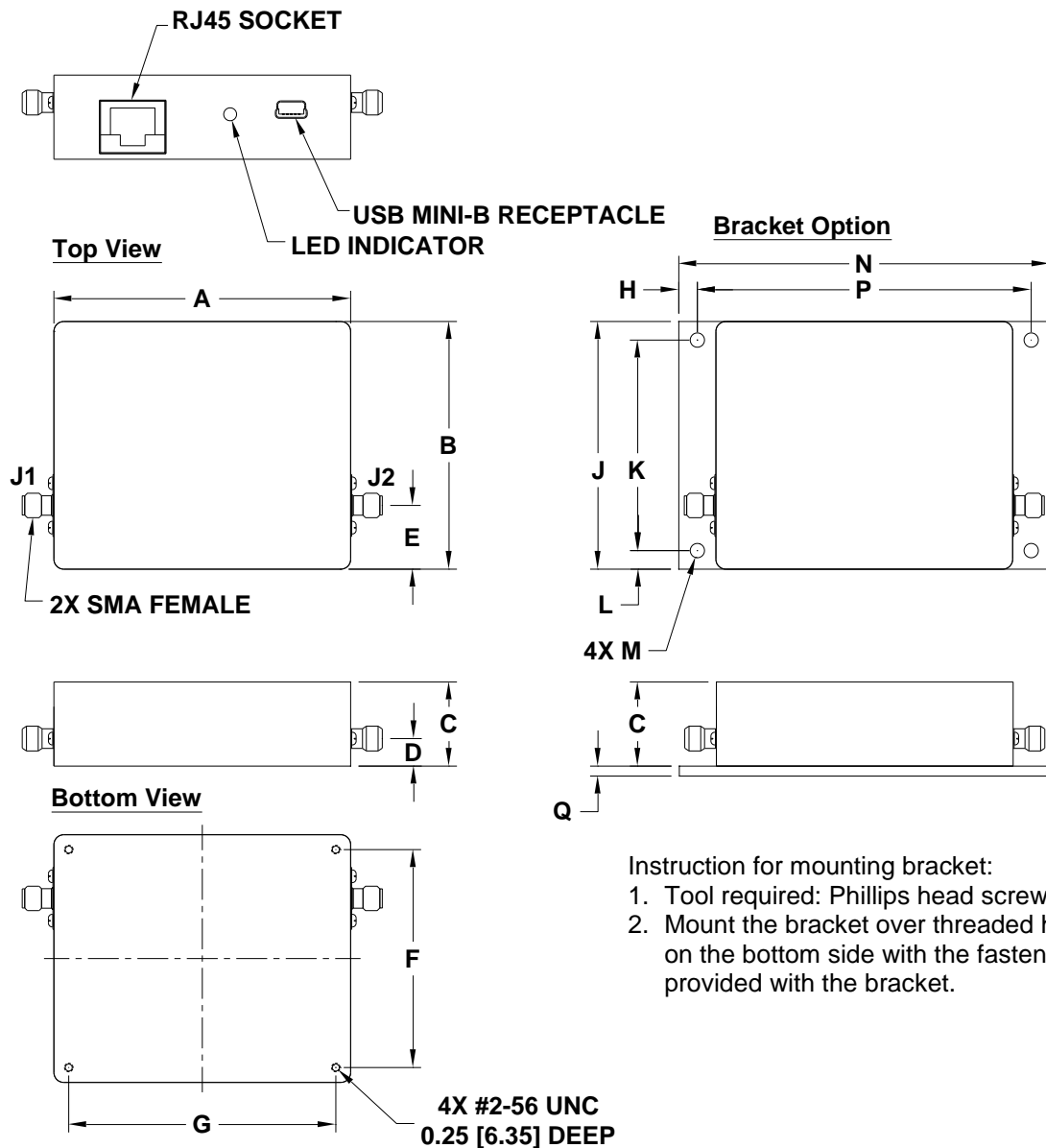

- Instruction for mounting bracket:
1. Tool required: Phillips head screwdriver
  2. Mount the bracket over threaded holes on the bottom side with the fasteners provided with the bracket.

CASE#	A	B	C	D	E	F	G	H	J	K	L	M	N	P	Q	WT. GRAMS
MS2065	3.00 (76.2)	2.50 (63.5)	.85 (21.6)	.28 (7.1)	.64 (16.3)	2.200 (55.88)	2.700 (68.58)	.188 (4.76)	2.50 (63.5)	2.125 (53.98)	.188 (4.76)	.144 (3.66)	3.75 (95.3)	3.375 (85.72)	.100 (2.54)	200

Dimensions are in inches (mm). Tolerances: 2PL. +/- .03; 3PL. +/- .015

### Notes:

1. Case material: Nickel Plated Aluminum.

**Mini-Circuits®**  
ISO 9001 ISO 14001 CERTIFIED

ALL NEW  
minicircuits.com

P.O. Box 350166, Brooklyn, New York 11235-0003 (718) 934-4500 Fax (718) 332-4661 For detailed performance specs & shopping online see Mini-Circuits web site



The Design Engineers Search Engine Provides ACTUAL Data Instantly From MINI-CIRCUITS At: [www.minicircuits.com](http://www.minicircuits.com)

RF/IF MICROWAVE COMPONENTS



Environmental Specifications **ENV55T1**

All Mini-Circuits products are manufactured under exacting quality assurance and control standards, and are capable of meeting published specifications after being subjected to any or all of the following physical and environmental test.

Specification	Test/Inspection Condition	Reference/Spec
Operating Temperature	-0° to 50° C Ambient Environment	Individual Model Data Sheet
Storage Temperature	-20° to 85° C Ambient Environment	Individual Model Data Sheet
Operating and Storage Humidity	5% to 85% RH (non-condensing)	Ambient
Bench Handling Test	Bench Top Tip 45° & Drop	MIL-PRF-28800F
Transit Drop Test	Free Fall Drop, 20 cm (7.9 inches)	MIL-PRF-28800F Class 3