

USB / ETHERNET / RS232 / TTL

Programmable Attenuator

RCDAT-18G-63

50Ω 0 – 63 dB, 0.25 dB step 100 to 18000 MHz

The Big Deal

- High Frequency, 18 GHz
- Fine attenuation resolution, 0.25 dB
- Fast switching speed
- **USB, Ethernet, RS232 and TTL control**



Software Package

Case Style: QF3189

Applications

- Automated Test Equipment (ATE)
- Transmission Loss / Fading Simulators
- Ku band satellite communications
- Receiver sensitivity testing (eg: GPS)
- Military radio, radar & electronic warfare

Product Overview

Mini-Circuits' RCDAT-18G-63 is a general purpose, single channel programmable attenuator suitable for a wide range of signal level control applications from 100 MHz to 18 GHz. The Attenuator provides 0 to 63 dB attenuation in 0.25 dB steps. Its unique design maintains linear attenuation change per dB, even at the highest attenuation settings.

The attenuator is housed in a compact and rugged package with 2.92 mm female RF connectors and USB type C, Ethernet (RJ45) and 15-pin D-sub control ports. The DC supply can be provided via the USB or D-sub ports.

The attenuator can be controlled via USB, Ethernet, RS232 or TTL (via D-Sub connector). Full software support is provided and can be downloaded from our website any time at <http://www.minicircuits.com/softwaredownload/patt.html>. The package includes our user-friendly GUI application for Windows® and a full API with programming instructions for Windows® and Linux® environments (both 32-bit and 64-bit systems).

Key Features

Feature	Advantages
USB & Ethernet control	USB HID and Ethernet (HTTP / Telnet / SSH) interfaces provide easy compatibility with a wide range of software setups and programming environments. The device draws all power requirements through the USB port.
RS232 and TTL control	The user may also control the RCDAT-18G-63 via RS232 or TTL connection, allowing also serial asynchronous or direct, high speed parallel control of the device.
Programmable attenuation sweep and Hop sequences	The RCDAT-18G-63 can be programmed with a timed sequence of attenuation settings, to run without any additional external control
63 dB attenuation range.	The RCDAT-18G-63 provides high-accuracy attenuation up to 63 dB in 0.25 dB steps, allowing the user precise level control over a broad attenuation range.

Trademarks: Windows is a registered trademark of Microsoft Corporation in the United States and other countries. Linux is a registered trademark of Linus Torvalds. Mac is a registered trademark of Apple Corporation. Pentium is a registered trademark of Intel Corporation. Neither Mini-Circuits nor the Mini-Circuits RCDAT-series attenuators are affiliated with or endorsed by the owners of the above referenced trademarks.

Mini-Circuits and the Mini-Circuits logo are registered trademarks of Scientific Components Corporation.

Connector	Model No.	Description	Qty.
2.92mm*	RCDAT-18G-63	Programmable Attenuator	1

* Compatible with SMA and 3.5mm (no adaptor needed)

Included Accessories

USB-CBL-AC-3+	3.3 ft USB cable	1
---------------	------------------	---

RoHS Compliant

See our web site for RoHS Compliance methodologies and qualifications



www.minicircuits.com P.O. Box 350166, Brooklyn, NY 11235-0003 (718) 934-4500 sales@minicircuits.com

Rev. A
ECO-009616
EDR-11845
RCDAT-18G-63
RAV
210909
Page 1 of 16

Electrical Specifications ¹ at 0°C to 50°C

Parameter	Frequency range	Conditions	Min.	Typ.	Max.	Units
Attenuation range	100 - 18000 MHz	0.25 dB step	0	-	63	dB
Attenuation accuracy ²	100 - 10000 MHz	@ 0.25-63 dB	-	0.6	±(0.35+2.5% of setting)	dB
	10000 - 18000 MHz		-	0.8	±(0.30+3.5% of setting)	
Insertion Loss	100 - 4000 MHz	@ 0 dB	-	4.0	5.5	dB
	4000 - 10000 MHz		-	5.3	7.0	
	10000 - 15000 MHz		-	6.5	8.5	
	15000 - 18000 MHz		-	7.5	10.0	
Input operating power ^{3,4}	(RF In port)	100 - 18000 MHz	@ 0 - 63 dB	-	+24	dBm
	(RF Out port)	100 - 18000 MHz	@ 0 - 63 dB	-	+15	dBm
Isolation In-Out	100 - 18000 MHz	Note 5	-	70	-	dB
IP3 Input ⁶	200 - 18000 MHz	@ 0 dB setting (P _{IN} =+5 dBm)	-	50	-	dBm
VSWR	100 - 18000 MHz	@ 0 - 63 dB	-	1.30	-	:1
Trigger response (USB, Ethernet or RS232)	100 - 18000 MHz	Note 7, 8	-	120	-	nsec
TTL control response	100 - 18000 MHz	Note 7, 8	-	120	-	nsec
Min Dwell Time ⁹	100 - 18000 MHz	High speed mode	-	600	-	µsec
Attenuation Transition Time ¹⁰	100 - 18000 MHz	-	-	80	-	nsec
Supply Voltage	-	-	4.75	5	5.25	V _{DC}
DC current draw	Ethernet	-	-	275	350	mA
	USB or RS232 (Ethernet disabled)	-	-	160	220	
	TTL	-	-	40	60	
Ethernet Communication	Protocol	TCP / IP, HTTP, Telnet, SSH, DHCP, UDP (limited)				
	Max Data Rate	100 Mbps (100 Base-T Full Duplex)				
USB Communication	Protocol	HID (Human Interface Device) - High Speed				
	Min Communication Time ¹¹	400 µs Typ (full transmit/receive cycle)				
TTL Communication	Protocol	Logic low=0.8V Max, Logic High=1.2V Min, 3.3V Max				
	Min Communication Time	120 ns Typ (after TTL control is enabled)				
RS232 Communication	Protocol	Meets RS232 standard at all voltages with RS232 communications set to 9600 bps; 8 bit word; no parity; stop bit = '1'.				

¹ Attenuator RF ports are interchangeable, and support simultaneous, bidirectional signal transmission, within the specified power limits. However the specifications are guaranteed for the RF in and RF out as noted on the label. There may be minor changes in performance when injecting signals to the RF Out port.

² Max accuracy defined as ±[absolute error+% of attenuation setting] for example when setting the attenuator to 50 dB attenuation the maximum error at 12000 MHz will be: ±(0.01x50+0.20)= ±(0.50+0.20)= ± 0.70 dB

³ Compression level not noted as it exceeds max safe operating power level.

⁴ With proper DC power connected. If DC power not connected (via either USB connector or D-Sub Pin#1), derate max power by 3dB.

⁵ Isolation is defined as max attenuation plus insertion loss; this is the path loss through the attenuator when initially powered up. After a brief delay (~0.5 sec typically) the attenuator will revert to a user defined "power-up" state (either max attenuation or a pre-set value).

⁶ Tested with 1 MHz span between signals. IP3 degrades below 200 MHz.

⁷ Trigger response measured from 50% of Trigger to signal within 10% of final value.

⁸ Pin#6 of the D-sub connector is used as LE in TTL control and Trigger in in USB and RS232 control

⁹ Minimum Dwell Time is the time the RCDAT will take to respond to a command to change attenuation states.

¹⁰ Attenuation Transition Time is specified as the time between starting to change the attenuation state and settling on the requested attenuation state.

¹¹ USB min communication time is based on the polling interval of the USB HID protocol (125 µs polling interval, 1024 bytes per packet), medium CPU load and no other high speed USB devices using the USB bus.

Absolute Maximum Ratings

Operating Temperature	0°C to 50°C	
Storage Temperature	-20°C to 85°C	
Voltage input at D-Sub Pin#5-14	-0.3V to +5.5V	
Voltage input at D-Sub Pin#3,4	-30V to +30V	
Voltage input at D-Sub Pin#2	+5.5V (GND to Vcc)	
Voltage input at D-Sub Pin#1	-1V to +6V	
V _{USB} Max.	6V	
DC voltage at RF port	16V	
Max RF power	@ RF In	+25 dBm
	@ RF Out	+16 dBm

Permanent damage may occur if any of these limits are exceeded. Operating in the range between operating power limits and absolute maximum ratings for extended periods of time may result in reduced life and reliability.

Connections

RF IN	(2.92 mm female)
RF OUT	(2.92 mm female)
USB	(USB type C female)
RS232 & TTL ¹²	(15 Pin D-Sub male)
Network (Ethernet/LAN)	(RJ45 socket)

¹² Refer to D-Sub pin connections table for details.

RCDAT response to communication interrupt

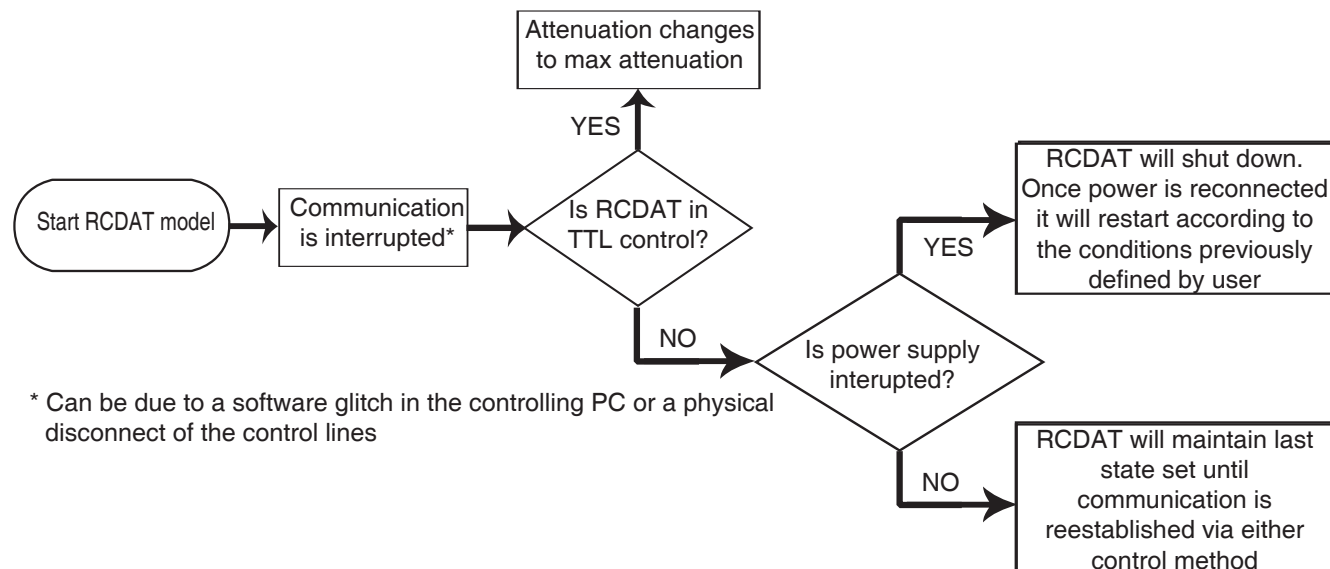

Trigger in

In USB, RS232 or Ethernet control the LE control bit can be used as trigger by holding it at logic low until you are ready to implement the command. As long as the LE is held at logic low the DSA state will remain unchanged regardless of commands sent. Once the trigger is set to logic high the latest attenuation command will be implemented. Lowering it again to logic low will keep the attenuation at that state until the next trigger is received.

This allows synchronizing the change of attenuation level with outside processes and eliminates the need to wait for communication delays caused by USB, Ethernet or RS232 communication speeds.

15 Pin D-Sub Pin Connections

PIN Number	RS232 Function	TTL Function	USB / Ethernet Function
1	Optional +5 V _{DC} ¹³	Optional +5 V _{DC} ¹³	Optional +5 V _{DC} ¹³
2	GND	GND	GND
3	RS232 Transmit	Do not connect	Do not connect
4	RS232 Receive	Do not connect	Do not connect
5	Do not connect	TTL Enable	Do not connect
6	Trigger In	LE	Trigger In
7	Do not connect	0.25 dB	Do not connect
8	Do not connect	0.5 dB	Do not connect
9	Do not connect	1 dB	Do not connect
10	Do not connect	2 dB	Do not connect
11	Do not connect	4 dB	Do not connect
12	Do not connect	8 dB	Do not connect
13	Do not connect	16 dB	Do not connect
14	Do not connect	31.5 dB	Do not connect
15	Do not connect	Do not connect	Do not connect

¹³ Pin#1 can be used as supply voltage (+) pin instead of USB connection. When USB power is connected, Pin#1 may be connected to GND or supply voltage (+) or remain disconnected.

Block Diagram

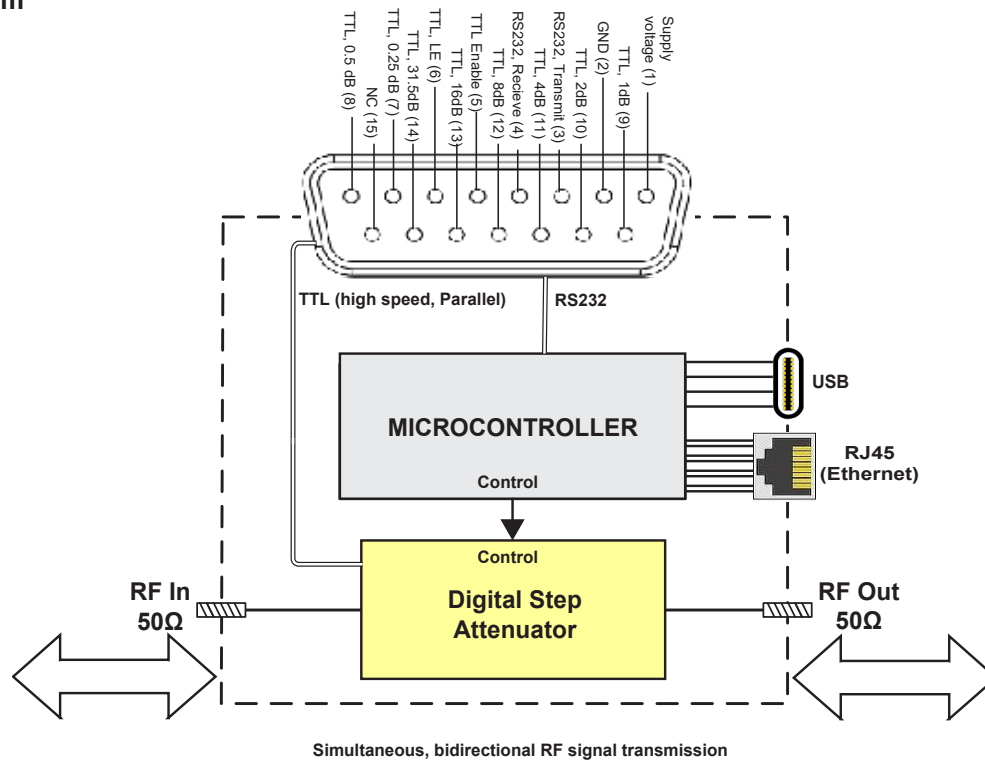

TTL communication parameters

Parameter		Conditions		Min.	Typ.	Max.	Units
Voltage levels		Logic High Voltage	Input	2.2	-	5	V
		Logic Low Voltage	Input	0	-	0.6	
Control Current	Vcntrl=0V	Per pin		-400	-	-	µA
	Vcntrl=3.3V			0	-	40	
	Vcntrl=5V			-	-	300	

TTL control allows direct parallel control of the RCDAT attenuation state, bypassing the micro controller for high speed response (120 nsec typical response). In order to start working with TTL, need to raise the TTL Enable momentarily to logic high, the internal micro-controller will go to sleep mode, disabling USB, Ethernet and RS232 control options and enabling the parallel TTL until power is cycled.

The TTL controls use 8 control bits buffered by a transparent latch to select the attenuation state. All TTL controls except the TTL Enable are connected through an internal 10 kΩ pull-up resistor to 3.3V, which sets the default state of the buffer to Max attenuation state (63.25 dB) with the latch set to 'transparent', allowing any signal on the attenuation control bits to translate immediately to a change in the attenuation state. When the LE is held at logic low the buffer is latched and the RCDAT will maintain the same attenuation state regardless of the input.

Table 1. Truth Table

Attenuation State	C31.5	C16	C8	C4	C2	C1	C0.5	C0.25
Reference	0	0	0	0	0	0	0	0
0.25 (dB)	0	0	0	0	0	0	0	1
0.5 (dB)	0	0	0	0	0	0	1	0
1 (dB)	0	0	0	0	0	1	0	0
2 (dB)	0	0	0	0	1	0	0	0
4 (dB)	0	0	0	1	0	0	0	0
8 (dB)	0	0	1	0	0	0	0	0
16 (dB)	0	1	0	0	0	0	0	0
31.5 (dB)	1	0	0	0	0	0	0	0
63 (dB)	1	1	1	1	1	1	1	0

Note: Not all 256 possible combinations of C0.25 - C31.5 are shown in table

The parallel interface timing requirements are defined by the Timing diagram and Parallel TTL AC interface on page 5.

For latched parallel programming the Latch Enable (LE) should be held LOW while changing attenuation state control values, then pulses HIGH to LOW (per Figure 1) to latch new attenuation state into device.

For direct parallel programming, the Latch Enable (LE) line should be pulled HIGH. Changing attenuation state control values will change device state to new attenuation. Direct mode is ideal for manual control of the device.

TTL timing diagram

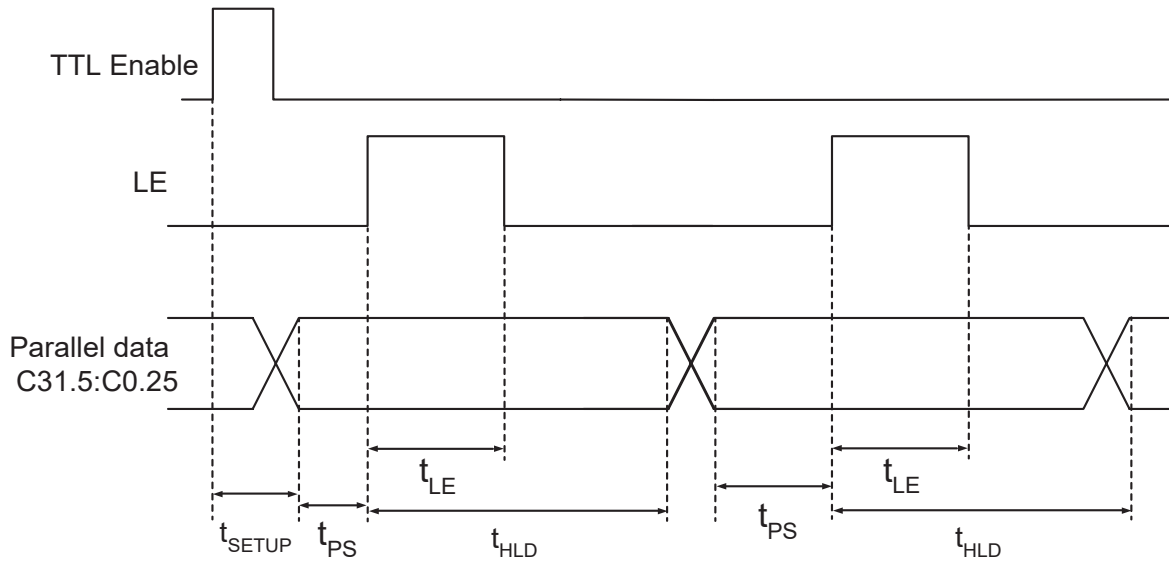

Parallel TTL Interface AC Characteristics				
Symbol	Parameter	Min.	Max.	Units
t_{SETUP}	TTL Enable setup time, used only to start the TTL control and afterwards not needed.	10	-	μs
t_{PS}	LE Setup time - time from when controls C0.25-C31.5 are set to LE rising edge.	2	-	ns
t_{LE}	LE pulse width	10	-	ns
t_{HLD}	Hold time the controls C0.25-C31.5 need to remain stable after the LE rising edge	10	-	ns

Outline Drawing (QF3189)

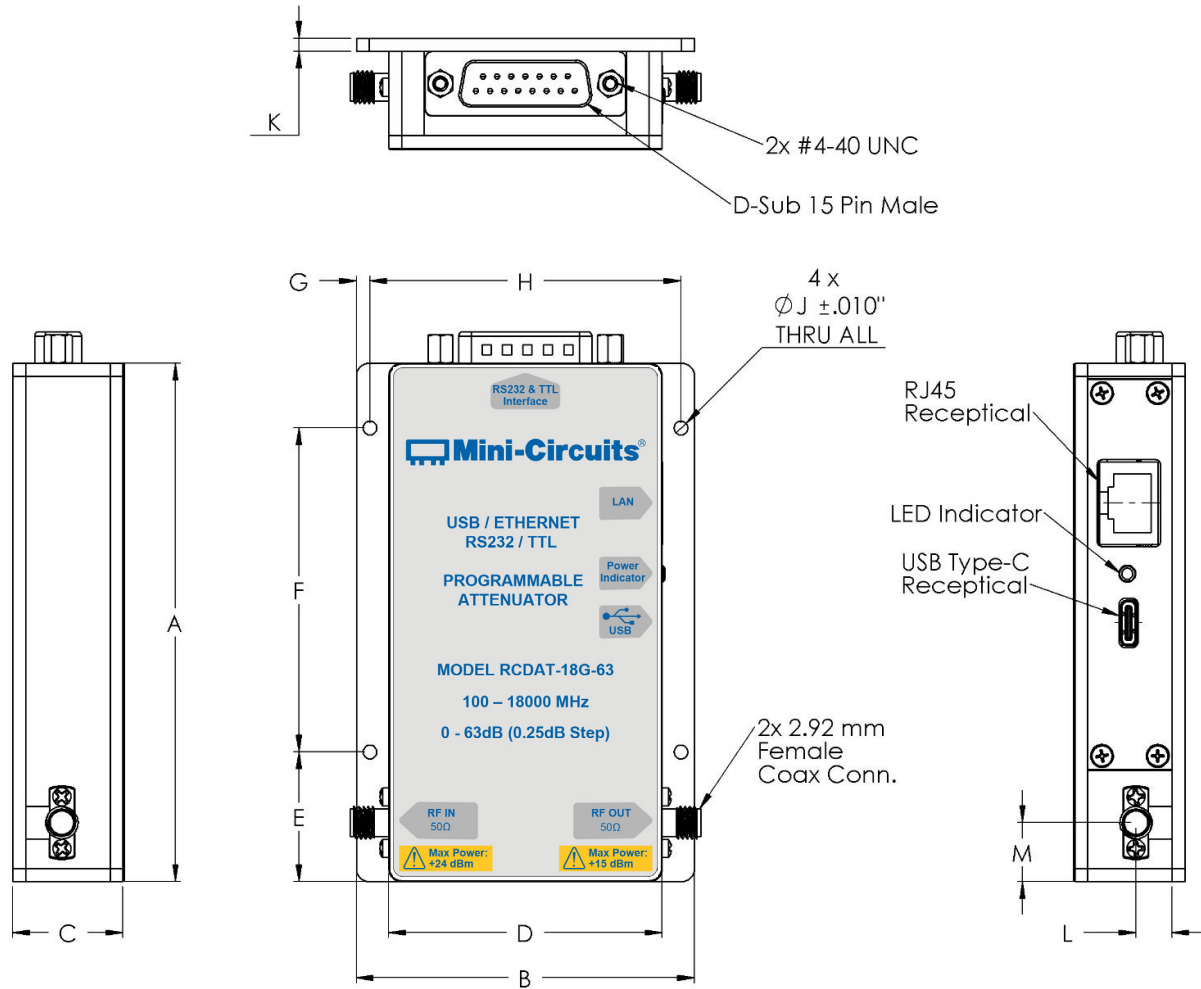

Outline Dimensions ($\frac{\text{inch}}{\text{mm}}$)

A	B	C	D	E	F	G	H	J	K	L	M	WT. GRAMS
4.00	2.61	0.85	2.11	1.00	2.50	0.105	2.40	0.106	0.10	0.278	0.455	250
101.6	66.29	21.59	53.59	25.40	63.50	2.67	60.96	2.69	2.54	7.06	11.56	

Typical Performance Data (Continued)

FREQ. (MHz)	I. Loss (dB)	Attenuation relative to I. Loss @0°C (dB)									
		@ Attenuation setting (dB)									
		0.25	1	5	10	20	30	40	50	60	63
100	3.01	0.28	1.00	5.06	10.08	20.12	30.11	40.22	50.25	60.21	63.02
500	3.28	0.27	1.00	5.04	10.08	20.10	30.09	40.21	50.22	60.19	63.20
1000	3.59	0.24	0.99	4.96	10.01	19.99	29.97	40.09	50.10	60.09	63.05
1500	3.73	0.20	0.99	4.96	10.02	20.00	29.98	40.08	50.09	60.09	63.08
2000	3.76	0.19	1.00	5.03	10.08	20.10	30.10	40.18	50.19	60.21	63.15
2500	3.87	0.18	1.00	5.04	10.08	20.12	30.14	40.21	50.22	60.24	63.20
3000	4.06	0.19	0.99	4.99	10.03	20.06	30.08	40.16	50.18	60.22	63.21
3500	4.23	0.20	0.98	4.95	10.01	20.01	30.04	40.12	50.14	60.15	63.14
4000	4.33	0.22	0.99	4.97	10.03	20.05	30.09	40.15	50.18	60.21	63.22
4500	4.41	0.23	0.99	5.00	10.06	20.10	30.16	40.20	50.23	60.29	63.28
5000	4.55	0.23	0.98	5.00	10.04	20.09	30.17	40.20	50.24	60.31	63.32
5500	4.69	0.22	0.97	4.99	10.01	20.07	30.17	40.20	50.24	60.33	63.35
6500	4.90	0.22	0.96	4.98	10.01	20.07	30.19	40.28	50.34	60.47	63.46
7500	4.97	0.19	0.97	5.05	10.08	20.19	30.35	40.50	50.58	60.73	63.75
8500	5.42	0.17	0.95	4.94	10.00	20.08	30.25	40.34	50.42	60.56	63.60
9500	5.48	0.25	0.99	5.03	10.15	20.25	30.43	40.50	50.61	60.77	63.81
10500	5.57	0.28	0.98	5.05	10.15	20.29	30.52	40.63	50.76	60.95	64.00
11500	5.89	0.25	0.98	5.01	10.13	20.26	30.50	40.58	50.72	60.94	63.99
12500	6.16	0.25	0.98	5.04	10.17	20.30	30.55	40.59	50.74	60.95	63.94
12750	6.22	0.25	0.97	5.03	10.15	20.29	30.55	40.58	50.73	60.95	63.98
13250	6.31	0.24	0.96	5.02	10.11	20.27	30.55	40.59	50.76	60.99	64.06
13500	6.35	0.24	0.95	5.02	10.10	20.26	30.54	40.61	50.78	61.01	64.07
14000	6.45	0.23	0.96	5.01	10.10	20.25	30.53	40.61	50.78	61.02	64.07
14250	6.53	0.23	0.96	5.00	10.10	20.24	30.52	40.60	50.76	61.03	64.08
14750	6.70	0.23	0.95	4.99	10.10	20.22	30.51	40.55	50.72	61.00	64.01
15000	6.78	0.23	0.94	4.98	10.09	20.22	30.50	40.53	50.72	60.95	63.97
15500	6.88	0.25	0.94	5.01	10.10	20.25	30.56	40.58	50.76	60.98	64.06
15750	6.89	0.25	0.93	5.03	10.11	20.27	30.59	40.64	50.82	61.01	64.06
16250	6.92	0.26	0.93	5.05	10.13	20.30	30.64	40.75	50.95	61.22	64.29
16500	6.95	0.26	0.93	5.05	10.13	20.31	30.65	40.78	50.99	61.26	64.33
17000	7.06	0.26	0.93	5.05	10.12	20.32	30.67	40.81	51.02	61.33	64.39
17250	7.13	0.25	0.93	5.05	10.11	20.32	30.67	40.81	51.02	61.35	64.41
17750	7.33	0.25	0.93	5.05	10.08	20.30	30.66	40.80	51.00	61.29	64.40
18000	7.47	0.24	0.93	5.04	10.07	20.28	30.64	40.77	50.97	61.25	64.36

FREQ. (MHz)	I. Loss (dB)	Attenuation relative to I. Loss @+50°C (dB)									
		@ Attenuation setting (dB)									
		0.25	1	5	10	20	30	40	50	60	63
100	3.33	0.29	0.99	5.04	9.97	19.90	29.75	39.73	49.59	59.25	62.65
500	3.63	0.27	0.99	5.01	9.96	19.87	29.72	39.71	49.58	59.43	62.36
1000	3.99	0.24	0.98	4.91	9.89	19.74	29.58	39.56	49.43	59.28	62.24
1500	4.16	0.20	0.97	4.91	9.90	19.75	29.59	39.54	49.41	59.26	62.21
2000	4.19	0.18	0.99	4.99	9.96	19.86	29.72	39.66	49.52	59.36	62.33
2500	4.31	0.18	0.99	5.00	9.97	19.88	29.76	39.69	49.55	59.43	62.39
3000	4.53	0.18	0.97	4.94	9.91	19.81	29.69	39.63	49.50	59.40	62.35
3500	4.72	0.20	0.96	4.90	9.89	19.75	29.64	39.57	49.45	59.36	62.32
4000	4.82	0.22	0.97	4.93	9.92	19.80	29.70	39.61	49.49	59.40	62.34
4500	4.92	0.23	0.97	4.96	9.94	19.85	29.77	39.66	49.54	59.46	62.41
5000	5.07	0.23	0.96	4.96	9.92	19.84	29.77	39.66	49.56	59.49	62.43
5500	5.21	0.22	0.95	4.94	9.89	19.83	29.77	39.66	49.56	59.51	62.46
6500	5.43	0.21	0.94	4.94	9.89	19.83	29.81	39.74	49.67	59.65	62.65
7500	5.52	0.18	0.96	5.01	9.97	19.96	29.97	39.99	49.93	59.95	62.88
8500	6.03	0.17	0.94	4.90	9.89	19.83	29.85	39.79	49.73	59.75	62.73
9500	6.04	0.25	0.98	5.00	10.03	20.01	30.06	39.98	49.96	60.01	63.00
10500	6.19	0.28	0.96	4.99	10.01	20.02	30.10	40.06	50.03	60.09	63.12
11500	6.57	0.26	0.97	4.97	10.02	20.01	30.08	40.01	50.00	60.05	63.08
12500	6.85	0.25	0.97	5.00	10.04	20.05	30.14	40.01	50.01	60.07	63.09
12750	6.92	0.25	0.96	4.99	10.02	20.03	30.14	40.00	50.01	60.07	63.02
13250	7.03	0.24	0.94	4.98	9.98	20.01	30.13	40.01	50.01	60.12	63.14
13500	7.07	0.24	0.94	4.97	9.97	20.00	30.12	40.02	50.03	60.13	63.15
14000	7.18	0.23	0.94	4.97	9.97	19.99	30.11	40.03	50.04	60.15	63.16
14250	7.26	0.23	0.94	4.96	9.97	19.98	30.10	40.01	50.03	60.15	63.17
14750	7.43	0.23	0.93	4.94	9.96	19.96	30.08	39.97	49.98	60.08	63.08
15000	7.51	0.24	0.93	4.95	9.96	19.96	30.09	39.97	49.97	60.04	63.10
15500	7.58	0.25	0.92	4.97	9.98	19.99	30.14	40.03	50.05	60.11	63.13
15750	7.60	0.25	0.92	4.99	9.99	20.02	30.17	40.08	50.12	60.24	63.18
16250	7.64	0.26	0.92	5.01	10.01	20.05	30.21	40.17	50.22	60.33	63.32
16500	7.68	0.26	0.92	5.01	10.01	20.05	30.23	40.21	50.26	60.40	63.39
17000	7.79	0.25	0.92	5.01	10.01	20.07	30.25	40.26	50.32	60.47	63.49
17250	7.88	0.25	0.92	5.01	10.00	20.06	30.25	40.26	50.32	60.46	63.47
17750	8.11	0.24	0.92	5.00	9.96	20.04	30.24	40.23	50.29	60.44	63.43
18000	8.28	0.23	0.92	4.99	9.95	20.02	30.22	40.19	50.26	60.38	63.42

Typical Performance Curves

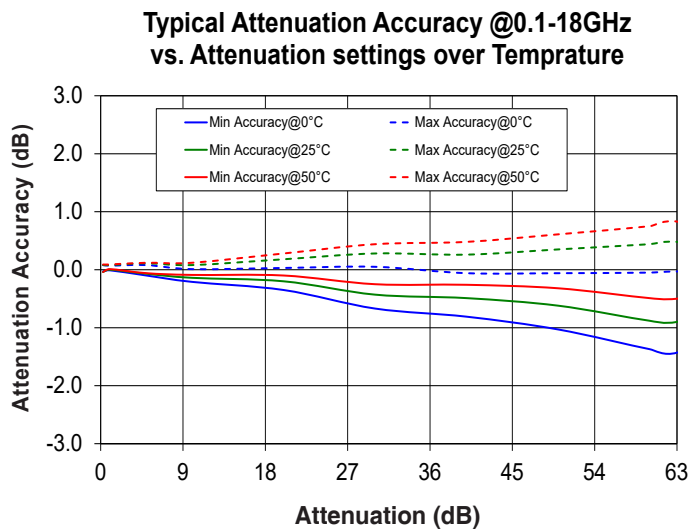
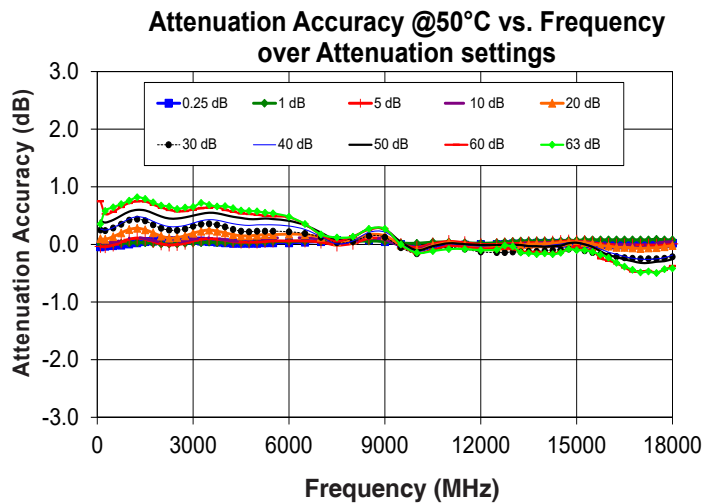
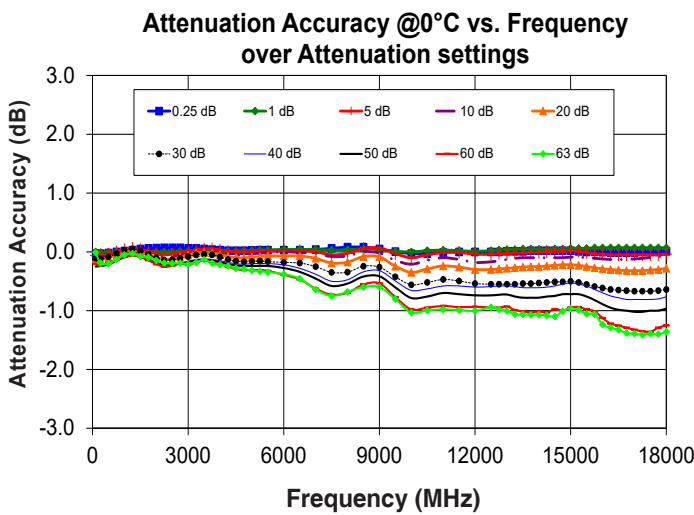
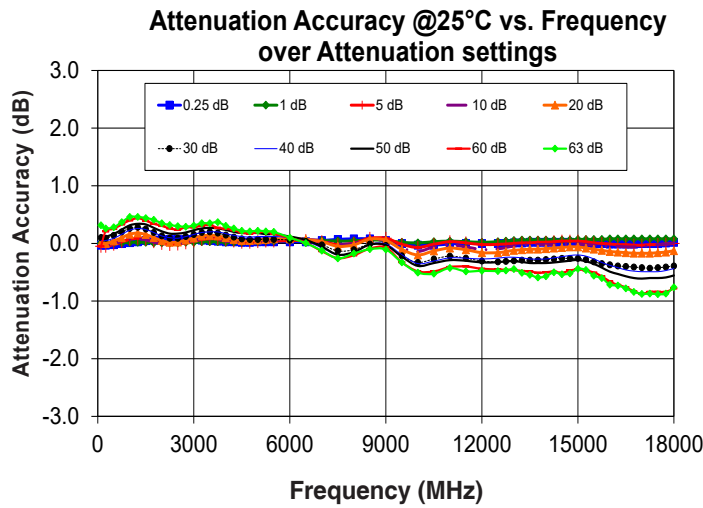

Typical Performance Curves (Continued) *

*at +25°C unless noted otherwise

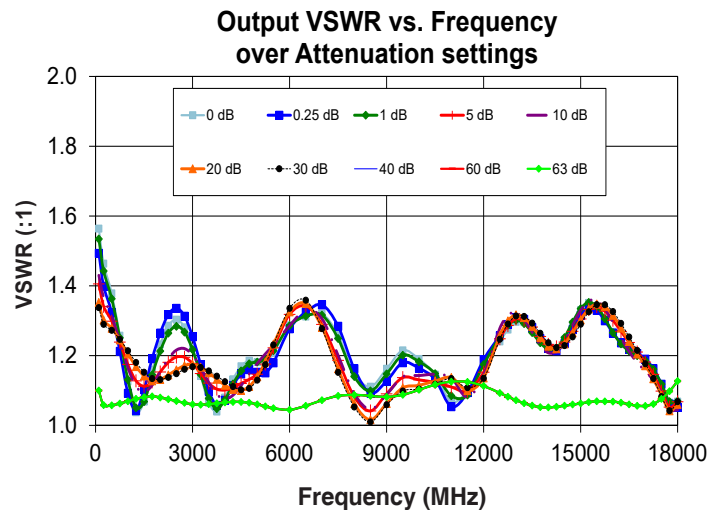
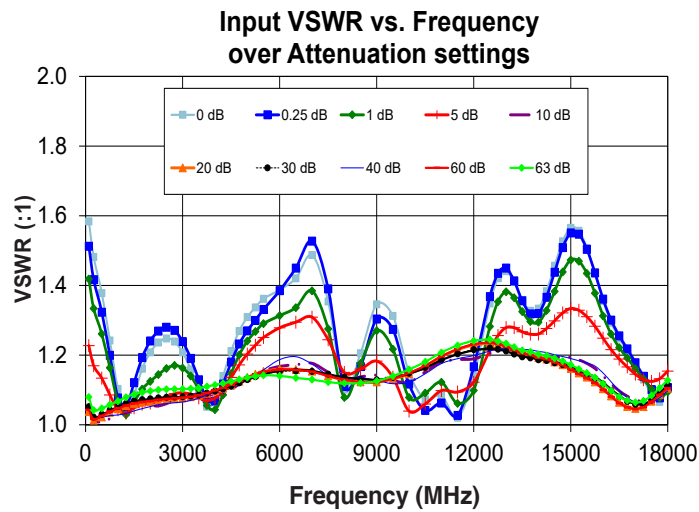
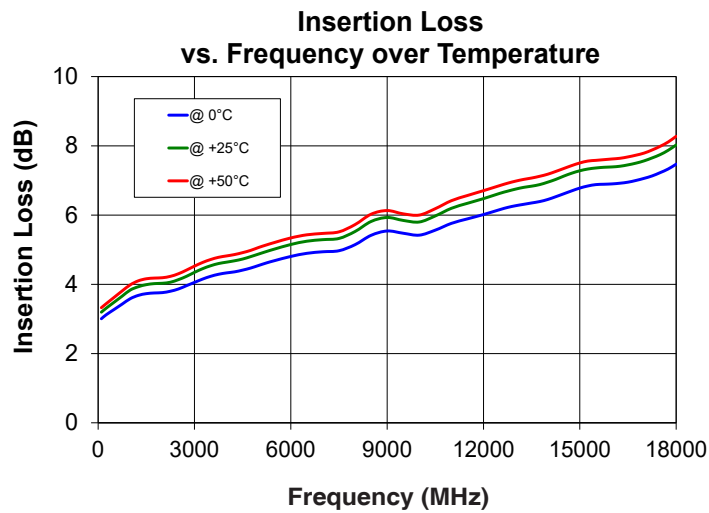

Typical Transition times @ +25°C

Note: All transition time tests performed with input signal of 501 MHz, 0 dBm.

Transition (without Trigger) 5 dB to 15.75 dB,
tested using Oscilloscope

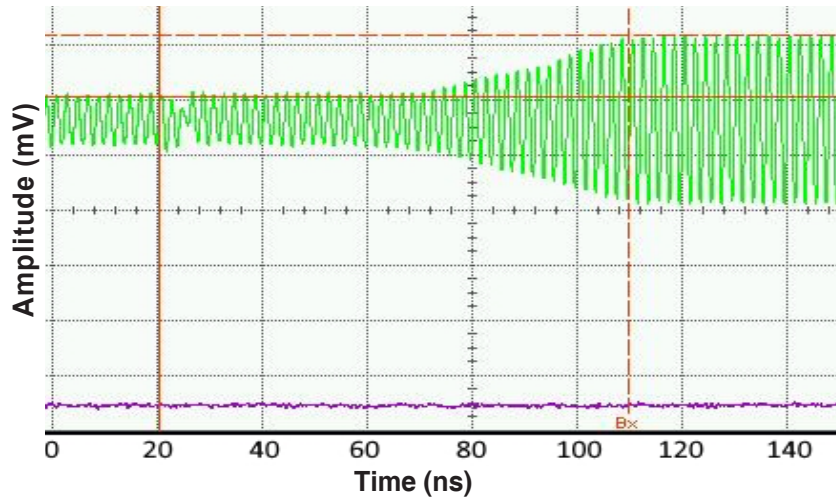

Rise time at transition 5 to 15.75 dB:
 Δt : 89.5 ns ; ΔV : 110.3 mV
 Scale 20 ns/dev ; 100 mV/dev

Trigger delay 5 dB to 15.75 dB,
tested using Oscilloscope

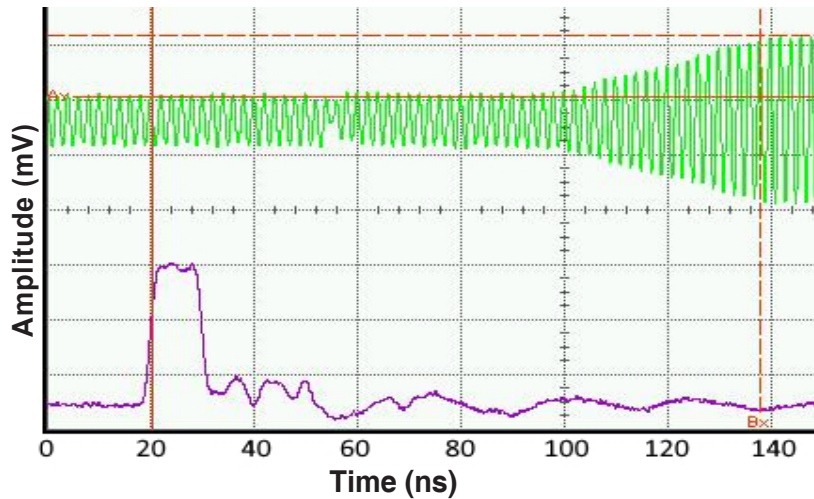

Rise time at transition 5 to 15.75 dB:
 Δt : 117.4 ns ; ΔV : 110.3 mV
 Scale 20 ns/dev ; 100 mV/dev

Typical Transition times @ +25°C (Continued)

Note: All transition time tests performed with input signal of 501 MHz, 0 dBm.

Transition (without Trigger) 15.75 dB to 5 dB,
tested using Oscilloscope

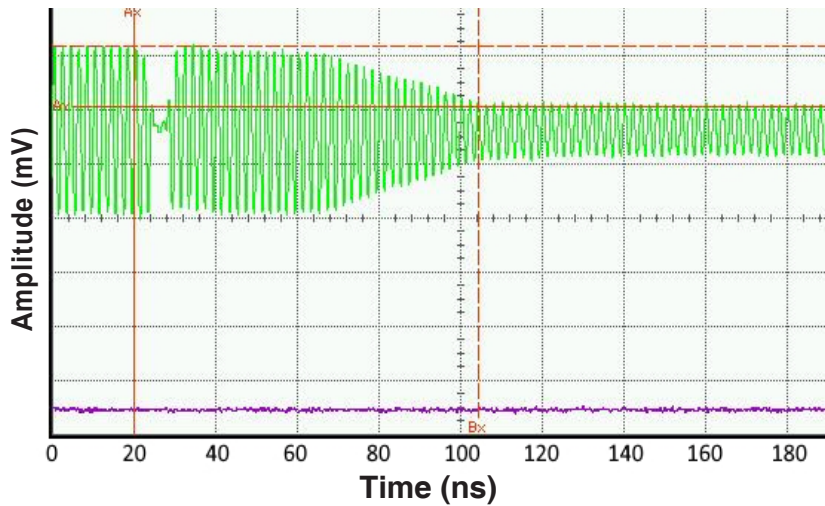

Fall time at transition 15.75 to 5 dB:
 Δt : 84.4 ns ; ΔV : 110.3 mV
 Scale 20 ns/dev ; 100 mV/dev

Trigger delay 15.75 dB to 5 dB,
tested using Oscilloscope

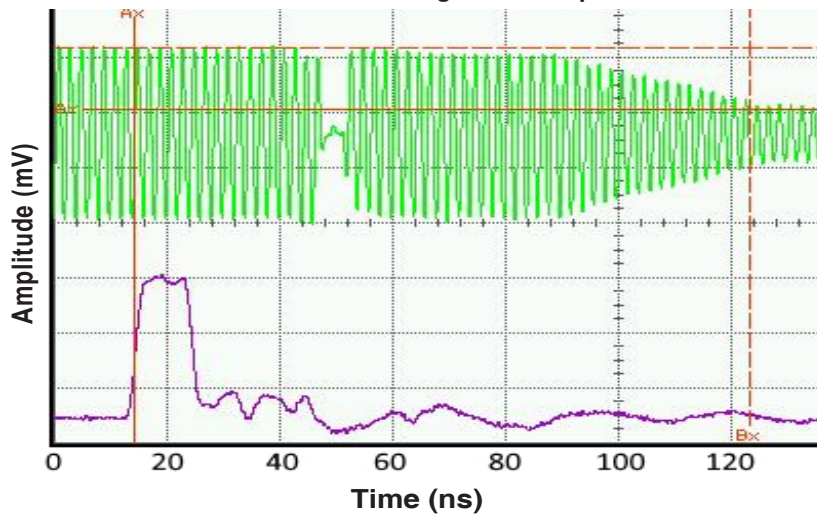

Fall time at transition 15.75 to 5 dB:
 Δt : 109.1 ns ; ΔV : 110.3 mV
 Scale 20 ns/dev ; 100 mV/dev

Software & Documentation Download:

- Mini-Circuits' full software and support package including user guide, Windows GUI, DLL files, programming manual and examples can be downloaded free of charge from <http://www.minicircuits.com/softwaredownload/patt.html>
- Please contact testsolutions@minicircuits.com for support

Minimum System Requirements

Parameter	Requirements	
Interface	USB HID or RS232 or TTL protocols	
System requirements	GUI:	Windows 32 & 64 bit systems from Windows 98 up to Windows 10
	USB API (ActiveX & .Net)	Windows 32 & 64 bit systems with ActiveX or .Net support from Windows 98 up to Windows 10
	USB direct programming support	Linux, Windows systems from Windows 98 up to Windows 10
	TTL	Any computer with a suitable I/O port
	RS232	Any computer with a serial port and Russ support
Hardware	Pentium® II or higher, RAM 256 MB	

Graphical User Interface (GUI) for Windows

Key Features:

- Manual attenuation setting
- Sweep and Hop attenuation sequences directed from the PC, or entire sequence loaded into RCDAT.
- Attenuator address configuration and Firmware upgrade
- Attenuation at power up may be set to selected attenuation level or last attenuation state recorded.
- USB, Ethernet or RS232 control of RCDAT

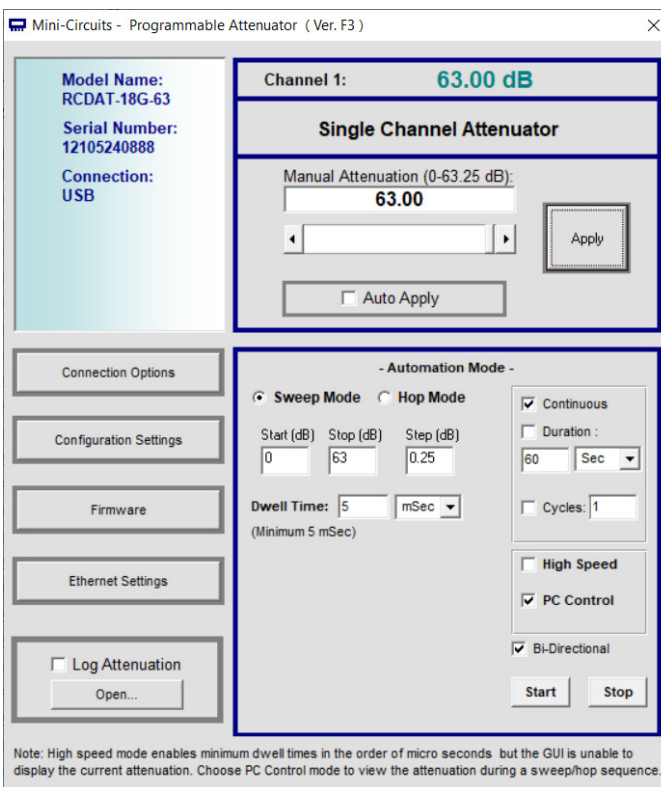

Application Programming Interface (API)

Programming manual: https://www.minicircuits.com/softwaredownload/Prog_Manual-6-Programmable_Attenuator.pdf

Windows Support:

- API DLL files exposing the full switch functionality
 - ActiveX COM DLL file for creation of 32-bit programs
 - .Net library DLL file for creation of 32 / 64-bit programs
- Supported by most common programming environments (refer to application note [AN-49-001](#) for summary of tested environments)

Linux Support:

- Full attenuator control in a Linux environment is achieved by way of USB interrupt commands.

Recommended Accessories

An optional cable accessory for RS232 and TTL control which is available with RCDAT-18G-63, the DSUB15-FPT-1.5+ 'pig tail' cable. DSUB15-FPT-1.5+ is a shielded cable with a 'pig tail' (bare wires) end allowing customer to assemble their own cable with any connector they need. Cable length is 1.5 feet / 0.46 meters using 28 AWG wires.

Control Cable DSUB15-FPT-1.5+

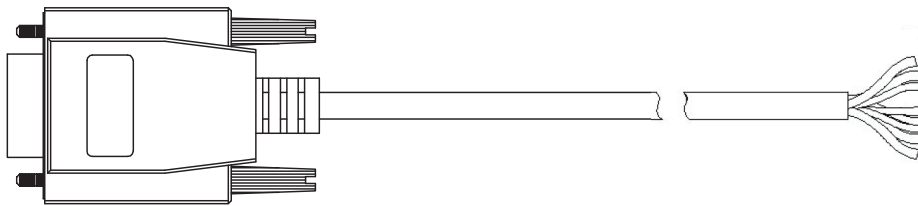

Pin Number	when used for RS232 control		when used for TTL control		Pigtail Wire Color
	Function	Description	Function	Description	
1	Vcc	Supply Voltage	Vcc	Supply Voltage	Red
2	GND	Ground connection	GND	Ground connection	Black
3	Tx	RS232 Transmit	N/A	Do not connect	White
4	Rx	RS232 Receive	N/A	Do not connect	Green
5	N/A	Do not connect	TE	TTL Enable	Orange
6	Trig	Trigger In	LE	Latch Enable	Blue
7	N/A	Do not connect	C0.25	0.25 dB	White/Black
8	N/A	Do not connect	C0.5	0.5 dB	Red/Black
9	N/A	Do not connect	C1	1 dB	Green/Black
10	N/A	Do not connect	C2	2 dB	Orange/Black
11	N/A	Do not connect	C4	4 dB	Blue/Black
12	N/A	Do not connect	C8	8 dB	Black/White
13	N/A	Do not connect	C16	16 dB	Red/White
14	N/A	Do not connect	C31.5	31.5 dB	Green/White
15	N/A	Do not connect	N/A	Do not connect	Blue/White

Ordering Information

Model	Description
RCDAT-18G-63	USB/Ethernet/RS232/TTL Programmable Attenuator

Included Accessories	Part No.	Description
	USB-CBL-AC-3+	3.3 ft (1.0 m) USB Cable: USB type A(Male) to USB type C(Male)

Optional Accessories	Description
USB-AC/DC-5 ^{14,15}	AC/DC 5V _{DC} Power Adapter with US, EU, IL, UK, AUS, and China power plugs
USB-CBL-AC-3+ (spare)	3.3 ft (1.0 m) USB Cable: USB type A(Male) to USB type C(Male)
CBL-RJ45-MM-5+	5 ft (1.5 m) Ethernet cable: RJ45(Male) to RJ45(Male) Cat 5E cable
DSUB15-FPT-1.5+	1.5 ft (0.46 m) RS232 & TTL Cable: 15 pin D-sub(Female) to Pig-Tail (Bare wires)

¹⁴ Not used in USB control. USB-AC/DC-5 can be used to provide the 5V_{DC} power when control is via RS232 or TTL; units can also accept DC supply voltage at Pin#1 of the D-sub connector.

¹⁵ Power plugs for other countries are also available, if you need a power plug for a country not listed please contact testsolutions@minicircuits.com

Additional Notes

- A. Performance and quality attributes and conditions not expressly stated in this specification document are intended to be excluded and do not form a part of this specification document.
- B. Electrical specifications and performance data contained in this specification document are based on Mini-Circuit's applicable established test performance criteria and measurement instructions.
- C. The parts covered by this specification document are subject to Mini-Circuits standard limited warranty and terms and conditions (collectively, "Standard Terms"); Purchasers of this part are entitled to the rights and benefits contained therein. For a full statement of the Standard Terms and the exclusive rights and remedies thereunder, please visit Mini-Circuits' website at www.minicircuits.com/MCLStore/terms.jsp

Programmable Attenuator

RCDAT-18G-63

Typical Performance Data @ 0°C

FREQUENCY (MHz)	Attenuation relative to Insertion Loss (dB)									
	0.25 dB	1 dB	5 dB	10 dB	20 dB	30 dB	40 dB	50 dB	60 dB	63 dB
100	0.28	1.00	5.06	10.08	20.12	30.11	40.22	50.25	60.21	63.02
250	0.28	1.01	5.07	10.09	20.13	30.12	40.24	50.24	60.23	63.19
500	0.27	1.00	5.04	10.08	20.10	30.09	40.21	50.22	60.19	63.20
750	0.25	1.00	5.00	10.04	20.04	30.03	40.15	50.15	60.13	63.13
1000	0.24	0.99	4.96	10.01	19.99	29.97	40.09	50.10	60.09	63.05
1250	0.22	0.99	4.94	10.00	19.97	29.95	40.06	50.06	60.06	63.03
1500	0.20	0.99	4.96	10.02	20.00	29.98	40.08	50.09	60.09	63.08
1750	0.19	1.00	4.99	10.05	20.05	30.04	40.13	50.14	60.14	63.09
2000	0.19	1.00	5.03	10.08	20.10	30.10	40.18	50.19	60.21	63.15
2250	0.18	1.00	5.05	10.09	20.13	30.14	40.21	50.22	60.25	63.19
2500	0.18	1.00	5.04	10.08	20.12	30.14	40.21	50.22	60.24	63.20
2750	0.18	0.99	5.02	10.06	20.09	30.11	40.19	50.20	60.20	63.19
3000	0.19	0.99	4.99	10.03	20.06	30.08	40.16	50.18	60.22	63.21
3250	0.19	0.98	4.97	10.01	20.02	30.05	40.13	50.15	60.18	63.18
3500	0.20	0.98	4.95	10.01	20.01	30.04	40.12	50.14	60.15	63.14
3750	0.21	0.98	4.95	10.01	20.02	30.05	40.13	50.15	60.18	63.19
4000	0.22	0.99	4.97	10.03	20.05	30.09	40.15	50.18	60.21	63.22
4250	0.23	0.99	4.99	10.05	20.08	30.13	40.18	50.21	60.25	63.24
4500	0.23	0.99	5.00	10.06	20.10	30.16	40.20	50.23	60.29	63.28
4750	0.23	0.98	5.00	10.05	20.10	30.17	40.21	50.24	60.31	63.29
5000	0.23	0.98	5.00	10.04	20.09	30.17	40.20	50.24	60.31	63.32
5250	0.22	0.97	4.99	10.02	20.08	30.16	40.20	50.24	60.31	63.33
5500	0.22	0.97	4.99	10.01	20.07	30.17	40.20	50.24	60.33	63.35
6000	0.22	0.96	4.98	10.00	20.07	30.18	40.22	50.28	60.39	63.38
6500	0.22	0.96	4.98	10.01	20.07	30.19	40.28	50.34	60.47	63.46
7000	0.21	0.96	5.00	10.03	20.11	30.25	40.38	50.46	60.63	63.64
7500	0.19	0.97	5.05	10.08	20.19	30.35	40.50	50.58	60.73	63.75
8000	0.17	0.97	5.03	10.07	20.18	30.35	40.48	50.54	60.70	63.68
8500	0.17	0.95	4.94	10.00	20.08	30.25	40.34	50.42	60.56	63.60
9000	0.20	0.96	4.94	10.02	20.09	30.26	40.32	50.42	60.54	63.60
9500	0.25	0.99	5.03	10.15	20.25	30.43	40.50	50.61	60.77	63.81
10000	0.28	1.00	5.10	10.21	20.35	30.56	40.66	50.79	60.98	64.04
10500	0.28	0.98	5.05	10.15	20.29	30.52	40.63	50.76	60.95	64.00
11000	0.26	0.97	5.01	10.10	20.24	30.47	40.58	50.70	60.92	63.98
11500	0.25	0.98	5.01	10.13	20.26	30.50	40.58	50.72	60.94	63.99
12000	0.25	0.99	5.04	10.18	20.30	30.54	40.60	50.74	60.94	64.01
12500	0.25	0.98	5.04	10.17	20.30	30.55	40.59	50.74	60.95	63.94
12750	0.25	0.97	5.03	10.15	20.29	30.55	40.58	50.73	60.95	63.98
13000	0.24	0.96	5.03	10.13	20.28	30.55	40.58	50.73	60.93	64.01
13250	0.24	0.96	5.02	10.11	20.27	30.55	40.59	50.76	60.99	64.06
13500	0.24	0.95	5.02	10.10	20.26	30.54	40.61	50.78	61.01	64.07
13750	0.23	0.95	5.01	10.10	20.25	30.54	40.61	50.78	61.03	64.07
14000	0.23	0.96	5.01	10.10	20.25	30.53	40.61	50.78	61.02	64.07
14250	0.23	0.96	5.00	10.10	20.24	30.52	40.60	50.76	61.03	64.08
14500	0.23	0.95	4.99	10.10	20.23	30.51	40.58	50.75	60.98	64.10
14750	0.23	0.95	4.99	10.10	20.22	30.51	40.55	50.72	61.00	64.01
15000	0.23	0.94	4.98	10.09	20.22	30.50	40.53	50.72	60.95	63.97
15250	0.24	0.94	4.99	10.09	20.23	30.52	40.55	50.72	60.94	63.99
15500	0.25	0.94	5.01	10.10	20.25	30.56	40.58	50.76	60.98	64.06
15750	0.25	0.93	5.03	10.11	20.27	30.59	40.64	50.82	61.01	64.06
16000	0.26	0.93	5.04	10.12	20.29	30.62	40.70	50.89	61.13	64.24
16250	0.26	0.93	5.05	10.13	20.30	30.64	40.75	50.95	61.22	64.29
16500	0.26	0.93	5.05	10.13	20.31	30.65	40.78	50.99	61.26	64.33
16750	0.26	0.93	5.05	10.13	20.32	30.66	40.81	51.00	61.29	64.38
17000	0.26	0.93	5.05	10.12	20.32	30.67	40.81	51.02	61.33	64.39
17250	0.25	0.93	5.05	10.11	20.32	30.67	40.81	51.02	61.35	64.41
17500	0.25	0.93	5.05	10.10	20.31	30.67	40.81	51.00	61.36	64.39
17750	0.25	0.93	5.05	10.08	20.30	30.66	40.80	51.00	61.29	64.40
18000	0.24	0.93	5.04	10.07	20.28	30.64	40.77	50.97	61.25	64.36

Notes

- A. Performance and quality attributes and conditions not expressly stated in this specification document are intended to be excluded and do not form a part of this specification document.
- B. Electrical specifications and performance data contained in this specification document are based on Mini-Circuits' applicable established test performance criteria and measurement instructions.
- C. The parts covered by this specification document are subject to Mini-Circuits' standard limited warranty and terms and conditions (collectively, "Standard Terms"); Purchasers of this part are entitled to the rights and benefits contained therein. For a full statement of the Standard Terms and the exclusive rights and remedies thereunder, please visit Mini-Circuits' website at www.minicircuits.com/ACL/Store/terms.jsp



Programmable Attenuator

RCDAT-18G-63

Typical Performance Data @ 0°C

FREQUENCY (MHz)	Attenuation accuracy relative to nominal attenuation setting (dB)									
	0.25 dB	1 dB	5 dB	10 dB	20 dB	30 dB	40 dB	50 dB	60 dB	63 dB
100	-0.03	0.00	-0.06	-0.08	-0.12	-0.11	-0.22	-0.25	-0.21	-0.02
250	-0.03	-0.01	-0.07	-0.09	-0.13	-0.12	-0.24	-0.24	-0.23	-0.19
500	-0.02	0.00	-0.04	-0.08	-0.10	-0.09	-0.21	-0.22	-0.19	-0.20
750	0.00	0.00	0.00	-0.04	-0.04	-0.03	-0.15	-0.15	-0.13	-0.13
1000	0.02	0.01	0.04	-0.01	0.01	0.03	-0.09	-0.10	-0.09	-0.05
1250	0.03	0.01	0.06	0.00	0.03	0.05	-0.06	-0.06	-0.06	-0.03
1500	0.05	0.01	0.04	-0.02	0.01	0.02	-0.08	-0.09	-0.09	-0.08
1750	0.06	0.00	0.01	-0.05	-0.05	-0.04	-0.13	-0.14	-0.14	-0.09
2000	0.07	0.00	-0.03	-0.08	-0.10	-0.10	-0.18	-0.19	-0.21	-0.15
2250	0.07	0.00	-0.05	-0.09	-0.13	-0.14	-0.21	-0.22	-0.25	-0.19
2500	0.07	0.00	-0.04	-0.08	-0.12	-0.14	-0.21	-0.22	-0.24	-0.20
2750	0.07	0.01	-0.02	-0.06	-0.09	-0.11	-0.19	-0.20	-0.20	-0.19
3000	0.06	0.01	0.01	-0.03	-0.06	-0.08	-0.16	-0.18	-0.22	-0.21
3250	0.06	0.02	0.03	-0.01	-0.02	-0.05	-0.13	-0.15	-0.18	-0.18
3500	0.05	0.02	0.05	-0.01	-0.01	-0.04	-0.12	-0.14	-0.15	-0.14
3750	0.04	0.02	0.05	-0.01	-0.02	-0.05	-0.13	-0.15	-0.18	-0.19
4000	0.03	0.01	0.03	-0.03	-0.05	-0.09	-0.15	-0.18	-0.21	-0.22
4250	0.02	0.01	0.01	-0.05	-0.08	-0.13	-0.18	-0.21	-0.25	-0.24
4500	0.02	0.01	0.00	-0.06	-0.10	-0.16	-0.20	-0.23	-0.29	-0.28
4750	0.02	0.02	0.00	-0.05	-0.10	-0.17	-0.21	-0.24	-0.31	-0.29
5000	0.03	0.02	0.00	-0.04	-0.09	-0.17	-0.20	-0.24	-0.31	-0.32
5250	0.03	0.03	0.01	-0.02	-0.08	-0.16	-0.20	-0.24	-0.31	-0.33
5500	0.03	0.03	0.01	-0.01	-0.07	-0.17	-0.20	-0.24	-0.33	-0.35
6000	0.03	0.04	0.02	0.00	-0.07	-0.18	-0.22	-0.28	-0.39	-0.38
6500	0.03	0.04	0.02	-0.01	-0.07	-0.19	-0.28	-0.34	-0.47	-0.46
7000	0.04	0.04	0.00	-0.03	-0.11	-0.25	-0.38	-0.46	-0.63	-0.64
7500	0.06	0.03	-0.05	-0.08	-0.19	-0.35	-0.50	-0.58	-0.73	-0.75
8000	0.08	0.04	-0.03	-0.07	-0.18	-0.35	-0.48	-0.54	-0.70	-0.68
8500	0.08	0.05	0.06	0.00	-0.08	-0.25	-0.34	-0.42	-0.56	-0.60
9000	0.05	0.04	0.07	-0.02	-0.09	-0.26	-0.32	-0.42	-0.54	-0.60
9500	0.01	0.01	-0.03	-0.15	-0.25	-0.43	-0.50	-0.61	-0.77	-0.81
10000	-0.03	0.00	-0.10	-0.21	-0.35	-0.56	-0.66	-0.79	-0.98	-1.04
10500	-0.03	0.02	-0.05	-0.15	-0.29	-0.52	-0.63	-0.76	-0.95	-1.00
11000	-0.01	0.03	-0.01	-0.10	-0.24	-0.47	-0.58	-0.70	-0.92	-0.98
11500	0.00	0.02	-0.01	-0.13	-0.26	-0.50	-0.58	-0.72	-0.94	-0.99
12000	0.00	0.01	-0.04	-0.18	-0.30	-0.54	-0.60	-0.74	-0.94	-1.01
12500	0.00	0.02	-0.04	-0.17	-0.30	-0.55	-0.59	-0.74	-0.95	-0.94
12750	0.00	0.03	-0.03	-0.15	-0.29	-0.55	-0.58	-0.73	-0.95	-0.98
13000	0.01	0.04	-0.03	-0.13	-0.28	-0.55	-0.58	-0.73	-0.93	-1.01
13250	0.01	0.04	-0.02	-0.11	-0.27	-0.55	-0.59	-0.76	-0.99	-1.06
13500	0.01	0.05	-0.02	-0.10	-0.26	-0.54	-0.61	-0.78	-1.01	-1.07
13750	0.02	0.05	-0.01	-0.10	-0.25	-0.54	-0.61	-0.78	-1.03	-1.07
14000	0.02	0.05	-0.01	-0.10	-0.25	-0.53	-0.61	-0.78	-1.02	-1.07
14250	0.02	0.04	0.00	-0.10	-0.24	-0.52	-0.60	-0.76	-1.03	-1.08
14500	0.02	0.05	0.01	-0.10	-0.23	-0.51	-0.58	-0.75	-0.98	-1.10
14750	0.02	0.05	0.01	-0.10	-0.22	-0.51	-0.55	-0.72	-1.00	-1.01
15000	0.02	0.06	0.02	-0.09	-0.22	-0.50	-0.53	-0.72	-0.95	-0.97
15250	0.01	0.06	0.01	-0.09	-0.23	-0.52	-0.55	-0.72	-0.94	-0.99
15500	0.00	0.06	-0.01	-0.10	-0.25	-0.56	-0.58	-0.76	-0.98	-1.06
15750	0.00	0.07	-0.03	-0.11	-0.27	-0.59	-0.64	-0.82	-1.01	-1.06
16000	-0.01	0.07	-0.04	-0.12	-0.29	-0.62	-0.70	-0.89	-1.13	-1.24
16250	-0.01	0.07	-0.05	-0.13	-0.30	-0.64	-0.75	-0.95	-1.22	-1.29
16500	-0.01	0.07	-0.05	-0.13	-0.31	-0.65	-0.78	-0.99	-1.26	-1.33
16750	-0.01	0.07	-0.05	-0.13	-0.32	-0.66	-0.81	-1.00	-1.29	-1.38
17000	-0.01	0.07	-0.05	-0.12	-0.32	-0.67	-0.81	-1.02	-1.33	-1.39
17250	0.00	0.07	-0.05	-0.11	-0.32	-0.67	-0.81	-1.02	-1.35	-1.41
17500	0.00	0.07	-0.05	-0.10	-0.31	-0.67	-0.81	-1.00	-1.36	-1.39
17750	0.00	0.07	-0.05	-0.08	-0.30	-0.66	-0.80	-1.00	-1.29	-1.40
18000	0.01	0.07	-0.04	-0.07	-0.28	-0.64	-0.77	-0.97	-1.25	-1.36

Notes

- A. Performance and quality attributes and conditions not expressly stated in this specification document are intended to be excluded and do not form a part of this specification document.
- B. Electrical specifications and performance data contained in this specification document are based on Mini-Circuits' applicable established test performance criteria and measurement instructions.
- C. The parts covered by this specification document are subject to Mini-Circuits' standard limited warranty and terms and conditions (collectively, "Standard Terms"); Purchasers of this part are entitled to the rights and benefits contained therein. For a full statement of the Standard Terms and the exclusive rights and remedies thereunder, please visit Mini-Circuits' website at www.minicircuits.com/ACL/Store/terms.jsp



Programmable Attenuator

RCDAT-18G-63

Typical Performance Data @ 0°C

FREQUENCY (MHz)	Input VSWR (:1)									
	0.25 dB	1 dB	5 dB	10 dB	20 dB	30 dB	40 dB	50 dB	60 dB	63 dB
100	1.47	1.39	1.21	1.04	1.05	1.06	1.03	1.06	1.06	1.09
250	1.38	1.30	1.15	1.01	1.02	1.03	1.01	1.03	1.03	1.05
500	1.29	1.24	1.12	1.01	1.03	1.04	1.02	1.04	1.03	1.05
750	1.18	1.15	1.07	1.03	1.04	1.05	1.03	1.05	1.05	1.07
1000	1.06	1.06	1.03	1.05	1.06	1.06	1.04	1.06	1.06	1.08
1250	1.04	1.04	1.03	1.07	1.07	1.07	1.04	1.07	1.07	1.09
1500	1.12	1.07	1.05	1.08	1.07	1.08	1.05	1.08	1.07	1.10
1750	1.19	1.10	1.05	1.07	1.08	1.08	1.06	1.08	1.08	1.10
2000	1.23	1.12	1.05	1.07	1.08	1.09	1.06	1.08	1.08	1.11
2250	1.26	1.13	1.06	1.06	1.08	1.09	1.07	1.09	1.08	1.11
2500	1.27	1.15	1.07	1.07	1.08	1.09	1.07	1.09	1.08	1.11
2750	1.26	1.16	1.08	1.08	1.08	1.09	1.07	1.09	1.08	1.11
3000	1.23	1.15	1.08	1.08	1.08	1.09	1.07	1.09	1.08	1.11
3250	1.19	1.13	1.08	1.09	1.09	1.09	1.07	1.09	1.09	1.11
3500	1.13	1.10	1.07	1.09	1.09	1.09	1.08	1.09	1.09	1.11
3750	1.07	1.05	1.06	1.09	1.09	1.09	1.08	1.09	1.09	1.11
4000	1.06	1.03	1.06	1.09	1.10	1.10	1.09	1.10	1.10	1.11
4250	1.10	1.07	1.09	1.09	1.10	1.10	1.10	1.10	1.11	1.12
4500	1.17	1.13	1.12	1.10	1.11	1.11	1.11	1.11	1.11	1.12
4750	1.22	1.19	1.16	1.11	1.12	1.12	1.12	1.12	1.12	1.13
5000	1.26	1.23	1.19	1.13	1.13	1.12	1.12	1.12	1.12	1.13
5250	1.29	1.26	1.21	1.14	1.14	1.13	1.13	1.13	1.13	1.13
5500	1.32	1.28	1.23	1.14	1.14	1.13	1.14	1.13	1.14	1.13
6000	1.37	1.30	1.26	1.15	1.14	1.14	1.17	1.14	1.14	1.13
6500	1.42	1.31	1.27	1.16	1.14	1.14	1.18	1.14	1.14	1.12
7000	1.49	1.35	1.28	1.16	1.13	1.13	1.15	1.14	1.13	1.11
7500	1.37	1.26	1.22	1.13	1.12	1.13	1.12	1.13	1.12	1.11
8000	1.10	1.07	1.14	1.12	1.12	1.13	1.12	1.13	1.12	1.11
8500	1.16	1.17	1.16	1.13	1.12	1.13	1.13	1.13	1.12	1.12
9000	1.30	1.27	1.18	1.14	1.13	1.13	1.13	1.13	1.13	1.13
9500	1.28	1.22	1.14	1.13	1.14	1.14	1.12	1.14	1.14	1.14
10000	1.12	1.08	1.05	1.13	1.16	1.16	1.13	1.16	1.16	1.17
10500	1.03	1.08	1.06	1.16	1.18	1.17	1.16	1.17	1.18	1.19
11000	1.06	1.12	1.10	1.18	1.20	1.19	1.18	1.19	1.20	1.21
11500	1.03	1.06	1.09	1.19	1.22	1.20	1.19	1.20	1.22	1.23
12000	1.16	1.09	1.11	1.19	1.23	1.21	1.20	1.21	1.23	1.24
12500	1.34	1.26	1.19	1.19	1.22	1.21	1.20	1.21	1.23	1.23
12750	1.41	1.32	1.22	1.20	1.22	1.20	1.20	1.20	1.22	1.23
13000	1.42	1.35	1.24	1.20	1.21	1.20	1.20	1.20	1.21	1.22
13250	1.39	1.34	1.25	1.20	1.20	1.19	1.20	1.19	1.20	1.21
13500	1.33	1.30	1.24	1.19	1.19	1.18	1.20	1.18	1.19	1.20
13750	1.29	1.27	1.23	1.18	1.19	1.18	1.20	1.18	1.19	1.20
14000	1.28	1.26	1.23	1.18	1.18	1.18	1.20	1.18	1.18	1.19
14250	1.32	1.29	1.24	1.17	1.18	1.17	1.19	1.17	1.18	1.19
14500	1.39	1.34	1.27	1.17	1.17	1.16	1.18	1.17	1.17	1.18
14750	1.46	1.40	1.29	1.18	1.16	1.16	1.18	1.16	1.16	1.17
15000	1.52	1.45	1.31	1.18	1.15	1.15	1.17	1.15	1.15	1.17
15250	1.54	1.46	1.31	1.18	1.14	1.14	1.17	1.15	1.14	1.16
15500	1.51	1.44	1.30	1.17	1.13	1.13	1.16	1.14	1.12	1.14
15750	1.44	1.38	1.27	1.15	1.11	1.12	1.15	1.12	1.11	1.13
16000	1.37	1.32	1.24	1.13	1.09	1.10	1.14	1.11	1.09	1.11
16250	1.30	1.27	1.21	1.11	1.08	1.09	1.12	1.09	1.07	1.10
16500	1.25	1.22	1.18	1.09	1.06	1.07	1.10	1.07	1.06	1.08
16750	1.22	1.19	1.16	1.08	1.05	1.06	1.08	1.06	1.05	1.07
17000	1.18	1.17	1.14	1.07	1.06	1.06	1.08	1.06	1.05	1.07
17250	1.15	1.14	1.13	1.08	1.07	1.07	1.08	1.07	1.06	1.08
17500	1.11	1.11	1.13	1.09	1.08	1.08	1.08	1.08	1.08	1.10
17750	1.08	1.09	1.14	1.10	1.10	1.10	1.09	1.10	1.10	1.12
18000	1.11	1.10	1.16	1.12	1.12	1.13	1.11	1.12	1.12	1.14

Notes

- A. Performance and quality attributes and conditions not expressly stated in this specification document are intended to be excluded and do not form a part of this specification document.
- B. Electrical specifications and performance data contained in this specification document are based on Mini-Circuit's applicable established test performance criteria and measurement instructions.
- C. The parts covered by this specification document are subject to Mini-Circuit's standard limited warranty and terms and conditions (collectively, "Standard Terms"). Purchasers of this part are entitled to the rights and benefits contained therein. For a full statement of the Standard Terms and the exclusive rights and remedies thereunder, please visit Mini-Circuit's website at www.minicircuits.com/MC1Store/terms.jsp



Programmable Attenuator

RCDAT-18G-63

Typical Performance Data @ 0°C

FREQUENCY (MHz)	Output VSWR (:1)									
	0.25 dB	1 dB	5 dB	10 dB	20 dB	30 dB	40 dB	50 dB	60 dB	63 dB
100	1.45	1.49	1.37	1.38	1.31	1.30	1.11	1.11	1.11	1.11
250	1.36	1.40	1.30	1.32	1.26	1.25	1.07	1.07	1.07	1.07
500	1.29	1.33	1.27	1.28	1.25	1.24	1.07	1.07	1.07	1.07
750	1.19	1.23	1.21	1.21	1.22	1.22	1.07	1.07	1.07	1.07
1000	1.07	1.11	1.16	1.15	1.19	1.20	1.08	1.08	1.08	1.08
1250	1.03	1.04	1.11	1.10	1.16	1.17	1.09	1.09	1.09	1.09
1500	1.10	1.06	1.10	1.08	1.13	1.14	1.09	1.09	1.09	1.09
1750	1.18	1.13	1.11	1.10	1.12	1.12	1.09	1.09	1.09	1.09
2000	1.25	1.20	1.14	1.14	1.12	1.12	1.09	1.09	1.09	1.09
2250	1.30	1.25	1.16	1.17	1.13	1.12	1.08	1.08	1.08	1.08
2500	1.32	1.27	1.18	1.20	1.14	1.13	1.08	1.08	1.08	1.08
2750	1.30	1.25	1.18	1.20	1.16	1.15	1.07	1.07	1.07	1.07
3000	1.24	1.21	1.16	1.19	1.16	1.16	1.07	1.07	1.07	1.07
3250	1.17	1.14	1.14	1.15	1.16	1.16	1.07	1.07	1.07	1.07
3500	1.09	1.07	1.11	1.12	1.14	1.15	1.07	1.07	1.07	1.07
3750	1.05	1.04	1.10	1.09	1.13	1.13	1.07	1.07	1.07	1.07
4000	1.06	1.06	1.09	1.07	1.11	1.12	1.07	1.07	1.07	1.07
4250	1.10	1.11	1.10	1.08	1.09	1.10	1.07	1.07	1.07	1.07
4500	1.14	1.14	1.11	1.10	1.09	1.09	1.07	1.07	1.07	1.07
4750	1.15	1.16	1.12	1.13	1.10	1.09	1.07	1.07	1.07	1.07
5000	1.14	1.17	1.14	1.16	1.13	1.12	1.06	1.06	1.06	1.06
5250	1.14	1.18	1.17	1.20	1.17	1.16	1.05	1.05	1.05	1.05
5500	1.17	1.21	1.22	1.23	1.23	1.22	1.04	1.04	1.04	1.04
6000	1.26	1.27	1.31	1.28	1.31	1.32	1.03	1.03	1.03	1.03
6500	1.29	1.28	1.31	1.30	1.32	1.33	1.05	1.05	1.05	1.05
7000	1.32	1.29	1.26	1.27	1.25	1.25	1.08	1.08	1.08	1.08
7500	1.27	1.23	1.17	1.18	1.14	1.13	1.09	1.09	1.09	1.09
8000	1.16	1.13	1.07	1.08	1.05	1.04	1.10	1.10	1.10	1.10
8500	1.10	1.11	1.05	1.05	1.02	1.02	1.10	1.10	1.10	1.10
9000	1.14	1.16	1.10	1.09	1.06	1.06	1.10	1.10	1.10	1.10
9500	1.17	1.20	1.13	1.13	1.10	1.09	1.10	1.10	1.10	1.10
10000	1.16	1.18	1.12	1.14	1.11	1.10	1.11	1.11	1.11	1.11
10500	1.12	1.14	1.11	1.14	1.12	1.11	1.12	1.12	1.12	1.12
11000	1.04	1.07	1.10	1.13	1.13	1.12	1.12	1.12	1.12	1.12
11500	1.08	1.07	1.09	1.07	1.09	1.10	1.12	1.12	1.12	1.12
12000	1.17	1.15	1.13	1.12	1.11	1.11	1.10	1.10	1.10	1.10
12500	1.24	1.23	1.22	1.26	1.23	1.22	1.08	1.08	1.08	1.08
12750	1.27	1.27	1.27	1.30	1.28	1.27	1.07	1.07	1.07	1.07
13000	1.29	1.29	1.29	1.32	1.30	1.30	1.06	1.06	1.06	1.06
13250	1.29	1.28	1.29	1.30	1.30	1.30	1.05	1.05	1.05	1.05
13500	1.27	1.25	1.27	1.26	1.27	1.28	1.04	1.04	1.04	1.04
13750	1.23	1.22	1.24	1.21	1.24	1.25	1.04	1.04	1.04	1.04
14000	1.20	1.19	1.21	1.18	1.20	1.22	1.03	1.03	1.03	1.03
14250	1.18	1.19	1.20	1.18	1.19	1.19	1.03	1.03	1.03	1.03
14500	1.20	1.21	1.20	1.21	1.20	1.19	1.03	1.03	1.03	1.03
14750	1.24	1.26	1.24	1.26	1.23	1.22	1.03	1.03	1.03	1.03
15000	1.29	1.31	1.28	1.31	1.28	1.26	1.04	1.04	1.04	1.04
15250	1.32	1.34	1.31	1.35	1.32	1.31	1.04	1.04	1.04	1.04
15500	1.33	1.34	1.33	1.36	1.34	1.34	1.05	1.05	1.05	1.05
15750	1.31	1.32	1.33	1.35	1.35	1.35	1.05	1.05	1.05	1.05
16000	1.27	1.28	1.31	1.31	1.33	1.34	1.05	1.05	1.05	1.05
16250	1.24	1.24	1.28	1.26	1.29	1.31	1.06	1.06	1.06	1.06
16500	1.22	1.21	1.25	1.21	1.25	1.27	1.05	1.05	1.05	1.05
16750	1.20	1.19	1.21	1.18	1.21	1.22	1.05	1.05	1.05	1.05
17000	1.18	1.18	1.18	1.15	1.17	1.18	1.05	1.05	1.05	1.05
17250	1.15	1.15	1.14	1.12	1.13	1.13	1.06	1.06	1.06	1.06
17500	1.11	1.11	1.09	1.08	1.08	1.08	1.07	1.07	1.07	1.07
17750	1.06	1.07	1.06	1.04	1.05	1.05	1.09	1.09	1.09	1.09
18000	1.05	1.07	1.08	1.05	1.07	1.08	1.12	1.12	1.12	1.12

Notes

- A. Performance and quality attributes and conditions not expressly stated in this specification document are intended to be excluded and do not form a part of this specification document.
- B. Electrical specifications and performance data contained in this specification document are based on Mini-Circuit's applicable established test performance criteria and measurement instructions.
- C. The parts covered by this specification document are subject to Mini-Circuit's standard limited warranty and terms and conditions (collectively, "Standard Terms"); Purchasers of this part are entitled to the rights and benefits contained therein. For a full statement of the Standard Terms and the exclusive rights and remedies thereunder, please visit Mini-Circuit's website at www.minicircuits.com/ACLStore/terms.jsp



Programmable Attenuator

RCDAT-18G-63

Typical Performance Data @ 0°C

FREQUENCY (MHz)	I. Loss (dB)
100	3.01
250	3.12
500	3.28
750	3.43
1000	3.59
1250	3.68
1500	3.73
1750	3.75
2000	3.76
2250	3.80
2500	3.87
2750	3.96
3000	4.06
3250	4.15
3500	4.23
3750	4.29
4000	4.33
4250	4.36
4500	4.41
4750	4.47
5000	4.55
5250	4.62
5500	4.69
6000	4.81
6500	4.90
7000	4.94
7500	4.97
8000	5.15
8500	5.42
9000	5.54
9500	5.48
10000	5.42
10500	5.57
11000	5.76
11500	5.89
12000	6.02
12500	6.16
12750	6.22
13000	6.27
13250	6.31
13500	6.35
13750	6.39
14000	6.45
14250	6.53
14500	6.62
14750	6.70
15000	6.78
15250	6.84
15500	6.88
15750	6.89
16000	6.90
16250	6.92
16500	6.95
16750	7.00
17000	7.06
17250	7.13
17500	7.23
17750	7.33
18000	7.47

Notes

- A. Performance and quality attributes and conditions not expressly stated in this specification document are intended to be excluded and do not form a part of this specification document.
- B. Electrical specifications and performance data contained in this specification document are based on Mini-Circuit's applicable established test performance criteria and measurement instructions.
- C. The parts covered by this specification document are subject to Mini-Circuits standard limited warranty and terms and conditions (collectively, "Standard Terms"); Purchasers of this part are entitled to the rights and benefits contained therein. For a full statement of the Standard Terms and the exclusive rights and remedies thereunder, please visit Mini-Circuits' website at www.minicircuits.com/MC1Store/terms.jsp

Programmable Attenuator

RCDAT-18G-63

Typical Performance Data @ 25°C

FREQUENCY (MHz)	Attenuation relative to Insertion Loss (dB)									
	0.25 dB	1 dB	5 dB	10 dB	20 dB	30 dB	40 dB	50 dB	60 dB	63 dB
100	0.28	1.00	5.05	10.01	19.99	29.90	39.95	49.86	60.05	62.69
250	0.28	1.00	5.05	10.02	20.00	29.91	39.95	49.88	59.79	62.74
500	0.27	0.99	5.02	10.01	19.96	29.86	39.91	49.84	59.75	62.72
750	0.25	0.99	4.97	9.97	19.90	29.80	39.84	49.76	59.67	62.63
1000	0.24	0.98	4.93	9.94	19.84	29.74	39.77	49.69	59.60	62.54
1250	0.22	0.98	4.91	9.92	19.82	29.72	39.74	49.66	59.56	62.54
1500	0.20	0.98	4.93	9.94	19.85	29.75	39.76	49.67	59.61	62.56
1750	0.19	0.99	4.97	9.98	19.90	29.81	39.81	49.73	59.66	62.59
2000	0.18	0.99	5.00	10.01	19.95	29.87	39.87	49.79	59.70	62.65
2250	0.18	0.99	5.02	10.02	19.98	29.91	39.90	49.83	59.74	62.68
2500	0.18	0.99	5.01	10.01	19.98	29.91	39.91	49.83	59.76	62.70
2750	0.18	0.98	4.99	9.98	19.94	29.88	39.88	49.81	59.72	62.71
3000	0.18	0.98	4.96	9.96	19.91	29.85	39.85	49.77	59.72	62.69
3250	0.19	0.97	4.93	9.94	19.87	29.81	39.81	49.74	59.69	62.65
3500	0.20	0.97	4.92	9.93	19.86	29.80	39.80	49.73	59.68	62.65
3750	0.21	0.97	4.92	9.94	19.87	29.82	39.80	49.74	59.73	62.63
4000	0.22	0.98	4.94	9.96	19.90	29.86	39.83	49.77	59.75	62.70
4250	0.22	0.98	4.96	9.98	19.93	29.89	39.86	49.80	59.77	62.74
4500	0.23	0.98	4.98	9.98	19.95	29.92	39.88	49.82	59.81	62.78
4750	0.23	0.97	4.98	9.98	19.95	29.93	39.89	49.82	59.83	62.79
5000	0.22	0.97	4.97	9.96	19.94	29.93	39.88	49.82	59.81	62.78
5250	0.22	0.96	4.96	9.95	19.93	29.93	39.88	49.84	59.80	62.79
5500	0.22	0.96	4.96	9.94	19.92	29.93	39.88	49.84	59.83	62.80
6000	0.22	0.95	4.95	9.93	19.92	29.94	39.90	49.88	59.91	62.90
6500	0.22	0.95	4.95	9.93	19.93	29.97	39.96	49.94	59.99	63.00
7000	0.20	0.95	4.97	9.95	19.97	30.03	40.08	50.06	60.14	63.13
7500	0.18	0.96	5.02	10.01	20.05	30.13	40.20	50.20	60.26	63.26
8000	0.17	0.96	5.00	10.00	20.03	30.11	40.16	50.15	60.21	63.18
8500	0.17	0.94	4.91	9.93	19.93	30.01	40.02	50.02	60.09	63.10
9000	0.20	0.95	4.91	9.96	19.95	30.04	40.01	50.03	60.07	63.11
9500	0.25	0.98	5.02	10.08	20.11	30.22	40.20	50.23	60.33	63.33
10000	0.28	0.99	5.07	10.14	20.20	30.33	40.35	50.39	60.49	63.51
10500	0.28	0.97	5.02	10.06	20.13	30.27	40.31	50.34	60.49	63.53
11000	0.26	0.96	4.97	10.03	20.08	30.22	40.25	50.29	60.41	63.43
11500	0.25	0.97	4.99	10.06	20.11	30.26	40.26	50.30	60.40	63.49
12000	0.25	0.98	5.02	10.11	20.16	30.31	40.27	50.33	60.44	63.48
12500	0.25	0.97	5.02	10.10	20.16	30.32	40.26	50.33	60.45	63.48
12750	0.25	0.96	5.01	10.07	20.14	30.31	40.24	50.31	60.46	63.47
13000	0.24	0.95	5.00	10.05	20.12	30.30	40.24	50.31	60.46	63.45
13250	0.24	0.94	4.99	10.03	20.11	30.29	40.25	50.32	60.48	63.51
13500	0.23	0.94	4.99	10.02	20.10	30.29	40.27	50.34	60.49	63.55
13750	0.23	0.94	4.98	10.02	20.10	30.29	40.27	50.34	60.51	63.59
14000	0.23	0.94	4.98	10.02	20.09	30.28	40.27	50.34	60.50	63.57
14250	0.23	0.94	4.97	10.02	20.08	30.27	40.25	50.33	60.49	63.50
14500	0.23	0.94	4.96	10.01	20.07	30.26	40.23	50.32	60.51	63.54
14750	0.23	0.94	4.96	10.01	20.06	30.26	40.21	50.30	60.47	63.52
15000	0.24	0.93	4.96	10.01	20.06	30.26	40.20	50.29	60.45	63.44
15250	0.24	0.93	4.97	10.02	20.08	30.28	40.22	50.31	60.47	63.46
15500	0.25	0.93	4.99	10.03	20.10	30.32	40.27	50.36	60.51	63.56
15750	0.25	0.93	5.00	10.04	20.12	30.35	40.33	50.42	60.57	63.60
16000	0.26	0.92	5.01	10.05	20.14	30.37	40.38	50.49	60.66	63.72
16250	0.26	0.92	5.02	10.05	20.15	30.39	40.42	50.53	60.72	63.73
16500	0.26	0.92	5.02	10.06	20.16	30.40	40.46	50.57	60.76	63.78
16750	0.26	0.92	5.03	10.06	20.17	30.41	40.48	50.60	60.83	63.84
17000	0.25	0.92	5.03	10.05	20.17	30.42	40.49	50.61	60.88	63.88
17250	0.25	0.92	5.02	10.04	20.17	30.43	40.49	50.60	60.84	63.87
17500	0.25	0.92	5.02	10.02	20.16	30.42	40.49	50.60	60.84	63.88
17750	0.24	0.92	5.01	10.01	20.15	30.41	40.47	50.59	60.84	63.87
18000	0.23	0.92	5.00	9.99	20.13	30.39	40.44	50.56	60.78	63.76

Notes

- A. Performance and quality attributes and conditions not expressly stated in this specification document are intended to be excluded and do not form a part of this specification document.
- B. Electrical specifications and performance data contained in this specification document are based on Mini-Circuits' applicable established test performance criteria and measurement instructions.
- C. The parts covered by this specification document are subject to Mini-Circuits' standard limited warranty and terms and conditions (collectively, "Standard Terms"); Purchasers of this part are entitled to the rights and benefits contained therein. For a full statement of the Standard Terms and the exclusive rights and remedies thereunder, please visit Mini-Circuits' website at www.minicircuits.com/ACL/Store/terms.jsp



Programmable Attenuator

RCDAT-18G-63

Typical Performance Data @ 25°C

FREQUENCY (MHz)	Attenuation accuracy relative to nominal attenuation setting (dB)									
	0.25 dB	1 dB	5 dB	10 dB	20 dB	30 dB	40 dB	50 dB	60 dB	63 dB
100	-0.03	0.01	-0.05	-0.01	0.01	0.10	0.05	0.15	-0.05	0.32
250	-0.03	0.00	-0.05	-0.02	0.00	0.09	0.05	0.12	0.21	0.26
500	-0.02	0.01	-0.02	-0.01	0.05	0.14	0.09	0.17	0.26	0.28
750	0.00	0.01	0.03	0.03	0.10	0.20	0.16	0.24	0.33	0.37
1000	0.02	0.02	0.07	0.06	0.16	0.26	0.23	0.32	0.40	0.46
1250	0.03	0.02	0.09	0.08	0.18	0.28	0.26	0.34	0.44	0.46
1500	0.05	0.02	0.07	0.06	0.16	0.25	0.24	0.33	0.40	0.44
1750	0.06	0.01	0.03	0.02	0.10	0.19	0.19	0.27	0.34	0.41
2000	0.07	0.01	0.00	-0.01	0.05	0.13	0.13	0.21	0.31	0.35
2250	0.07	0.01	-0.02	-0.02	0.02	0.09	0.10	0.17	0.26	0.32
2500	0.07	0.01	-0.01	-0.01	0.03	0.09	0.09	0.17	0.24	0.30
2750	0.07	0.02	0.01	0.02	0.06	0.12	0.12	0.19	0.28	0.29
3000	0.07	0.02	0.04	0.05	0.10	0.16	0.16	0.23	0.28	0.31
3250	0.06	0.03	0.07	0.06	0.13	0.19	0.19	0.26	0.31	0.35
3500	0.05	0.03	0.08	0.07	0.14	0.20	0.20	0.27	0.32	0.35
3750	0.04	0.03	0.08	0.06	0.13	0.18	0.20	0.26	0.27	0.37
4000	0.03	0.02	0.06	0.04	0.10	0.15	0.17	0.24	0.26	0.31
4250	0.03	0.02	0.04	0.02	0.07	0.11	0.14	0.20	0.23	0.26
4500	0.02	0.02	0.02	0.02	0.05	0.08	0.12	0.18	0.19	0.22
4750	0.02	0.03	0.02	0.02	0.05	0.07	0.11	0.18	0.17	0.21
5000	0.03	0.03	0.03	0.04	0.06	0.07	0.12	0.18	0.20	0.22
5250	0.03	0.04	0.04	0.05	0.07	0.07	0.12	0.16	0.20	0.21
5500	0.03	0.04	0.04	0.06	0.08	0.07	0.12	0.16	0.17	0.20
6000	0.03	0.05	0.05	0.07	0.08	0.06	0.10	0.12	0.10	0.10
6500	0.03	0.05	0.05	0.07	0.07	0.04	0.04	0.06	0.02	0.01
7000	0.05	0.05	0.03	0.05	0.03	-0.03	-0.08	-0.06	-0.14	-0.13
7500	0.07	0.04	-0.02	-0.01	-0.05	-0.13	-0.20	-0.20	-0.26	-0.26
8000	0.08	0.05	0.01	0.00	-0.03	-0.11	-0.16	-0.15	-0.21	-0.18
8500	0.08	0.06	0.09	0.07	0.08	-0.01	-0.02	-0.02	-0.09	-0.10
9000	0.05	0.05	0.09	0.05	0.06	-0.04	-0.01	-0.03	-0.07	-0.11
9500	0.00	0.02	-0.02	-0.08	-0.11	-0.22	-0.20	-0.23	-0.33	-0.33
10000	-0.03	0.01	-0.07	-0.14	-0.20	-0.33	-0.35	-0.39	-0.49	-0.51
10500	-0.03	0.03	-0.02	-0.06	-0.13	-0.27	-0.31	-0.34	-0.49	-0.53
11000	-0.01	0.04	0.03	-0.03	-0.08	-0.22	-0.25	-0.29	-0.41	-0.43
11500	0.00	0.03	0.01	-0.06	-0.11	-0.26	-0.26	-0.30	-0.40	-0.49
12000	0.00	0.02	-0.02	-0.11	-0.16	-0.31	-0.27	-0.33	-0.44	-0.48
12500	0.00	0.03	-0.02	-0.10	-0.16	-0.32	-0.26	-0.33	-0.45	-0.48
12750	0.00	0.04	-0.01	-0.07	-0.14	-0.31	-0.24	-0.31	-0.46	-0.47
13000	0.01	0.05	0.00	-0.05	-0.12	-0.30	-0.24	-0.31	-0.46	-0.45
13250	0.01	0.06	0.01	-0.03	-0.11	-0.29	-0.25	-0.32	-0.48	-0.51
13500	0.02	0.06	0.01	-0.02	-0.10	-0.29	-0.27	-0.34	-0.49	-0.55
13750	0.02	0.06	0.02	-0.02	-0.10	-0.29	-0.27	-0.34	-0.51	-0.59
14000	0.02	0.06	0.02	-0.02	-0.09	-0.28	-0.27	-0.34	-0.50	-0.57
14250	0.02	0.06	0.03	-0.02	-0.08	-0.27	-0.25	-0.33	-0.49	-0.50
14500	0.02	0.06	0.04	-0.01	-0.07	-0.26	-0.23	-0.32	-0.51	-0.54
14750	0.02	0.06	0.04	-0.01	-0.06	-0.26	-0.21	-0.30	-0.47	-0.52
15000	0.01	0.07	0.04	-0.01	-0.06	-0.26	-0.20	-0.29	-0.45	-0.44
15250	0.01	0.07	0.03	-0.02	-0.08	-0.28	-0.22	-0.31	-0.47	-0.46
15500	0.00	0.07	0.01	-0.03	-0.10	-0.32	-0.27	-0.36	-0.51	-0.56
15750	0.00	0.07	0.00	-0.04	-0.12	-0.35	-0.33	-0.42	-0.57	-0.60
16000	-0.01	0.08	-0.01	-0.05	-0.14	-0.37	-0.38	-0.49	-0.66	-0.72
16250	-0.01	0.08	-0.02	-0.05	-0.15	-0.39	-0.42	-0.53	-0.72	-0.73
16500	-0.01	0.08	-0.02	-0.06	-0.16	-0.40	-0.46	-0.57	-0.76	-0.78
16750	-0.01	0.08	-0.03	-0.06	-0.17	-0.41	-0.48	-0.60	-0.83	-0.84
17000	0.00	0.08	-0.03	-0.05	-0.17	-0.42	-0.49	-0.61	-0.88	-0.88
17250	0.00	0.08	-0.02	-0.04	-0.17	-0.43	-0.49	-0.60	-0.84	-0.87
17500	0.00	0.08	-0.02	-0.02	-0.16	-0.42	-0.49	-0.60	-0.84	-0.88
17750	0.01	0.08	-0.01	-0.01	-0.15	-0.41	-0.47	-0.59	-0.84	-0.87
18000	0.02	0.08	0.00	0.01	-0.13	-0.39	-0.44	-0.56	-0.78	-0.76

Notes

- A. Performance and quality attributes and conditions not expressly stated in this specification document are intended to be excluded and do not form a part of this specification document.
- B. Electrical specifications and performance data contained in this specification document are based on Mini-Circuits' applicable established test performance criteria and measurement instructions.
- C. The parts covered by this specification document are subject to Mini-Circuits' standard limited warranty and terms and conditions (collectively, "Standard Terms"); Purchasers of this part are entitled to the rights and benefits contained therein. For a full statement of the Standard Terms and the exclusive rights and remedies thereunder, please visit Mini-Circuits' website at www.minicircuits.com/MC1Store/terms.jsp



Programmable Attenuator

RCDAT-18G-63

Typical Performance Data @ 25°C

FREQUENCY (MHz)	Input VSWR (:1)									
	0.25 dB	1 dB	5 dB	10 dB	20 dB	30 dB	40 dB	50 dB	60 dB	63 dB
100	1.51	1.42	1.23	1.05	1.04	1.05	1.05	1.05	1.04	1.08
250	1.42	1.33	1.17	1.02	1.01	1.02	1.02	1.02	1.02	1.04
500	1.32	1.26	1.13	1.01	1.02	1.03	1.02	1.03	1.03	1.05
750	1.20	1.16	1.09	1.02	1.04	1.04	1.03	1.04	1.04	1.06
1000	1.08	1.07	1.04	1.04	1.05	1.05	1.03	1.05	1.05	1.07
1250	1.05	1.03	1.03	1.06	1.05	1.06	1.03	1.06	1.05	1.08
1500	1.12	1.06	1.05	1.07	1.06	1.07	1.04	1.07	1.06	1.09
1750	1.19	1.10	1.06	1.06	1.06	1.07	1.05	1.07	1.07	1.09
2000	1.24	1.12	1.06	1.06	1.07	1.07	1.05	1.07	1.07	1.10
2250	1.27	1.14	1.07	1.05	1.07	1.08	1.06	1.08	1.07	1.10
2500	1.28	1.16	1.08	1.06	1.07	1.08	1.06	1.08	1.07	1.10
2750	1.27	1.17	1.09	1.07	1.07	1.08	1.06	1.08	1.08	1.10
3000	1.24	1.16	1.09	1.08	1.08	1.08	1.07	1.08	1.08	1.10
3250	1.19	1.14	1.09	1.09	1.08	1.08	1.07	1.08	1.08	1.10
3500	1.13	1.10	1.08	1.09	1.08	1.09	1.08	1.08	1.08	1.11
3750	1.07	1.06	1.07	1.09	1.09	1.09	1.09	1.09	1.09	1.11
4000	1.07	1.04	1.08	1.09	1.10	1.10	1.09	1.10	1.10	1.11
4250	1.12	1.09	1.10	1.09	1.11	1.10	1.10	1.10	1.11	1.12
4500	1.18	1.15	1.14	1.10	1.11	1.11	1.11	1.11	1.12	1.12
4750	1.23	1.20	1.17	1.12	1.13	1.12	1.12	1.12	1.13	1.13
5000	1.27	1.24	1.20	1.13	1.14	1.13	1.13	1.13	1.14	1.14
5250	1.30	1.27	1.23	1.15	1.15	1.14	1.14	1.14	1.14	1.14
5500	1.33	1.29	1.25	1.16	1.15	1.15	1.16	1.15	1.15	1.14
6000	1.39	1.31	1.28	1.17	1.16	1.15	1.19	1.16	1.16	1.14
6500	1.45	1.34	1.29	1.17	1.16	1.15	1.20	1.16	1.16	1.13
7000	1.53	1.38	1.31	1.18	1.15	1.15	1.17	1.15	1.15	1.13
7500	1.39	1.28	1.24	1.15	1.14	1.15	1.14	1.14	1.14	1.12
8000	1.11	1.08	1.15	1.13	1.13	1.14	1.13	1.14	1.13	1.12
8500	1.17	1.18	1.16	1.14	1.12	1.13	1.14	1.13	1.12	1.12
9000	1.30	1.27	1.18	1.14	1.12	1.13	1.13	1.13	1.12	1.13
9500	1.27	1.22	1.14	1.13	1.13	1.14	1.12	1.14	1.13	1.14
10000	1.12	1.08	1.04	1.12	1.15	1.15	1.12	1.15	1.15	1.16
10500	1.04	1.09	1.06	1.15	1.17	1.16	1.15	1.16	1.17	1.18
11000	1.06	1.12	1.10	1.18	1.20	1.19	1.18	1.19	1.20	1.21
11500	1.03	1.06	1.09	1.19	1.22	1.20	1.19	1.20	1.22	1.23
12000	1.17	1.10	1.12	1.19	1.23	1.22	1.20	1.21	1.23	1.24
12500	1.37	1.28	1.21	1.20	1.23	1.22	1.21	1.22	1.24	1.24
12750	1.44	1.35	1.26	1.21	1.23	1.22	1.22	1.22	1.23	1.24
13000	1.45	1.38	1.28	1.22	1.23	1.21	1.22	1.21	1.22	1.23
13250	1.41	1.36	1.28	1.21	1.22	1.20	1.22	1.20	1.21	1.22
13500	1.36	1.33	1.27	1.20	1.21	1.20	1.22	1.20	1.21	1.21
13750	1.32	1.30	1.26	1.20	1.20	1.19	1.22	1.19	1.20	1.21
14000	1.32	1.29	1.26	1.19	1.19	1.19	1.21	1.19	1.19	1.20
14250	1.37	1.33	1.28	1.19	1.19	1.18	1.21	1.19	1.19	1.20
14500	1.44	1.38	1.30	1.19	1.18	1.18	1.20	1.18	1.18	1.19
14750	1.51	1.44	1.32	1.19	1.17	1.17	1.20	1.17	1.17	1.18
15000	1.55	1.47	1.33	1.19	1.16	1.16	1.19	1.17	1.16	1.17
15250	1.55	1.47	1.33	1.19	1.15	1.15	1.18	1.16	1.15	1.16
15500	1.50	1.43	1.31	1.18	1.14	1.14	1.18	1.15	1.13	1.15
15750	1.44	1.38	1.28	1.16	1.12	1.13	1.17	1.14	1.12	1.14
16000	1.36	1.31	1.25	1.14	1.10	1.12	1.15	1.12	1.10	1.12
16250	1.30	1.26	1.22	1.12	1.08	1.10	1.12	1.10	1.08	1.10
16500	1.26	1.22	1.19	1.10	1.06	1.08	1.10	1.08	1.06	1.08
16750	1.22	1.19	1.17	1.08	1.05	1.07	1.08	1.07	1.05	1.07
17000	1.18	1.16	1.15	1.07	1.05	1.06	1.06	1.06	1.05	1.06
17250	1.14	1.13	1.13	1.07	1.05	1.06	1.06	1.06	1.05	1.07
17500	1.10	1.10	1.12	1.08	1.07	1.07	1.07	1.07	1.07	1.08
17750	1.08	1.08	1.13	1.09	1.09	1.09	1.08	1.09	1.09	1.11
18000	1.11	1.09	1.15	1.11	1.11	1.11	1.10	1.11	1.10	1.13

Notes

- A. Performance and quality attributes and conditions not expressly stated in this specification document are intended to be excluded and do not form a part of this specification document.
- B. Electrical specifications and performance data contained in this specification document are based on Mini-Circuit's applicable established test performance criteria and measurement instructions.
- C. The parts covered by this specification document are subject to Mini-Circuit's standard limited warranty and terms and conditions (collectively, "Standard Terms"). Purchasers of this part are entitled to the rights and benefits contained therein. For a full statement of the Standard Terms and the exclusive rights and remedies thereunder, please visit Mini-Circuit's website at www.minicircuits.com/MC1Store/terms.jsp



Programmable Attenuator

RCDAT-18G-63

Typical Performance Data @ 25°C

FREQUENCY (MHz)	Output VSWR (:1)									
	0.25 dB	1 dB	5 dB	10 dB	20 dB	30 dB	40 dB	50 dB	60 dB	63 dB
100	1.49	1.53	1.41	1.43	1.35	1.34	1.10	1.10	1.10	1.10
250	1.40	1.44	1.34	1.37	1.30	1.29	1.06	1.06	1.06	1.06
500	1.32	1.36	1.30	1.31	1.28	1.27	1.06	1.06	1.06	1.06
750	1.21	1.25	1.24	1.24	1.24	1.25	1.06	1.06	1.06	1.06
1000	1.09	1.13	1.17	1.17	1.21	1.21	1.07	1.07	1.07	1.07
1250	1.04	1.05	1.13	1.11	1.17	1.18	1.08	1.08	1.08	1.08
1500	1.10	1.07	1.11	1.10	1.14	1.15	1.08	1.08	1.08	1.08
1750	1.19	1.14	1.12	1.12	1.13	1.13	1.08	1.08	1.08	1.08
2000	1.26	1.21	1.15	1.15	1.13	1.13	1.08	1.08	1.08	1.08
2250	1.32	1.26	1.18	1.19	1.14	1.14	1.07	1.07	1.07	1.07
2500	1.34	1.28	1.20	1.22	1.16	1.15	1.07	1.07	1.07	1.07
2750	1.31	1.27	1.20	1.22	1.17	1.16	1.06	1.06	1.06	1.06
3000	1.25	1.22	1.18	1.20	1.17	1.17	1.06	1.06	1.06	1.06
3250	1.17	1.15	1.15	1.16	1.17	1.17	1.06	1.06	1.06	1.06
3500	1.10	1.08	1.12	1.12	1.15	1.16	1.06	1.06	1.06	1.06
3750	1.06	1.05	1.10	1.09	1.13	1.14	1.06	1.06	1.06	1.06
4000	1.07	1.07	1.10	1.08	1.12	1.13	1.07	1.07	1.07	1.07
4250	1.11	1.12	1.11	1.09	1.10	1.11	1.07	1.07	1.07	1.07
4500	1.15	1.16	1.12	1.11	1.10	1.10	1.07	1.07	1.07	1.07
4750	1.16	1.18	1.13	1.15	1.11	1.11	1.06	1.06	1.06	1.06
5000	1.15	1.18	1.15	1.18	1.14	1.13	1.06	1.06	1.06	1.06
5250	1.15	1.19	1.18	1.20	1.18	1.17	1.05	1.05	1.05	1.05
5500	1.18	1.21	1.22	1.23	1.23	1.23	1.05	1.05	1.05	1.05
6000	1.28	1.29	1.32	1.29	1.33	1.34	1.04	1.04	1.04	1.04
6500	1.32	1.31	1.34	1.33	1.35	1.36	1.06	1.06	1.06	1.06
7000	1.35	1.32	1.29	1.31	1.28	1.28	1.07	1.07	1.07	1.07
7500	1.28	1.25	1.19	1.20	1.16	1.15	1.08	1.08	1.08	1.08
8000	1.16	1.14	1.08	1.09	1.06	1.05	1.09	1.09	1.09	1.09
8500	1.09	1.10	1.04	1.05	1.02	1.01	1.08	1.08	1.08	1.08
9000	1.13	1.15	1.09	1.09	1.06	1.06	1.08	1.08	1.08	1.08
9500	1.18	1.20	1.14	1.14	1.11	1.10	1.09	1.09	1.09	1.09
10000	1.16	1.18	1.13	1.14	1.11	1.10	1.10	1.10	1.10	1.10
10500	1.13	1.15	1.12	1.15	1.13	1.12	1.12	1.12	1.12	1.12
11000	1.05	1.08	1.11	1.14	1.14	1.13	1.13	1.13	1.13	1.13
11500	1.09	1.09	1.10	1.08	1.10	1.11	1.12	1.12	1.12	1.12
12000	1.19	1.17	1.15	1.15	1.14	1.13	1.11	1.11	1.11	1.11
12500	1.26	1.25	1.25	1.28	1.26	1.25	1.09	1.09	1.09	1.09
12750	1.29	1.29	1.29	1.32	1.30	1.29	1.08	1.08	1.08	1.08
13000	1.31	1.30	1.31	1.32	1.32	1.31	1.07	1.07	1.07	1.07
13250	1.30	1.29	1.30	1.30	1.31	1.31	1.06	1.06	1.06	1.06
13500	1.28	1.27	1.28	1.27	1.28	1.29	1.06	1.06	1.06	1.06
13750	1.25	1.24	1.25	1.23	1.25	1.26	1.05	1.05	1.05	1.05
14000	1.22	1.22	1.23	1.21	1.23	1.24	1.05	1.05	1.05	1.05
14250	1.21	1.22	1.23	1.21	1.22	1.22	1.05	1.05	1.05	1.05
14500	1.23	1.25	1.24	1.24	1.23	1.23	1.06	1.06	1.06	1.06
14750	1.27	1.30	1.27	1.29	1.27	1.25	1.06	1.06	1.06	1.06
15000	1.32	1.33	1.30	1.33	1.30	1.29	1.06	1.06	1.06	1.06
15250	1.34	1.35	1.33	1.36	1.33	1.33	1.07	1.07	1.07	1.07
15500	1.33	1.34	1.34	1.36	1.35	1.35	1.07	1.07	1.07	1.07
15750	1.30	1.31	1.33	1.33	1.34	1.35	1.07	1.07	1.07	1.07
16000	1.26	1.27	1.30	1.30	1.32	1.33	1.07	1.07	1.07	1.07
16250	1.24	1.23	1.27	1.25	1.28	1.29	1.07	1.07	1.07	1.07
16500	1.22	1.21	1.24	1.21	1.24	1.25	1.06	1.06	1.06	1.06
16750	1.21	1.20	1.21	1.18	1.20	1.21	1.06	1.06	1.06	1.06
17000	1.19	1.19	1.18	1.16	1.17	1.18	1.06	1.06	1.06	1.06
17250	1.16	1.16	1.15	1.13	1.13	1.13	1.06	1.06	1.06	1.06
17500	1.12	1.12	1.10	1.09	1.09	1.08	1.08	1.08	1.08	1.08
17750	1.06	1.07	1.05	1.05	1.04	1.04	1.10	1.10	1.10	1.10
18000	1.05	1.07	1.07	1.04	1.06	1.07	1.13	1.13	1.13	1.13

Notes

- A. Performance and quality attributes and conditions not expressly stated in this specification document are intended to be excluded and do not form a part of this specification document.
- B. Electrical specifications and performance data contained in this specification document are based on Mini-Circuit's applicable established test performance criteria and measurement instructions.
- C. The parts covered by this specification document are subject to Mini-Circuit's standard limited warranty and terms and conditions (collectively, "Standard Terms"); Purchasers of this part are entitled to the rights and benefits contained therein. For a full statement of the Standard Terms and the exclusive rights and remedies thereunder, please visit Mini-Circuit's website at www.minicircuits.com/MC1Store/terms.jsp



Programmable Attenuator

RCDAT-18G-63

Typical Performance Data @ 25°C

FREQUENCY (MHz)	I. Loss (dB)
100	3.20
250	3.31
500	3.49
750	3.66
1000	3.84
1250	3.93
1500	3.99
1750	4.02
2000	4.03
2250	4.06
2500	4.14
2750	4.23
3000	4.35
3250	4.45
3500	4.54
3750	4.60
4000	4.64
4250	4.68
4500	4.73
4750	4.80
5000	4.88
5250	4.95
5500	5.02
6000	5.15
6500	5.25
7000	5.29
7500	5.33
8000	5.53
8500	5.82
9000	5.93
9500	5.85
10000	5.80
10500	5.98
11000	6.20
11500	6.34
12000	6.48
12500	6.63
12750	6.69
13000	6.75
13250	6.80
13500	6.84
13750	6.88
14000	6.95
14250	7.03
14500	7.13
14750	7.21
15000	7.28
15250	7.33
15500	7.36
15750	7.38
16000	7.39
16250	7.41
16500	7.45
16750	7.50
17000	7.57
17250	7.65
17500	7.75
17750	7.87
18000	8.03

Notes

- A. Performance and quality attributes and conditions not expressly stated in this specification document are intended to be excluded and do not form a part of this specification document.
- B. Electrical specifications and performance data contained in this specification document are based on Mini-Circuit's applicable established test performance criteria and measurement instructions.
- C. The parts covered by this specification document are subject to Mini-Circuits standard limited warranty and terms and conditions (collectively, "Standard Terms"); Purchasers of this part are entitled to the rights and benefits contained therein. For a full statement of the Standard Terms and the exclusive rights and remedies thereunder, please visit Mini-Circuits' website at www.minicircuits.com/MC1Store/terms.jsp

Programmable Attenuator

RCDAT-18G-63

Typical Performance Data @ 50°C

FREQUENCY (MHz)	Attenuation relative to Insertion Loss (dB)									
	0.25 dB	1 dB	5 dB	10 dB	20 dB	30 dB	40 dB	50 dB	60 dB	63 dB
100	0.29	0.99	5.04	9.97	19.90	29.75	39.73	49.59	59.25	62.65
250	0.28	0.99	5.04	9.98	19.91	29.76	39.75	49.62	59.47	62.42
500	0.27	0.99	5.01	9.96	19.87	29.72	39.71	49.58	59.43	62.36
750	0.26	0.98	4.96	9.93	19.80	29.65	39.63	49.50	59.35	62.30
1000	0.24	0.98	4.91	9.89	19.74	29.58	39.56	49.43	59.28	62.24
1250	0.22	0.97	4.89	9.88	19.72	29.56	39.52	49.40	59.25	62.18
1500	0.20	0.97	4.91	9.90	19.75	29.59	39.54	49.41	59.26	62.21
1750	0.19	0.98	4.95	9.93	19.80	29.66	39.60	49.46	59.31	62.27
2000	0.18	0.99	4.99	9.96	19.86	29.72	39.66	49.52	59.36	62.33
2250	0.18	0.99	5.01	9.97	19.89	29.75	39.69	49.55	59.40	62.34
2500	0.18	0.99	5.00	9.97	19.88	29.76	39.69	49.55	59.43	62.39
2750	0.18	0.98	4.98	9.94	19.85	29.73	39.67	49.53	59.42	62.36
3000	0.18	0.97	4.94	9.91	19.81	29.69	39.63	49.50	59.40	62.35
3250	0.19	0.97	4.91	9.89	19.77	29.65	39.59	49.47	59.37	62.28
3500	0.20	0.96	4.90	9.89	19.75	29.64	39.57	49.45	59.36	62.32
3750	0.21	0.97	4.91	9.90	19.77	29.66	39.58	49.46	59.35	62.34
4000	0.22	0.97	4.93	9.92	19.80	29.70	39.61	49.49	59.40	62.34
4250	0.23	0.97	4.95	9.94	19.83	29.74	39.64	49.52	59.43	62.37
4500	0.23	0.97	4.96	9.94	19.85	29.77	39.66	49.54	59.46	62.41
4750	0.23	0.97	4.96	9.93	19.85	29.78	39.67	49.56	59.47	62.42
5000	0.23	0.96	4.96	9.92	19.84	29.77	39.66	49.56	59.49	62.43
5250	0.22	0.96	4.95	9.90	19.83	29.77	39.66	49.55	59.50	62.45
5500	0.22	0.95	4.94	9.89	19.83	29.77	39.66	49.56	59.51	62.46
6000	0.22	0.95	4.94	9.88	19.82	29.78	39.68	49.59	59.53	62.52
6500	0.21	0.94	4.94	9.89	19.83	29.81	39.74	49.67	59.65	62.65
7000	0.20	0.95	4.96	9.91	19.88	29.88	39.87	49.80	59.84	62.83
7500	0.18	0.96	5.01	9.97	19.96	29.97	39.99	49.93	59.95	62.88
8000	0.17	0.95	4.98	9.96	19.93	29.95	39.94	49.88	59.86	62.87
8500	0.17	0.94	4.90	9.89	19.83	29.85	39.79	49.73	59.75	62.73
9000	0.20	0.95	4.90	9.92	19.85	29.88	39.79	49.74	59.73	62.73
9500	0.25	0.98	5.00	10.03	20.01	30.06	39.98	49.96	60.01	63.00
10000	0.29	0.98	5.05	10.09	20.10	30.16	40.12	50.10	60.15	63.15
10500	0.28	0.96	4.99	10.01	20.02	30.10	40.06	50.03	60.09	63.12
11000	0.27	0.96	4.95	9.98	19.97	30.05	40.00	49.98	60.03	63.08
11500	0.26	0.97	4.97	10.02	20.01	30.08	40.01	50.00	60.05	63.08
12000	0.25	0.98	5.00	10.06	20.05	30.13	40.03	50.01	60.07	63.10
12500	0.25	0.97	5.00	10.04	20.05	30.14	40.01	50.01	60.07	63.09
12750	0.25	0.96	4.99	10.02	20.03	30.14	40.00	50.01	60.07	63.02
13000	0.24	0.95	4.99	10.00	20.02	30.13	40.00	50.01	60.08	63.04
13250	0.24	0.94	4.98	9.98	20.01	30.13	40.01	50.01	60.12	63.14
13500	0.24	0.94	4.97	9.97	20.00	30.12	40.02	50.03	60.13	63.15
13750	0.23	0.94	4.97	9.97	19.99	30.12	40.03	50.03	60.13	63.17
14000	0.23	0.94	4.97	9.97	19.99	30.11	40.03	50.04	60.15	63.16
14250	0.23	0.94	4.96	9.97	19.98	30.10	40.01	50.03	60.15	63.17
14500	0.23	0.94	4.95	9.97	19.97	30.09	40.00	50.02	60.14	63.15
14750	0.23	0.93	4.94	9.96	19.96	30.08	39.97	49.98	60.08	63.08
15000	0.24	0.93	4.95	9.96	19.96	30.09	39.97	49.97	60.04	63.10
15250	0.24	0.92	4.95	9.96	19.97	30.11	39.99	50.00	60.09	63.10
15500	0.25	0.92	4.97	9.98	19.99	30.14	40.03	50.05	60.11	63.13
15750	0.25	0.92	4.99	9.99	20.02	30.17	40.08	50.12	60.24	63.18
16000	0.26	0.92	5.00	10.00	20.03	30.20	40.14	50.19	60.28	63.23
16250	0.26	0.92	5.01	10.01	20.05	30.21	40.17	50.22	60.33	63.32
16500	0.26	0.92	5.01	10.01	20.05	30.23	40.21	50.26	60.40	63.39
16750	0.26	0.92	5.01	10.01	20.06	30.24	40.24	50.29	60.47	63.44
17000	0.25	0.92	5.01	10.01	20.07	30.25	40.26	50.32	60.47	63.49
17250	0.25	0.92	5.01	10.00	20.06	30.25	40.26	50.32	60.46	63.47
17500	0.25	0.91	5.01	9.98	20.06	30.25	40.25	50.30	60.49	63.50
17750	0.24	0.92	5.00	9.96	20.04	30.24	40.23	50.29	60.44	63.43
18000	0.23	0.92	4.99	9.95	20.02	30.22	40.19	50.26	60.38	63.42

Notes

- A. Performance and quality attributes and conditions not expressly stated in this specification document are intended to be excluded and do not form a part of this specification document.
- B. Electrical specifications and performance data contained in this specification document are based on Mini-Circuits' applicable established test performance criteria and measurement instructions.
- C. The parts covered by this specification document are subject to Mini-Circuits' standard limited warranty and terms and conditions (collectively, "Standard Terms"); Purchasers of this part are entitled to the rights and benefits contained therein. For a full statement of the Standard Terms and the exclusive rights and remedies thereunder, please visit Mini-Circuits' website at www.minicircuits.com/ACL/Store/terms.jsp



Programmable Attenuator

RCDAT-18G-63

Typical Performance Data @ 50°C

FREQUENCY (MHz)	Attenuation accuracy relative to nominal attenuation setting (dB)									
	0.25 dB	1 dB	5 dB	10 dB	20 dB	30 dB	40 dB	50 dB	60 dB	63 dB
100	-0.04	0.01	-0.04	0.04	0.10	0.25	0.27	0.42	0.75	0.36
250	-0.03	0.01	-0.04	0.02	0.09	0.24	0.25	0.38	0.53	0.58
500	-0.02	0.01	-0.01	0.04	0.14	0.29	0.29	0.43	0.57	0.65
750	-0.01	0.02	0.04	0.07	0.20	0.35	0.37	0.50	0.65	0.70
1000	0.01	0.03	0.09	0.11	0.26	0.42	0.45	0.57	0.72	0.76
1250	0.03	0.03	0.11	0.12	0.28	0.44	0.48	0.60	0.75	0.82
1500	0.05	0.03	0.09	0.10	0.26	0.41	0.46	0.59	0.75	0.79
1750	0.06	0.02	0.05	0.07	0.20	0.34	0.40	0.54	0.69	0.73
2000	0.07	0.01	0.01	0.04	0.15	0.28	0.35	0.49	0.64	0.68
2250	0.07	0.01	-0.01	0.03	0.11	0.25	0.31	0.45	0.60	0.66
2500	0.07	0.01	0.00	0.04	0.12	0.25	0.31	0.45	0.58	0.62
2750	0.07	0.02	0.02	0.06	0.15	0.27	0.33	0.47	0.58	0.64
3000	0.07	0.03	0.06	0.09	0.20	0.32	0.37	0.50	0.61	0.65
3250	0.06	0.03	0.09	0.11	0.23	0.35	0.41	0.53	0.63	0.72
3500	0.05	0.04	0.10	0.12	0.25	0.36	0.43	0.55	0.64	0.69
3750	0.04	0.03	0.09	0.10	0.23	0.34	0.42	0.54	0.65	0.66
4000	0.03	0.03	0.08	0.08	0.20	0.31	0.39	0.51	0.60	0.67
4250	0.02	0.03	0.05	0.06	0.17	0.26	0.36	0.48	0.57	0.63
4500	0.02	0.03	0.04	0.06	0.15	0.23	0.34	0.46	0.54	0.59
4750	0.02	0.03	0.04	0.07	0.15	0.22	0.33	0.44	0.53	0.58
5000	0.02	0.04	0.04	0.09	0.16	0.23	0.34	0.44	0.52	0.58
5250	0.03	0.04	0.05	0.10	0.17	0.23	0.34	0.45	0.50	0.55
5500	0.03	0.05	0.06	0.11	0.17	0.23	0.34	0.44	0.49	0.54
6000	0.03	0.05	0.06	0.12	0.18	0.22	0.32	0.41	0.47	0.48
6500	0.04	0.06	0.06	0.11	0.17	0.19	0.26	0.34	0.35	0.36
7000	0.05	0.05	0.04	0.09	0.13	0.13	0.14	0.21	0.17	0.18
7500	0.07	0.05	-0.01	0.03	0.05	0.03	0.01	0.08	0.06	0.12
8000	0.08	0.05	0.02	0.05	0.08	0.05	0.06	0.13	0.14	0.14
8500	0.08	0.06	0.11	0.11	0.17	0.15	0.21	0.27	0.26	0.27
9000	0.05	0.05	0.10	0.09	0.15	0.13	0.22	0.26	0.27	0.27
9500	0.00	0.03	0.00	-0.03	-0.01	-0.06	0.03	0.05	-0.01	0.00
10000	-0.04	0.02	-0.05	-0.09	-0.10	-0.16	-0.12	-0.10	-0.15	-0.15
10500	-0.03	0.04	0.01	-0.01	-0.02	-0.10	-0.06	-0.03	-0.09	-0.12
11000	-0.02	0.04	0.05	0.02	0.03	-0.05	0.00	0.02	-0.03	-0.08
11500	-0.01	0.03	0.03	-0.02	-0.01	-0.08	-0.01	0.01	-0.05	-0.08
12000	0.00	0.02	0.00	-0.06	-0.05	-0.13	-0.03	-0.01	-0.07	-0.10
12500	0.00	0.03	0.00	-0.04	-0.05	-0.14	-0.01	-0.01	-0.07	-0.09
12750	0.00	0.04	0.01	-0.02	-0.03	-0.14	0.00	-0.01	-0.07	-0.02
13000	0.01	0.05	0.02	0.00	-0.02	-0.13	0.00	-0.01	-0.08	-0.04
13250	0.01	0.06	0.02	0.02	-0.01	-0.13	-0.01	-0.01	-0.12	-0.14
13500	0.01	0.06	0.03	0.03	0.00	-0.12	-0.02	-0.03	-0.13	-0.15
13750	0.02	0.06	0.03	0.03	0.01	-0.12	-0.03	-0.03	-0.13	-0.17
14000	0.02	0.06	0.03	0.03	0.01	-0.11	-0.03	-0.04	-0.15	-0.16
14250	0.02	0.06	0.04	0.03	0.02	-0.10	-0.01	-0.03	-0.15	-0.17
14500	0.02	0.06	0.05	0.03	0.03	-0.09	0.01	-0.02	-0.14	-0.15
14750	0.02	0.07	0.06	0.04	0.04	-0.08	0.03	0.02	-0.08	-0.08
15000	0.01	0.07	0.06	0.04	0.04	-0.09	0.03	0.03	-0.04	-0.10
15250	0.01	0.08	0.05	0.04	0.03	-0.11	0.01	0.00	-0.09	-0.10
15500	0.00	0.08	0.03	0.02	0.01	-0.14	-0.03	-0.05	-0.11	-0.13
15750	0.00	0.08	0.01	0.01	-0.02	-0.17	-0.08	-0.12	-0.24	-0.18
16000	-0.01	0.08	0.00	0.00	-0.03	-0.20	-0.14	-0.19	-0.28	-0.23
16250	-0.01	0.08	-0.01	-0.01	-0.05	-0.21	-0.17	-0.22	-0.33	-0.32
16500	-0.01	0.08	-0.01	-0.01	-0.05	-0.23	-0.21	-0.26	-0.40	-0.39
16750	-0.01	0.08	-0.01	-0.01	-0.06	-0.24	-0.24	-0.29	-0.47	-0.44
17000	0.00	0.08	-0.01	-0.01	-0.07	-0.25	-0.26	-0.32	-0.47	-0.49
17250	0.00	0.08	-0.01	0.00	-0.06	-0.25	-0.26	-0.32	-0.46	-0.47
17500	0.00	0.09	-0.01	0.02	-0.06	-0.25	-0.25	-0.30	-0.49	-0.50
17750	0.01	0.08	0.00	0.04	-0.04	-0.24	-0.23	-0.29	-0.44	-0.43
18000	0.02	0.08	0.01	0.05	-0.02	-0.22	-0.19	-0.26	-0.38	-0.42

Notes

- A. Performance and quality attributes and conditions not expressly stated in this specification document are intended to be excluded and do not form a part of this specification document.
- B. Electrical specifications and performance data contained in this specification document are based on Mini-Circuit's applicable established test performance criteria and measurement instructions.
- C. The parts covered by this specification document are subject to Mini-Circuit's standard limited warranty and terms and conditions (collectively, "Standard Terms"); Purchasers of this part are entitled to the rights and benefits contained therein. For a full statement of the Standard Terms and the exclusive rights and remedies thereunder, please visit Mini-Circuit's website at www.minicircuits.com/MC1Store/terms.jsp



Programmable Attenuator

RCDAT-18G-63

Typical Performance Data @ 50°C

FREQUENCY (MHz)	Input VSWR (:1)									
	0.25 dB	1 dB	5 dB	10 dB	20 dB	30 dB	40 dB	50 dB	60 dB	63 dB
100	1.54	1.44	1.24	1.06	1.02	1.04	1.06	1.04	1.03	1.07
250	1.44	1.35	1.18	1.02	1.01	1.02	1.03	1.01	1.01	1.04
500	1.35	1.28	1.15	1.01	1.02	1.03	1.03	1.03	1.02	1.04
750	1.22	1.18	1.10	1.01	1.03	1.04	1.03	1.04	1.04	1.05
1000	1.09	1.07	1.05	1.03	1.04	1.05	1.03	1.05	1.04	1.06
1250	1.06	1.02	1.04	1.05	1.05	1.06	1.03	1.06	1.05	1.08
1500	1.12	1.06	1.05	1.06	1.06	1.06	1.03	1.06	1.06	1.08
1750	1.20	1.10	1.06	1.06	1.06	1.07	1.04	1.07	1.06	1.09
2000	1.25	1.13	1.07	1.05	1.06	1.07	1.05	1.07	1.06	1.09
2250	1.28	1.15	1.08	1.05	1.06	1.07	1.05	1.07	1.07	1.10
2500	1.29	1.17	1.09	1.06	1.07	1.07	1.06	1.07	1.07	1.10
2750	1.28	1.18	1.10	1.07	1.07	1.08	1.06	1.07	1.07	1.10
3000	1.25	1.17	1.10	1.08	1.07	1.08	1.06	1.08	1.07	1.10
3250	1.20	1.14	1.09	1.08	1.08	1.08	1.07	1.08	1.08	1.10
3500	1.13	1.10	1.08	1.09	1.08	1.08	1.08	1.08	1.08	1.11
3750	1.08	1.06	1.07	1.09	1.09	1.09	1.09	1.09	1.09	1.11
4000	1.07	1.05	1.08	1.09	1.10	1.10	1.10	1.10	1.10	1.12
4250	1.12	1.09	1.11	1.09	1.11	1.11	1.11	1.11	1.11	1.12
4500	1.19	1.15	1.14	1.11	1.12	1.12	1.12	1.12	1.12	1.13
4750	1.24	1.21	1.18	1.12	1.13	1.13	1.13	1.13	1.13	1.14
5000	1.28	1.25	1.21	1.14	1.14	1.14	1.14	1.14	1.14	1.14
5250	1.31	1.28	1.24	1.15	1.15	1.15	1.15	1.14	1.15	1.15
5500	1.34	1.30	1.26	1.16	1.16	1.15	1.17	1.15	1.16	1.15
6000	1.40	1.32	1.29	1.17	1.17	1.16	1.20	1.16	1.17	1.15
6500	1.47	1.35	1.31	1.18	1.17	1.16	1.20	1.16	1.16	1.14
7000	1.53	1.39	1.31	1.18	1.16	1.16	1.18	1.16	1.16	1.13
7500	1.39	1.28	1.24	1.15	1.14	1.15	1.14	1.14	1.14	1.12
8000	1.11	1.07	1.14	1.12	1.12	1.13	1.13	1.13	1.12	1.11
8500	1.15	1.16	1.15	1.13	1.11	1.12	1.12	1.12	1.11	1.11
9000	1.29	1.26	1.17	1.13	1.11	1.12	1.12	1.12	1.11	1.12
9500	1.26	1.21	1.13	1.12	1.12	1.12	1.11	1.12	1.12	1.13
10000	1.11	1.08	1.03	1.11	1.13	1.14	1.11	1.14	1.14	1.15
10500	1.05	1.10	1.06	1.15	1.16	1.16	1.14	1.16	1.16	1.18
11000	1.06	1.13	1.10	1.17	1.19	1.18	1.17	1.18	1.19	1.20
11500	1.03	1.06	1.10	1.18	1.21	1.20	1.18	1.19	1.21	1.22
12000	1.19	1.11	1.13	1.18	1.22	1.21	1.19	1.20	1.22	1.23
12500	1.38	1.29	1.22	1.20	1.22	1.21	1.20	1.21	1.22	1.23
12750	1.44	1.36	1.26	1.21	1.22	1.21	1.21	1.21	1.22	1.23
13000	1.45	1.38	1.28	1.21	1.22	1.21	1.22	1.21	1.22	1.23
13250	1.42	1.37	1.29	1.21	1.22	1.20	1.22	1.20	1.21	1.22
13500	1.37	1.33	1.28	1.21	1.21	1.20	1.22	1.20	1.21	1.22
13750	1.33	1.30	1.27	1.20	1.20	1.19	1.22	1.20	1.20	1.21
14000	1.33	1.30	1.27	1.20	1.20	1.19	1.22	1.19	1.20	1.21
14250	1.37	1.33	1.28	1.20	1.19	1.19	1.21	1.19	1.19	1.20
14500	1.44	1.39	1.31	1.20	1.19	1.19	1.21	1.19	1.19	1.20
14750	1.51	1.44	1.33	1.20	1.18	1.18	1.21	1.18	1.18	1.19
15000	1.56	1.48	1.34	1.21	1.18	1.18	1.20	1.18	1.17	1.18
15250	1.55	1.48	1.34	1.20	1.16	1.17	1.20	1.17	1.16	1.17
15500	1.51	1.44	1.32	1.19	1.15	1.16	1.19	1.16	1.15	1.16
15750	1.44	1.38	1.29	1.17	1.13	1.14	1.18	1.14	1.13	1.14
16000	1.37	1.32	1.25	1.15	1.11	1.12	1.16	1.13	1.11	1.12
16250	1.31	1.27	1.22	1.12	1.09	1.11	1.13	1.11	1.09	1.10
16500	1.26	1.23	1.19	1.10	1.07	1.09	1.11	1.09	1.07	1.09
16750	1.22	1.20	1.17	1.09	1.06	1.07	1.09	1.08	1.06	1.07
17000	1.19	1.17	1.15	1.08	1.06	1.07	1.07	1.07	1.05	1.07
17250	1.15	1.14	1.14	1.08	1.06	1.07	1.07	1.07	1.06	1.08
17500	1.11	1.11	1.13	1.09	1.08	1.08	1.08	1.08	1.08	1.09
17750	1.09	1.09	1.14	1.10	1.10	1.10	1.09	1.10	1.10	1.12
18000	1.11	1.10	1.17	1.12	1.12	1.13	1.11	1.13	1.12	1.14

Notes

- A. Performance and quality attributes and conditions not expressly stated in this specification document are intended to be excluded and do not form a part of this specification document.
- B. Electrical specifications and performance data contained in this specification document are based on Mini-Circuits' applicable established test performance criteria and measurement instructions.
- C. The parts covered by this specification document are subject to Mini-Circuits' standard limited warranty and terms and conditions (collectively, "Standard Terms"). Purchasers of this part are entitled to the rights and benefits contained therein. For a full statement of the Standard Terms and the exclusive rights and remedies thereunder, please visit Mini-Circuits' website at www.minicircuits.com/ACL/Store/terms.jsp



Programmable Attenuator

RCDAT-18G-63

Typical Performance Data @ 50°C

FREQUENCY (MHz)	Output VSWR (:1)									
	0.25 dB	1 dB	5 dB	10 dB	20 dB	30 dB	40 dB	50 dB	60 dB	63 dB
100	1.52	1.56	1.43	1.46	1.38	1.37	1.09	1.09	1.09	1.09
250	1.43	1.47	1.37	1.40	1.33	1.32	1.05	1.05	1.05	1.05
500	1.34	1.39	1.32	1.34	1.30	1.30	1.05	1.05	1.05	1.05
750	1.23	1.27	1.26	1.26	1.26	1.26	1.06	1.06	1.06	1.06
1000	1.11	1.14	1.19	1.18	1.22	1.23	1.06	1.06	1.06	1.06
1250	1.05	1.06	1.14	1.12	1.18	1.19	1.07	1.07	1.07	1.07
1500	1.11	1.07	1.12	1.10	1.15	1.16	1.08	1.08	1.08	1.08
1750	1.19	1.15	1.13	1.12	1.13	1.14	1.08	1.08	1.08	1.08
2000	1.27	1.22	1.16	1.16	1.14	1.14	1.08	1.08	1.08	1.08
2250	1.32	1.27	1.19	1.20	1.15	1.15	1.07	1.07	1.07	1.07
2500	1.34	1.29	1.20	1.23	1.17	1.16	1.07	1.07	1.07	1.07
2750	1.32	1.27	1.20	1.23	1.18	1.17	1.06	1.06	1.06	1.06
3000	1.26	1.22	1.18	1.21	1.18	1.17	1.06	1.06	1.06	1.06
3250	1.18	1.15	1.16	1.17	1.17	1.17	1.06	1.06	1.06	1.06
3500	1.11	1.09	1.13	1.13	1.16	1.16	1.06	1.06	1.06	1.06
3750	1.06	1.05	1.11	1.09	1.14	1.15	1.06	1.06	1.06	1.06
4000	1.08	1.08	1.11	1.08	1.12	1.13	1.07	1.07	1.07	1.07
4250	1.12	1.13	1.12	1.10	1.11	1.12	1.07	1.07	1.07	1.07
4500	1.16	1.16	1.13	1.12	1.11	1.11	1.07	1.07	1.07	1.07
4750	1.17	1.18	1.14	1.16	1.12	1.11	1.07	1.07	1.07	1.07
5000	1.16	1.19	1.15	1.18	1.15	1.14	1.06	1.06	1.06	1.06
5250	1.16	1.19	1.18	1.21	1.19	1.18	1.06	1.06	1.06	1.06
5500	1.18	1.22	1.23	1.23	1.24	1.23	1.05	1.05	1.05	1.05
6000	1.28	1.29	1.32	1.29	1.33	1.34	1.05	1.05	1.05	1.05
6500	1.34	1.33	1.36	1.34	1.36	1.37	1.05	1.05	1.05	1.05
7000	1.36	1.33	1.31	1.32	1.30	1.29	1.07	1.07	1.07	1.07
7500	1.29	1.26	1.20	1.22	1.18	1.17	1.08	1.08	1.08	1.08
8000	1.17	1.15	1.09	1.10	1.07	1.07	1.08	1.08	1.08	1.08
8500	1.09	1.10	1.04	1.05	1.02	1.01	1.08	1.08	1.08	1.08
9000	1.11	1.13	1.08	1.08	1.05	1.05	1.08	1.08	1.08	1.08
9500	1.17	1.19	1.13	1.13	1.10	1.09	1.08	1.08	1.08	1.08
10000	1.18	1.20	1.14	1.15	1.12	1.11	1.09	1.09	1.09	1.09
10500	1.15	1.17	1.14	1.16	1.14	1.13	1.11	1.11	1.11	1.11
11000	1.06	1.09	1.12	1.14	1.14	1.14	1.12	1.12	1.12	1.12
11500	1.09	1.09	1.10	1.08	1.10	1.11	1.12	1.12	1.12	1.12
12000	1.18	1.17	1.15	1.15	1.14	1.13	1.11	1.11	1.11	1.11
12500	1.26	1.26	1.25	1.28	1.26	1.25	1.10	1.10	1.10	1.10
12750	1.29	1.29	1.29	1.31	1.30	1.29	1.09	1.09	1.09	1.09
13000	1.31	1.31	1.31	1.33	1.32	1.32	1.08	1.08	1.08	1.08
13250	1.31	1.30	1.31	1.31	1.32	1.32	1.08	1.08	1.08	1.08
13500	1.29	1.28	1.30	1.28	1.30	1.31	1.07	1.07	1.07	1.07
13750	1.27	1.25	1.27	1.25	1.27	1.28	1.07	1.07	1.07	1.07
14000	1.24	1.24	1.25	1.23	1.25	1.25	1.06	1.06	1.06	1.06
14250	1.23	1.24	1.24	1.23	1.23	1.24	1.06	1.06	1.06	1.06
14500	1.24	1.26	1.25	1.25	1.24	1.24	1.06	1.06	1.06	1.06
14750	1.27	1.29	1.27	1.29	1.27	1.26	1.06	1.06	1.06	1.06
15000	1.31	1.33	1.30	1.32	1.30	1.29	1.07	1.07	1.06	1.06
15250	1.33	1.34	1.32	1.34	1.32	1.31	1.07	1.07	1.07	1.07
15500	1.32	1.33	1.33	1.34	1.33	1.33	1.07	1.06	1.06	1.06
15750	1.29	1.30	1.32	1.33	1.33	1.34	1.06	1.06	1.06	1.06
16000	1.27	1.27	1.30	1.30	1.31	1.32	1.06	1.06	1.06	1.06
16250	1.25	1.24	1.28	1.26	1.29	1.30	1.06	1.06	1.06	1.06
16500	1.24	1.23	1.26	1.23	1.26	1.27	1.05	1.05	1.05	1.05
16750	1.23	1.22	1.23	1.20	1.23	1.24	1.05	1.05	1.05	1.05
17000	1.21	1.21	1.20	1.18	1.19	1.20	1.05	1.05	1.05	1.05
17250	1.18	1.18	1.17	1.15	1.15	1.16	1.06	1.06	1.06	1.06
17500	1.13	1.13	1.11	1.11	1.10	1.10	1.08	1.08	1.08	1.08
17750	1.07	1.08	1.06	1.06	1.05	1.05	1.10	1.10	1.10	1.10
18000	1.05	1.07	1.06	1.05	1.06	1.06	1.12	1.12	1.12	1.12

Notes

- A. Performance and quality attributes and conditions not expressly stated in this specification document are intended to be excluded and do not form a part of this specification document.
- B. Electrical specifications and performance data contained in this specification document are based on Mini-Circuit's applicable established test performance criteria and measurement instructions.
- C. The parts covered by this specification document are subject to Mini-Circuit's standard limited warranty and terms and conditions (collectively, "Standard Terms"); Purchasers of this part are entitled to the rights and benefits contained therein. For a full statement of the Standard Terms and the exclusive rights and remedies thereunder, please visit Mini-Circuit's website at www.minicircuits.com/ACLStore/terms.jsp



Programmable Attenuator

RCDAT-18G-63

Typical Performance Data @ 50°C

FREQUENCY (MHz)	I. Loss (dB)
100	3.33
250	3.44
500	3.63
750	3.81
1000	3.99
1250	4.10
1500	4.16
1750	4.18
2000	4.19
2250	4.23
2500	4.31
2750	4.41
3000	4.53
3250	4.63
3500	4.72
3750	4.78
4000	4.82
4250	4.86
4500	4.92
4750	4.98
5000	5.07
5250	5.14
5500	5.21
6000	5.34
6500	5.43
7000	5.47
7500	5.52
8000	5.73
8500	6.03
9000	6.13
9500	6.04
10000	6.00
10500	6.19
11000	6.42
11500	6.57
12000	6.71
12500	6.85
12750	6.92
13000	6.98
13250	7.03
13500	7.07
13750	7.12
14000	7.18
14250	7.26
14500	7.35
14750	7.43
15000	7.51
15250	7.56
15500	7.58
15750	7.60
16000	7.62
16250	7.64
16500	7.68
16750	7.73
17000	7.79
17250	7.88
17500	7.99
17750	8.11
18000	8.28

Notes

- A. Performance and quality attributes and conditions not expressly stated in this specification document are intended to be excluded and do not form a part of this specification document.
- B. Electrical specifications and performance data contained in this specification document are based on Mini-Circuit's applicable established test performance criteria and measurement instructions.
- C. The parts covered by this specification document are subject to Mini-Circuits standard limited warranty and terms and conditions (collectively, "Standard Terms"); Purchasers of this part are entitled to the rights and benefits contained therein. For a full statement of the Standard Terms and the exclusive rights and remedies thereunder, please visit Mini-Circuits' website at www.minicircuits.com/MC1Store/terms.jsp

Programmable Attenuator

RCDAT-18G-63

Typical Performance Curves @ 0°C

Attenuation Accuracy vs. Frequency over Attenuation settings

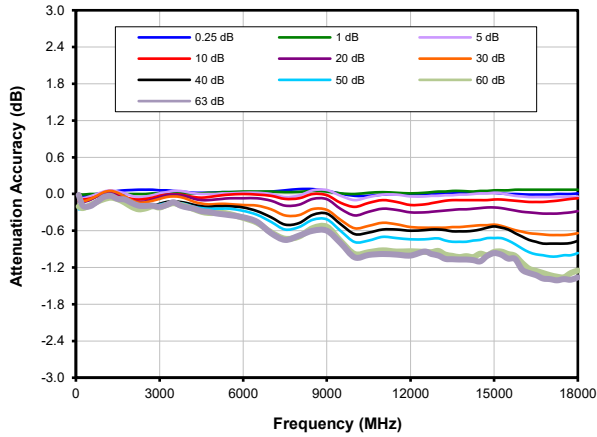

Insertion Loss

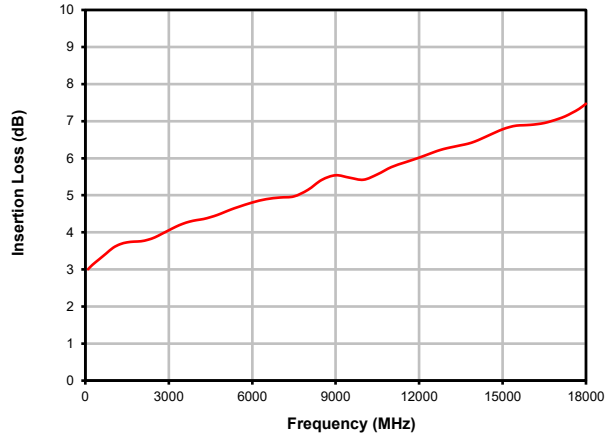

Input VSWR vs. Frequency over Attenuation settings

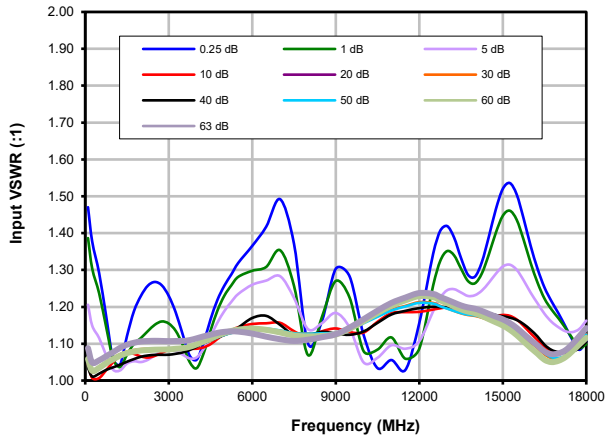

Output VSWR vs. Frequency over Attenuation settings

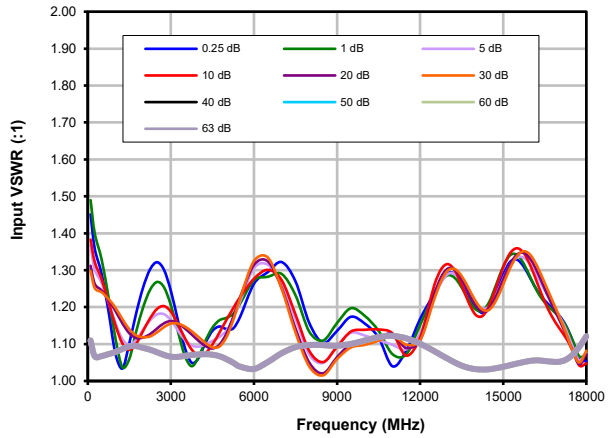

Notes

- A. Performance and quality attributes and conditions not expressly stated in this specification document are intended to be excluded and do not form a part of this specification document.
- B. Electrical specifications and performance data contained in this specification document are based on Mini-Circuit's applicable established test performance criteria and measurement instructions.
- C. The parts covered by this specification document are subject to Mini-Circuits standard limited warranty and terms and conditions (collectively, "Standard Terms"); Purchasers of this part are entitled to the rights and benefits contained therein. For a full statement of the Standard Terms and the exclusive rights and remedies thereunder, please visit Mini-Circuits' website at www.minicircuits.com/MCLStore/terms.jsp



Programmable Attenuator

RCDAT-18G-63

Typical Performance Curves @ 25°C

Attenuation Accuracy
vs. Frequency over Attenuation settings

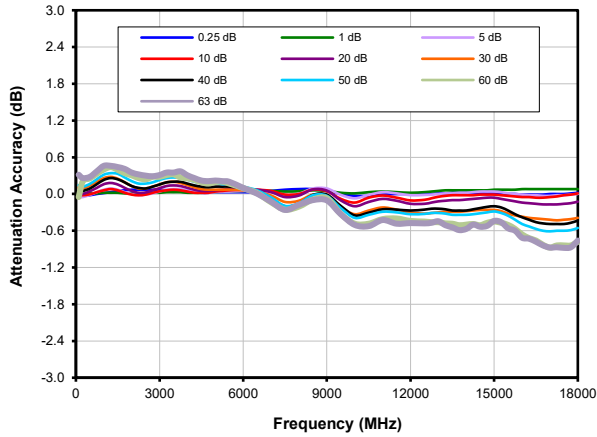

Insertion Loss

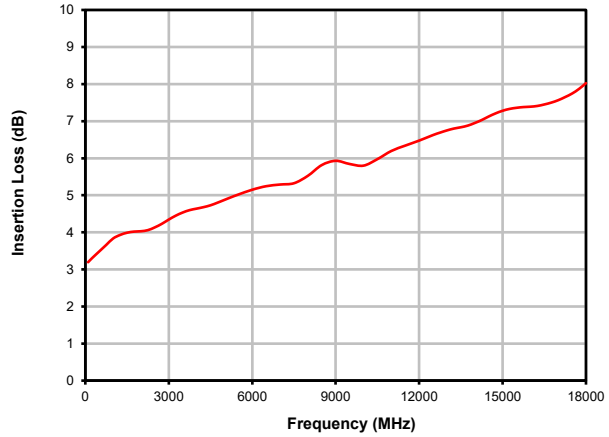

Input VSWR
vs. Frequency over Attenuation settings

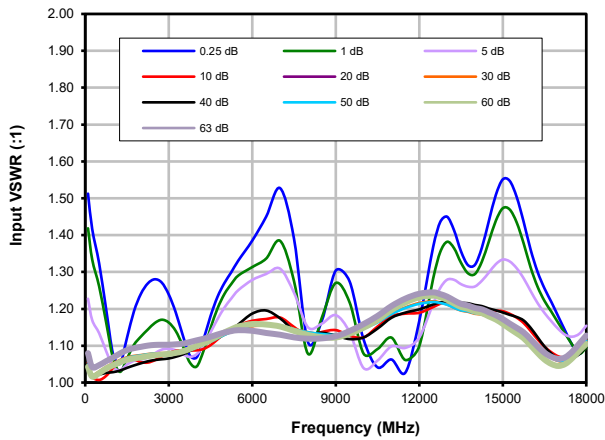

Output VSWR
vs. Frequency over Attenuation settings

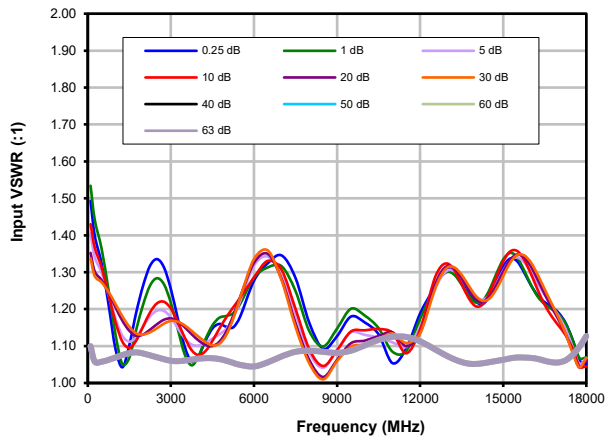

Notes

- A. Performance and quality attributes and conditions not expressly stated in this specification document are intended to be excluded and do not form a part of this specification document.
- B. Electrical specifications and performance data contained in this specification document are based on Mini-Circuit's applicable established test performance criteria and measurement instructions.
- C. The parts covered by this specification document are subject to Mini-Circuits standard limited warranty and terms and conditions (collectively, "Standard Terms"); Purchasers of this part are entitled to the rights and benefits contained therein. For a full statement of the Standard Terms and the exclusive rights and remedies thereunder, please visit Mini-Circuits' website at www.minicircuits.com/MCLStore/terms.jsp



Programmable Attenuator

RCDAT-18G-63

Typical Performance Curves @ 50°C

Attenuation Accuracy
vs. Frequency over Attenuation settings

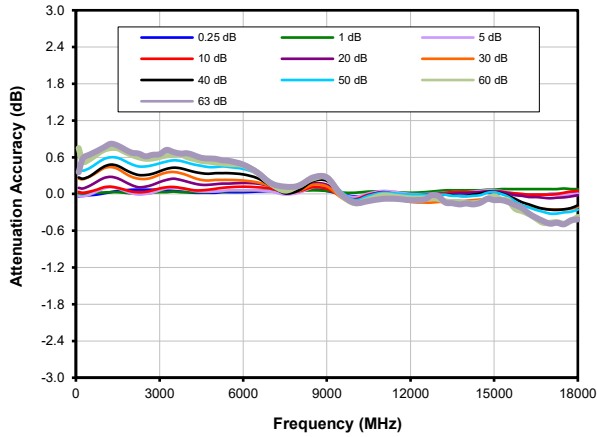

Insertion Loss

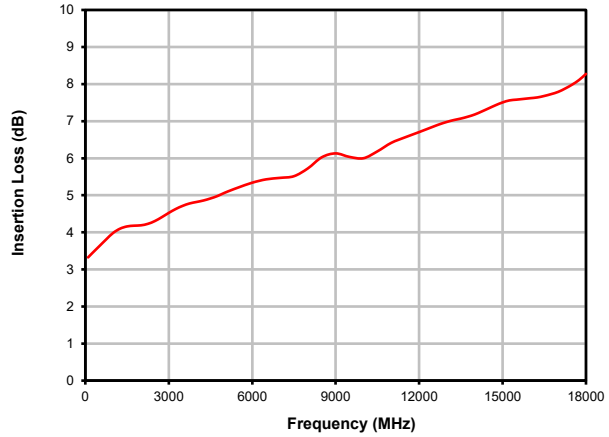

Input VSWR
vs. Frequency over Attenuation settings

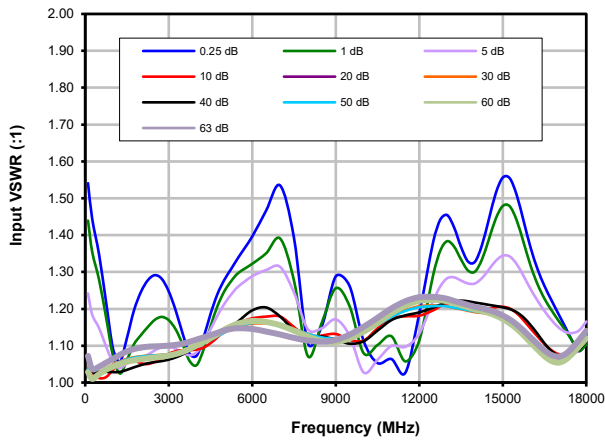

Output VSWR
vs. Frequency over Attenuation settings

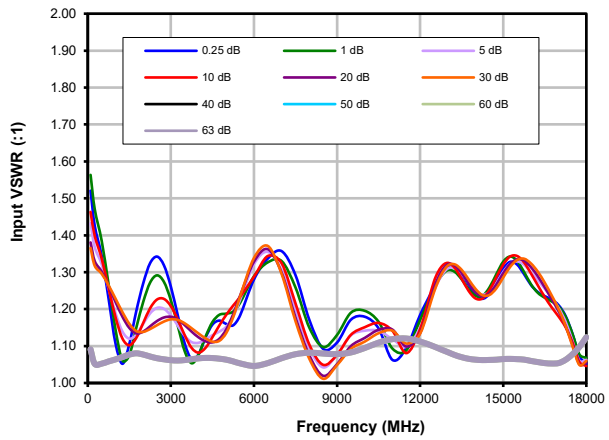

Notes

- A. Performance and quality attributes and conditions not expressly stated in this specification document are intended to be excluded and do not form a part of this specification document.
- B. Electrical specifications and performance data contained in this specification document are based on Mini-Circuit's applicable established test performance criteria and measurement instructions.
- C. The parts covered by this specification document are subject to Mini-Circuits standard limited warranty and terms and conditions (collectively, "Standard Terms"); Purchasers of this part are entitled to the rights and benefits contained therein. For a full statement of the Standard Terms and the exclusive rights and remedies thereunder, please visit Mini-Circuits' website at www.minicircuits.com/MCLStore/terms.jsp



Case Style

QF

Outline Dimensions

QF3189

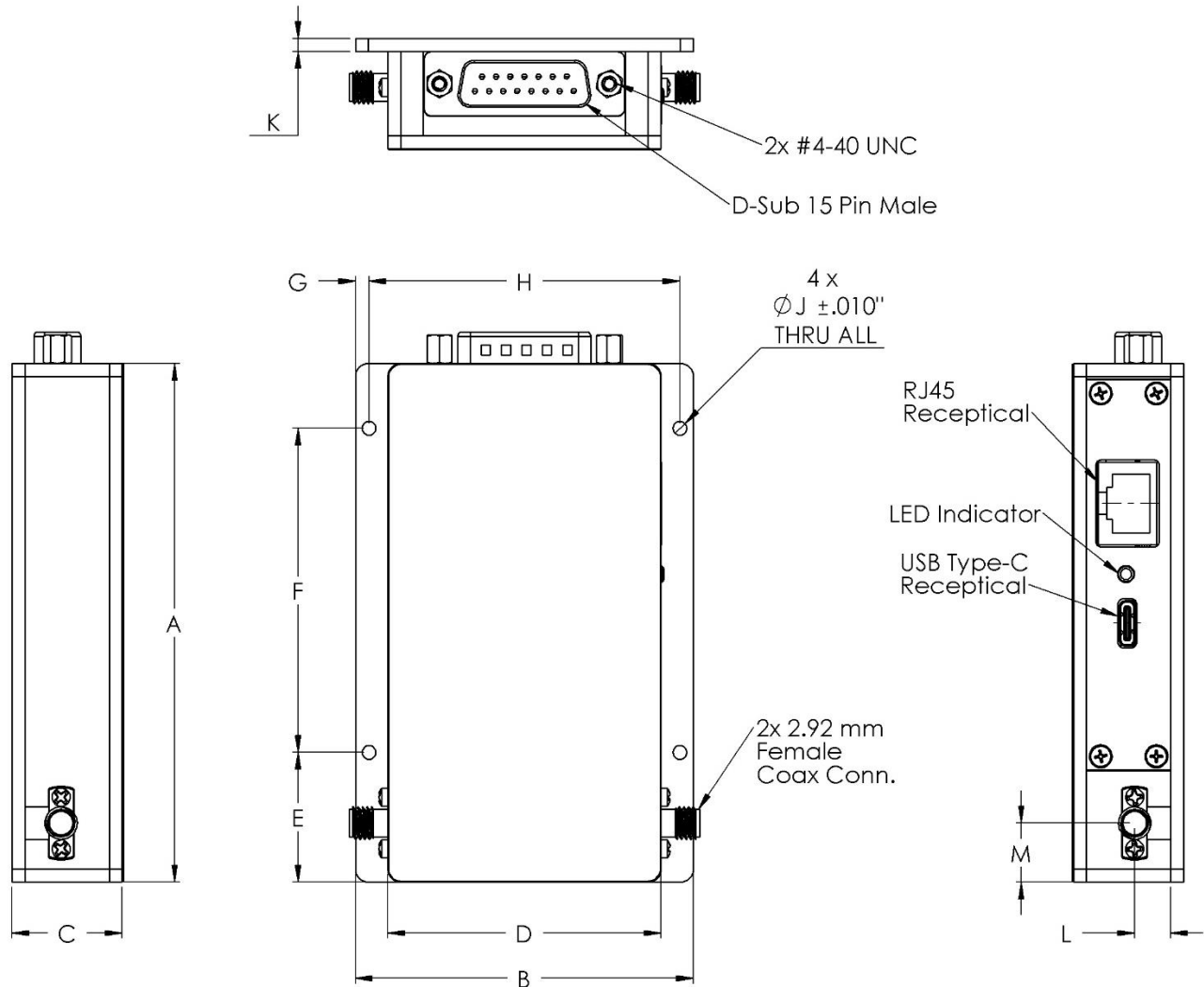

CASE#	A	B	C	D	E	F	G	H	J	K	L	M	WT. GRAMS
QM3189	4.00 (101.60)	2.61 (66.29)	.850 (21.59)	2.11 (53.59)	1.00 (25.40)	2.500 (63.50)	.105 (2.67)	2.400 (60.96)	0.106 (2.69)	0.100 (2.54)	.278 (7.06)	.455 (11.56)	250

Dimensions are in inches (mm). Tolerances: 2PL. +/- .03; 3PL. +/- .015

Notes:

- Case material: Nickel Plated Aluminum.



INTERNET <http://www.minicircuits.com>

P.O. Box 350166, Brooklyn, New York 11235-0003 (718) 934-4500 Fax (718) 332-4661

Distribution Centers NORTH AMERICA 800-654-7949 • 417-335-5935 • Fax 417-335-5945 • EUROPE 44-1252-832600 • Fax 44-1252-837010

Mini-Circuits ISO 9001 & ISO 14001 Certified



Environmental Specifications **ENV55T1**

All Mini-Circuits products are manufactured under exacting quality assurance and control standards, and are capable of meeting published specifications after being subjected to any or all of the following physical and environmental test.

Specification	Test/Inspection Condition	Reference/Spec
Operating Temperature	-0° to 50° C Ambient Environment	Individual Model Data Sheet
Storage Temperature	-20° to 85° C Ambient Environment	Individual Model Data Sheet
Operating and Storage Humidity	5% to 85% RH (non-condensing)	Ambient
Bench Handling Test	Bench Top Tip 45° & Drop	MIL-PRF-28800F
Transit Drop Test	Free Fall Drop, 20 cm (7.9 inches)	MIL-PRF-28800F Class 3