

# Programmable Attenuator

## RC4DAT-8G-120H

50Ω 0 – 120 dB, 0.05 dB step 200 to 8000 MHz

### The Big Deal

- Four independently programmable channels
- Wide attenuation range, 120 dB
- Supports U-NII bands 5-8 (5.925 to 7.125 GHz)
- Fine attenuation resolution, 0.05 dB
- Daisy-chain control of up to 25 attenuators

### Applications

- Wi-Fi 6E MIMO development
- LTE / 5G / IoT / Bluetooth / Zigbee
- Cellular handover testing
- C-band radar / satcom testing
- Automated signal sweeping / fading

### Product Overview

Mini-Circuits' RC4DAT-8G-120H is a 4-channel programmable attenuator suitable for a wide range of signal level control applications from 200 MHz to 8 GHz. Each independently controlled channel provides 0 to 120 dB attenuation in 0.05 dB steps. Its unique design maintains linear attenuation change per dB, even at the highest attenuation settings.

The attenuator can be controlled via USB or Ethernet (supporting SSH, HTTP & Telnet protocols). Full software support is provided, including our user-friendly GUI application for Windows and a full API with programming instructions for Windows and Linux environments (both 32-bit and 64-bit systems). To download the software visit our website at <http://www.minicircuits.com/softwaredownload/patt.html>.

The daisy-chain control interface with Mini-Circuit's novel dynamic addressing feature simplifies control systems, allowing multiple attenuators to be connected into a Master / Slave chain. Simply connect, then power on and the whole chain of up to 25 RC4DAT-8G-120H attenuators (with up to 100 channels) can be independently controlled through a single USB or Ethernet connection, with a single software interface.

### Key Features

Feature	Advantages
USB & Ethernet control	USB HID and Ethernet (HTTP / Telnet / SSH) interfaces provide easy compatibility with a wide range of software setups and programming environments. The device draws all power requirements through the USB port.
Programmable attenuation sweep and Hop sequences	The RC4DAT-8G-120H can be programmed with a timed sequence of attenuation settings, to run without any additional external control.
120 dB attenuation range.	The RC4DAT-8G-120H provides high-accuracy attenuation up to 120 dB in 0.05 dB steps, allowing the user precise level control over a broad attenuation and frequency range.
High linearity	Typical input IP3 of +51 dBm up to 8000 MHz.

**Trademarks:** Windows is a registered trademark of Microsoft Corporation in the United States and other countries. Linux is a registered trademark of Linus Torvalds. Mac is a registered trademark of Apple Corporation. Pentium is a registered trademark of Intel Corporation. Neither Mini-Circuits nor the Mini-Circuits RC4DAT-series attenuators are affiliated with or endorsed by the owners of the above referenced trademarks.

Mini-Circuits and the Mini-Circuits logo are registered trademarks of Scientific Components Corporation.



Software Package

Case Style: QE2671

#### Included Accessories

Model No.	Description	Qty.
MUSB-CBL-3+	3.3 ft. USB cable	1

#### RoHS Compliant

See our web site for RoHS Compliance methodologies and qualifications

## Electrical Specifications <sup>1,2</sup> at +25°C

Parameter	Frequency range	Conditions	Min.	Typ.	Max.	Units
Attenuation range	200 - 8000 MHz	0.05 dB step	0	-	105	dB
		0.10 dB step	105		120	
Attenuation accuracy <sup>2</sup>	200 - 8000 MHz	@ 0.05 - 30 dB	-	±0.50	±(0.8+4.0% of nominal value)	dB
		@ 30.05 - 60 dB	-	±1.20	±(1.4+2.0% of nominal value)	
		@ 60.05 - 90 dB	-	±2.10	±(0.2+4.0% of nominal value)	
		@ 90.05 - 110 dB	-	±3.20	±(-3.4+8.0% of nominal value)	
		@ 110.10 - 120 dB	-	±4.30	±7.0	
Insertion Loss	200 - 2000 MHz	@ 0 dB	-	5.7	7.0	dB
	2000 - 4000 MHz		-	7.2	9.0	
	4000 - 6000 MHz		-	9.5	11.5	
	6000 - 7200 MHz		-	12	14	
	7200 - 8000 MHz		-	13	14.5	
Isolation In-Out	200 - 8000 MHz	Note 3	-	130	-	dB
Isolation (between channels)	200 - 6000 MHz	@ 0 - 120 dB	127	140	-	dB
	6000 - 7200 MHz		125	137	-	
	7200 - 8000 MHz		115	130	-	
Input operating power <sup>4</sup> (RF In and RF Out ports)	200 - 8000 MHz	@ 0 - 120 dB	-	-	+23	dBm
IP3 Input <sup>5</sup>	200 - 8000 MHz	@ 0 dB setting (P <sub>IN</sub> =+5 dBm)	-	+50	-	dBm
VSWR	200 - 8000 MHz	@ 0 - 15 dB	-	1.35	-	:1
		@ 15.05 - 120 dB	-	1.20	-	
Min Dwell Time <sup>3,6</sup>	200 - 8000 MHz	High speed mode	-	600	-	µsec
Channel Synchronization	200 - 8000 MHz	Note 7	-	400	-	µsec
Attenuation Transition Time <sup>8</sup>	200 - 8000 MHz	to ±0.25 dB of final value	-	1	-	nSec
Supply Voltage	-	via USB port	4.75	5	5.25	V
USB current draw (single unit)	Ethernet Enabled	-	-	250	350	mA
	Ethernet Disabled	-	-	230	280	
DC current pass through	-	-	-	-	1000	
Ethernet Communication	Protocol	TCP / IP, HTTP, Telnet, SSH, DHCP, UDP (limited)				
	Max Data Rate	100 Mbps (100 Base-T Full Duplex)				
USB Communication	Protocol	HID (Human Interface Device) - High Speed				
	Min Communication Time <sup>9</sup>	400 µs Typ (full transmit/receive cycle)				

<sup>1</sup> Attenuator RF ports are interchangeable, and support simultaneous, bidirectional signal transmission, however the specifications are guaranteed for the RF in and RF out as noted on the label. There may be minor changes in performance when injecting signals to the RF Out port.

<sup>2</sup> Max setting accuracy defined as ±[absolute error+% of attenuation setting]. For example, when setting the attenuator to 108 dB attenuation the maximum error at 7500 MHz will be: ±(-5+0.09x108)= ±(-5+9.72)= ± 4.72 dB

<sup>3</sup> Isolation is defined as max attenuation plus insertion loss; this is the path loss through the attenuator when initially powered up. After a brief delay (-0.5 sec typically) the attenuator will revert to a user defined "power-up" state (either max attenuation or a pre-set value).

<sup>4</sup> Total operating input power from both RF In and RF Out out ports. Compression level not noted as it exceeds max safe operating power level.

<sup>5</sup> IP3 tested with 1 MHz span between signals.

<sup>6</sup> Minimum Dwell Time is the time the RC4DAT will take to respond to a command to change attenuation states of a single channel without communication delays.

<sup>7</sup> Channel Synchronization is the delay between the first and last attenuator transitions beginning, in response to a command to set all channels.

<sup>8</sup> Attenuation Transition Time is specified as the time between starting to change the attenuation state and settling on the requested attenuation state.

<sup>9</sup> USB min communication time is based on the polling interval of the USB HID protocol(125 µs polling interval, 1024 bytes per packet), medium CPU load and no other high speed USB devices using the USB bus.

## Absolute Maximum Ratings

Operating Temperature	0°C to 50°C
Storage Temperature	-20°C to 85°C
V <sub>USB</sub> Max.	6V
DC voltage at RF port	25V
Total RF power for RF In & RF Out	+26 dBm

Permanent damage may occur if any of these limits are exceeded. Operating in the range between operating power limits and absolute maximum ratings for extended periods of time may result in reduced life and reliability.

## Connections

RF In 1,2,3,4	(SMA female)
RF Out 1,2,3,4	(SMA female)
USB	(USB type Mini-B female)
Network (Ethernet/LAN)	(RJ45 socket)
Serial Control Out	(10 Pin Digital Snap Fit female) <sup>11</sup>
Serial Control In	(10 Pin Digital Snap Fit female) <sup>11</sup>

<sup>11</sup> Mating connector is Hirose ST40X-10S-CV(30)

## Block Diagram

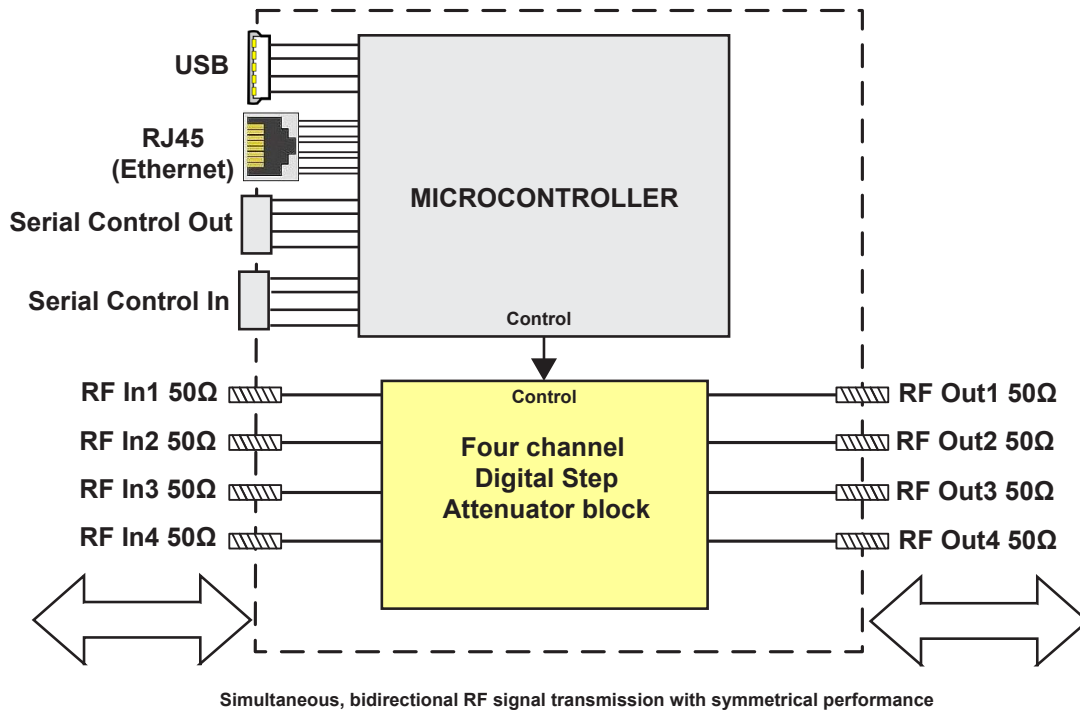

## RC4DAT response to communication interrupt

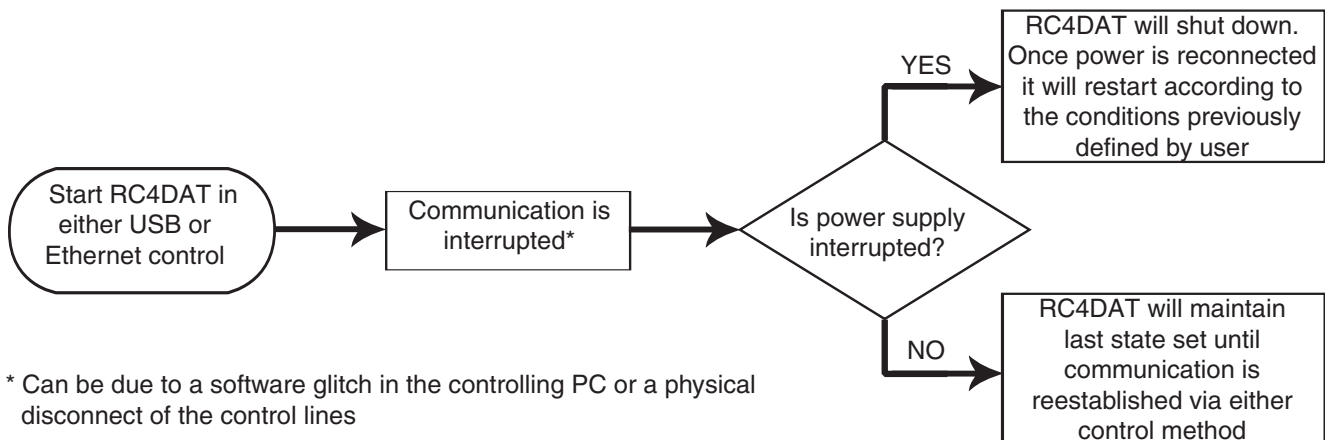

\* Can be due to a software glitch in the controlling PC or a physical disconnect of the control lines

## Outline Drawing (QE2671)

## Connections

RF In 1,2,3,4	(SMA female)
RF Out 1,2,3,4	(SMA female)
USB	(USB type Mini-B female)
Network (Ethernet/LAN)	(RJ45 socket)
Serial Control Out	(10 Pin Digital Snap Fit female)
Serial Control In	(10 Pin Digital Snap Fit female)

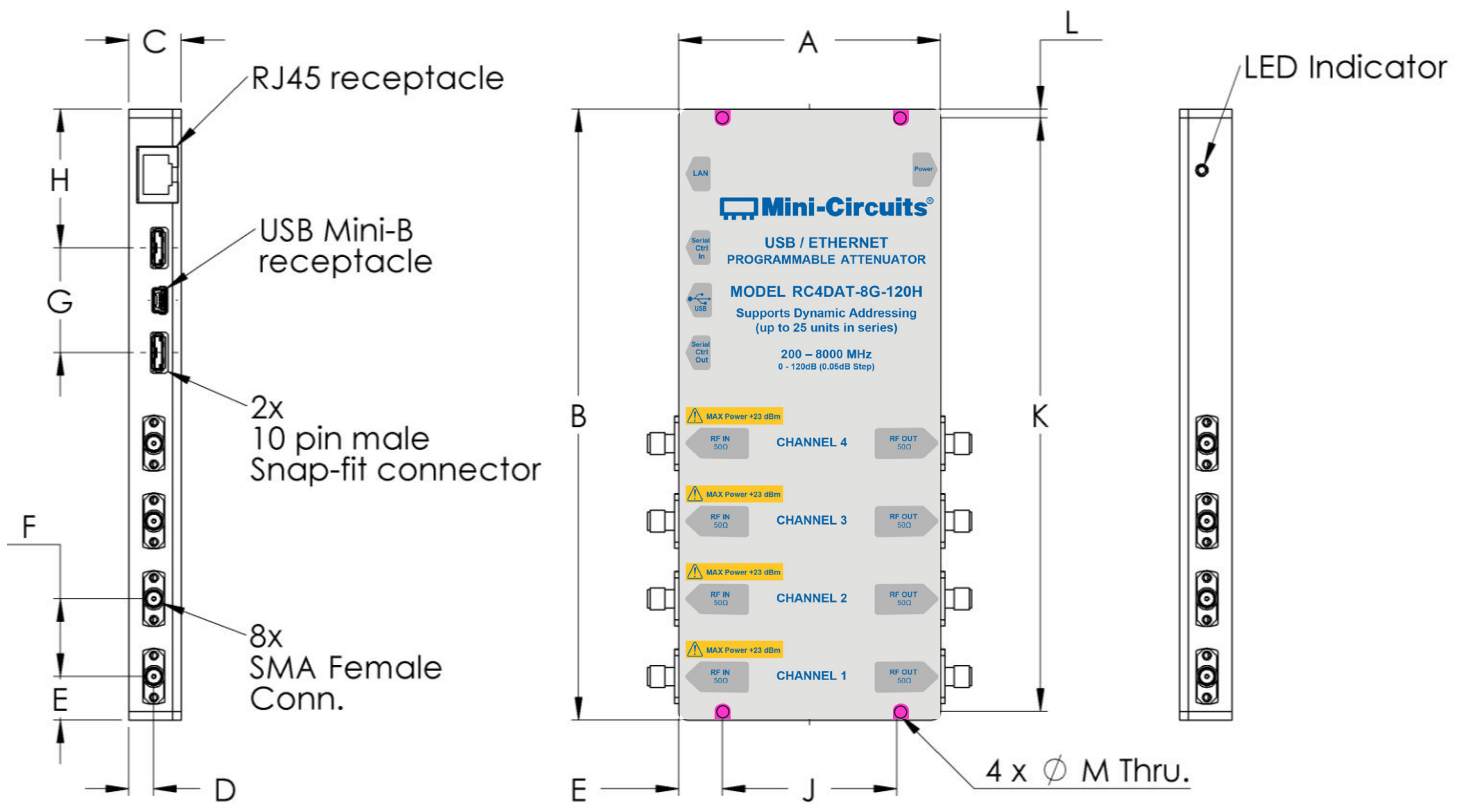

## Outline Dimensions ( $\frac{\text{inch}}{\text{mm}}$ )

A	B	C	D	E	F	G	H	J	K	L	M	WT. GRAMS
3.00	7.00	0.60	0.287	0.50	0.890	1.20	1.59	2.00	6.800	0.10	0.125	500
76.2	177.8	15.24	7.29	12.7	22.61	30.5	40.4	50.80	172.72	2.54	3.18	

## Typical Performance Data @ +25°C

FREQ. (MHz)	I. Loss (dB)	Attenuation relative to I. Loss (dB)									
		@ Attenuation setting (dB)									
		1	5	10	20	40	60	80	100	110	120
200	4.20	1.05	5.16	10.15	20.43	40.84	60.94	81.33	101.33	110.24	118.94
400	4.48	1.03	5.06	10.03	20.34	40.55	60.66	80.61	99.90	108.77	117.58
600	4.82	1.00	4.95	9.89	20.20	40.31	60.46	80.31	99.69	108.65	117.56
800	5.12	0.97	4.86	9.80	20.10	40.18	60.36	80.33	99.96	109.10	118.19
1000	5.33	0.97	4.84	9.81	20.09	40.17	60.39	80.46	100.29	109.56	118.78
1200	5.48	0.98	4.88	9.89	20.15	40.25	60.48	80.64	100.59	109.95	119.09
1400	5.69	0.99	4.93	9.98	20.23	40.35	60.62	80.84	100.89	110.30	119.45
1600	5.89	1.00	4.96	10.01	20.25	40.39	60.68	80.95	101.01	110.47	119.72
1800	5.98	0.99	4.95	10.00	20.22	40.38	60.69	80.93	101.12	110.64	120.14
2000	6.13	0.98	4.94	9.99	20.18	40.36	60.69	81.00	101.27	110.70	120.55
2400	6.45	0.99	4.99	10.08	20.22	40.46	60.84	81.19	101.52	111.10	120.67
2800	6.70	1.02	5.09	10.22	20.37	40.67	61.02	81.56	101.96	111.64	121.52
3200	7.00	1.03	5.13	10.22	20.44	40.82	61.18	81.76	102.24	112.20	121.97
3600	7.41	1.03	5.12	10.13	20.45	40.90	61.25	81.88	102.61	112.63	122.47
4000	7.78	1.04	5.18	10.13	20.51	41.05	61.32	82.14	102.97	113.15	123.41
4400	8.16	1.04	5.26	10.17	20.60	41.20	61.42	82.21	103.17	113.54	123.56
4800	8.67	1.01	5.25	10.11	20.58	41.21	61.37	82.34	103.32	113.82	124.13
5000	8.95	1.00	5.22	10.06	20.58	41.20	61.29	82.20	103.34	113.58	123.89
5400	9.34	1.00	5.25	10.10	20.72	41.33	61.43	82.42	103.48	114.25	124.17
5600	9.52	1.02	5.28	10.15	20.83	41.42	61.46	82.55	103.57	114.00	124.90
6000	10.01	1.02	5.28	10.20	20.91	41.45	61.64	82.66	103.60	114.08	124.42
6200	10.39	1.01	5.24	10.19	20.83	41.34	61.56	82.55	103.30	114.11	124.59
6400	10.87	0.99	5.17	10.15	20.67	41.13	61.39	82.43	103.10	113.63	123.85
6500	11.13	0.97	5.13	10.12	20.58	40.99	61.29	82.24	102.86	113.52	124.16
6700	11.67	0.95	5.06	10.07	20.38	40.70	61.02	81.89	102.35	113.24	123.55
6800	11.92	0.95	5.04	10.07	20.30	40.57	60.93	81.74	102.21	112.80	123.27
7000	12.35	0.96	5.06	10.11	20.22	40.37	60.75	81.57	101.85	112.57	123.76
7100	12.50	0.97	5.09	10.16	20.24	40.32	60.68	81.42	101.62	112.32	123.05
7300	12.71	1.01	5.20	10.30	20.34	40.27	60.67	81.27	101.39	112.06	121.95
7400	12.80	1.03	5.25	10.37	20.42	40.26	60.57	81.22	101.27	111.86	122.53
7600	12.96	1.05	5.31	10.44	20.53	40.21	60.50	80.86	100.85	111.22	121.58
7700	13.07	1.05	5.31	10.44	20.56	40.15	60.42	80.59	100.57	111.04	121.64
7900	13.31	1.04	5.26	10.38	20.56	39.95	60.12	80.10	99.98	110.39	119.93
8000	13.44	1.03	5.23	10.33	20.54	39.83	59.94	79.84	99.61	109.88	119.37

FREQ. (MHz)	I. Loss (dB)	Attenuation relative to I. Loss														
		Fine resolution (0.05 dB)														
		@ Attenuation setting (dB)														
		7.40	7.45	7.50	7.55	7.60	67.40	67.45	67.50	67.55	67.60	100.40	100.45	100.50	100.55	100.60
200	4.20	7.52	7.59	7.63	7.68	7.70	68.55	68.60	68.66	68.71	68.75	99.06	99.13	99.21	99.23	99.27
400	4.48	7.41	7.45	7.55	7.58	7.64	67.85	67.89	67.96	68.01	68.05	97.66	97.72	97.79	97.82	97.89
600	4.82	7.33	7.31	7.41	7.48	7.50	67.62	67.67	67.73	67.78	67.83	97.72	97.76	97.84	97.88	97.92
800	5.12	7.22	7.25	7.33	7.35	7.42	67.66	67.70	67.75	67.80	67.85	98.22	98.31	98.35	98.43	98.44
1000	5.33	7.25	7.28	7.33	7.37	7.42	67.83	67.88	67.92	67.98	68.03	98.78	98.83	98.89	98.98	98.97
1200	5.48	7.28	7.36	7.40	7.43	7.51	67.97	68.02	68.06	68.11	68.16	99.18	99.17	99.26	99.31	99.35
1400	5.69	7.39	7.45	7.48	7.56	7.62	68.20	68.25	68.28	68.33	68.39	99.58	99.62	99.61	99.71	99.75
1600	5.89	7.42	7.44	7.45	7.58	7.62	68.27	68.32	68.35	68.40	68.46	99.78	99.85	99.88	99.87	100.03
1800	5.98	7.44	7.47	7.50	7.54	7.54	68.23	68.28	68.31	68.36	68.42	99.96	99.97	99.99	100.10	100.08
2000	6.13	7.38	7.46	7.48	7.55	7.52	68.24	68.29	68.32	68.37	68.43	100.15	100.14	100.14	100.23	100.31
2400	6.45	7.50	7.55	7.55	7.62	7.66	68.36	68.41	68.43	68.48	68.54	100.47	100.56	100.46	100.57	100.66
2800	6.70	7.58	7.64	7.62	7.69	7.75	68.65	68.71	68.72	68.78	68.83	101.03	101.05	101.15	101.19	101.23
3200	7.00	7.52	7.57	7.60	7.69	7.73	68.73	68.78	68.78	68.84	68.91	101.61	101.69	101.73	101.74	101.85
3600	7.41	7.33	7.41	7.46	7.50	7.60	68.76	68.82	68.81	68.88	68.94	102.00	102.13	102.11	102.19	102.25
4000	7.78	7.32	7.38	7.40	7.49	7.49	68.83	68.89	68.87	68.94	69.01	102.48	102.51	102.47	102.58	102.61
4400	8.16	7.34	7.46	7.47	7.49	7.56	68.87	68.94	68.91	68.98	69.05	102.80	102.83	102.78	102.91	102.97
4800	8.67	7.33	7.44	7.37	7.47	7.52	68.77	68.84	68.81	68.88	68.95	103.06	103.04	103.01	103.05	103.18
5000	8.95	7.30	7.33	7.31	7.31	7.45	68.72	68.79	68.75	68.82	68.90	103.04	103.12	103.00	103.04	103.22
5400	9.34	7.32	7.33	7.35	7.39	7.45	68.72	68.79	68.74	68.82	68.90	103.16	103.16	103.17	103.33	103.28
5600	9.52	7.33	7.47	7.36	7.43	7.46	68.83	68.91	68.86	68.94	69.02	103.51	103.44	103.24	103.36	103.59
6000	10.01	7.44	7.50	7.41	7.49	7.51	68.93	69.00	68.97	69.04	69.12	103.37	103.58	103.37	103.60	103.74
6200	10.39	7.46	7.60	7.38	7.52	7.60	68.87	68.94	68.91	68.99	69.07	103.48	103.55	103.55	103.39	103.58
6400	10.87	7.47	7.51	7.42	7.50	7.63	68.64	68.72	68.71	68.78	68.85	103.23	103.28	103.39	103.22	103.28
6500	11.13	7.55	7.51	7.50	7.55	7.68	68.47	68.54	68.54	68.61	68.68	102.92	103.03	102.96	103.12	103.20
6700	11.67	7.44	7.50	7.44	7.50	7.57	68.10	68.16	68.17	68.24	68.31	102.39	102.54	102.67	102.63	102.66
6800	11.92	7.43	7.47	7.39	7.42	7.49	67.97	68.04	68.05	68.12	68.19	102.35	102.46	102.45	102.41	102.49
7000	12.35	7.51	7.47	7.41	7.53	7.56	67.78	67.84	67.87	67.94	68.01	102.04	102.02	101.96	102.20	102.28
7100	12.50	7.54	7.61	7.47	7.54	7.67	67.71	67.77	67.81	67.87	67.93	101.91	101.88	101.89	102.07	102.00
7300	12.71	7.62	7.73	7.63	7.77	7.82	67.64	67.70	67.75	67.81	67.87	101.56	101.51	101.65	101.70	101.94
7400	12.80	7.75	7.69	7.68	7.73	7.78	67.64	67.69	67.74	67.80	67.87	101.56	101.64	101.52	101.53	101.75
7600	12.96	7.80	7.92	7.66	7.80	7.83	67.48	67.53	67.60	67.65	67.72	101.02	101.08	101.00	101.11	101.21
7700	13.07	7.72	7.84	7.51	7.82	7.75	67.31	67.37	67.43	67.49	67.55	100.63	100.80	100.82	100.83	100.81
7900	13.31	7.60	7.75	7.57	7.71	7.81	66.92	66.98	67.04	67.10	67.16	100.04	100.17	100.15	100.20	100.11
8000	13.44	7.53	7.65	7.51	7.62	7.69	66.75	66.81	66.87	66.93	67.00	99.65	99.84	99.86	99.77	99.76



### Typical Performance Data @ 0°C

FREQ. (MHz)	I. Loss (dB)	Attenuation relative to I. Loss (dB)									
		@ Attenuation setting (dB)									
		1	5	10	20	40	60	80	100	110	120
200	4.17	1.05	5.19	10.15	20.48	40.90	61.01	81.42	101.39	110.31	119.25
400	4.43	1.03	5.10	10.04	20.40	40.62	60.75	80.69	100.04	108.90	117.72
600	4.76	0.99	4.97	9.89	20.26	40.38	60.52	80.45	99.88	108.87	117.73
800	5.05	0.97	4.88	9.81	20.15	40.25	60.45	80.47	100.15	109.35	118.29
1000	5.26	0.96	4.85	9.81	20.13	40.23	60.47	80.58	100.49	109.68	118.87
1200	5.39	0.97	4.88	9.89	20.18	40.30	60.58	80.75	100.75	110.10	119.43
1400	5.60	0.99	4.93	9.97	20.26	40.39	60.70	80.96	101.00	110.44	119.65
1600	5.81	0.99	4.95	10.00	20.28	40.43	60.77	81.02	101.13	110.72	119.87
1800	5.89	0.99	4.95	9.99	20.26	40.41	60.77	81.06	101.24	110.74	120.09
2000	6.04	0.98	4.94	9.98	20.23	40.40	60.81	81.09	101.30	110.88	120.32
2400	6.35	0.99	5.00	10.07	20.28	40.50	60.88	81.27	101.61	111.30	120.64
2800	6.62	1.02	5.12	10.21	20.43	40.72	61.11	81.60	101.98	111.78	121.46
3200	6.90	1.04	5.16	10.23	20.50	40.88	61.26	81.85	102.43	112.39	122.13
3600	7.30	1.04	5.15	10.15	20.51	40.97	61.36	82.01	102.66	112.88	122.47
4000	7.66	1.05	5.20	10.14	20.57	41.12	61.45	82.21	103.03	113.14	123.36
4400	8.03	1.05	5.29	10.19	20.67	41.26	61.51	82.38	103.33	113.67	123.80
4800	8.53	1.02	5.28	10.12	20.66	41.26	61.42	82.27	103.31	113.81	124.57
5000	8.80	1.00	5.26	10.08	20.66	41.24	61.37	82.31	103.36	113.77	124.61
5400	9.19	1.00	5.30	10.11	20.81	41.34	61.51	82.39	103.49	113.96	124.63
5600	9.37	1.01	5.32	10.16	20.91	41.41	61.60	82.62	103.56	114.37	125.45
6000	9.84	1.03	5.33	10.24	21.00	41.43	61.65	82.71	103.51	114.37	125.10
6200	10.20	1.01	5.29	10.23	20.93	41.32	61.63	82.67	103.48	114.09	125.39
6400	10.67	0.99	5.22	10.19	20.77	41.10	61.46	82.46	103.06	113.92	124.48
6500	10.94	0.98	5.18	10.16	20.67	40.95	61.34	82.28	103.00	113.65	123.76
6700	11.48	0.95	5.10	10.11	20.45	40.64	61.03	81.98	102.43	113.19	124.08
6800	11.74	0.95	5.08	10.09	20.36	40.49	60.92	81.80	102.24	112.96	123.30
7000	12.17	0.95	5.09	10.13	20.26	40.27	60.75	81.42	101.79	112.54	122.50
7100	12.32	0.96	5.12	10.18	20.27	40.21	60.65	81.37	101.72	112.34	123.07
7300	12.53	1.00	5.22	10.32	20.38	40.16	60.65	81.17	101.44	111.88	122.75
7400	12.60	1.02	5.28	10.39	20.45	40.15	60.60	81.11	101.29	111.76	122.32
7600	12.75	1.04	5.34	10.47	20.57	40.10	60.49	80.79	100.88	111.35	122.65
7700	12.85	1.05	5.34	10.47	20.60	40.04	60.41	80.59	100.56	111.22	121.03
7900	13.09	1.04	5.29	10.39	20.59	39.83	60.10	80.16	100.13	110.39	120.53
8000	13.22	1.03	5.25	10.34	20.57	39.71	59.94	79.84	99.80	109.92	119.77

FREQ. (MHz)	I. Loss (dB)	Attenuation relative to I. Loss Fine resolution (0.05 dB)														
		@ Attenuation setting (dB)														
		7.40	7.45	7.50	7.55	7.60	67.40	67.45	67.50	67.55	67.60	100.40	100.45	100.50	100.55	100.60
200	4.17	7.55	7.60	7.64	7.69	7.75	68.67	68.72	68.77	68.82	68.87	99.23	99.27	99.36	99.40	99.42
400	4.43	7.45	7.50	7.54	7.59	7.65	67.99	68.03	68.09	68.14	68.19	97.82	97.86	97.95	97.98	98.01
600	4.76	7.33	7.38	7.41	7.47	7.53	67.76	67.81	67.86	67.91	67.96	97.89	97.93	97.97	98.05	98.06
800	5.05	7.26	7.31	7.34	7.40	7.45	67.78	67.83	67.87	67.93	67.98	98.39	98.49	98.52	98.55	98.61
1000	5.26	7.27	7.32	7.35	7.41	7.47	67.95	68.00	68.03	68.09	68.14	98.94	98.96	99.04	99.11	99.15
1200	5.39	7.34	7.38	7.42	7.48	7.53	68.09	68.14	68.17	68.23	68.28	99.34	99.38	99.41	99.46	99.51
1400	5.60	7.41	7.46	7.49	7.54	7.60	68.32	68.37	68.39	68.45	68.51	99.71	99.78	99.81	99.87	99.95
1600	5.81	7.43	7.48	7.50	7.56	7.62	68.40	68.45	68.47	68.52	68.58	99.92	100.03	100.02	100.14	100.09
1800	5.89	7.41	7.47	7.48	7.54	7.60	68.36	68.41	68.43	68.49	68.54	100.09	100.13	100.15	100.20	100.29
2000	6.04	7.41	7.46	7.46	7.52	7.58	68.38	68.43	68.44	68.50	68.56	100.24	100.32	100.31	100.38	100.42
2400	6.35	7.49	7.55	7.53	7.60	7.66	68.49	68.55	68.55	68.61	68.67	100.64	100.77	100.76	100.82	100.82
2800	6.62	7.62	7.67	7.66	7.73	7.79	68.79	68.85	68.84	68.90	68.97	101.21	101.25	101.24	101.25	101.37
3200	6.90	7.57	7.62	7.63	7.69	7.75	68.88	68.94	68.93	68.99	69.06	101.78	101.86	101.87	101.94	101.99
3600	7.30	7.44	7.50	7.51	7.57	7.63	68.94	69.00	68.97	69.04	69.11	102.32	102.41	102.30	102.37	102.48
4000	7.66	7.41	7.47	7.47	7.54	7.60	68.99	69.06	69.02	69.09	69.17	102.64	102.71	102.67	102.76	102.82
4400	8.03	7.46	7.52	7.50	7.57	7.64	69.04	69.11	69.06	69.14	69.21	103.06	103.07	103.05	103.14	103.23
4800	8.53	7.40	7.47	7.42	7.50	7.58	68.94	69.02	68.96	69.04	69.12	103.42	103.39	103.22	103.36	103.42
5000	8.80	7.35	7.42	7.36	7.44	7.52	68.89	68.96	68.90	68.99	69.07	103.32	103.42	103.28	103.34	103.48
5400	9.19	7.34	7.42	7.34	7.42	7.50	68.89	68.97	68.90	68.99	69.07	103.48	103.48	103.34	103.44	103.46
5600	9.37	7.39	7.47	7.37	7.46	7.54	68.99	68.97	69.00	69.09	69.17	103.53	103.69	103.49	103.59	103.70
6000	9.84	7.49	7.58	7.45	7.54	7.63	69.11	69.18	69.13	69.21	69.30	103.87	103.85	103.81	104.04	103.89
6200	10.20	7.52	7.61	7.47	7.56	7.65	69.07	69.15	69.10	69.19	69.27	103.74	103.83	103.82	103.85	103.85
6400	10.67	7.52	7.61	7.47	7.56	7.65	68.87	68.95	68.92	69.00	69.08	103.47	103.78	103.52	103.58	103.59
6500	10.94	7.51	7.60	7.46	7.55	7.64	68.71	68.78	68.76	68.83	68.91	103.28	103.42	103.40	103.37	103.54
6700	11.48	7.49	7.57	7.44	7.52	7.61	68.33	68.40	68.39	68.47	68.54	102.81	103.00	102.96	103.04	103.04
6800	11.74	7.48	7.56	7.43	7.52	7.60	68.18	68.24	68.24	68.32	68.39	102.70	102.79	102.83	102.92	102.94
7000	12.17	7.52	7.59	7.48	7.56	7.63	67.98	68.04	68.05	68.12	68.19	102.51	102.29	102.27	102.32	102.43
7100	12.32	7.56	7.63	7.52	7.60	7.67	67.89	67.95	67.97	68.04	68.11	102.33	102.32	102.18	102.23	102.25
7300	12.53	7.68	7.74	7.65	7.72	7.79	67.83	67.89	67.92	67.99	68.05	101.91	101.75	101.91	102.06	102.11
7400	12.60	7.73	7.79	7.70	7.77	7.83	67.84	67.90	67.93	68.00	68.06	101.69	101.67	101.77	101.78	101.92
7600	12.75	7.77	7.83	7.74	7.81	7.88	67.68	67.74	67.79	67.85	67.91	101.45	101.30	101.36	101.48	101.50
7700	12.85	7.76	7.82	7.73	7.80	7.86	67.51	67.57	67.62	67.68	67.75	101.17	101.14	101.11	101.11	101.28
7900	13.09	7.68	7.74	7.65	7.72	7.79	67.13	67.19	67.24	67.30	67.37	100.30	100.52	100.31	100.52	100.54
8000	13.22	7.63	7.69	7.60	7.67	7.73	66.97	67.03	67.08	67.15	67.21	100.07	100.20	100.10	100.21	100.27





## Typical Performance Data @ +50°C

FREQ. (MHz)	I. Loss (dB)	Attenuation relative to I. Loss (dB)									
		@ Attenuation setting (dB)									
		1	5	10	20	40	60	80	100	110	120
200	4.28	1.03	5.11	10.12	20.34	40.72	60.80	81.09	100.96	109.86	118.75
400	4.59	1.01	5.01	9.98	20.24	40.41	60.48	80.35	99.60	108.44	117.28
600	4.94	0.98	4.90	9.84	20.11	40.17	60.24	80.07	99.36	108.35	117.05
800	5.24	0.96	4.82	9.76	20.02	40.05	60.15	80.11	99.66	108.87	117.86
1000	5.47	0.96	4.82	9.78	20.02	40.06	60.21	80.21	99.96	109.14	118.21
1200	5.62	0.97	4.87	9.87	20.09	40.15	60.29	80.39	100.31	109.57	118.73
1400	5.84	0.99	4.92	9.96	20.16	40.25	60.45	80.61	100.57	109.95	119.20
1600	6.02	0.99	4.95	9.99	20.18	40.29	60.53	80.67	100.73	110.01	119.35
1800	6.12	0.98	4.93	9.99	20.15	40.29	60.52	80.73	100.81	110.27	119.60
2000	6.29	0.97	4.92	9.98	20.10	40.27	60.53	80.77	100.89	110.44	119.77
2400	6.60	0.98	4.95	10.06	20.14	40.37	60.68	81.00	101.25	110.69	120.47
2800	6.85	1.01	5.05	10.19	20.28	40.57	60.88	81.35	101.59	111.29	120.73
3200	7.16	1.02	5.09	10.18	20.35	40.70	61.00	81.47	101.91	111.79	121.49
3600	7.59	1.02	5.09	10.09	20.36	40.78	61.08	81.65	102.28	112.25	122.41
4000	7.97	1.03	5.15	10.09	20.43	40.93	61.18	81.83	102.59	112.68	122.87
4400	8.35	1.03	5.24	10.14	20.51	41.10	61.24	82.03	102.90	113.07	123.60
4800	8.90	0.99	5.21	10.07	20.48	41.12	61.22	82.13	103.09	113.23	123.80
5000	9.17	0.98	5.18	10.02	20.47	41.12	61.18	82.12	103.14	113.26	123.80
5400	9.58	0.99	5.21	10.05	20.62	41.28	61.30	82.24	103.29	113.71	124.77
5600	9.76	1.01	5.24	10.10	20.72	41.38	61.43	82.41	103.40	113.77	125.00
6000	10.26	1.01	5.24	10.16	20.80	41.43	61.54	82.62	103.42	113.93	124.66
6200	10.65	1.00	5.19	10.15	20.72	41.33	61.52	82.58	103.30	113.78	124.60
6400	11.14	0.98	5.12	10.10	20.57	41.13	61.36	82.32	102.94	113.28	124.28
6500	11.41	0.96	5.08	10.07	20.47	41.00	61.22	82.19	102.68	113.24	124.29
6700	11.95	0.94	5.01	10.03	20.27	40.73	61.01	81.89	102.40	112.90	123.97
6800	12.20	0.94	5.00	10.02	20.20	40.60	60.89	81.61	101.99	112.72	124.02
7000	12.61	0.95	5.03	10.07	20.15	40.44	60.68	81.40	101.66	112.20	122.82
7100	12.75	0.97	5.06	10.13	20.17	40.40	60.65	81.33	101.53	112.19	122.69
7300	12.96	1.01	5.17	10.27	20.30	40.37	60.66	81.29	101.40	111.80	122.96
7400	13.05	1.02	5.22	10.33	20.37	40.36	60.58	81.21	101.26	111.33	122.33
7600	13.23	1.04	5.27	10.39	20.48	40.30	60.52	80.92	100.92	111.24	121.26
7700	13.34	1.05	5.27	10.39	20.51	40.24	60.41	80.76	100.75	110.94	120.98
7900	13.58	1.03	5.22	10.33	20.51	40.05	60.10	80.12	99.85	110.15	119.76
8000	13.71	1.02	5.20	10.29	20.50	39.93	59.93	79.93	99.62	109.74	119.01

FREQ. (MHz)	I. Loss (dB)	Attenuation relative to I. Loss Fine resolution (0.05 dB)														
		@ Attenuation setting (dB)														
		7.40	7.45	7.50	7.55	7.60	67.40	67.45	67.50	67.55	67.60	100.40	100.45	100.50	100.55	100.60
200	4.28	7.53	7.58	7.63	7.68	7.73	68.35	68.39	68.46	68.51	68.55	98.81	98.84	98.93	98.98	98.98
400	4.59	7.40	7.44	7.50	7.55	7.60	67.62	67.67	67.74	67.78	67.82	97.36	97.40	97.51	97.54	97.60
600	4.94	7.27	7.31	7.37	7.42	7.47	67.41	67.45	67.51	67.56	67.61	97.41	97.47	97.55	97.59	97.61
800	5.24	7.20	7.24	7.31	7.36	7.40	67.44	67.48	67.54	67.59	67.64	97.93	97.98	98.05	98.08	98.16
1000	5.47	7.21	7.26	7.32	7.37	7.42	67.61	67.65	67.71	67.76	67.81	98.45	98.49	98.56	98.60	98.70
1200	5.62	7.29	7.33	7.39	7.44	7.49	67.76	67.80	67.85	67.90	67.95	98.84	98.85	98.95	98.96	99.05
1400	5.84	7.36	7.41	7.47	7.52	7.56	67.99	68.04	68.08	68.13	68.18	99.25	99.32	99.37	99.40	99.43
1600	6.02	7.39	7.43	7.48	7.53	7.58	68.06	68.11	68.15	68.20	68.25	99.48	99.56	99.54	99.60	99.66
1800	6.12	7.38	7.42	7.46	7.52	7.57	68.03	68.07	68.11	68.16	68.21	99.63	99.67	99.77	99.75	99.81
2000	6.29	7.37	7.42	7.45	7.50	7.55	68.03	68.07	68.11	68.16	68.21	99.81	99.84	99.84	99.92	99.97
2400	6.60	7.47	7.52	7.53	7.59	7.64	68.16	68.20	68.24	68.29	68.34	100.21	100.22	100.27	100.31	100.35
2800	6.85	7.59	7.64	7.66	7.71	7.77	68.45	68.50	68.53	68.58	68.63	100.78	100.82	100.85	100.87	100.92
3200	7.16	7.51	7.56	7.60	7.65	7.70	68.50	68.55	68.56	68.62	68.68	101.34	101.36	101.44	101.44	101.50
3600	7.59	7.36	7.41	7.45	7.51	7.56	68.52	68.57	68.58	68.63	68.69	101.67	101.75	101.81	101.82	101.86
4000	7.97	7.33	7.38	7.41	7.47	7.52	68.58	68.64	68.64	68.70	68.76	102.10	102.10	102.12	102.25	102.23
4400	8.35	7.38	7.44	7.45	7.51	7.58	68.63	68.69	68.68	68.74	68.80	102.39	102.50	102.46	102.60	102.63
4800	8.90	7.33	7.39	7.38	7.45	7.51	68.50	68.57	68.55	68.62	68.68	102.58	102.66	102.76	102.68	102.71
5000	9.17	7.28	7.34	7.33	7.39	7.46	68.45	68.51	68.49	68.56	68.63	102.60	102.69	102.67	102.70	102.83
5400	9.58	7.31	7.37	7.34	7.41	7.47	68.46	68.52	68.50	68.57	68.64	102.86	102.89	102.75	102.90	102.92
5600	9.76	7.36	7.43	7.38	7.45	7.53	68.57	68.64	68.62	68.69	68.76	103.06	103.03	103.00	103.03	103.12
6000	10.26	7.44	7.52	7.44	7.52	7.59	68.67	68.74	68.72	68.79	68.87	103.13	103.23	103.12	103.13	103.13
6200	10.65	7.46	7.53	7.44	7.52	7.60	68.59	68.65	68.65	68.72	68.79	103.06	102.96	103.02	103.04	103.12
6400	11.14	7.45	7.52	7.43	7.51	7.59	68.36	68.42	68.43	68.50	68.57	102.72	102.78	102.79	102.77	102.77
6500	11.41	7.44	7.51	7.43	7.50	7.58	68.19	68.25	68.26	68.33	68.40	102.69	102.80	102.60	102.59	102.68
6700	11.95	7.44	7.50	7.43	7.50	7.57	67.82	67.88	67.90	67.97	68.04	102.12	102.18	102.12	102.25	102.23
6800	12.20	7.45	7.51	7.44	7.51	7.58	67.69	67.75	67.78	67.85	67.91	101.85	102.13	102.07	102.03	101.99
7000	12.61	7.51	7.57	7.51	7.58	7.64	67.53	67.59	67.62	67.69	67.75	101.50	101.70	101.70	101.67	101.70
7100	12.75	7.56	7.62	7.57	7.63	7.69	67.47	67.52	67.56	67.63	67.69	101.36	101.46	101.46	101.56	101.49
7300	12.96	7.67	7.72	7.67	7.73	7.79	67.38	67.43	67.49	67.55	67.61	101.27	101.12	101.19	101.23	101.34
7400	13.05	7.70	7.76	7.71	7.77	7.83	67.37	67.43	67.49	67.55	67.61	101.11	100.97	101.10	100.97	101.20
7600	13.23	7.73	7.78	7.73	7.79	7.85	67.24	67.29	67.36	67.42	67.48	100.63	100.70	100.63	100.60	100.69
7700	13.34	7.71	7.76	7.71	7.77	7.83	67.09	67.14	67.21	67.27	67.33	100.31	100.37	100.41	100.47	100.45
7900	13.58	7.63	7.68	7.63	7.69	7.74	66.69	66.74	66.82	66.88	66.94	99.58	99.79	99.72	99.69	99.81
8000	13.71	7.58	7.63	7.58	7.64	7.70	66.52	66.58	66.66	66.71	66.77	99.25	99.42	99.38	99.44	99.43

## Typical Performance Data (Continued)\*

\*at +25°C unless noted otherwise

FREQ. (MHz)	VSWR In (:1)												VSWR Out (:1)											
	@ Attenuation setting (dB)												@ Attenuation setting (dB)											
	0	1	5	10	20	40	60	80	100	110	120	0	1	5	10	20	40	60	80	100	110	120		
200	1.68	1.57	1.44	1.17	1.37	1.11	1.04	1.05	1.10	1.10	1.05	1.70	1.62	1.37	1.28	1.12	1.24	1.09	1.09	1.09	1.07	1.07		
400	1.43	1.37	1.35	1.12	1.35	1.10	1.01	1.03	1.09	1.09	1.02	1.45	1.41	1.27	1.23	1.08	1.24	1.07	1.08	1.08	1.04	1.04		
600	1.21	1.21	1.29	1.10	1.33	1.10	1.03	1.04	1.09	1.09	1.03	1.20	1.19	1.20	1.20	1.07	1.24	1.07	1.08	1.08	1.03	1.03		
800	1.15	1.19	1.27	1.08	1.32	1.10	1.05	1.05	1.09	1.09	1.05	1.04	1.06	1.20	1.21	1.07	1.24	1.06	1.08	1.08	1.03	1.03		
1000	1.27	1.29	1.30	1.07	1.31	1.10	1.07	1.05	1.09	1.09	1.07	1.20	1.19	1.26	1.25	1.08	1.24	1.06	1.08	1.08	1.03	1.03		
1200	1.38	1.38	1.33	1.07	1.30	1.09	1.08	1.06	1.08	1.08	1.08	1.36	1.33	1.33	1.30	1.08	1.24	1.06	1.08	1.08	1.03	1.03		
1400	1.40	1.40	1.33	1.07	1.29	1.09	1.08	1.07	1.08	1.08	1.09	1.43	1.40	1.38	1.34	1.10	1.24	1.07	1.09	1.09	1.03	1.03		
1600	1.34	1.35	1.30	1.06	1.27	1.08	1.08	1.07	1.07	1.07	1.09	1.43	1.41	1.39	1.36	1.11	1.25	1.08	1.09	1.09	1.04	1.04		
1800	1.23	1.25	1.25	1.04	1.25	1.07	1.09	1.06	1.06	1.06	1.09	1.41	1.42	1.41	1.37	1.12	1.25	1.08	1.09	1.09	1.04	1.04		
2000	1.13	1.16	1.20	1.03	1.23	1.05	1.09	1.07	1.05	1.05	1.10	1.46	1.47	1.44	1.38	1.13	1.25	1.08	1.10	1.10	1.04	1.04		
2400	1.16	1.16	1.19	1.01	1.20	1.03	1.09	1.06	1.03	1.03	1.10	1.68	1.66	1.53	1.43	1.14	1.25	1.09	1.10	1.10	1.05	1.05		
2800	1.30	1.26	1.23	1.02	1.20	1.03	1.08	1.05	1.03	1.02	1.08	1.64	1.61	1.50	1.43	1.14	1.25	1.10	1.11	1.11	1.06	1.06		
3200	1.35	1.30	1.26	1.06	1.21	1.05	1.06	1.03	1.04	1.04	1.06	1.29	1.30	1.34	1.34	1.12	1.25	1.10	1.12	1.12	1.07	1.07		
3600	1.33	1.30	1.26	1.09	1.21	1.07	1.03	1.02	1.07	1.07	1.03	1.07	1.08	1.17	1.26	1.09	1.24	1.10	1.13	1.13	1.08	1.08		
4000	1.30	1.28	1.26	1.06	1.22	1.09	1.04	1.04	1.09	1.09	1.04	1.17	1.15	1.08	1.23	1.06	1.22	1.11	1.13	1.13	1.08	1.08		
4400	1.09	1.12	1.18	1.04	1.21	1.11	1.08	1.10	1.10	1.10	1.09	1.13	1.14	1.11	1.18	1.07	1.21	1.11	1.14	1.14	1.09	1.09		
4800	1.20	1.17	1.16	1.12	1.20	1.13	1.14	1.15	1.13	1.13	1.14	1.17	1.18	1.24	1.19	1.12	1.22	1.11	1.14	1.14	1.10	1.10		
5000	1.32	1.26	1.17	1.15	1.18	1.14	1.17	1.19	1.14	1.14	1.18	1.25	1.24	1.29	1.21	1.14	1.23	1.12	1.15	1.15	1.11	1.11		
5400	1.30	1.23	1.12	1.18	1.16	1.17	1.26	1.28	1.19	1.19	1.26	1.28	1.27	1.31	1.22	1.14	1.23	1.13	1.17	1.17	1.13	1.13		
5600	1.17	1.11	1.05	1.20	1.16	1.20	1.30	1.32	1.22	1.22	1.30	1.24	1.24	1.27	1.19	1.13	1.23	1.14	1.18	1.18	1.14	1.14		
6000	1.18	1.17	1.17	1.28	1.17	1.25	1.37	1.39	1.27	1.27	1.38	1.16	1.15	1.16	1.08	1.08	1.21	1.16	1.21	1.21	1.18	1.18		
6200	1.35	1.33	1.29	1.37	1.21	1.30	1.41	1.43	1.31	1.31	1.42	1.15	1.14	1.15	1.06	1.10	1.19	1.18	1.23	1.23	1.20	1.20		
6400	1.54	1.49	1.40	1.46	1.25	1.35	1.46	1.48	1.36	1.35	1.47	1.24	1.23	1.24	1.11	1.15	1.17	1.19	1.25	1.25	1.22	1.22		
6500	1.62	1.57	1.45	1.51	1.27	1.37	1.48	1.49	1.38	1.37	1.49	1.31	1.30	1.31	1.16	1.18	1.17	1.20	1.26	1.26	1.24	1.24		
6700	1.76	1.69	1.53	1.59	1.31	1.41	1.51	1.53	1.41	1.41	1.52	1.50	1.48	1.47	1.27	1.26	1.16	1.22	1.28	1.28	1.26	1.26		
6800	1.80	1.72	1.56	1.62	1.33	1.44	1.53	1.54	1.43	1.43	1.54	1.59	1.57	1.55	1.32	1.30	1.15	1.23	1.28	1.29	1.27	1.27		
7000	1.77	1.70	1.57	1.65	1.36	1.48	1.57	1.57	1.47	1.47	1.58	1.72	1.70	1.68	1.41	1.37	1.15	1.25	1.30	1.30	1.29	1.29		
7100	1.71	1.65	1.56	1.65	1.37	1.50	1.59	1.58	1.49	1.49	1.59	1.76	1.74	1.72	1.44	1.40	1.15	1.26	1.31	1.31	1.31	1.31		
7300	1.50	1.48	1.49	1.62	1.39	1.53	1.62	1.60	1.52	1.53	1.62	1.77	1.77	1.76	1.48	1.44	1.14	1.27	1.32	1.32	1.33	1.33		
7400	1.39	1.39	1.45	1.60	1.40	1.54	1.63	1.61	1.54	1.54	1.63	1.76	1.76	1.75	1.48	1.44	1.14	1.28	1.32	1.32	1.33	1.33		
7600	1.23	1.28	1.40	1.56	1.41	1.56	1.64	1.61	1.57	1.57	1.64	1.68	1.69	1.68	1.45	1.43	1.12	1.29	1.32	1.32	1.35	1.35		
7700	1.25	1.29	1.40	1.54	1.42	1.57	1.64	1.61	1.58	1.58	1.65	1.64	1.64	1.63	1.42	1.41	1.11	1.29	1.32	1.32	1.36	1.36		
7900	1.42	1.42	1.44	1.55	1.46	1.58	1.64	1.59	1.59	1.59	1.65	1.52	1.52	1.50	1.33	1.36	1.09	1.30	1.31	1.31	1.36	1.36		
8000	1.52	1.50	1.47	1.56	1.47	1.58	1.64	1.58	1.60	1.60	1.65	1.45	1.45	1.42	1.28	1.33	1.08	1.30	1.30	1.30	1.36	1.36		



## Typical Performance Curves \*

\*at +25°C unless noted otherwise

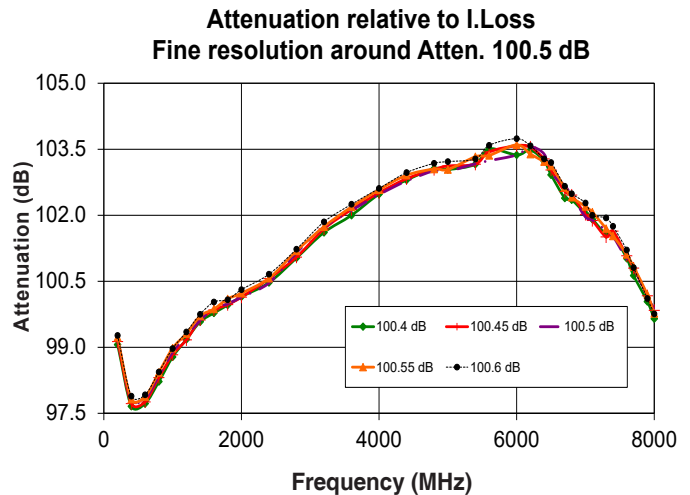
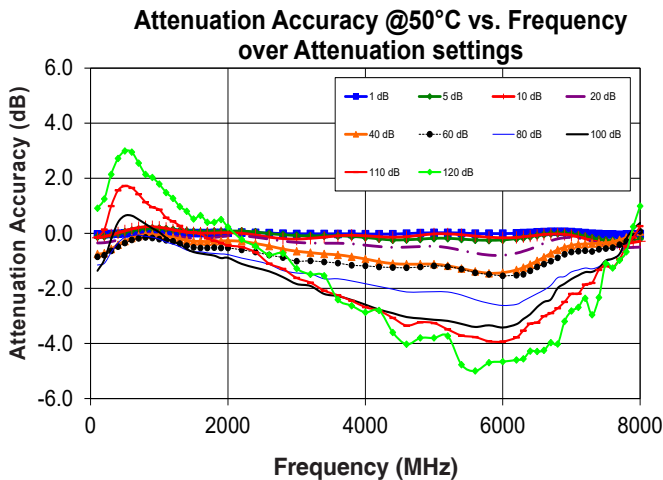
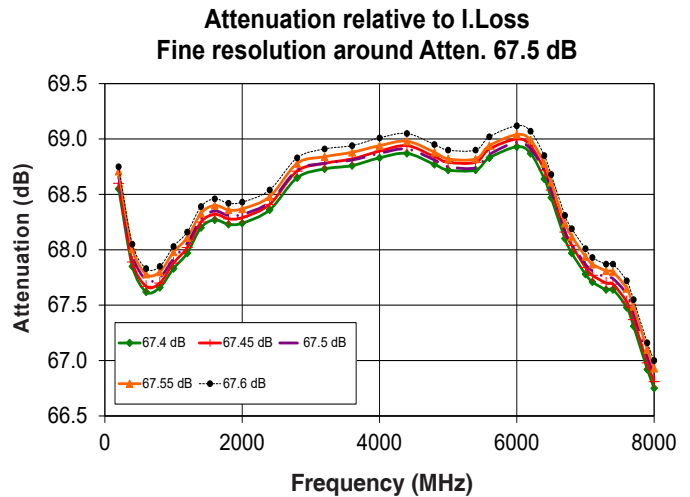
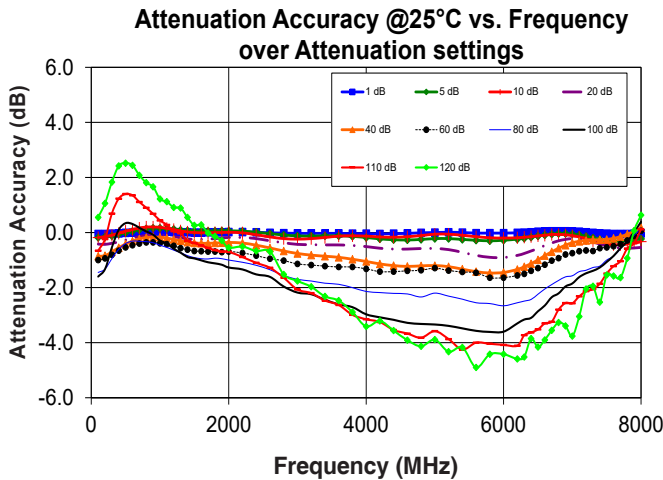
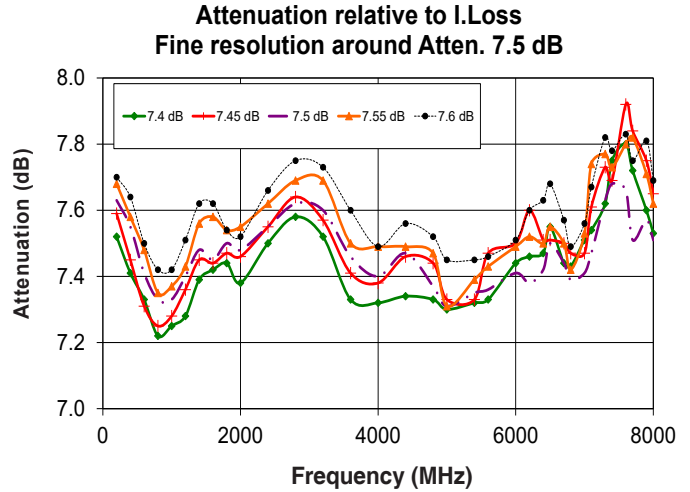
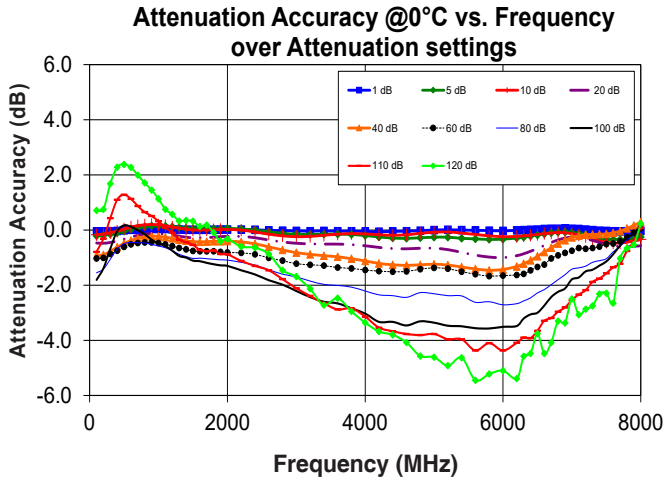

## Typical Performance Curves (Continued) \*

\*at +25°C unless noted otherwise

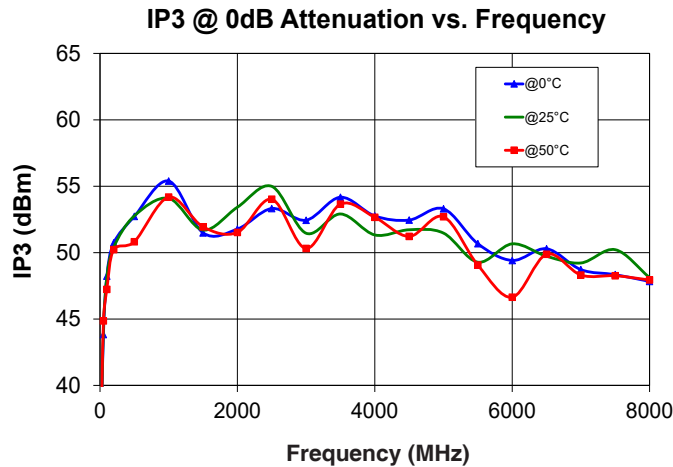
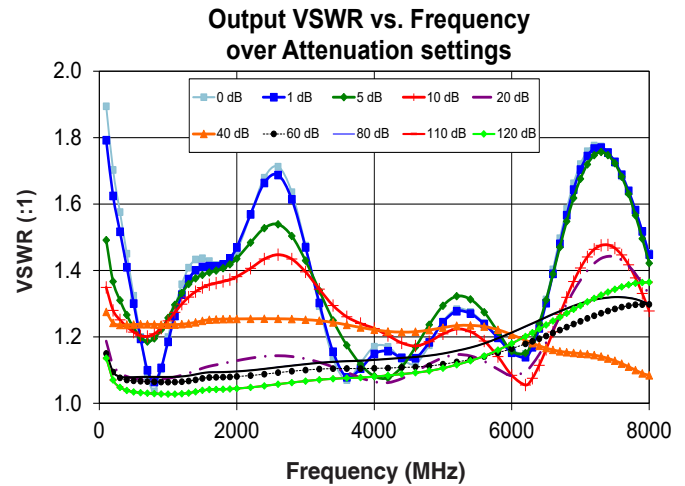
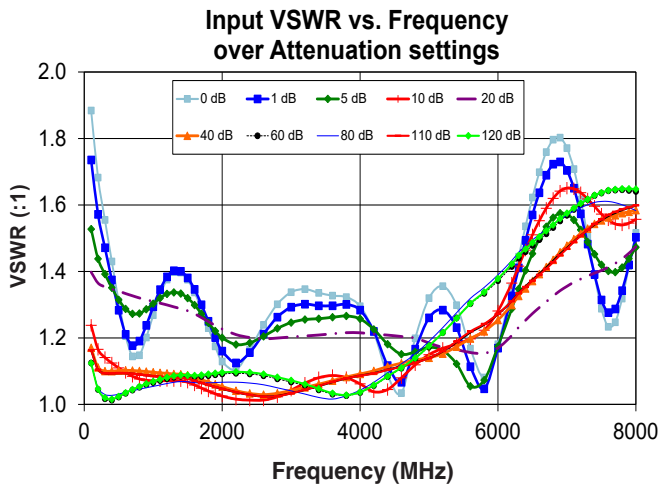
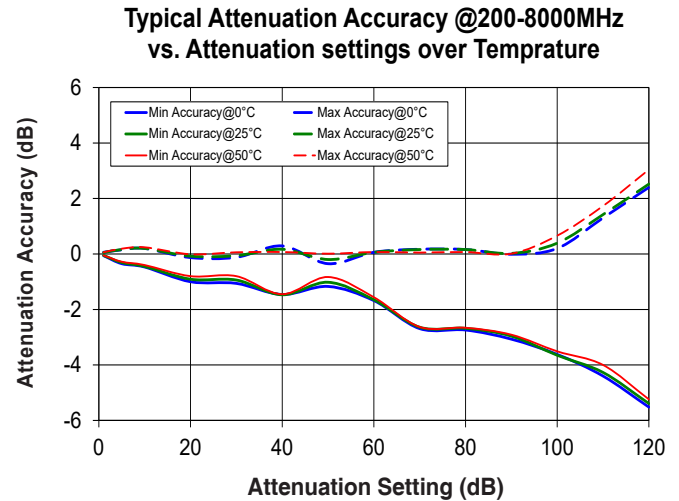
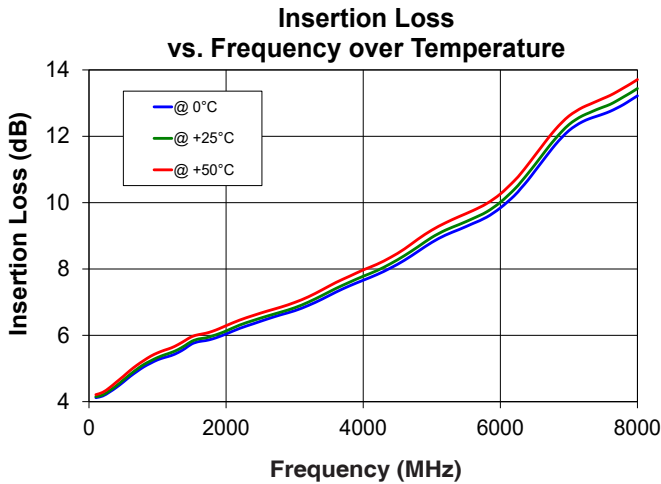

## Typical Performance Curves (Continued) \*

\*at +25°C unless noted otherwise

### Attenuation Accuracy @ 40dB setting vs. Frequency at all channels

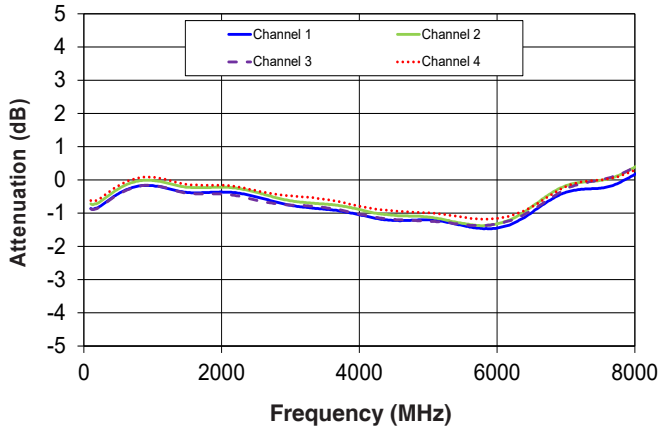

### Isolation between channels @0°C vs. Frequency

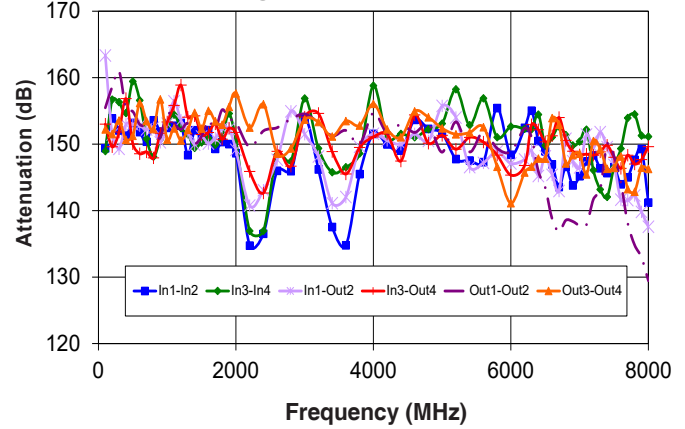

### Attenuation Accuracy @ 80dB setting vs. Frequency at all channels

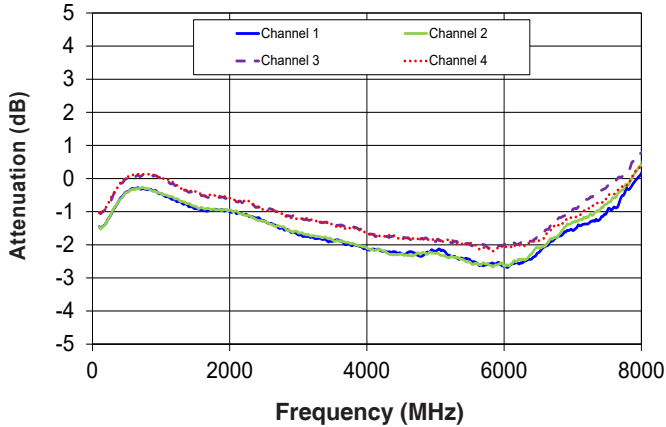

### Isolation between channels @+25°C vs. Frequency

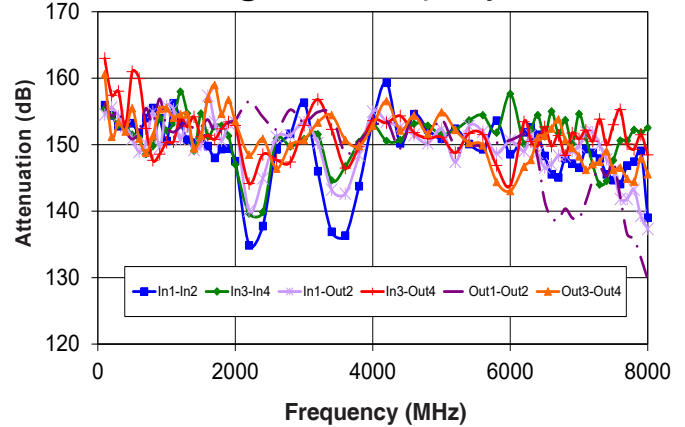

### Attenuation Accuracy @ 110dB setting vs. Frequency at all channels

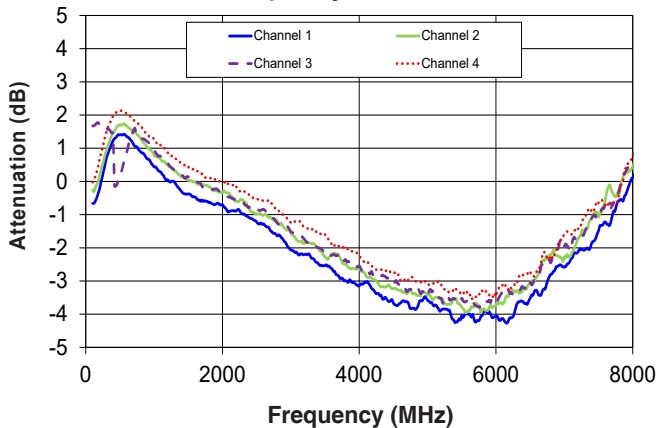

### Isolation between channels @+50°C vs. Frequency

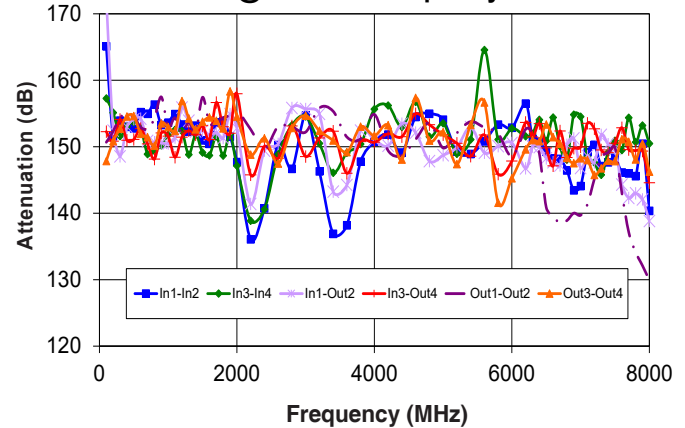

## Typical Transition times @ +25°C

Transition 20 dB to 0 dB,  
tested using Oscilloscope

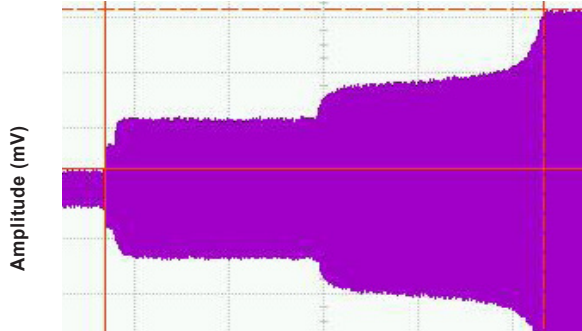

Time (ns)

Rise time at transition 20 to 0 dB:  
 $\Delta t$ : 927.3 ns ;  $\Delta V$ : 144.8 mV  
 Scale 200 ns/dev ; 50 mV/dev

Transition 0 dB to 20 dB,  
tested using Oscilloscope

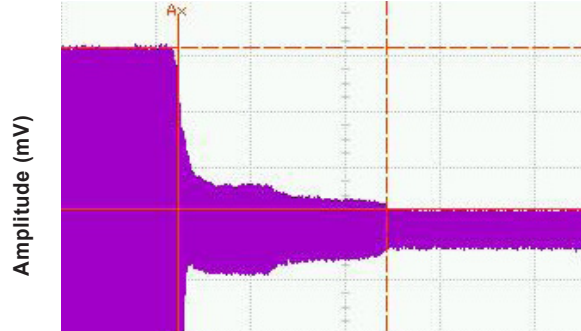

Time (ns)

Fall time at transition 0 to 20 dB:  
 $\Delta t$ : 440.4 ns ;  $\Delta V$ : 144.8 mV  
 Scale 200 ns/dev ; 50 mV/dev

Transition 20.2 dB to 20 dB,  
tested using Spectrum Analyzer

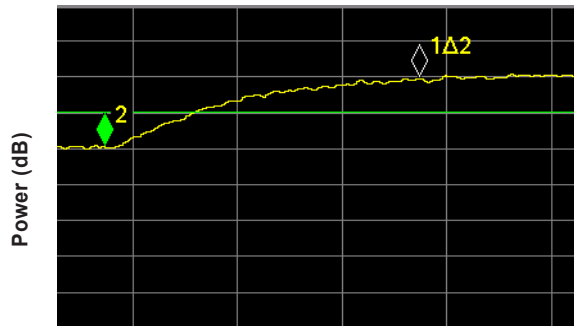

Time ( $\mu$ s)

Fall time at transition 20.2 to 20 dB:  
 $\Delta t$ : 6.02  $\mu$ s ;  $\Delta P$ : 0.19 dB  
 Scale 2  $\mu$ s/dev ; 0.1 dB/dev

Transition 20 dB to 20.2 dB,  
tested using Spectrum Analyzer

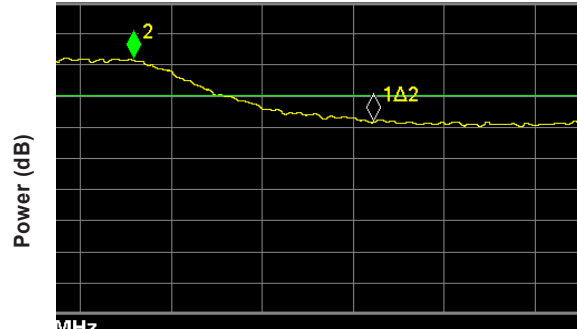

Time ( $\mu$ s)

Fall time at transition 20 to 20.2 dB:  
 $\Delta t$ : 5.28  $\mu$ s ;  $\Delta P$ : 0.20 dB  
 Scale 2  $\mu$ s/dev ; 0.1 dB/dev

Note: All transition time tests performed with input signal of 501 MHz, 0 dBm.

## Connecting multiple modules (Daisy Chain)

The RC4DAT-8G-120H is designed to connect up to 25 modules in series (Daisy chain) using dynamic addressing, meaning there is no need to specifically set the address of the modules, the addresses will be set automatically as part of establishing the communications with the PC. The module connected to the PC USB port or LAN connection will be assigned address 0 (Master), the first module connected to it will get address 1 (slave) and subsequent modules incrementing up to address 24 (slave).

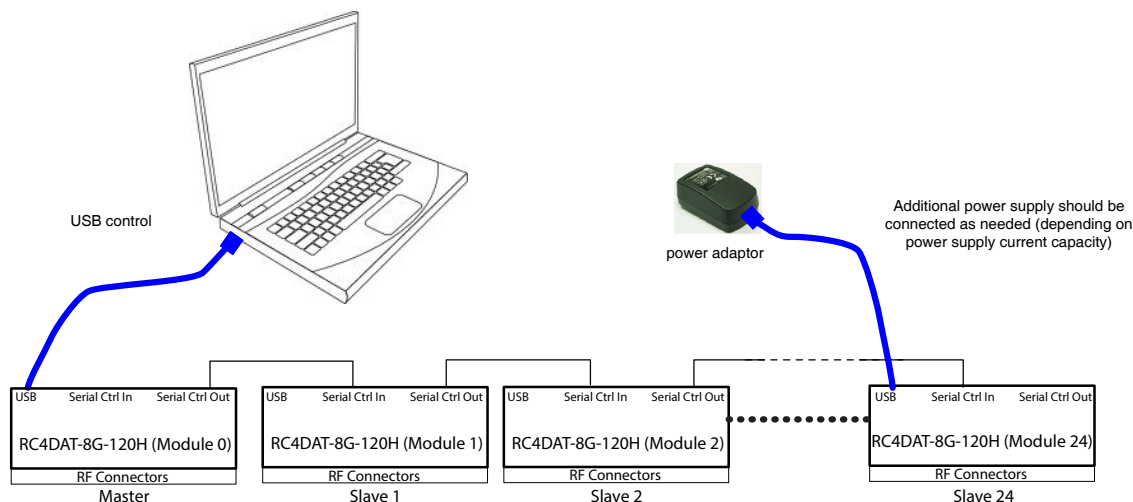

Connections between modules will be made using the serial in/out ports with the module connected to the PC as a master and all other as slave modules. All control will be through the master module (address zero) which is the only one communicating with the PC (via USB or Ethernet). Serial control out port of each module should be connected to the serial control in port of the next module. Power can be supplied from the PC via the master module or from additional power supplies connected to the USB ports of slave units.

Note that with Ethernet enabled each unit will draw up to 350 mA so to connect three units in series you will need to supply 1050mA, thus it is recommended to turn off the Ethernet circuitry in the slave units to reduce the power requirements. The max current pass through a single unit should be limited to 1000 mA so additional power supplies should be used as needed. Connecting an additional power supply will automatically cut off power draw from the serial control in port for the module connected.

The serial master/slave bus allows connecting modules of different types to the same daisy chain as long as all support Mini-Circuits dynamic addressing setup. To add a new module to the set up simply connect the module to the setup and refresh the address listing, no need to reset any of the existing modules or assign addresses manually.

Note: Using longer control cables between modules may reduce the max number of units connected in daisy chain.

## Controlling multiple modules in GUI program

Connect the attenuator you wish to use as master to either USB or LAN and connect additional units to the master using the serial control in/out ports and CBL-1.5FT-MMD+ or equivalent control cables, then start the GUI and select the control method you wish to use (USB, HTTP, Telnet, or SSH. RS232 is not available in this model.)

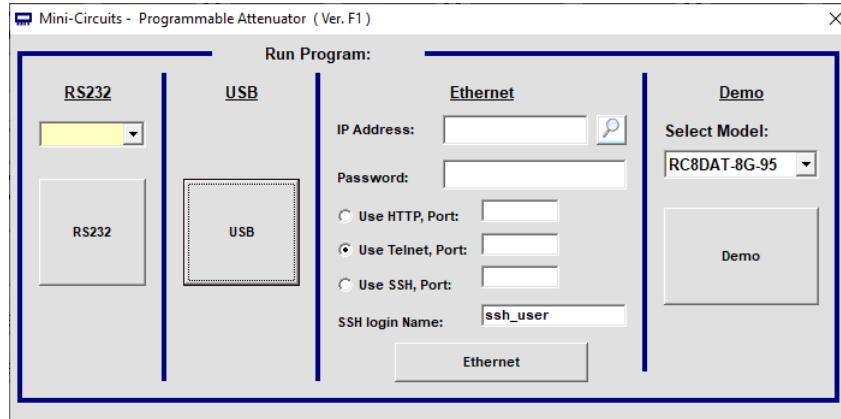

RC4DAT GUI initial (control selection) screen

Once you've selected the control method the main attenuation control screen will appear, allowing you to set a fixed attenuation, an arbitrary sequence of attenuation steps, or a sweep(ramp) of attenuation for each attenuator, or for a number of attenuators at once.

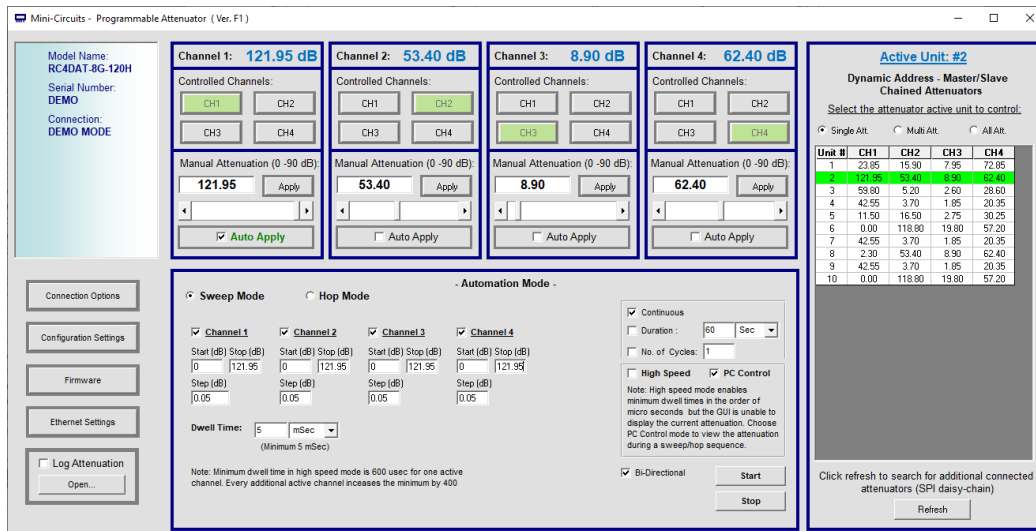

RC4DAT GUI main screen (USB control) with 10 units connected in series

## Software & Documentation Download:

- Mini-Circuits' full software and support package including user guide, Windows GUI, DLL files, programming manual and examples can be downloaded free of charge from <http://www.minicircuits.com/softwaredownload/patt.html>
- Please contact [testsolutions@minicircuits.com](mailto:testsolutions@minicircuits.com) for support

## Minimum System Requirements

Parameter	Requirements	
Interface	USB HID or HTTP Get/Post or Telnet protocols	
System requirements	GUI:	Windows 32 & 64 bit systems from Windows 98 up to Windows 10
	USB API (ActiveX & .Net)	Windows 32 & 64 bit systems with ActiveX or .Net support from Windows 98 up to Windows 10
	USB direct programming support	Linux, Windows systems from Windows 98 up to Windows 10
	HTTP or Telnet	Any computer with a network port and Ethernet-TCP/IP (HTTP or Telnet protocols) support
Hardware	Pentium® II or higher, RAM 256 MB	

## Graphical User Interface (GUI) for Windows

### Key Features:

- Manual attenuation setting
- Sweep and Hop attenuation sequences directed from the PC, or entire sequence loaded into RC4DAT.
- Attenuator address configuration and Firmware upgrade
- Attenuation at power up may be set to selected attenuation level or last attenuation state recorded.
- Controlling up to 25 units in 'daisy chain' configuration.
- USB, HTTP or Telnet control of RC4DAT
- Setting Ethernet configuration

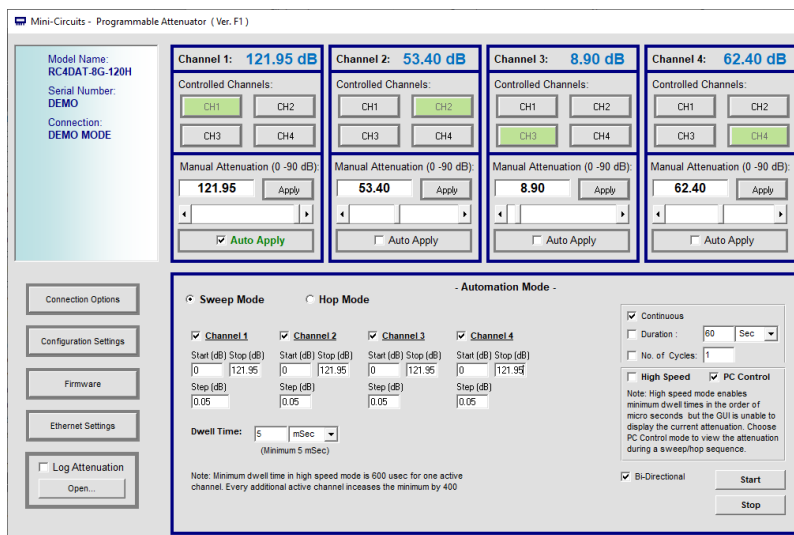

## Application Programming Interface (API)

Programming manual: [https://www.minicircuits.com/softwaredownload/Prog\\_Manual-6-Programmable\\_Attenuator.pdf](https://www.minicircuits.com/softwaredownload/Prog_Manual-6-Programmable_Attenuator.pdf)

### Windows Support:

- API DLL files exposing the full switch functionality
  - ActiveX COM DLL file for creation of 32-bit programs
  - .Net library DLL file for creation of 32 / 64-bit programs
- Supported by most common programming environments (refer to application note [AN-49-001](#) for summary of tested environments)

### Linux Support:

- Full attenuator control in a Linux environment is achieved by way of USB interrupt commands.



## Ordering Information

Model	Description
RC4DAT-8G-120H	USB/Ethernet four channel Programmable Attenuator

Included Accessories	Part No.	Description
	MUSB-CBL-3+	3.3 ft (1.0 m) USB Cable: USB type A(Male) to USB type Mini-B(Male)

Optional Accessories	Description
USB-AC/DC-5	AC/DC 5V <sub>DC</sub> Power Adapter with US, EU, IL, UK, AUS, and China power plugs <sup>10,11</sup>
MUSB-CBL-3+ (spare)	3.3 ft (1.0 m) USB Cable: USB type A(Male) to USB type Mini-B(Male)
MUSB-CBL-7+	6.6 ft (2.0 m) USB Cable: USB type A(Male) to USB type Mini-B(Male)
CBL-RJ45-MM-5+	5 ft (1.5 m) Ethernet cable: RJ45(Male) to RJ45(Male) Cat 5E cable
CBL-1.5FT-MMD+	1.5 ft (0.5 m) Digital Snap Fit(male-male) cable assembly(daisy chain)
CBL-5FT-MMD+	5 ft (1.5 m) Digital Snap Fit(male-male) cable assembly(daisy chain)
BKT-355-02+	Bracket kit including 3.75" x 5.17" bracket, mounting screws and washers

<sup>10</sup> The USB-AC/DC-5 may be used to provide the 5V<sub>DC</sub> power input via USB port if operating the RC4DAT with Ethernet control. Not required if using USB control.

<sup>11</sup> Power plugs for other countries are also available, Plugs for other countries are also available, if you need a power plug for a country not listed please contact [testsolutions@minicircuits.com](mailto:testsolutions@minicircuits.com)

## Additional Notes

- A. Performance and quality attributes and conditions not expressly stated in this specification document are intended to be excluded and do not form a part of this specification document.
- B. Electrical specifications and performance data contained in this specification document are based on Mini-Circuit's applicable established test performance criteria and measurement instructions.
- C. The parts covered by this specification document are subject to Mini-Circuits standard limited warranty and terms and conditions (collectively, "Standard Terms"); Purchasers of this part are entitled to the rights and benefits contained therein. For a full statement of the Standard Terms and the exclusive rights and remedies thereunder, please visit Mini-Circuits' website at [www.minicircuits.com/MCLStore/terms.jsp](http://www.minicircuits.com/MCLStore/terms.jsp)



# Programmable Attenuator RC4DAT-8G-120H

## Typical Performance Data @ 0°C

FREQUENCY (MHz)	Attenuation relative to Insertion Loss (dB)									
	1 dB	5 dB	10 dB	20 dB	40 dB	60 dB	80 dB	100 dB	110 dB	120 dB
100	1.06	5.14	10.17	20.22	40.10	59.79	79.59	99.69	108.57	116.93
200	1.07	5.15	10.17	20.28	40.23	59.95	79.70	99.61	108.43	116.82
300	1.07	5.14	10.16	20.28	40.13	59.85	79.34	98.84	107.63	115.90
400	1.06	5.11	10.12	20.26	40.02	59.74	79.06	98.27	107.06	115.33
500	1.05	5.06	10.07	20.21	39.91	59.66	78.88	98.01	106.86	115.38
600	1.03	5.01	10.02	20.16	39.82	59.60	78.90	98.02	106.92	115.46
700	1.02	4.96	9.97	20.10	39.75	59.55	78.89	98.14	107.07	115.68
800	1.01	4.91	9.94	20.05	39.70	59.53	78.87	98.29	107.31	115.95
900	1.00	4.88	9.92	20.01	39.67	59.52	78.83	98.47	107.53	116.41
1000	0.99	4.86	9.92	20.00	39.67	59.55	78.99	98.61	107.73	116.54
1100	0.99	4.85	9.94	20.01	39.69	59.59	79.05	98.75	107.90	116.63
1200	1.00	4.85	9.99	20.03	39.73	59.66	79.13	98.91	108.11	116.84
1300	1.00	4.87	10.04	20.07	39.78	59.75	79.27	99.04	108.33	117.22
1400	1.00	4.89	10.09	20.12	39.84	59.84	79.40	99.19	108.46	117.55
1500	1.01	4.90	10.12	20.15	39.89	59.89	79.47	99.29	108.61	117.57
1600	1.01	4.91	10.13	20.15	39.90	59.92	79.61	99.38	108.71	117.74
1700	1.00	4.91	10.13	20.15	39.91	59.94	79.57	99.45	108.79	117.95
1800	1.00	4.92	10.14	20.15	39.91	59.97	79.58	99.53	108.84	117.94
1900	1.00	4.93	10.14	20.16	39.92	59.98	79.58	99.59	108.94	118.22
2000	1.00	4.95	10.16	20.17	39.94	60.02	79.62	99.67	109.02	118.31
2200	1.01	5.01	10.22	20.24	40.02	60.11	79.84	99.81	109.25	118.32
2400	1.03	5.08	10.29	20.33	40.11	60.21	79.95	99.99	109.42	118.72
2600	1.05	5.12	10.31	20.36	40.15	60.24	79.98	100.08	109.60	118.79
2800	1.05	5.11	10.25	20.33	40.12	60.19	80.04	100.19	109.70	119.39
3000	1.05	5.08	10.18	20.27	40.09	60.16	79.95	100.35	109.95	119.89
3200	1.05	5.07	10.13	20.25	40.09	60.15	80.04	100.47	110.07	119.98
3400	1.05	5.09	10.11	20.26	40.13	60.16	80.28	100.59	110.35	120.33
3600	1.06	5.14	10.12	20.31	40.20	60.23	80.19	100.81	110.50	120.69
3800	1.06	5.18	10.14	20.37	40.29	60.31	80.37	100.95	110.72	121.27
4000	1.06	5.22	10.17	20.42	40.38	60.33	80.37	101.14	110.95	121.22
4200	1.06	5.24	10.20	20.46	40.45	60.41	80.47	101.38	111.18	121.63
4400	1.05	5.26	10.21	20.48	40.51	60.42	80.69	101.47	111.37	122.06
4600	1.04	5.26	10.21	20.49	40.54	60.40	80.42	101.57	111.57	122.24
4800	1.03	5.24	10.19	20.48	40.54	60.40	80.60	101.63	111.63	122.60
5000	1.01	5.23	10.17	20.47	40.54	60.35	80.70	101.65	111.60	122.53
5200	1.01	5.23	10.15	20.49	40.55	60.34	80.58	101.70	111.70	122.70
5400	1.01	5.24	10.13	20.51	40.55	60.32	80.66	101.77	111.82	123.06
5600	1.01	5.24	10.13	20.56	40.56	60.38	80.90	101.87	112.02	122.57
5800	1.02	5.24	10.16	20.59	40.57	60.45	80.77	101.90	111.89	123.93
6000	1.01	5.18	10.11	20.54	40.49	60.43	80.68	101.89	112.01	123.79
6200	1.00	5.13	10.09	20.47	40.37	60.37	80.81	101.69	111.71	123.21
6300	0.99	5.10	10.08	20.44	40.31	60.34	80.62	101.65	111.78	123.22
6400	0.98	5.08	10.09	20.39	40.25	60.32	80.59	101.60	111.81	123.22
6500	0.98	5.05	10.09	20.33	40.16	60.28	80.94	101.52	111.57	123.08
6600	0.97	5.02	10.07	20.23	40.05	60.21	80.59	101.38	111.48	123.18
6700	0.95	4.99	10.05	20.12	39.92	60.11	80.54	101.15	111.22	121.98
6800	0.94	4.97	10.05	20.03	39.81	60.02	80.32	100.96	111.19	122.19
6900	0.94	4.97	10.06	19.98	39.72	59.92	80.27	100.79	111.06	123.05
7000	0.95	4.99	10.09	19.96	39.67	59.89	80.27	100.63	110.87	122.11
7100	0.96	5.03	10.14	19.97	39.63	59.86	80.03	100.54	110.83	121.90
7200	0.97	5.06	10.18	19.98	39.61	59.81	80.36	100.45	110.64	122.21
7300	0.99	5.10	10.24	20.01	39.59	59.79	79.79	100.39	110.58	121.69
7400	1.01	5.15	10.30	20.06	39.60	59.80	79.84	100.25	110.28	121.25
7500	1.02	5.19	10.36	20.14	39.62	59.84	79.64	100.09	110.13	121.81
7600	1.04	5.22	10.40	20.20	39.65	59.84	79.80	100.01	109.92	121.31
7700	1.05	5.23	10.43	20.27	39.67	59.81	79.86	99.85	109.65	120.69
7800	1.05	5.22	10.43	20.31	39.67	59.74	79.85	99.60	109.45	120.14
7900	1.04	5.19	10.40	20.32	39.62	59.65	79.60	99.37	109.21	119.63
8000	1.04	5.16	10.35	20.32	39.57	59.56	79.39	99.11	109.00	119.12

**Notes**

- A. Performance and quality attributes and conditions not expressly stated in this specification document are intended to be excluded and do not form a part of this specification document.
- B. Electrical specifications and performance data contained in this specification document are based on Mini-Circuit's applicable established test performance criteria and measurement instructions.
- C. The parts covered by this specification document are subject to Mini-Circuits standard limited warranty and terms and conditions (collectively, "Standard Terms"); Purchasers of this part are entitled to the rights and benefits contained therein. For a full statement of the Standard Terms and the exclusive rights and remedies thereunder, please visit Mini-Circuits' website at [www.minicircuits.com/MC1Store/terms.jsp](http://www.minicircuits.com/MC1Store/terms.jsp)



# Programmable Attenuator RC4DAT-8G-120H

## Typical Performance Data @ 0°C

FREQUENCY (MHz)	Attenuation accuracy relative to nominal attenuation setting (dB)									
	1 dB	5 dB	10 dB	20 dB	40 dB	60 dB	80 dB	100 dB	110 dB	120 dB
100	-0.06	-0.14	-0.17	-0.22	-0.10	0.21	0.41	0.31	1.43	3.07
200	-0.07	-0.15	-0.17	-0.28	-0.23	0.05	0.30	0.39	1.57	3.18
300	-0.07	-0.14	-0.16	-0.28	-0.13	0.15	0.66	1.16	2.37	4.10
400	-0.06	-0.11	-0.12	-0.26	-0.02	0.26	0.94	1.73	2.94	4.67
500	-0.05	-0.06	-0.07	-0.21	0.09	0.34	1.12	1.99	3.14	4.62
600	-0.03	-0.01	-0.02	-0.16	0.18	0.40	1.10	1.98	3.08	4.54
700	-0.02	0.04	0.03	-0.10	0.25	0.45	1.11	1.86	2.93	4.32
800	-0.01	0.09	0.06	-0.05	0.30	0.47	1.13	1.71	2.69	4.05
900	0.00	0.12	0.08	-0.01	0.33	0.48	1.17	1.53	2.47	3.59
1000	0.01	0.14	0.08	0.00	0.33	0.45	1.01	1.39	2.27	3.46
1100	0.01	0.15	0.06	-0.01	0.31	0.41	0.95	1.25	2.10	3.37
1200	0.00	0.15	0.01	-0.03	0.27	0.34	0.87	1.09	1.89	3.16
1300	0.00	0.13	-0.04	-0.07	0.22	0.25	0.73	0.96	1.67	2.78
1400	0.00	0.11	-0.09	-0.12	0.16	0.16	0.60	0.81	1.54	2.45
1500	-0.01	0.10	-0.12	-0.15	0.11	0.11	0.53	0.71	1.39	2.43
1600	-0.01	0.09	-0.13	-0.15	0.10	0.08	0.39	0.62	1.29	2.26
1700	0.00	0.09	-0.13	-0.15	0.09	0.06	0.43	0.55	1.21	2.05
1800	0.00	0.08	-0.14	-0.15	0.09	0.03	0.42	0.47	1.16	2.06
1900	0.00	0.07	-0.14	-0.16	0.08	0.02	0.42	0.41	1.06	1.78
2000	0.00	0.05	-0.16	-0.17	0.06	-0.02	0.38	0.33	0.98	1.69
2200	-0.01	-0.01	-0.22	-0.24	-0.02	-0.11	0.16	0.19	0.75	1.68
2400	-0.03	-0.08	-0.29	-0.33	-0.11	-0.21	0.05	0.01	0.58	1.28
2600	-0.05	-0.12	-0.31	-0.36	-0.15	-0.24	0.02	-0.08	0.40	1.21
2800	-0.05	-0.11	-0.25	-0.33	-0.12	-0.19	-0.04	-0.19	0.30	0.61
3000	-0.05	-0.08	-0.18	-0.27	-0.09	-0.16	0.05	-0.35	0.05	0.11
3200	-0.05	-0.07	-0.13	-0.25	-0.09	-0.15	-0.04	-0.47	-0.07	0.02
3400	-0.05	-0.09	-0.11	-0.26	-0.13	-0.16	-0.28	-0.59	-0.35	-0.33
3600	-0.06	-0.14	-0.12	-0.31	-0.20	-0.23	-0.19	-0.81	-0.50	-0.69
3800	-0.06	-0.18	-0.14	-0.37	-0.29	-0.31	-0.37	-0.95	-0.72	-1.27
4000	-0.06	-0.22	-0.17	-0.42	-0.38	-0.33	-0.37	-1.14	-0.95	-1.22
4200	-0.06	-0.24	-0.20	-0.46	-0.45	-0.41	-0.47	-1.38	-1.18	-1.63
4400	-0.05	-0.26	-0.21	-0.48	-0.51	-0.42	-0.69	-1.47	-1.37	-2.06
4600	-0.04	-0.26	-0.21	-0.49	-0.54	-0.40	-0.42	-1.57	-1.57	-2.24
4800	-0.03	-0.24	-0.19	-0.48	-0.54	-0.40	-0.60	-1.63	-1.63	-2.60
5000	-0.01	-0.23	-0.17	-0.47	-0.54	-0.35	-0.70	-1.65	-1.60	-2.53
5200	-0.01	-0.23	-0.15	-0.49	-0.55	-0.34	-0.58	-1.70	-1.70	-2.70
5400	-0.01	-0.24	-0.13	-0.51	-0.55	-0.32	-0.66	-1.77	-1.82	-3.06
5600	-0.01	-0.24	-0.13	-0.56	-0.56	-0.38	-0.90	-1.87	-2.02	-2.57
5800	-0.02	-0.24	-0.16	-0.59	-0.57	-0.45	-0.77	-1.90	-1.89	-3.93
6000	-0.01	-0.18	-0.11	-0.54	-0.49	-0.43	-0.68	-1.89	-2.01	-3.79
6200	0.00	-0.13	-0.09	-0.47	-0.37	-0.37	-0.81	-1.69	-1.71	-3.21
6300	0.01	-0.10	-0.08	-0.44	-0.31	-0.34	-0.62	-1.65	-1.78	-3.22
6400	0.02	-0.08	-0.09	-0.39	-0.25	-0.32	-0.59	-1.60	-1.81	-3.22
6500	0.02	-0.05	-0.09	-0.33	-0.16	-0.28	-0.94	-1.52	-1.57	-3.08
6600	0.03	-0.02	-0.07	-0.23	-0.05	-0.21	-0.59	-1.38	-1.48	-3.18
6700	0.05	0.01	-0.05	-0.12	0.08	-0.11	-0.54	-1.15	-1.22	-1.98
6800	0.06	0.03	-0.05	-0.03	0.19	-0.02	-0.32	-0.96	-1.19	-2.19
6900	0.06	0.03	-0.06	0.02	0.28	0.08	-0.27	-0.79	-1.06	-3.05
7000	0.05	0.01	-0.09	0.04	0.33	0.11	-0.27	-0.63	-0.87	-2.11
7100	0.04	-0.03	-0.14	0.03	0.37	0.14	-0.03	-0.54	-0.83	-1.90
7200	0.03	-0.06	-0.18	0.02	0.39	0.19	-0.36	-0.45	-0.64	-2.21
7300	0.01	-0.10	-0.24	-0.01	0.41	0.21	0.21	-0.39	-0.58	-1.69
7400	-0.01	-0.15	-0.30	-0.06	0.40	0.20	0.16	-0.25	-0.28	-1.25
7500	-0.02	-0.19	-0.36	-0.14	0.38	0.16	0.36	-0.09	-0.13	-1.81
7600	-0.04	-0.22	-0.40	-0.20	0.35	0.16	0.20	-0.01	0.08	-1.31
7700	-0.05	-0.23	-0.43	-0.27	0.33	0.19	0.14	0.15	0.35	-0.69
7800	-0.05	-0.22	-0.43	-0.31	0.33	0.26	0.15	0.40	0.55	-0.14
7900	-0.04	-0.19	-0.40	-0.32	0.38	0.35	0.40	0.63	0.79	0.37
8000	-0.04	-0.16	-0.35	-0.32	0.43	0.44	0.61	0.89	1.00	0.88

**Notes**

- A. Performance and quality attributes and conditions not expressly stated in this specification document are intended to be excluded and do not form a part of this specification document.
- B. Electrical specifications and performance data contained in this specification document are based on Mini-Circuits' applicable established test performance criteria and measurement instructions.
- C. The parts covered by this specification document are subject to Mini-Circuits' standard limited warranty and terms and conditions (collectively, "Standard Terms"); Purchasers of this part are entitled to the rights and benefits contained therein. For a full statement of the Standard Terms and the exclusive rights and remedies thereunder, please visit Mini-Circuits' website at [www.minicircuits.com/ACL/Store/terms.jsp](http://www.minicircuits.com/ACL/Store/terms.jsp)



# Programmable Attenuator RC4DAT-8G-120H

## Typical Performance Data @ 0°C

FREQUENCY (MHz)	Input VSWR (:1)									
	1 dB	5 dB	10 dB	20 dB	40 dB	60 dB	80 dB	100 dB	110 dB	120 dB
100	1.67	1.47	1.22	1.33	1.17	1.14	1.13	1.16	1.14	1.14
200	1.47	1.35	1.12	1.28	1.08	1.05	1.03	1.07	1.06	1.06
300	1.39	1.31	1.09	1.27	1.06	1.04	1.01	1.06	1.04	1.04
400	1.31	1.27	1.07	1.25	1.06	1.05	1.03	1.05	1.06	1.06
500	1.24	1.25	1.06	1.25	1.06	1.06	1.04	1.05	1.06	1.06
600	1.18	1.24	1.06	1.25	1.07	1.07	1.05	1.06	1.07	1.07
700	1.15	1.24	1.06	1.25	1.08	1.08	1.06	1.07	1.08	1.08
800	1.16	1.24	1.06	1.25	1.08	1.09	1.07	1.07	1.10	1.10
900	1.20	1.26	1.06	1.24	1.08	1.10	1.08	1.07	1.10	1.10
1000	1.26	1.28	1.06	1.24	1.09	1.11	1.09	1.08	1.11	1.11
1100	1.30	1.30	1.07	1.24	1.09	1.12	1.11	1.08	1.13	1.13
1200	1.33	1.30	1.08	1.22	1.10	1.14	1.12	1.09	1.15	1.15
1300	1.32	1.29	1.08	1.21	1.09	1.16	1.14	1.09	1.16	1.16
1400	1.30	1.27	1.07	1.19	1.09	1.16	1.14	1.09	1.17	1.17
1500	1.26	1.24	1.07	1.17	1.08	1.17	1.14	1.09	1.17	1.17
1600	1.22	1.21	1.06	1.16	1.07	1.16	1.14	1.08	1.17	1.17
1700	1.19	1.19	1.05	1.15	1.06	1.16	1.14	1.07	1.17	1.17
1800	1.14	1.17	1.05	1.14	1.05	1.16	1.14	1.07	1.17	1.17
1900	1.10	1.14	1.06	1.13	1.05	1.17	1.14	1.07	1.17	1.17
2000	1.06	1.12	1.07	1.11	1.06	1.18	1.15	1.08	1.18	1.18
2200	1.07	1.11	1.08	1.10	1.06	1.18	1.16	1.08	1.19	1.19
2400	1.12	1.12	1.09	1.09	1.07	1.19	1.16	1.08	1.19	1.19
2600	1.18	1.15	1.09	1.11	1.08	1.18	1.15	1.08	1.19	1.19
2800	1.22	1.18	1.09	1.13	1.08	1.16	1.13	1.07	1.17	1.17
3000	1.21	1.18	1.07	1.14	1.06	1.14	1.11	1.06	1.14	1.14
3200	1.19	1.16	1.08	1.13	1.07	1.15	1.12	1.07	1.15	1.15
3400	1.22	1.19	1.10	1.14	1.08	1.14	1.12	1.08	1.15	1.15
3600	1.28	1.22	1.13	1.16	1.09	1.13	1.10	1.08	1.13	1.13
3800	1.29	1.23	1.12	1.17	1.07	1.10	1.07	1.07	1.10	1.10
4000	1.25	1.21	1.10	1.17	1.06	1.07	1.05	1.06	1.08	1.08
4200	1.16	1.17	1.07	1.16	1.04	1.06	1.05	1.04	1.06	1.06
4400	1.08	1.14	1.04	1.17	1.04	1.06	1.04	1.04	1.06	1.06
4600	1.05	1.13	1.02	1.18	1.05	1.05	1.05	1.04	1.05	1.05
4800	1.16	1.15	1.06	1.19	1.07	1.07	1.08	1.05	1.07	1.07
5000	1.26	1.17	1.11	1.18	1.08	1.12	1.14	1.08	1.12	1.12
5200	1.26	1.14	1.11	1.14	1.08	1.16	1.18	1.09	1.16	1.16
5400	1.26	1.13	1.09	1.13	1.08	1.16	1.18	1.09	1.16	1.16
5600	1.21	1.10	1.12	1.17	1.13	1.20	1.24	1.14	1.21	1.21
5800	1.07	1.06	1.21	1.18	1.22	1.32	1.35	1.24	1.32	1.32
6000	1.21	1.19	1.29	1.18	1.27	1.38	1.40	1.28	1.38	1.38
6200	1.38	1.31	1.37	1.18	1.30	1.40	1.42	1.31	1.41	1.41
6300	1.44	1.35	1.39	1.18	1.30	1.40	1.42	1.31	1.41	1.41
6400	1.47	1.36	1.40	1.18	1.30	1.39	1.40	1.30	1.40	1.39
6500	1.49	1.38	1.42	1.18	1.30	1.39	1.40	1.30	1.39	1.39
6600	1.54	1.42	1.46	1.21	1.33	1.42	1.43	1.32	1.42	1.42
6700	1.62	1.48	1.52	1.25	1.37	1.46	1.47	1.37	1.46	1.46
6800	1.70	1.56	1.60	1.30	1.44	1.52	1.53	1.43	1.52	1.53
6900	1.77	1.62	1.67	1.35	1.50	1.58	1.59	1.49	1.59	1.59
7000	1.77	1.64	1.71	1.38	1.55	1.63	1.62	1.54	1.64	1.64
7100	1.70	1.61	1.71	1.39	1.57	1.65	1.63	1.56	1.65	1.65
7200	1.58	1.54	1.65	1.37	1.55	1.63	1.60	1.55	1.63	1.63
7300	1.45	1.46	1.59	1.35	1.53	1.60	1.57	1.52	1.60	1.60
7400	1.36	1.41	1.56	1.34	1.52	1.60	1.57	1.52	1.60	1.60
7500	1.27	1.36	1.53	1.34	1.53	1.60	1.57	1.53	1.61	1.61
7600	1.23	1.35	1.53	1.36	1.55	1.62	1.59	1.56	1.63	1.63
7700	1.24	1.36	1.55	1.40	1.59	1.67	1.62	1.60	1.68	1.68
7800	1.30	1.39	1.58	1.46	1.64	1.72	1.67	1.66	1.73	1.73
7900	1.39	1.43	1.60	1.50	1.68	1.75	1.69	1.70	1.76	1.76
8000	1.48	1.45	1.60	1.52	1.68	1.75	1.67	1.70	1.76	1.76

**Notes**

- A. Performance and quality attributes and conditions not expressly stated in this specification document are intended to be excluded and do not form a part of this specification document.
- B. Electrical specifications and performance data contained in this specification document are based on Mini-Circuit's applicable established test performance criteria and measurement instructions.
- C. The parts covered by this specification document are subject to Mini-Circuits standard limited warranty and terms and conditions (collectively, "Standard Terms"). Purchasers of this part are entitled to the rights and benefits contained therein. For a full statement of the Standard Terms and the exclusive rights and remedies thereunder, please visit Mini-Circuits' website at [www.minicircuits.com/MC1Store/terms.jsp](http://www.minicircuits.com/MC1Store/terms.jsp)



# Programmable Attenuator RC4DAT-8G-120H

## Typical Performance Data @ 0°C

FREQUENCY (MHz)	Output VSWR (:1)									
	1 dB	5 dB	10 dB	20 dB	40 dB	60 dB	80 dB	100 dB	110 dB	120 dB
100	1.72	1.43	1.32	1.19	1.28	1.16	1.17	1.17	1.17	1.14
200	1.50	1.25	1.22	1.09	1.23	1.09	1.09	1.09	1.09	1.06
300	1.40	1.21	1.20	1.07	1.22	1.07	1.08	1.08	1.08	1.04
400	1.31	1.18	1.18	1.06	1.21	1.06	1.07	1.07	1.07	1.03
500	1.21	1.18	1.18	1.06	1.21	1.06	1.07	1.07	1.07	1.03
600	1.13	1.19	1.19	1.07	1.21	1.06	1.07	1.07	1.07	1.03
700	1.06	1.21	1.20	1.08	1.21	1.06	1.08	1.08	1.08	1.04
800	1.08	1.25	1.22	1.09	1.20	1.06	1.08	1.08	1.08	1.04
900	1.15	1.28	1.24	1.09	1.20	1.06	1.08	1.07	1.07	1.05
1000	1.23	1.32	1.26	1.09	1.19	1.06	1.08	1.08	1.08	1.05
1100	1.30	1.36	1.28	1.10	1.19	1.07	1.08	1.08	1.08	1.06
1200	1.36	1.38	1.30	1.10	1.18	1.07	1.08	1.08	1.08	1.07
1300	1.39	1.39	1.30	1.10	1.17	1.07	1.09	1.08	1.08	1.08
1400	1.39	1.37	1.29	1.09	1.16	1.07	1.08	1.08	1.08	1.08
1500	1.37	1.35	1.28	1.08	1.15	1.07	1.08	1.08	1.08	1.08
1600	1.35	1.33	1.27	1.06	1.14	1.06	1.07	1.07	1.07	1.08
1700	1.33	1.31	1.25	1.05	1.12	1.06	1.06	1.06	1.06	1.08
1800	1.32	1.29	1.23	1.04	1.11	1.06	1.06	1.06	1.06	1.09
1900	1.31	1.28	1.22	1.02	1.10	1.07	1.07	1.07	1.07	1.09
2000	1.32	1.26	1.20	1.02	1.08	1.07	1.07	1.07	1.07	1.10
2200	1.36	1.26	1.17	1.04	1.05	1.08	1.07	1.07	1.07	1.12
2400	1.42	1.28	1.17	1.08	1.04	1.10	1.08	1.08	1.08	1.13
2600	1.50	1.32	1.18	1.11	1.05	1.11	1.09	1.09	1.09	1.13
2800	1.53	1.35	1.20	1.13	1.07	1.11	1.09	1.09	1.09	1.14
3000	1.52	1.36	1.22	1.16	1.09	1.13	1.10	1.10	1.10	1.15
3200	1.45	1.34	1.23	1.18	1.11	1.13	1.11	1.11	1.11	1.15
3400	1.34	1.31	1.22	1.19	1.12	1.14	1.12	1.12	1.12	1.16
3600	1.23	1.28	1.22	1.20	1.14	1.15	1.12	1.12	1.12	1.16
3800	1.14	1.24	1.22	1.20	1.15	1.15	1.13	1.13	1.13	1.16
4000	1.10	1.20	1.22	1.18	1.15	1.15	1.12	1.12	1.12	1.15
4200	1.11	1.15	1.22	1.16	1.15	1.14	1.12	1.12	1.12	1.14
4400	1.13	1.09	1.20	1.14	1.14	1.13	1.11	1.11	1.11	1.13
4600	1.13	1.05	1.19	1.12	1.14	1.12	1.11	1.11	1.11	1.13
4800	1.11	1.08	1.18	1.09	1.16	1.12	1.10	1.10	1.10	1.12
5000	1.14	1.17	1.19	1.07	1.17	1.10	1.09	1.09	1.09	1.09
5200	1.19	1.25	1.22	1.08	1.18	1.08	1.07	1.07	1.07	1.07
5400	1.24	1.31	1.24	1.09	1.20	1.07	1.07	1.07	1.07	1.04
5600	1.28	1.34	1.25	1.10	1.21	1.06	1.07	1.07	1.07	1.03
5800	1.30	1.34	1.25	1.11	1.23	1.08	1.10	1.10	1.10	1.04
6000	1.27	1.27	1.19	1.09	1.24	1.11	1.14	1.14	1.14	1.09
6200	1.19	1.17	1.10	1.04	1.22	1.12	1.16	1.16	1.16	1.11
6300	1.16	1.15	1.07	1.04	1.21	1.12	1.17	1.17	1.17	1.13
6400	1.14	1.13	1.04	1.06	1.21	1.14	1.19	1.19	1.19	1.14
6500	1.14	1.15	1.05	1.09	1.22	1.16	1.21	1.21	1.21	1.17
6600	1.20	1.21	1.10	1.13	1.22	1.18	1.24	1.24	1.24	1.19
6700	1.30	1.31	1.17	1.19	1.23	1.21	1.27	1.27	1.27	1.23
6800	1.42	1.42	1.25	1.25	1.23	1.24	1.30	1.30	1.30	1.26
6900	1.55	1.54	1.33	1.31	1.23	1.26	1.32	1.33	1.33	1.29
7000	1.65	1.64	1.40	1.36	1.23	1.28	1.34	1.34	1.34	1.31
7100	1.73	1.71	1.46	1.40	1.22	1.29	1.35	1.35	1.35	1.33
7200	1.78	1.76	1.49	1.43	1.22	1.30	1.36	1.36	1.36	1.34
7300	1.81	1.80	1.53	1.46	1.22	1.32	1.38	1.38	1.38	1.36
7400	1.84	1.83	1.56	1.49	1.22	1.34	1.39	1.40	1.40	1.39
7500	1.85	1.84	1.58	1.52	1.23	1.36	1.42	1.42	1.42	1.42
7600	1.84	1.83	1.59	1.54	1.24	1.39	1.45	1.45	1.45	1.45
7700	1.80	1.79	1.58	1.55	1.24	1.42	1.47	1.47	1.47	1.48
7800	1.74	1.73	1.55	1.55	1.24	1.44	1.49	1.48	1.48	1.51
7900	1.65	1.63	1.51	1.53	1.24	1.45	1.49	1.49	1.49	1.53
8000	1.55	1.52	1.44	1.50	1.22	1.46	1.49	1.49	1.49	1.53

**Notes**

- A. Performance and quality attributes and conditions not expressly stated in this specification document are intended to be excluded and do not form a part of this specification document.
- B. Electrical specifications and performance data contained in this specification document are based on Mini-Circuit's applicable established test performance criteria and measurement instructions.
- C. The parts covered by this specification document are subject to Mini-Circuit's standard limited warranty and terms and conditions (collectively, "Standard Terms"). Purchasers of this part are entitled to the rights and benefits contained therein. For a full statement of the Standard Terms and the exclusive rights and remedies thereunder, please visit Mini-Circuit's website at [www.minicircuits.com/MC1Store/terms.jsp](http://www.minicircuits.com/MC1Store/terms.jsp)



# Programmable Attenuator RC4DAT-8G-120H

## Typical Performance Data @ 0°C

FREQUENCY (MHz)	Cross-Over Isolation (dB)									
	In1-In2	In2-In3	In3-In4	Out1- Out2	Out2- Out3	Out3- Out4	In1- Out2	Out1- In2	In3- Out4	Out3- In4
100	145.31	150.75	144.73	149.90	146.55	147.39	152.62	148.59	143.34	144.94
200	148.32	151.23	145.70	150.19	145.22	149.12	152.04	147.74	147.03	148.24
300	146.68	151.95	145.14	149.83	145.84	147.69	150.01	149.62	144.31	145.78
400	143.80	151.28	144.59	149.68	145.87	148.30	151.28	148.70	143.88	146.14
500	144.57	149.79	144.85	148.91	147.52	148.06	151.12	147.77	146.06	148.21
600	145.56	150.62	145.98	150.58	145.28	145.02	151.50	148.15	146.31	146.40
700	144.98	149.40	144.74	149.83	147.01	145.78	150.29	146.82	144.49	145.73
800	144.45	150.38	144.52	147.92	145.63	146.86	151.68	146.59	145.34	145.28
900	147.49	151.61	144.42	148.16	150.01	148.09	149.56	146.63	147.06	146.55
1000	148.23	152.54	144.84	149.59	148.18	147.85	150.12	149.16	145.45	145.36
1100	144.79	149.58	144.76	148.01	147.93	146.24	151.11	147.54	144.85	146.47
1200	147.85	148.70	144.30	148.29	147.27	148.05	148.08	145.84	145.23	145.42
1300	145.86	149.03	144.65	150.74	145.66	148.16	150.14	144.76	144.62	145.41
1400	145.64	150.50	147.48	148.00	144.10	145.96	151.41	146.27	144.95	145.78
1500	144.12	151.78	146.61	151.84	145.11	145.96	149.23	147.28	147.27	144.32
1600	146.12	149.38	143.95	148.83	145.40	146.39	150.70	147.32	144.90	145.55
1700	145.58	149.24	146.99	149.61	142.63	147.16	151.51	147.57	146.26	149.13
1800	144.21	151.60	144.44	149.19	143.88	144.23	149.77	147.38	145.23	145.52
1900	146.53	150.03	146.17	149.56	145.16	144.60	148.09	145.55	143.78	145.84
2000	144.69	148.90	145.98	149.73	144.45	146.47	149.45	145.91	143.75	145.88
2200	138.73	150.90	142.48	148.01	144.17	145.43	141.36	148.38	145.56	145.19
2400	141.55	147.93	144.37	150.67	147.01	147.09	148.13	146.37	146.59	145.61
2600	145.77	146.12	142.20	147.06	145.93	147.82	148.03	141.75	142.31	141.77
2800	143.11	131.38	141.47	149.01	144.62	146.88	149.12	140.39	143.92	147.10
3000	148.66	144.07	144.53	149.93	147.63	146.94	150.61	149.23	147.26	146.82
3200	145.17	146.09	144.95	147.99	144.64	145.45	150.88	148.92	145.84	145.89
3400	141.42	140.04	144.41	143.41	143.37	146.89	145.77	140.52	147.83	146.12
3600	145.56	147.33	144.62	145.97	145.69	146.10	149.20	145.85	145.29	145.72
3800	145.76	150.02	144.55	148.70	145.80	147.32	151.84	146.37	145.76	144.92
4000	145.48	148.04	143.04	148.35	145.16	147.64	149.88	147.66	146.32	145.16
4200	147.43	149.13	143.65	147.06	145.35	147.88	147.40	149.29	144.96	144.92
4400	144.16	147.44	146.89	146.82	144.07	146.29	147.85	145.97	147.43	145.97
4600	144.21	146.25	145.29	145.54	145.26	144.55	144.25	146.28	146.74	143.85
4800	145.65	147.24	145.10	147.49	145.82	143.96	146.35	146.35	145.34	144.15
5000	145.89	148.86	145.03	146.68	142.98	145.35	150.49	146.92	144.27	145.86
5200	144.63	147.76	143.30	148.49	142.66	146.50	148.63	147.00	144.94	144.75
5400	137.99	145.65	140.15	142.14	142.01	143.56	146.95	146.02	143.66	145.42
5600	141.91	147.13	144.43	145.51	143.37	143.14	146.06	144.84	143.91	145.14
5800	138.24	141.44	141.01	141.13	144.38	143.51	143.71	145.98	144.23	144.53
6000	139.30	143.64	134.25	140.82	140.69	145.97	143.05	142.65	139.43	136.95
6200	139.52	141.40	141.58	136.94	139.61	142.22	140.26	141.69	141.20	144.43
6300	141.80	144.26	140.00	139.76	142.71	145.78	145.48	143.35	141.15	145.08
6400	140.71	144.41	141.92	142.52	144.01	143.09	145.20	146.24	143.57	143.21
6500	141.91	146.98	139.04	140.67	143.09	144.94	145.44	145.89	144.72	143.31
6600	143.84	147.98	140.60	135.53	140.67	142.37	141.59	142.73	142.60	142.39
6700	140.03	146.97	140.38	131.67	138.49	144.74	138.88	138.36	143.09	144.62
6800	140.40	145.03	144.05	132.02	141.23	142.21	140.65	141.23	143.18	143.35
6900	139.34	145.22	139.39	131.71	137.82	144.54	139.78	142.96	140.98	142.67
7000	137.58	141.35	140.56	134.24	139.27	141.38	140.42	141.70	140.18	140.40
7100	140.44	139.76	142.01	135.25	139.78	141.75	143.24	140.82	142.94	141.49
7200	139.50	142.40	139.18	136.24	138.05	143.36	144.21	145.76	141.11	142.94
7300	137.63	145.35	140.50	140.12	134.59	142.96	140.79	146.57	142.84	142.19
7400	142.53	144.45	141.19	140.11	134.39	142.34	140.60	144.66	144.40	142.11
7500	144.45	144.33	138.94	142.13	133.22	143.76	138.39	142.37	144.54	141.96
7600	143.64	145.39	138.24	136.99	134.65	142.30	133.72	140.04	140.17	142.21
7700	138.32	142.21	138.73	132.95	137.18	140.38	132.01	137.35	138.04	140.14
7800	132.51	139.78	136.13	132.17	135.15	140.10	131.32	133.04	136.42	140.36
7900	128.45	140.08	133.97	127.75	135.84	141.49	130.34	130.08	135.88	140.81
8000	125.44	140.08	133.97	124.11	134.98	139.62	127.92	129.31	135.61	139.31

**Notes**

- A. Performance and quality attributes and conditions not expressly stated in this specification document are intended to be excluded and do not form a part of this specification document.
- B. Electrical specifications and performance data contained in this specification document are based on Mini-Circuits' applicable established test performance criteria and measurement instructions.
- C. The parts covered by this specification document are subject to Mini-Circuits' standard limited warranty and terms and conditions (collectively, "Standard Terms"). Purchasers of this part are entitled to the rights and benefits contained therein. For a full statement of the Standard Terms and the exclusive rights and remedies thereunder, please visit Mini-Circuits' website at [www.minicircuits.com/ACL/Store/terms.jsp](http://www.minicircuits.com/ACL/Store/terms.jsp)





# Programmable Attenuator RC4DAT-8G-120H

## Typical Performance Data @ 0°C

FREQUENCY (MHz)	I. Loss (dB)
100	4.26
200	4.23
300	4.30
400	4.41
500	4.55
600	4.69
700	4.83
800	4.97
900	5.09
1000	5.20
1100	5.27
1200	5.32
1300	5.38
1400	5.49
1500	5.61
1600	5.66
1700	5.67
1800	5.70
1900	5.74
2000	5.79
2200	5.90
2400	6.02
2600	6.22
2800	6.48
3000	6.73
3200	6.94
3400	7.13
3600	7.31
3800	7.47
4000	7.65
4200	7.83
4400	8.04
4600	8.27
4800	8.53
5000	8.78
5200	9.02
5400	9.25
5600	9.49
5800	9.74
6000	10.05
6200	10.40
6300	10.59
6400	10.80
6500	11.05
6600	11.35
6700	11.64
6800	11.87
6900	12.04
7000	12.16
7100	12.27
7200	12.38
7300	12.49
7400	12.59
7500	12.67
7600	12.74
7700	12.81
7800	12.90
7900	13.00
8000	13.10

FREQUENCY (MHz)	IP3 (dBm)
1	22.90
10	33.88
50	43.83
100	48.23
200	50.73
500	52.73
1000	55.39
1500	51.49
2000	51.77
2500	53.32
3000	52.44
3500	54.17
4000	52.76
4500	52.45
5000	53.30
5500	50.67
6000	49.41
6500	50.29
7000	48.72
7500	48.34
8000	47.83

**Notes**

- A. Performance and quality attributes and conditions not expressly stated in this specification document are intended to be excluded and do not form a part of this specification document.
- B. Electrical specifications and performance data contained in this specification document are based on Mini-Circuit's applicable established test performance criteria and measurement instructions.
- C. The parts covered by this specification document are subject to Mini-Circuits standard limited warranty and terms and conditions (collectively, "Standard Terms"); Purchasers of this part are entitled to the rights and benefits contained therein. For a full statement of the Standard Terms and the exclusive rights and remedies thereunder, please visit Mini-Circuits' website at [www.minicircuits.com/MC1Store/terms.jsp](http://www.minicircuits.com/MC1Store/terms.jsp)

REV. OR  
RC4DAT-8G-120H  
201015  
Page 6 of 18



# Programmable Attenuator RC4DAT-8G-120H

## Typical Performance Data @ 25°C

FREQUENCY (MHz)	Attenuation relative to Insertion Loss (dB)									
	1 dB	5 dB	10 dB	20 dB	40 dB	60 dB	80 dB	100 dB	110 dB	120 dB
100	1.06	5.12	10.17	20.17	40.11	59.74	79.46	99.21	108.11	116.28
200	1.06	5.12	10.17	20.20	40.13	59.77	79.47	99.12	107.98	116.15
300	1.06	5.09	10.14	20.19	40.01	59.67	79.08	98.35	107.17	115.32
400	1.05	5.06	10.09	20.16	39.88	59.53	78.76	97.77	106.59	114.75
500	1.03	5.01	10.04	20.11	39.77	59.45	78.57	97.54	106.40	114.72
600	1.02	4.96	9.98	20.05	39.68	59.36	78.52	97.56	106.49	114.87
700	1.01	4.91	9.93	19.99	39.61	59.31	78.52	97.69	106.69	115.07
800	1.00	4.86	9.89	19.93	39.55	59.28	78.53	97.85	106.90	115.36
900	0.99	4.83	9.87	19.90	39.52	59.28	78.58	98.00	107.09	115.70
1000	0.99	4.81	9.88	19.89	39.53	59.31	78.65	98.16	107.29	115.84
1100	0.99	4.82	9.91	19.91	39.55	59.37	78.75	98.29	107.43	116.08
1200	0.99	4.83	9.96	19.94	39.60	59.43	78.88	98.42	107.61	116.35
1300	1.00	4.85	10.01	19.98	39.66	59.52	79.01	98.59	107.78	116.59
1400	1.00	4.87	10.06	20.02	39.72	59.59	79.12	98.72	107.93	116.74
1500	1.00	4.89	10.09	20.05	39.76	59.66	79.17	98.83	108.05	116.88
1600	1.00	4.90	10.10	20.06	39.78	59.68	79.23	98.92	108.16	117.04
1700	1.00	4.90	10.11	20.06	39.79	59.72	79.26	98.99	108.27	117.16
1800	0.99	4.90	10.11	20.05	39.79	59.72	79.31	99.05	108.36	117.31
1900	0.99	4.90	10.12	20.05	39.80	59.76	79.34	99.14	108.44	117.43
2000	0.99	4.92	10.13	20.06	39.82	59.79	79.36	99.21	108.53	117.51
2200	1.00	4.97	10.19	20.12	39.89	59.87	79.51	99.37	108.76	117.78
2400	1.02	5.03	10.26	20.20	39.98	59.96	79.64	99.55	108.94	118.23
2600	1.04	5.07	10.28	20.23	40.02	60.00	79.72	99.66	109.08	118.36
2800	1.04	5.07	10.23	20.21	40.00	59.98	79.70	99.75	109.24	118.52
3000	1.04	5.05	10.16	20.17	39.96	59.94	79.71	99.86	109.41	118.98
3200	1.04	5.04	10.10	20.15	39.95	59.91	79.73	99.99	109.57	119.22
3400	1.04	5.06	10.07	20.16	39.99	59.94	79.83	100.15	109.79	119.55
3600	1.05	5.10	10.08	20.21	40.06	60.01	79.90	100.28	110.00	119.82
3800	1.05	5.14	10.10	20.27	40.15	60.06	80.05	100.50	110.25	120.36
4000	1.05	5.18	10.13	20.32	40.24	60.10	80.10	100.64	110.38	120.41
4200	1.05	5.21	10.16	20.35	40.32	60.13	80.20	100.81	110.60	120.99
4400	1.04	5.21	10.17	20.37	40.38	60.14	80.29	100.99	110.81	121.04
4600	1.03	5.21	10.17	20.37	40.41	60.20	80.31	101.04	110.90	121.58
4800	1.02	5.19	10.15	20.36	40.43	60.12	80.33	101.14	111.07	121.55
5000	1.01	5.18	10.12	20.35	40.43	60.11	80.33	101.23	111.15	122.05
5200	1.00	5.18	10.10	20.36	40.45	60.12	80.30	101.24	111.21	121.95
5400	1.01	5.19	10.10	20.40	40.48	60.16	80.36	101.33	111.28	122.19
5600	1.01	5.19	10.09	20.44	40.51	60.19	80.45	101.37	111.34	122.86
5800	1.01	5.17	10.09	20.46	40.50	60.25	80.46	101.38	111.41	122.46
6000	1.01	5.13	10.07	20.44	40.45	60.29	80.58	101.34	111.44	122.65
6200	1.00	5.08	10.06	20.38	40.36	60.23	80.63	101.24	111.26	122.74
6300	0.99	5.05	10.05	20.33	40.30	60.17	80.53	101.24	111.33	122.91
6400	0.98	5.03	10.05	20.28	40.23	60.20	80.46	101.18	111.28	123.08
6500	0.97	5.00	10.04	20.21	40.14	60.16	80.40	101.12	111.28	122.34
6600	0.96	4.98	10.04	20.14	40.05	60.07	80.26	100.93	111.04	122.67
6700	0.95	4.96	10.03	20.06	39.95	59.97	80.24	100.85	110.94	122.31
6800	0.95	4.95	10.04	19.99	39.85	59.90	80.15	100.58	110.69	121.91
6900	0.95	4.95	10.05	19.93	39.77	59.83	80.09	100.47	110.45	121.78
7000	0.96	4.96	10.07	19.90	39.70	59.72	79.99	100.36	110.40	121.48
7100	0.96	4.99	10.11	19.89	39.66	59.76	79.92	100.27	110.28	121.18
7200	0.98	5.03	10.16	19.92	39.64	59.73	79.85	100.16	110.09	120.91
7300	1.00	5.07	10.22	19.96	39.65	59.74	79.90	100.09	109.98	121.28
7400	1.02	5.12	10.28	20.02	39.67	59.74	79.73	99.98	109.86	121.01
7500	1.03	5.16	10.33	20.09	39.69	59.72	79.83	99.88	109.71	120.51
7600	1.04	5.19	10.37	20.15	39.70	59.78	79.86	99.77	109.53	120.50
7700	1.05	5.20	10.38	20.19	39.70	59.70	79.67	99.49	108.91	120.44
7800	1.05	5.19	10.38	20.23	39.68	59.69	79.55	99.42	109.01	119.66
7900	1.05	5.17	10.36	20.25	39.65	59.63	79.48	99.21	108.71	118.93
8000	1.04	5.15	10.34	20.27	39.63	59.55	79.35	99.07	108.56	118.30

**Notes**

- A. Performance and quality attributes and conditions not expressly stated in this specification document are intended to be excluded and do not form a part of this specification document.
- B. Electrical specifications and performance data contained in this specification document are based on Mini-Circuits' applicable established test performance criteria and measurement instructions.
- C. The parts covered by this specification document are subject to Mini-Circuits' standard limited warranty and terms and conditions (collectively, "Standard Terms"); Purchasers of this part are entitled to the rights and benefits contained therein. For a full statement of the Standard Terms and the exclusive rights and remedies thereunder, please visit Mini-Circuits' website at [www.minicircuits.com/MC1Store/terms.jsp](http://www.minicircuits.com/MC1Store/terms.jsp)



# Programmable Attenuator RC4DAT-8G-120H

## Typical Performance Data @ 25°C

FREQUENCY (MHz)	Attenuation accuracy relative to nominal attenuation setting (dB)									
	1 dB	5 dB	10 dB	20 dB	40 dB	60 dB	80 dB	100 dB	110 dB	120 dB
100	-0.06	-0.12	-0.17	-0.17	-0.11	0.26	0.54	0.79	1.89	3.72
200	-0.06	-0.12	-0.17	-0.20	-0.13	0.23	0.53	0.88	2.02	3.85
300	-0.06	-0.09	-0.14	-0.19	-0.01	0.33	0.92	1.65	2.83	4.68
400	-0.05	-0.06	-0.09	-0.16	0.12	0.47	1.24	2.23	3.41	5.25
500	-0.03	-0.01	-0.04	-0.11	0.23	0.55	1.43	2.46	3.60	5.28
600	-0.02	0.04	0.02	-0.05	0.32	0.64	1.48	2.44	3.51	5.13
700	-0.01	0.09	0.07	0.01	0.39	0.69	1.48	2.31	3.31	4.93
800	0.00	0.14	0.11	0.07	0.45	0.72	1.47	2.15	3.10	4.64
900	0.01	0.17	0.13	0.10	0.48	0.72	1.42	2.00	2.91	4.30
1000	0.01	0.19	0.12	0.11	0.47	0.69	1.35	1.84	2.71	4.16
1100	0.01	0.18	0.09	0.09	0.45	0.63	1.25	1.71	2.57	3.92
1200	0.01	0.17	0.04	0.06	0.40	0.57	1.12	1.58	2.39	3.65
1300	0.00	0.15	-0.01	0.02	0.34	0.48	0.99	1.41	2.22	3.41
1400	0.00	0.13	-0.06	-0.02	0.28	0.41	0.88	1.28	2.07	3.26
1500	0.00	0.11	-0.09	-0.05	0.24	0.34	0.83	1.17	1.95	3.12
1600	0.00	0.10	-0.10	-0.06	0.22	0.32	0.77	1.08	1.84	2.96
1700	0.00	0.10	-0.11	-0.06	0.21	0.28	0.74	1.01	1.73	2.84
1800	0.01	0.10	-0.11	-0.05	0.21	0.28	0.69	0.95	1.64	2.69
1900	0.01	0.10	-0.12	-0.05	0.20	0.24	0.66	0.86	1.56	2.57
2000	0.01	0.08	-0.13	-0.06	0.18	0.21	0.64	0.79	1.47	2.49
2200	0.00	0.03	-0.19	-0.12	0.11	0.13	0.49	0.63	1.24	2.22
2400	-0.02	-0.03	-0.26	-0.20	0.02	0.04	0.36	0.45	1.06	1.77
2600	-0.04	-0.07	-0.28	-0.23	-0.02	0.00	0.28	0.34	0.92	1.64
2800	-0.04	-0.07	-0.23	-0.21	0.00	0.02	0.30	0.25	0.76	1.48
3000	-0.04	-0.05	-0.16	-0.17	0.04	0.06	0.29	0.14	0.59	1.02
3200	-0.04	-0.04	-0.10	-0.15	0.05	0.09	0.27	0.01	0.43	0.78
3400	-0.04	-0.06	-0.07	-0.16	0.01	0.06	0.17	-0.15	0.21	0.45
3600	-0.05	-0.10	-0.08	-0.21	-0.06	-0.01	0.10	-0.28	0.00	0.18
3800	-0.05	-0.14	-0.10	-0.27	-0.15	-0.06	-0.05	-0.50	-0.25	-0.36
4000	-0.05	-0.18	-0.13	-0.32	-0.24	-0.10	-0.10	-0.64	-0.38	-0.41
4200	-0.05	-0.21	-0.16	-0.35	-0.32	-0.13	-0.20	-0.81	-0.60	-0.99
4400	-0.04	-0.21	-0.17	-0.37	-0.38	-0.14	-0.29	-0.99	-0.81	-1.04
4600	-0.03	-0.21	-0.17	-0.37	-0.41	-0.20	-0.31	-1.04	-0.90	-1.58
4800	-0.02	-0.19	-0.15	-0.36	-0.43	-0.12	-0.33	-1.14	-1.07	-1.55
5000	-0.01	-0.18	-0.12	-0.35	-0.43	-0.11	-0.33	-1.23	-1.15	-2.05
5200	0.00	-0.18	-0.10	-0.36	-0.45	-0.12	-0.30	-1.24	-1.21	-1.95
5400	-0.01	-0.19	-0.10	-0.40	-0.48	-0.16	-0.36	-1.33	-1.28	-2.19
5600	-0.01	-0.19	-0.09	-0.44	-0.51	-0.19	-0.45	-1.37	-1.34	-2.86
5800	-0.01	-0.17	-0.09	-0.46	-0.50	-0.25	-0.46	-1.38	-1.41	-2.46
6000	-0.01	-0.13	-0.07	-0.44	-0.45	-0.29	-0.58	-1.34	-1.44	-2.65
6200	0.00	-0.08	-0.06	-0.38	-0.36	-0.23	-0.63	-1.24	-1.26	-2.74
6300	0.01	-0.05	-0.05	-0.33	-0.30	-0.17	-0.53	-1.24	-1.33	-2.91
6400	0.02	-0.03	-0.05	-0.28	-0.23	-0.20	-0.46	-1.18	-1.28	-3.08
6500	0.03	0.00	-0.04	-0.21	-0.14	-0.16	-0.40	-1.12	-1.28	-2.34
6600	0.04	0.02	-0.04	-0.14	-0.05	-0.07	-0.26	-0.93	-1.04	-2.67
6700	0.05	0.04	-0.03	-0.06	0.05	0.03	-0.24	-0.85	-0.94	-2.31
6800	0.05	0.05	-0.04	0.01	0.15	0.10	-0.15	-0.58	-0.69	-1.91
6900	0.05	0.05	-0.05	0.07	0.23	0.17	-0.09	-0.47	-0.45	-1.78
7000	0.04	0.04	-0.07	0.10	0.30	0.28	0.01	-0.36	-0.40	-1.48
7100	0.04	0.01	-0.11	0.11	0.34	0.24	0.08	-0.27	-0.28	-1.18
7200	0.02	-0.03	-0.16	0.08	0.36	0.27	0.15	-0.16	-0.09	-0.91
7300	0.00	-0.07	-0.22	0.04	0.35	0.26	0.10	-0.09	0.02	-1.28
7400	-0.02	-0.12	-0.28	-0.02	0.33	0.26	0.27	0.02	0.14	-1.01
7500	-0.03	-0.16	-0.33	-0.09	0.31	0.28	0.17	0.12	0.29	-0.51
7600	-0.04	-0.19	-0.37	-0.15	0.30	0.22	0.14	0.23	0.47	-0.50
7700	-0.05	-0.20	-0.38	-0.19	0.30	0.30	0.33	0.51	1.09	-0.44
7800	-0.05	-0.19	-0.38	-0.23	0.32	0.31	0.45	0.58	0.99	0.34
7900	-0.05	-0.17	-0.36	-0.25	0.35	0.37	0.52	0.79	1.29	1.07
8000	-0.04	-0.15	-0.34	-0.27	0.37	0.45	0.65	0.93	1.44	1.70

**Notes**

- A. Performance and quality attributes and conditions not expressly stated in this specification document are intended to be excluded and do not form a part of this specification document.
- B. Electrical specifications and performance data contained in this specification document are based on Mini-Circuits' applicable established test performance criteria and measurement instructions.
- C. The parts covered by this specification document are subject to Mini-Circuits' standard limited warranty and terms and conditions (collectively, "Standard Terms"). Purchasers of this part are entitled to the rights and benefits contained therein. For a full statement of the Standard Terms and the exclusive rights and remedies thereunder, please visit Mini-Circuits' website at [www.minicircuits.com/ACL/Store/terms.jsp](http://www.minicircuits.com/ACL/Store/terms.jsp)



# Programmable Attenuator RC4DAT-8G-120H

## Typical Performance Data @ 25°C

FREQUENCY (MHz)	Input VSWR (:1)									
	1 dB	5 dB	10 dB	20 dB	40 dB	60 dB	80 dB	100 dB	110 dB	120 dB
100	1.66	1.47	1.21	1.33	1.15	1.13	1.13	1.14	1.13	1.13
200	1.50	1.38	1.13	1.29	1.07	1.06	1.04	1.07	1.06	1.06
300	1.42	1.34	1.10	1.28	1.06	1.04	1.02	1.05	1.05	1.05
400	1.34	1.31	1.09	1.27	1.06	1.05	1.02	1.05	1.05	1.05
500	1.26	1.27	1.07	1.27	1.06	1.06	1.04	1.06	1.06	1.06
600	1.19	1.25	1.06	1.26	1.07	1.07	1.05	1.06	1.07	1.07
700	1.15	1.23	1.05	1.25	1.07	1.08	1.06	1.06	1.09	1.09
800	1.15	1.23	1.04	1.25	1.08	1.10	1.08	1.07	1.10	1.10
900	1.20	1.24	1.05	1.24	1.08	1.11	1.09	1.07	1.11	1.11
1000	1.25	1.26	1.05	1.24	1.08	1.12	1.09	1.07	1.12	1.12
1100	1.29	1.27	1.06	1.23	1.08	1.12	1.10	1.08	1.13	1.13
1200	1.32	1.28	1.06	1.22	1.08	1.13	1.11	1.08	1.14	1.14
1300	1.32	1.27	1.06	1.21	1.08	1.14	1.12	1.08	1.15	1.15
1400	1.31	1.26	1.06	1.20	1.08	1.15	1.12	1.08	1.15	1.15
1500	1.28	1.24	1.06	1.19	1.07	1.15	1.13	1.08	1.15	1.15
1600	1.24	1.22	1.05	1.18	1.07	1.15	1.13	1.07	1.16	1.16
1700	1.19	1.19	1.05	1.17	1.06	1.15	1.13	1.07	1.16	1.16
1800	1.14	1.16	1.06	1.15	1.05	1.16	1.13	1.07	1.17	1.17
1900	1.09	1.13	1.06	1.14	1.05	1.16	1.14	1.07	1.17	1.17
2000	1.06	1.12	1.06	1.13	1.05	1.17	1.14	1.07	1.17	1.17
2200	1.09	1.12	1.06	1.12	1.05	1.17	1.14	1.07	1.18	1.18
2400	1.15	1.15	1.06	1.12	1.05	1.17	1.14	1.06	1.17	1.17
2600	1.20	1.17	1.06	1.13	1.06	1.17	1.14	1.06	1.17	1.17
2800	1.23	1.20	1.07	1.14	1.06	1.16	1.13	1.06	1.16	1.16
3000	1.23	1.21	1.08	1.16	1.07	1.14	1.12	1.06	1.15	1.15
3200	1.24	1.22	1.09	1.17	1.07	1.13	1.11	1.07	1.14	1.14
3400	1.26	1.23	1.11	1.18	1.08	1.12	1.09	1.07	1.12	1.12
3600	1.29	1.24	1.12	1.18	1.07	1.10	1.07	1.07	1.10	1.10
3800	1.30	1.24	1.12	1.18	1.06	1.08	1.06	1.06	1.09	1.09
4000	1.26	1.21	1.10	1.18	1.06	1.06	1.04	1.06	1.07	1.07
4200	1.17	1.17	1.06	1.18	1.05	1.05	1.03	1.05	1.05	1.05
4400	1.07	1.13	1.03	1.18	1.05	1.05	1.04	1.04	1.05	1.05
4600	1.06	1.12	1.04	1.17	1.05	1.06	1.07	1.04	1.06	1.06
4800	1.16	1.14	1.07	1.17	1.06	1.08	1.10	1.05	1.09	1.09
5000	1.24	1.16	1.10	1.17	1.07	1.11	1.13	1.07	1.12	1.12
5200	1.28	1.16	1.11	1.16	1.09	1.15	1.17	1.09	1.16	1.16
5400	1.25	1.13	1.11	1.15	1.11	1.19	1.21	1.12	1.19	1.19
5600	1.17	1.06	1.12	1.13	1.14	1.23	1.25	1.16	1.24	1.24
5800	1.10	1.03	1.17	1.12	1.17	1.28	1.30	1.20	1.29	1.29
6000	1.18	1.14	1.24	1.13	1.22	1.33	1.35	1.24	1.33	1.33
6200	1.33	1.26	1.33	1.16	1.27	1.38	1.40	1.28	1.38	1.38
6300	1.41	1.33	1.39	1.19	1.30	1.41	1.43	1.31	1.41	1.41
6400	1.48	1.39	1.44	1.21	1.33	1.43	1.45	1.33	1.43	1.43
6500	1.55	1.44	1.49	1.23	1.36	1.46	1.47	1.35	1.46	1.46
6600	1.62	1.49	1.54	1.26	1.39	1.48	1.49	1.38	1.48	1.48
6700	1.67	1.54	1.59	1.28	1.42	1.51	1.52	1.41	1.51	1.51
6800	1.71	1.57	1.62	1.30	1.45	1.53	1.54	1.43	1.54	1.54
6900	1.72	1.59	1.65	1.32	1.47	1.56	1.56	1.45	1.56	1.56
7000	1.70	1.59	1.66	1.33	1.49	1.57	1.57	1.47	1.57	1.57
7100	1.66	1.57	1.66	1.35	1.51	1.60	1.58	1.50	1.60	1.60
7200	1.59	1.54	1.65	1.36	1.53	1.61	1.60	1.52	1.62	1.62
7300	1.50	1.50	1.63	1.37	1.55	1.63	1.61	1.54	1.63	1.63
7400	1.41	1.46	1.61	1.38	1.57	1.65	1.62	1.56	1.65	1.65
7500	1.32	1.42	1.59	1.40	1.58	1.66	1.63	1.58	1.67	1.67
7600	1.26	1.39	1.57	1.41	1.60	1.68	1.63	1.60	1.68	1.68
7700	1.26	1.37	1.56	1.43	1.61	1.69	1.63	1.62	1.69	1.69
7800	1.31	1.38	1.56	1.45	1.62	1.70	1.63	1.64	1.70	1.70
7900	1.38	1.40	1.56	1.47	1.63	1.70	1.63	1.65	1.71	1.71
8000	1.46	1.43	1.57	1.49	1.64	1.70	1.62	1.66	1.71	1.71

**Notes**

- A. Performance and quality attributes and conditions not expressly stated in this specification document are intended to be excluded and do not form a part of this specification document.
- B. Electrical specifications and performance data contained in this specification document are based on Mini-Circuit's applicable established test performance criteria and measurement instructions.
- C. The parts covered by this specification document are subject to Mini-Circuit's standard limited warranty and terms and conditions (collectively, "Standard Terms"). Purchasers of this part are entitled to the rights and benefits contained therein. For a full statement of the Standard Terms and the exclusive rights and remedies thereunder, please visit Mini-Circuit's website at [www.minicircuits.com/MC1Store/terms.jsp](http://www.minicircuits.com/MC1Store/terms.jsp)



# Programmable Attenuator RC4DAT-8G-120H

## Typical Performance Data @ 25°C

FREQUENCY (MHz)	Output VSWR (:1)									
	1 dB	5 dB	10 dB	20 dB	40 dB	60 dB	80 dB	100 dB	110 dB	120 dB
100	1.69	1.41	1.30	1.17	1.26	1.14	1.16	1.15	1.15	1.13
200	1.53	1.28	1.23	1.09	1.22	1.08	1.08	1.08	1.08	1.05
300	1.43	1.23	1.21	1.07	1.22	1.06	1.07	1.07	1.07	1.03
400	1.34	1.21	1.20	1.06	1.22	1.06	1.07	1.07	1.07	1.03
500	1.24	1.19	1.19	1.07	1.22	1.06	1.07	1.07	1.07	1.03
600	1.14	1.18	1.19	1.07	1.21	1.06	1.08	1.08	1.08	1.03
700	1.05	1.19	1.20	1.08	1.21	1.06	1.08	1.08	1.08	1.04
800	1.07	1.22	1.21	1.08	1.21	1.06	1.08	1.08	1.08	1.05
900	1.15	1.26	1.23	1.09	1.20	1.06	1.08	1.08	1.08	1.05
1000	1.23	1.30	1.25	1.09	1.19	1.06	1.08	1.08	1.08	1.06
1100	1.30	1.33	1.27	1.09	1.18	1.06	1.08	1.08	1.08	1.06
1200	1.35	1.36	1.28	1.09	1.18	1.06	1.08	1.07	1.07	1.07
1300	1.38	1.37	1.29	1.09	1.17	1.06	1.07	1.07	1.07	1.07
1400	1.39	1.37	1.29	1.08	1.16	1.06	1.07	1.07	1.07	1.07
1500	1.38	1.36	1.29	1.08	1.15	1.06	1.07	1.07	1.07	1.07
1600	1.37	1.34	1.28	1.06	1.14	1.05	1.06	1.06	1.06	1.07
1700	1.35	1.33	1.26	1.05	1.13	1.05	1.06	1.06	1.06	1.07
1800	1.34	1.32	1.25	1.03	1.12	1.05	1.05	1.05	1.05	1.08
1900	1.34	1.30	1.24	1.02	1.11	1.05	1.05	1.05	1.05	1.08
2000	1.35	1.30	1.23	1.00	1.10	1.05	1.05	1.05	1.05	1.09
2200	1.40	1.31	1.21	1.03	1.08	1.06	1.05	1.05	1.05	1.09
2400	1.48	1.34	1.22	1.06	1.07	1.07	1.05	1.05	1.05	1.10
2600	1.55	1.37	1.23	1.10	1.08	1.08	1.06	1.06	1.06	1.11
2800	1.56	1.39	1.24	1.13	1.09	1.09	1.07	1.07	1.07	1.11
3000	1.52	1.38	1.25	1.15	1.10	1.10	1.08	1.08	1.08	1.12
3200	1.43	1.35	1.24	1.16	1.11	1.11	1.09	1.09	1.09	1.13
3400	1.31	1.30	1.22	1.17	1.13	1.12	1.10	1.09	1.09	1.13
3600	1.20	1.25	1.21	1.17	1.14	1.13	1.10	1.10	1.10	1.14
3800	1.11	1.21	1.20	1.17	1.14	1.13	1.11	1.11	1.11	1.14
4000	1.08	1.16	1.21	1.16	1.15	1.13	1.11	1.11	1.11	1.14
4200	1.11	1.12	1.21	1.15	1.15	1.13	1.11	1.11	1.10	1.13
4400	1.13	1.08	1.20	1.13	1.15	1.12	1.10	1.10	1.10	1.12
4600	1.12	1.05	1.18	1.10	1.15	1.11	1.09	1.09	1.09	1.11
4800	1.10	1.09	1.17	1.08	1.15	1.10	1.08	1.08	1.08	1.10
5000	1.13	1.16	1.19	1.06	1.16	1.08	1.07	1.07	1.07	1.08
5200	1.18	1.24	1.21	1.07	1.18	1.07	1.06	1.07	1.07	1.06
5400	1.24	1.30	1.24	1.08	1.19	1.06	1.06	1.06	1.06	1.04
5600	1.26	1.32	1.24	1.09	1.20	1.06	1.07	1.07	1.07	1.02
5800	1.27	1.30	1.22	1.09	1.21	1.06	1.09	1.09	1.09	1.04
6000	1.26	1.25	1.18	1.07	1.21	1.08	1.11	1.11	1.11	1.06
6200	1.20	1.18	1.11	1.04	1.21	1.10	1.15	1.15	1.15	1.10
6300	1.17	1.14	1.08	1.03	1.21	1.12	1.16	1.16	1.16	1.12
6400	1.15	1.13	1.05	1.05	1.20	1.13	1.18	1.18	1.18	1.14
6500	1.16	1.16	1.05	1.09	1.20	1.15	1.20	1.20	1.20	1.16
6600	1.21	1.22	1.10	1.12	1.20	1.16	1.22	1.22	1.22	1.18
6700	1.30	1.30	1.16	1.17	1.20	1.18	1.24	1.24	1.24	1.20
6800	1.40	1.39	1.22	1.21	1.20	1.20	1.26	1.26	1.26	1.22
6900	1.49	1.48	1.28	1.26	1.20	1.21	1.27	1.28	1.28	1.24
7000	1.59	1.57	1.35	1.31	1.20	1.23	1.29	1.29	1.29	1.26
7100	1.67	1.64	1.40	1.35	1.20	1.25	1.31	1.31	1.31	1.28
7200	1.73	1.71	1.45	1.39	1.21	1.27	1.33	1.33	1.33	1.31
7300	1.78	1.76	1.49	1.43	1.21	1.29	1.35	1.35	1.35	1.33
7400	1.81	1.79	1.53	1.46	1.22	1.31	1.37	1.37	1.37	1.36
7500	1.81	1.80	1.54	1.48	1.22	1.33	1.39	1.39	1.39	1.38
7600	1.80	1.79	1.55	1.50	1.22	1.35	1.41	1.40	1.41	1.41
7700	1.77	1.76	1.54	1.51	1.22	1.37	1.42	1.42	1.42	1.43
7800	1.73	1.71	1.53	1.51	1.22	1.39	1.44	1.44	1.44	1.45
7900	1.67	1.65	1.50	1.50	1.22	1.41	1.45	1.45	1.45	1.48
8000	1.59	1.56	1.46	1.49	1.22	1.43	1.46	1.47	1.47	1.50

**Notes**

- A. Performance and quality attributes and conditions not expressly stated in this specification document are intended to be excluded and do not form a part of this specification document.
- B. Electrical specifications and performance data contained in this specification document are based on Mini-Circuit's applicable established test performance criteria and measurement instructions.
- C. The parts covered by this specification document are subject to Mini-Circuit's standard limited warranty and terms and conditions (collectively, "Standard Terms"). Purchasers of this part are entitled to the rights and benefits contained therein. For a full statement of the Standard Terms and the exclusive rights and remedies thereunder, please visit Mini-Circuit's website at [www.minicircuits.com/AC1Store/terms.jsp](http://www.minicircuits.com/AC1Store/terms.jsp)



# Programmable Attenuator RC4DAT-8G-120H

## Typical Performance Data @ 25°C

FREQUENCY (MHz)	Cross-Over Isolation (dB)									
	In1-In2	In2-In3	In3-In4	Out1- Out2	Out2- Out3	Out3- Out4	In1- Out2	Out1- In2	In3- Out4	Out3- In4
100	150.49	150.87	147.16	150.87	151.22	146.30	150.88	152.08	150.81	147.76
200	151.71	151.13	150.41	150.08	150.22	149.42	148.84	150.26	153.91	152.15
300	150.10	151.73	152.40	148.83	151.77	151.10	151.58	151.79	154.63	149.74
400	148.89	151.85	150.34	151.83	150.00	150.93	151.45	152.46	156.69	149.68
500	148.89	151.25	150.63	150.59	150.42	148.91	152.26	151.77	155.94	150.25
600	151.03	151.24	150.76	150.16	150.20	149.78	152.76	151.22	155.24	152.58
700	150.67	150.63	149.70	151.10	149.90	149.76	153.10	150.89	153.70	148.00
800	150.76	151.19	150.38	152.24	150.54	150.00	151.80	150.89	151.93	149.43
900	149.58	149.95	152.59	152.32	150.06	149.88	151.79	151.30	148.44	150.58
1000	149.36	151.18	152.01	152.40	149.14	151.25	150.49	150.58	150.07	150.65
1100	149.79	151.21	152.05	149.76	149.55	150.80	149.89	150.87	154.85	150.45
1200	151.00	151.36	149.58	149.14	151.74	149.29	150.17	150.45	156.27	149.48
1300	150.47	151.36	149.74	149.79	152.12	148.73	150.78	151.30	156.55	148.73
1400	150.13	149.31	150.10	148.63	150.65	150.63	150.11	149.61	154.85	147.52
1500	151.19	148.88	153.14	151.88	150.73	150.72	150.39	151.20	155.14	148.96
1600	150.31	148.73	149.90	153.45	151.16	150.84	149.02	150.11	153.65	150.05
1700	149.58	150.71	150.07	153.02	151.63	150.41	149.80	150.99	153.71	148.16
1800	148.68	150.74	148.72	151.53	149.09	148.57	150.01	150.28	152.88	148.08
1900	150.82	151.68	149.35	149.27	151.63	149.97	149.03	149.70	152.94	149.53
2000	148.80	150.86	149.91	151.11	149.91	150.57	151.38	150.72	153.38	149.34
2200	141.16	149.45	140.96	149.89	150.21	148.63	142.14	151.88	148.98	148.02
2400	146.73	147.35	146.47	149.67	150.76	149.92	144.68	149.95	153.37	149.19
2600	145.73	144.29	145.71	150.69	149.31	146.86	147.50	144.29	146.33	143.55
2800	142.74	131.62	145.87	148.53	149.66	151.07	151.33	144.41	153.29	147.94
3000	151.30	142.69	151.00	151.25	150.35	152.09	151.20	150.73	154.31	149.18
3200	150.73	146.28	146.31	147.63	151.51	149.62	152.23	148.31	152.79	149.36
3400	146.67	139.85	147.87	145.71	150.71	150.69	148.58	141.51	154.28	149.39
3600	147.60	148.61	145.24	150.09	151.10	151.25	149.89	145.74	151.06	147.91
3800	149.45	147.82	147.29	149.07	148.64	147.05	151.22	149.27	152.57	148.49
4000	150.81	147.68	147.07	148.69	149.00	149.95	148.73	148.20	155.29	148.55
4200	148.43	147.91	149.06	148.76	150.08	149.90	147.73	148.56	154.38	147.33
4400	150.61	145.14	149.62	148.77	152.09	150.96	148.51	146.75	155.27	149.61
4600	147.67	150.52	150.57	147.49	147.87	148.98	147.03	149.06	154.33	150.51
4800	149.86	148.04	149.24	149.66	148.43	148.25	147.70	149.01	151.43	149.83
5000	149.66	151.25	150.60	148.70	150.23	151.75	151.35	149.76	151.70	148.94
5200	145.94	151.55	150.60	147.58	151.34	149.74	146.59	147.30	155.22	149.24
5400	143.48	150.56	148.13	147.83	150.52	150.54	146.00	146.78	155.75	146.66
5600	143.54	150.55	148.88	150.82	149.38	150.34	145.43	149.10	152.77	149.18
5800	144.43	144.85	149.38	148.60	148.22	140.34	145.88	147.78	150.61	144.22
6000	147.96	147.21	150.33	150.26	149.36	141.96	147.89	149.03	147.08	145.62
6200	150.48	150.16	147.94	148.93	149.07	147.96	148.61	148.72	152.26	148.45
6300	149.27	149.28	151.18	145.71	149.74	151.63	146.54	149.35	152.90	149.97
6400	148.11	150.39	149.73	142.33	149.06	150.41	146.76	147.33	152.38	151.73
6500	146.05	148.67	148.74	139.00	149.08	149.85	144.78	149.88	151.20	148.95
6600	142.51	148.06	150.56	136.45	148.16	150.82	143.89	142.80	153.76	148.81
6700	143.14	150.05	149.49	136.96	147.07	149.46	143.56	142.60	151.87	149.42
6800	143.09	149.02	149.55	136.27	145.08	147.27	145.49	145.43	153.14	150.23
6900	142.40	146.10	149.26	136.61	144.12	144.35	144.96	144.88	152.29	149.41
7000	141.21	144.80	147.00	137.96	144.99	142.46	144.99	146.09	151.79	147.58
7100	144.12	142.05	146.14	139.93	145.03	142.84	148.85	148.18	152.98	150.17
7200	146.64	144.01	144.11	141.20	147.59	142.64	145.97	146.49	152.73	147.92
7300	141.77	144.04	146.02	143.86	148.42	144.42	146.57	146.33	152.14	147.97
7400	141.60	146.55	145.56	145.69	148.45	146.79	144.15	149.20	152.26	147.12
7500	143.98	146.80	150.12	144.30	143.73	145.45	138.81	146.08	151.04	149.46
7600	145.28	146.54	146.25	140.10	142.19	143.55	136.20	140.92	146.65	146.75
7700	142.72	143.61	144.11	135.07	142.86	143.69	134.90	139.35	143.95	145.20
7800	139.64	143.02	143.58	131.30	142.15	143.32	132.81	136.40	144.58	145.17
7900	134.51	140.92	144.19	128.91	138.18	142.79	130.39	132.55	144.21	145.97
8000	127.98	141.19	145.24	126.78	136.77	142.44	129.03	132.04	145.90	147.49

**Notes**

- A. Performance and quality attributes and conditions not expressly stated in this specification document are intended to be excluded and do not form a part of this specification document.
- B. Electrical specifications and performance data contained in this specification document are based on Mini-Circuit's applicable established test performance criteria and measurement instructions.
- C. The parts covered by this specification document are subject to Mini-Circuit's standard limited warranty and terms and conditions (collectively, "Standard Terms"). Purchasers of this part are entitled to the rights and benefits contained therein. For a full statement of the Standard Terms and the exclusive rights and remedies thereunder, please visit Mini-Circuit's website at [www.minicircuits.com/ACL/Store/terms.jsp](http://www.minicircuits.com/ACL/Store/terms.jsp)



# Programmable Attenuator RC4DAT-8G-120H

## Typical Performance Data @ 25°C

FREQUENCY (MHz)	I. Loss (dB)
100	4.26
200	4.29
300	4.39
400	4.52
500	4.66
600	4.81
700	4.96
800	5.10
900	5.23
1000	5.34
1100	5.40
1200	5.45
1300	5.52
1400	5.63
1500	5.74
1600	5.79
1700	5.79
1800	5.82
1900	5.87
2000	5.93
2200	6.05
2400	6.17
2600	6.37
2800	6.62
3000	6.88
3200	7.11
3400	7.31
3600	7.48
3800	7.65
4000	7.82
4200	8.00
4400	8.22
4600	8.46
4800	8.71
5000	8.97
5200	9.22
5400	9.44
5600	9.67
5800	9.93
6000	10.23
6200	10.58
6300	10.77
6400	10.98
6500	11.20
6600	11.43
6700	11.66
6800	11.90
6900	12.12
7000	12.32
7100	12.50
7200	12.64
7300	12.76
7400	12.86
7500	12.95
7600	13.04
7700	13.14
7800	13.25
7900	13.36
8000	13.46

FREQUENCY (MHz)	IP3 (dBm)
1	23.63
10	33.93
50	44.26
100	48.17
200	50.41
500	52.77
1000	54.09
1500	51.70
2000	53.42
2500	54.99
3000	51.46
3500	52.91
4000	51.33
4500	51.72
5000	51.47
5500	49.28
6000	50.66
6500	49.73
7000	49.22
7500	50.22
8000	48.12

**Notes**

- A. Performance and quality attributes and conditions not expressly stated in this specification document are intended to be excluded and do not form a part of this specification document.
- B. Electrical specifications and performance data contained in this specification document are based on Mini-Circuits' applicable established test performance criteria and measurement instructions.
- C. The parts covered by this specification document are subject to Mini-Circuits' standard limited warranty and terms and conditions (collectively, "Standard Terms"); Purchasers of this part are entitled to the rights and benefits contained therein. For a full statement of the Standard Terms and the exclusive rights and remedies thereunder, please visit Mini-Circuits' website at [www.minicircuits.com/MC1Store/terms.jsp](http://www.minicircuits.com/MC1Store/terms.jsp)





# Programmable Attenuator RC4DAT-8G-120H

## Typical Performance Data @ 50°C

FREQUENCY (MHz)	Attenuation relative to Insertion Loss (dB)									
	1 dB	5 dB	10 dB	20 dB	40 dB	60 dB	80 dB	100 dB	110 dB	120 dB
100	1.05	5.08	10.15	20.09	39.97	59.56	79.20	98.86	107.77	115.90
200	1.05	5.08	10.14	20.12	39.99	59.57	79.20	98.77	107.60	115.82
300	1.04	5.05	10.10	20.10	39.87	59.45	78.87	97.98	106.83	115.01
400	1.03	5.01	10.05	20.06	39.73	59.31	78.39	97.42	106.21	114.37
500	1.02	4.97	9.99	20.01	39.62	59.23	78.44	97.18	105.99	114.25
600	1.01	4.92	9.93	19.96	39.53	59.19	78.16	97.19	106.09	114.42
700	1.00	4.87	9.88	19.90	39.46	59.11	78.13	97.32	106.28	114.79
800	0.99	4.83	9.85	19.85	39.41	59.08	78.77	97.46	106.46	114.96
900	0.98	4.80	9.84	19.82	39.39	59.07	78.58	97.63	106.64	115.21
1000	0.98	4.79	9.85	19.82	39.39	59.13	78.41	97.77	106.87	115.48
1100	0.98	4.80	9.87	19.83	39.42	59.14	78.77	97.91	107.00	115.61
1200	0.99	4.81	9.92	19.86	39.47	59.21	78.86	98.04	107.17	115.90
1300	0.99	4.84	9.98	19.91	39.52	59.29	78.72	98.16	107.32	116.17
1400	1.00	4.86	10.03	19.94	39.59	59.39	79.05	98.32	107.52	116.42
1500	1.00	4.88	10.06	19.97	39.63	59.47	78.76	98.43	107.61	116.42
1600	1.00	4.88	10.08	19.98	39.66	59.47	78.80	98.52	107.75	116.53
1700	0.99	4.88	10.09	19.97	39.67	59.51	79.01	98.60	107.84	116.70
1800	0.99	4.88	10.09	19.97	39.67	59.54	78.93	98.66	107.94	116.92
1900	0.98	4.88	10.10	19.97	39.68	59.58	79.38	98.75	108.05	117.07
2000	0.98	4.89	10.11	19.98	39.70	59.63	79.09	98.82	108.12	117.27
2200	0.99	4.94	10.17	20.04	39.79	59.70	79.28	98.99	108.32	117.46
2400	1.01	5.01	10.25	20.13	39.88	59.78	79.36	99.18	108.51	117.77
2600	1.03	5.05	10.27	20.17	39.92	59.86	79.45	99.31	108.64	117.88
2800	1.03	5.04	10.21	20.14	39.88	59.83	79.13	99.38	108.78	118.00
3000	1.03	5.01	10.11	20.08	39.82	59.73	79.43	99.47	108.92	118.40
3200	1.03	5.00	10.05	20.05	39.79	59.72	78.85	99.53	109.10	118.72
3400	1.03	5.02	10.02	20.07	39.83	59.75	78.94	99.69	109.38	119.28
3600	1.04	5.07	10.03	20.11	39.89	59.75	79.50	99.84	109.43	119.43
3800	1.04	5.11	10.05	20.17	39.98	59.86	79.37	100.02	109.75	119.88
4000	1.04	5.15	10.08	20.22	40.08	59.93	79.40	100.19	109.95	120.06
4200	1.03	5.17	10.11	20.25	40.16	59.90	80.06	100.39	110.08	120.43
4400	1.03	5.17	10.13	20.26	40.21	59.95	79.93	100.52	110.35	120.81
4600	1.02	5.16	10.12	20.25	40.25	59.89	80.11	100.63	110.48	120.47
4800	1.00	5.15	10.10	20.23	40.27	59.94	79.83	100.68	110.60	121.35
5000	0.99	5.13	10.07	20.21	40.28	59.88	79.75	100.71	110.68	121.48
5200	0.99	5.13	10.05	20.23	40.32	59.95	80.63	100.84	110.75	121.28
5400	1.00	5.14	10.04	20.27	40.36	59.94	79.78	100.90	110.84	122.27
5600	1.00	5.13	10.03	20.31	40.38	59.95	80.69	100.91	110.97	121.86
5800	1.00	5.11	10.02	20.32	40.39	60.03	79.86	101.00	110.97	122.72
6000	0.99	5.06	10.00	20.30	40.34	60.11	79.30	100.94	110.88	121.99
6200	0.98	5.02	9.98	20.24	40.24	59.91	81.04	100.82	110.62	122.31
6300	0.97	4.99	9.98	20.20	40.18	59.95	79.65	100.77	110.79	121.96
6400	0.96	4.97	9.98	20.15	40.12	59.90	79.79	100.67	110.87	121.65
6500	0.96	4.95	9.98	20.10	40.04	59.87	80.49	100.61	110.69	121.32
6600	0.95	4.93	9.97	20.03	39.95	59.80	80.46	100.50	110.38	121.89
6700	0.95	4.91	9.97	19.95	39.83	59.79	79.60	100.34	110.42	121.64
6800	0.94	4.90	9.97	19.87	39.74	59.65	80.26	100.18	110.28	121.60
6900	0.94	4.89	9.97	19.81	39.65	59.49	80.91	100.03	110.11	120.96
7000	0.95	4.91	10.01	19.79	39.60	59.55	81.23	99.82	109.90	121.01
7100	0.96	4.94	10.05	19.81	39.59	59.51	78.86	99.78	109.82	120.94
7200	0.98	4.98	10.11	19.84	39.59	59.62	79.49	99.75	109.61	120.71
7300	0.99	5.03	10.17	19.89	39.60	59.61	79.48	99.74	109.69	120.34
7400	1.01	5.07	10.23	19.95	39.62	59.55	79.50	99.56	109.55	119.99
7500	1.02	5.11	10.27	20.01	39.64	59.59	79.80	99.47	109.16	120.07
7600	1.03	5.13	10.31	20.08	39.67	59.59	80.26	99.43	109.12	120.05
7700	1.04	5.15	10.35	20.14	39.69	59.66	78.42	99.26	108.89	119.66
7800	1.04	5.16	10.37	20.20	39.70	59.47	79.31	99.07	108.74	119.34
7900	1.04	5.13	10.34	20.21	39.67	59.38	78.45	98.84	108.51	118.57
8000	1.03	5.11	10.29	20.21	39.62	59.35	79.20	98.68	108.27	117.69

**Notes**

- A. Performance and quality attributes and conditions not expressly stated in this specification document are intended to be excluded and do not form a part of this specification document.
- B. Electrical specifications and performance data contained in this specification document are based on Mini-Circuits' applicable established test performance criteria and measurement instructions.
- C. The parts covered by this specification document are subject to Mini-Circuits' standard limited warranty and terms and conditions (collectively, "Standard Terms"); Purchasers of this part are entitled to the rights and benefits contained therein. For a full statement of the Standard Terms and the exclusive rights and remedies thereunder, please visit Mini-Circuits' website at [www.minicircuits.com/MC1Store/terms.jsp](http://www.minicircuits.com/MC1Store/terms.jsp)





# Programmable Attenuator RC4DAT-8G-120H

## Typical Performance Data @ 50°C

FREQUENCY (MHz)	Attenuation accuracy relative to nominal attenuation setting (dB)									
	1 dB	5 dB	10 dB	20 dB	40 dB	60 dB	80 dB	100 dB	110 dB	120 dB
100	-0.05	-0.08	-0.15	-0.09	0.03	0.44	0.66	1.14	2.23	4.10
200	-0.05	-0.08	-0.14	-0.12	0.01	0.43	0.79	1.23	2.40	4.18
300	-0.04	-0.05	-0.10	-0.10	0.13	0.55	1.20	2.02	3.17	4.99
400	-0.03	-0.01	-0.05	-0.06	0.27	0.69	1.52	2.58	3.79	5.63
500	-0.02	0.03	0.01	-0.01	0.38	0.77	1.65	2.82	4.01	5.75
600	-0.01	0.08	0.07	0.04	0.47	0.81	1.85	2.81	3.91	5.58
700	0.00	0.13	0.12	0.10	0.54	0.89	1.69	2.68	3.72	5.21
800	0.01	0.17	0.15	0.15	0.59	0.92	1.71	2.54	3.54	5.04
900	0.02	0.20	0.16	0.18	0.61	0.93	1.65	2.37	3.36	4.79
1000	0.02	0.21	0.15	0.18	0.61	0.87	1.49	2.23	3.13	4.52
1100	0.02	0.20	0.13	0.17	0.58	0.86	1.52	2.09	3.00	4.39
1200	0.01	0.19	0.08	0.14	0.53	0.79	1.46	1.96	2.83	4.10
1300	0.01	0.16	0.02	0.09	0.48	0.71	1.33	1.84	2.68	3.83
1400	0.00	0.14	-0.03	0.06	0.41	0.61	1.22	1.68	2.48	3.58
1500	0.00	0.12	-0.06	0.03	0.37	0.53	1.01	1.57	2.39	3.58
1600	0.00	0.12	-0.08	0.02	0.34	0.53	1.09	1.48	2.25	3.47
1700	0.01	0.12	-0.09	0.03	0.33	0.49	1.03	1.40	2.16	3.30
1800	0.01	0.12	-0.09	0.03	0.33	0.46	0.92	1.34	2.06	3.08
1900	0.02	0.12	-0.10	0.03	0.32	0.42	0.89	1.25	1.95	2.93
2000	0.02	0.11	-0.11	0.02	0.30	0.37	0.92	1.18	1.88	2.73
2200	0.01	0.06	-0.17	-0.04	0.21	0.30	0.53	1.01	1.68	2.54
2400	-0.01	-0.01	-0.25	-0.13	0.12	0.22	0.50	0.82	1.49	2.23
2600	-0.03	-0.05	-0.27	-0.17	0.08	0.14	0.54	0.69	1.36	2.12
2800	-0.03	-0.04	-0.21	-0.14	0.12	0.17	0.76	0.62	1.22	2.00
3000	-0.03	-0.01	-0.11	-0.08	0.18	0.27	0.62	0.53	1.08	1.60
3200	-0.03	0.00	-0.05	-0.05	0.21	0.28	0.70	0.47	0.90	1.27
3400	-0.03	-0.02	-0.02	-0.07	0.17	0.25	0.59	0.31	0.62	0.72
3600	-0.04	-0.07	-0.03	-0.11	0.11	0.25	0.52	0.16	0.57	0.57
3800	-0.04	-0.11	-0.05	-0.17	0.02	0.14	0.31	-0.02	0.25	0.12
4000	-0.04	-0.15	-0.08	-0.22	-0.08	0.07	0.23	-0.19	0.05	-0.06
4200	-0.03	-0.17	-0.11	-0.25	-0.16	0.10	0.10	-0.39	-0.08	-0.43
4400	-0.03	-0.17	-0.13	-0.26	-0.21	0.05	0.01	-0.52	-0.35	-0.81
4600	-0.02	-0.16	-0.12	-0.25	-0.25	0.11	0.25	-0.63	-0.48	-0.47
4800	0.00	-0.15	-0.10	-0.23	-0.27	0.06	0.17	-0.68	-0.60	-1.35
5000	0.01	-0.13	-0.07	-0.21	-0.28	0.12	0.25	-0.71	-0.68	-1.48
5200	0.01	-0.13	-0.05	-0.23	-0.32	0.05	-0.18	-0.84	-0.75	-1.28
5400	0.00	-0.14	-0.04	-0.27	-0.36	0.06	-0.01	-0.90	-0.84	-2.27
5600	0.00	-0.13	-0.03	-0.31	-0.38	0.05	-0.23	-0.91	-0.97	-1.86
5800	0.00	-0.11	-0.02	-0.32	-0.39	-0.03	-0.41	-1.00	-0.97	-2.72
6000	0.01	-0.06	0.00	-0.30	-0.34	-0.11	-0.18	-0.94	-0.88	-1.99
6200	0.02	-0.02	0.02	-0.24	-0.24	0.09	-0.22	-0.82	-0.62	-2.31
6300	0.03	0.01	0.02	-0.20	-0.18	0.05	-0.06	-0.77	-0.79	-1.96
6400	0.04	0.03	0.02	-0.15	-0.12	0.10	-0.17	-0.67	-0.87	-1.65
6500	0.04	0.05	0.02	-0.10	-0.04	0.13	-0.14	-0.61	-0.69	-1.32
6600	0.05	0.07	0.03	-0.03	0.05	0.20	0.08	-0.50	-0.38	-1.89
6700	0.05	0.09	0.03	0.05	0.17	0.21	0.21	-0.34	-0.42	-1.64
6800	0.06	0.10	0.03	0.13	0.26	0.35	0.38	-0.18	-0.28	-1.60
6900	0.06	0.11	0.03	0.19	0.35	0.51	0.11	-0.03	-0.11	-0.96
7000	0.05	0.09	-0.01	0.21	0.40	0.45	0.22	0.18	0.10	-1.01
7100	0.04	0.06	-0.05	0.19	0.41	0.49	0.30	0.22	0.18	-0.94
7200	0.02	0.02	-0.11	0.16	0.41	0.38	0.29	0.25	0.39	-0.71
7300	0.01	-0.03	-0.17	0.11	0.40	0.39	0.32	0.26	0.31	-0.34
7400	-0.01	-0.07	-0.23	0.05	0.39	0.45	0.44	0.44	0.45	0.01
7500	-0.02	-0.11	-0.27	-0.01	0.36	0.41	0.00	0.53	0.84	-0.07
7600	-0.03	-0.13	-0.31	-0.08	0.33	0.41	0.49	0.57	0.88	-0.05
7700	-0.04	-0.15	-0.35	-0.14	0.31	0.34	0.61	0.74	1.11	0.34
7800	-0.04	-0.16	-0.37	-0.20	0.30	0.53	1.00	0.93	1.26	0.66
7900	-0.04	-0.13	-0.34	-0.21	0.33	0.62	0.85	1.16	1.49	1.43
8000	-0.03	-0.11	-0.29	-0.21	0.38	0.65	1.21	1.32	1.73	2.31

**Notes**

- A. Performance and quality attributes and conditions not expressly stated in this specification document are intended to be excluded and do not form a part of this specification document.
- B. Electrical specifications and performance data contained in this specification document are based on Mini-Circuit's applicable established test performance criteria and measurement instructions.
- C. The parts covered by this specification document are subject to Mini-Circuit's standard limited warranty and terms and conditions (collectively, "Standard Terms"); Purchasers of this part are entitled to the rights and benefits contained therein. For a full statement of the Standard Terms and the exclusive rights and remedies thereunder, please visit Mini-Circuit's website at [www.minicircuits.com/MC1Store/terms.jsp](http://www.minicircuits.com/MC1Store/terms.jsp)



# Programmable Attenuator RC4DAT-8G-120H

## Typical Performance Data @ 50°C

FREQUENCY (MHz)	Input VSWR (:1)									
	1 dB	5 dB	10 dB	20 dB	40 dB	60 dB	80 dB	100 dB	110 dB	120 dB
100	1.69	1.51	1.22	1.34	1.15	1.13	1.12	1.14	1.13	1.13
200	1.54	1.42	1.14	1.31	1.07	1.06	1.04	1.07	1.06	1.06
300	1.45	1.38	1.12	1.30	1.06	1.04	1.01	1.06	1.05	1.05
400	1.37	1.34	1.10	1.29	1.06	1.04	1.02	1.06	1.05	1.05
500	1.29	1.30	1.09	1.29	1.07	1.05	1.03	1.06	1.05	1.05
600	1.21	1.27	1.07	1.28	1.07	1.06	1.04	1.06	1.07	1.07
700	1.16	1.25	1.05	1.27	1.07	1.08	1.06	1.07	1.08	1.08
800	1.16	1.24	1.04	1.26	1.08	1.09	1.07	1.07	1.09	1.09
900	1.20	1.24	1.04	1.25	1.08	1.10	1.08	1.07	1.10	1.10
1000	1.25	1.25	1.04	1.25	1.08	1.11	1.09	1.07	1.11	1.11
1100	1.29	1.27	1.05	1.24	1.08	1.12	1.10	1.07	1.12	1.12
1200	1.32	1.27	1.05	1.23	1.08	1.13	1.11	1.08	1.13	1.13
1300	1.33	1.27	1.06	1.22	1.08	1.14	1.11	1.08	1.14	1.14
1400	1.32	1.26	1.06	1.21	1.08	1.14	1.12	1.08	1.15	1.15
1500	1.28	1.24	1.06	1.20	1.07	1.15	1.12	1.08	1.15	1.15
1600	1.23	1.20	1.06	1.18	1.07	1.15	1.13	1.07	1.16	1.16
1700	1.18	1.17	1.06	1.17	1.06	1.16	1.13	1.07	1.16	1.16
1800	1.14	1.15	1.06	1.15	1.05	1.16	1.13	1.06	1.17	1.17
1900	1.09	1.13	1.06	1.15	1.05	1.16	1.13	1.06	1.17	1.17
2000	1.06	1.12	1.06	1.14	1.05	1.17	1.14	1.06	1.17	1.17
2200	1.10	1.13	1.05	1.13	1.05	1.17	1.14	1.06	1.18	1.18
2400	1.15	1.15	1.06	1.12	1.06	1.18	1.15	1.08	1.19	1.19
2600	1.22	1.20	1.06	1.14	1.06	1.17	1.14	1.07	1.17	1.17
2800	1.25	1.22	1.07	1.15	1.06	1.16	1.13	1.06	1.17	1.17
3000	1.25	1.23	1.09	1.17	1.07	1.14	1.11	1.06	1.15	1.15
3200	1.24	1.23	1.10	1.17	1.07	1.14	1.11	1.07	1.14	1.14
3400	1.27	1.24	1.12	1.19	1.07	1.12	1.09	1.07	1.12	1.12
3600	1.31	1.26	1.13	1.19	1.08	1.11	1.08	1.07	1.11	1.11
3800	1.32	1.26	1.13	1.20	1.07	1.07	1.04	1.07	1.07	1.07
4000	1.26	1.22	1.10	1.19	1.06	1.06	1.04	1.05	1.06	1.06
4200	1.17	1.17	1.06	1.19	1.06	1.04	1.03	1.05	1.05	1.05
4400	1.07	1.13	1.03	1.18	1.05	1.05	1.04	1.04	1.05	1.05
4600	1.07	1.13	1.04	1.19	1.07	1.06	1.07	1.06	1.06	1.06
4800	1.16	1.14	1.08	1.18	1.07	1.09	1.10	1.06	1.09	1.09
5000	1.26	1.18	1.12	1.19	1.09	1.13	1.15	1.09	1.13	1.13
5200	1.27	1.16	1.13	1.16	1.10	1.17	1.19	1.11	1.17	1.17
5400	1.24	1.13	1.12	1.14	1.12	1.21	1.23	1.14	1.21	1.21
5600	1.16	1.06	1.11	1.12	1.13	1.23	1.25	1.15	1.23	1.23
5800	1.09	1.04	1.17	1.12	1.18	1.29	1.31	1.20	1.29	1.29
6000	1.19	1.16	1.25	1.13	1.23	1.34	1.36	1.25	1.35	1.35
6200	1.35	1.29	1.36	1.16	1.29	1.40	1.41	1.30	1.40	1.40
6300	1.42	1.34	1.40	1.18	1.30	1.41	1.42	1.31	1.42	1.42
6400	1.48	1.38	1.43	1.18	1.31	1.41	1.42	1.31	1.42	1.42
6500	1.50	1.40	1.45	1.19	1.31	1.41	1.41	1.31	1.41	1.41
6600	1.56	1.45	1.50	1.22	1.34	1.44	1.44	1.34	1.44	1.44
6700	1.62	1.50	1.55	1.25	1.38	1.47	1.48	1.37	1.48	1.48
6800	1.68	1.55	1.60	1.29	1.42	1.51	1.52	1.41	1.52	1.52
6900	1.72	1.59	1.65	1.33	1.47	1.56	1.56	1.46	1.56	1.56
7000	1.73	1.62	1.69	1.36	1.51	1.60	1.60	1.50	1.61	1.61
7100	1.68	1.61	1.71	1.39	1.55	1.64	1.62	1.54	1.64	1.64
7200	1.57	1.54	1.66	1.38	1.55	1.63	1.61	1.54	1.64	1.64
7300	1.44	1.46	1.60	1.35	1.52	1.60	1.57	1.52	1.61	1.61
7400	1.35	1.41	1.57	1.35	1.53	1.61	1.57	1.53	1.61	1.61
7500	1.28	1.37	1.54	1.36	1.54	1.62	1.58	1.54	1.62	1.62
7600	1.22	1.33	1.51	1.36	1.53	1.61	1.57	1.54	1.62	1.62
7700	1.22	1.33	1.51	1.37	1.55	1.63	1.59	1.56	1.64	1.64
7800	1.29	1.36	1.55	1.42	1.60	1.68	1.64	1.62	1.70	1.70
7900	1.39	1.42	1.59	1.48	1.66	1.74	1.68	1.68	1.75	1.75
8000	1.50	1.47	1.63	1.53	1.69	1.77	1.70	1.71	1.78	1.78

**Notes**

- A. Performance and quality attributes and conditions not expressly stated in this specification document are intended to be excluded and do not form a part of this specification document.
- B. Electrical specifications and performance data contained in this specification document are based on Mini-Circuit's applicable established test performance criteria and measurement instructions.
- C. The parts covered by this specification document are subject to Mini-Circuits standard limited warranty and terms and conditions (collectively, "Standard Terms"); Purchasers of this part are entitled to the rights and benefits contained therein. For a full statement of the Standard Terms and the exclusive rights and remedies thereunder, please visit Mini-Circuits' website at [www.minicircuits.com/MC1Store/terms.jsp](http://www.minicircuits.com/MC1Store/terms.jsp)



# Programmable Attenuator RC4DAT-8G-120H

## Typical Performance Data @ 50°C

FREQUENCY (MHz)	Output VSWR (:1)									
	1 dB	5 dB	10 dB	20 dB	40 dB	60 dB	80 dB	100 dB	110 dB	120 dB
100	1.72	1.44	1.32	1.17	1.27	1.14	1.15	1.15	1.15	1.12
200	1.56	1.31	1.25	1.10	1.23	1.08	1.08	1.08	1.08	1.06
300	1.47	1.27	1.23	1.08	1.23	1.07	1.08	1.08	1.08	1.04
400	1.37	1.24	1.22	1.07	1.23	1.07	1.08	1.08	1.08	1.03
500	1.26	1.21	1.21	1.07	1.23	1.07	1.08	1.08	1.08	1.03
600	1.16	1.19	1.20	1.07	1.23	1.06	1.08	1.08	1.08	1.03
700	1.07	1.19	1.21	1.07	1.22	1.06	1.08	1.08	1.08	1.04
800	1.07	1.22	1.22	1.08	1.22	1.06	1.08	1.08	1.08	1.04
900	1.15	1.25	1.24	1.08	1.21	1.06	1.08	1.08	1.08	1.04
1000	1.23	1.29	1.26	1.08	1.21	1.06	1.08	1.08	1.08	1.05
1100	1.30	1.33	1.28	1.09	1.20	1.06	1.08	1.08	1.08	1.06
1200	1.36	1.36	1.29	1.09	1.19	1.06	1.08	1.08	1.08	1.06
1300	1.40	1.38	1.30	1.09	1.19	1.07	1.08	1.08	1.08	1.07
1400	1.41	1.38	1.31	1.09	1.18	1.07	1.08	1.08	1.08	1.07
1500	1.40	1.37	1.30	1.09	1.17	1.06	1.08	1.08	1.08	1.07
1600	1.38	1.36	1.29	1.07	1.16	1.06	1.07	1.07	1.07	1.07
1700	1.36	1.34	1.28	1.06	1.14	1.06	1.07	1.06	1.07	1.08
1800	1.35	1.33	1.26	1.05	1.13	1.06	1.06	1.06	1.06	1.08
1900	1.35	1.32	1.25	1.03	1.12	1.06	1.06	1.06	1.06	1.09
2000	1.36	1.31	1.24	1.02	1.10	1.06	1.06	1.06	1.06	1.09
2200	1.41	1.32	1.22	1.02	1.08	1.07	1.06	1.06	1.06	1.10
2400	1.49	1.35	1.22	1.06	1.07	1.08	1.06	1.06	1.06	1.11
2600	1.55	1.38	1.23	1.10	1.07	1.09	1.07	1.07	1.07	1.12
2800	1.57	1.40	1.24	1.14	1.08	1.10	1.08	1.08	1.08	1.13
3000	1.54	1.40	1.25	1.16	1.10	1.12	1.09	1.09	1.09	1.14
3200	1.45	1.37	1.25	1.18	1.12	1.13	1.10	1.10	1.10	1.15
3400	1.33	1.32	1.23	1.19	1.13	1.13	1.11	1.11	1.11	1.15
3600	1.21	1.27	1.23	1.19	1.15	1.14	1.12	1.12	1.12	1.15
3800	1.13	1.22	1.22	1.19	1.16	1.15	1.13	1.13	1.13	1.16
4000	1.11	1.18	1.23	1.18	1.17	1.15	1.13	1.13	1.13	1.15
4200	1.15	1.14	1.24	1.16	1.18	1.15	1.13	1.13	1.13	1.15
4400	1.17	1.10	1.23	1.14	1.18	1.14	1.12	1.12	1.12	1.13
4600	1.16	1.09	1.22	1.12	1.18	1.13	1.12	1.12	1.12	1.12
4800	1.13	1.13	1.21	1.10	1.19	1.12	1.11	1.11	1.11	1.11
5000	1.16	1.20	1.22	1.09	1.20	1.10	1.10	1.10	1.10	1.09
5200	1.21	1.26	1.24	1.09	1.20	1.09	1.09	1.09	1.09	1.07
5400	1.26	1.31	1.25	1.10	1.22	1.08	1.09	1.09	1.09	1.05
5600	1.28	1.32	1.24	1.11	1.23	1.08	1.10	1.10	1.10	1.05
5800	1.28	1.29	1.21	1.10	1.23	1.09	1.12	1.12	1.12	1.07
6000	1.24	1.22	1.15	1.08	1.22	1.11	1.14	1.14	1.14	1.10
6200	1.16	1.13	1.07	1.05	1.20	1.13	1.17	1.17	1.17	1.13
6300	1.13	1.11	1.04	1.06	1.19	1.14	1.18	1.18	1.18	1.15
6400	1.13	1.13	1.04	1.09	1.19	1.15	1.20	1.20	1.20	1.16
6500	1.17	1.18	1.08	1.12	1.19	1.17	1.22	1.22	1.22	1.18
6600	1.25	1.25	1.14	1.16	1.19	1.19	1.24	1.24	1.24	1.21
6700	1.35	1.34	1.21	1.21	1.18	1.21	1.26	1.26	1.26	1.23
6800	1.46	1.44	1.27	1.26	1.19	1.23	1.28	1.29	1.29	1.26
6900	1.56	1.53	1.34	1.31	1.19	1.25	1.30	1.30	1.30	1.28
7000	1.64	1.61	1.39	1.35	1.19	1.26	1.31	1.32	1.32	1.30
7100	1.70	1.67	1.43	1.39	1.19	1.27	1.32	1.32	1.32	1.31
7200	1.73	1.70	1.46	1.41	1.18	1.28	1.33	1.33	1.33	1.32
7300	1.76	1.73	1.49	1.44	1.18	1.29	1.34	1.34	1.34	1.34
7400	1.77	1.75	1.51	1.46	1.18	1.30	1.35	1.35	1.35	1.36
7500	1.77	1.75	1.52	1.47	1.19	1.32	1.37	1.37	1.37	1.37
7600	1.75	1.74	1.52	1.49	1.20	1.35	1.39	1.39	1.39	1.40
7700	1.72	1.70	1.51	1.50	1.20	1.37	1.41	1.41	1.41	1.43
7800	1.67	1.65	1.50	1.50	1.21	1.40	1.43	1.43	1.43	1.46
7900	1.60	1.57	1.46	1.48	1.20	1.41	1.44	1.44	1.44	1.48
8000	1.50	1.48	1.40	1.46	1.19	1.42	1.44	1.44	1.44	1.49

**Notes**

- A. Performance and quality attributes and conditions not expressly stated in this specification document are intended to be excluded and do not form a part of this specification document.
- B. Electrical specifications and performance data contained in this specification document are based on Mini-Circuit's applicable established test performance criteria and measurement instructions.
- C. The parts covered by this specification document are subject to Mini-Circuit's standard limited warranty and terms and conditions (collectively, "Standard Terms"). Purchasers of this part are entitled to the rights and benefits contained therein. For a full statement of the Standard Terms and the exclusive rights and remedies thereunder, please visit Mini-Circuit's website at [www.minicircuits.com/MC1Store/terms.jsp](http://www.minicircuits.com/MC1Store/terms.jsp)



# Programmable Attenuator RC4DAT-8G-120H

## Typical Performance Data @ 50°C

FREQUENCY (MHz)	Cross-Over Isolation (dB)									
	In1-In2	In2-In3	In3-In4	Out1- Out2	Out2- Out3	Out3- Out4	In1- Out2	Out1- In2	In3- Out4	Out3- In4
100	151.65	152.40	149.19	150.62	147.50	147.39	151.99	148.64	149.58	152.36
200	150.45	148.02	151.09	149.72	147.66	149.12	150.77	149.46	147.75	151.10
300	152.05	148.28	150.90	149.62	148.49	147.69	151.79	152.73	148.79	151.95
400	149.24	151.33	148.89	149.04	147.88	148.30	153.81	150.98	147.19	149.71
500	149.90	147.81	147.96	149.95	150.18	148.06	151.88	149.41	146.21	149.61
600	151.32	148.82	148.47	150.06	146.12	145.02	150.67	150.00	146.09	150.74
700	151.07	148.17	149.29	152.08	145.84	145.78	150.41	151.24	146.18	150.74
800	148.91	148.67	148.71	149.08	145.49	146.86	151.54	150.87	147.10	149.74
900	150.24	150.73	148.19	151.94	146.14	148.09	152.63	149.33	146.51	149.43
1000	150.43	147.50	148.83	152.44	145.76	147.85	151.21	151.07	144.98	150.42
1100	149.35	147.20	148.99	149.77	146.31	146.24	151.74	151.47	145.25	150.30
1200	150.12	146.75	148.21	152.81	145.76	148.05	150.31	149.79	146.88	151.09
1300	148.30	147.85	150.84	149.73	146.67	148.16	150.46	148.39	145.89	151.80
1400	149.27	145.38	148.74	150.73	145.54	145.96	148.92	149.75	144.70	151.22
1500	149.97	148.49	147.42	149.76	146.39	145.96	151.14	147.53	147.84	149.85
1600	149.58	147.32	149.67	148.54	146.83	146.39	150.11	149.66	146.16	150.14
1700	148.21	148.50	150.47	149.75	147.95	147.16	150.54	150.02	145.84	150.45
1800	149.65	147.14	149.16	149.22	147.40	144.23	149.93	148.64	146.56	150.75
1900	148.75	147.59	149.51	150.24	144.28	144.60	150.62	151.40	145.73	150.31
2000	147.81	149.71	146.66	148.49	145.85	146.47	152.36	149.86	148.13	148.36
2200	137.63	148.12	140.39	151.23	146.49	145.43	150.77	150.24	147.13	147.56
2400	144.93	145.87	146.13	149.08	146.30	147.09	151.06	148.41	146.10	150.14
2600	149.49	145.83	147.89	150.22	145.50	147.82	150.65	147.14	147.68	149.61
2800	149.10	137.07	147.14	149.61	147.70	146.88	152.17	148.36	147.38	148.47
3000	148.53	149.80	150.26	148.83	145.07	146.94	151.95	147.85	145.69	148.71
3200	148.40	147.31	148.69	149.15	147.88	145.45	152.31	148.36	145.69	148.44
3400	145.07	144.78	147.36	148.15	148.27	146.89	149.53	146.50	145.31	151.26
3600	144.72	148.58	147.59	149.73	147.96	146.10	150.17	149.50	146.32	150.45
3800	148.82	145.96	147.98	150.23	147.31	147.32	151.54	149.57	144.83	151.34
4000	147.76	147.84	150.37	148.66	146.82	147.64	149.60	147.31	145.94	149.37
4200	147.76	147.75	144.76	148.55	148.17	147.88	149.35	147.16	145.70	148.15
4400	147.82	147.10	147.58	149.92	146.02	146.29	151.35	147.40	144.20	148.31
4600	149.00	145.06	146.03	147.21	146.48	144.55	150.82	147.73	144.52	150.59
4800	147.45	148.18	144.89	152.17	146.07	143.96	150.21	146.43	146.14	147.69
5000	145.00	147.83	148.35	148.07	144.87	145.35	150.83	147.76	147.36	150.26
5200	144.73	146.49	146.03	149.09	144.27	146.50	147.50	146.66	142.33	144.46
5400	144.08	145.70	144.98	144.29	144.25	143.56	149.61	146.96	145.62	146.68
5600	146.51	145.74	142.88	145.61	140.43	143.14	148.11	144.84	143.97	146.36
5800	146.82	146.64	147.70	148.18	145.08	143.51	149.82	146.77	144.52	148.53
6000	143.66	143.90	143.84	146.57	145.95	145.97	147.88	144.54	143.01	144.34
6200	138.79	143.10	141.44	145.97	140.82	142.22	144.73	144.84	143.70	143.56
6300	143.85	144.14	143.02	147.31	144.26	145.78	149.04	145.82	143.96	147.14
6400	142.81	142.60	141.81	146.93	143.92	143.09	149.56	145.60	145.11	146.25
6500	144.86	143.98	144.35	146.84	143.28	144.94	147.60	146.03	142.89	149.63
6600	143.66	146.62	146.46	146.68	145.32	142.37	150.41	147.72	144.56	148.15
6700	146.42	146.44	146.90	146.85	144.52	144.74	147.78	147.98	147.00	147.41
6800	144.42	144.04	143.88	147.84	143.36	142.21	145.73	148.03	143.58	146.08
6900	138.09	139.93	139.66	145.77	142.70	144.54	143.47	144.00	142.10	143.29
7000	138.26	137.39	134.95	147.59	140.89	141.38	144.80	142.16	141.12	142.52
7100	139.29	141.41	138.35	146.44	139.15	141.75	143.01	144.03	141.05	141.51
7200	143.73	144.27	142.58	145.42	140.95	143.36	144.65	145.43	142.09	144.64
7300	146.06	142.27	144.25	147.04	142.57	142.96	145.78	146.43	142.85	142.84
7400	142.39	142.04	144.65	144.33	143.07	142.34	147.27	144.79	144.42	145.08
7500	143.02	145.49	145.89	142.68	140.20	143.76	146.08	145.10	142.85	144.38
7600	140.36	143.31	142.92	142.38	141.73	142.30	145.61	144.02	142.62	143.08
7700	141.73	140.42	142.03	138.99	142.21	140.38	143.62	143.04	143.85	142.46
7800	139.30	138.95	140.78	139.24	139.47	140.10	141.13	141.32	141.04	139.52
7900	131.40	138.69	140.33	137.87	139.37	141.49	140.41	141.43	139.92	138.85
8000	123.26	135.78	139.49	138.19	139.00	139.62	140.36	139.61	139.98	139.46

**Notes**

- A. Performance and quality attributes and conditions not expressly stated in this specification document are intended to be excluded and do not form a part of this specification document.
- B. Electrical specifications and performance data contained in this specification document are based on Mini-Circuit's applicable established test performance criteria and measurement instructions.
- C. The parts covered by this specification document are subject to Mini-Circuits standard limited warranty and terms and conditions (collectively, "Standard Terms"). Purchasers of this part are entitled to the rights and benefits contained therein. For a full statement of the Standard Terms and the exclusive rights and remedies thereunder, please visit Mini-Circuits' website at [www.minicircuits.com/ACL/Store/terms.jsp](http://www.minicircuits.com/ACL/Store/terms.jsp)



# Programmable Attenuator RC4DAT-8G-120H

## Typical Performance Data @ 50°C

FREQUENCY (MHz)	I. Loss (dB)
100	4.36
200	4.38
300	4.50
400	4.63
500	4.77
600	4.93
700	5.08
800	5.22
900	5.35
1000	5.47
1100	5.53
1200	5.59
1300	5.66
1400	5.77
1500	5.87
1600	5.91
1700	5.93
1800	5.97
1900	6.02
2000	6.07
2200	6.18
2400	6.29
2600	6.48
2800	6.74
3000	7.02
3200	7.27
3400	7.47
3600	7.66
3800	7.83
4000	8.00
4200	8.20
4400	8.42
4600	8.67
4800	8.94
5000	9.21
5200	9.45
5400	9.67
5600	9.90
5800	10.17
6000	10.47
6200	10.81
6300	10.99
6400	11.18
6500	11.40
6600	11.64
6700	11.90
6800	12.14
6900	12.37
7000	12.54
7100	12.68
7200	12.78
7300	12.88
7400	12.98
7500	13.07
7600	13.15
7700	13.23
7800	13.32
7900	13.44
8000	13.55

FREQUENCY (MHz)	IP3 (dBm)
1	24.21
10	34.15
50	44.86
100	47.23
200	50.23
500	50.82
1000	54.18
1500	51.94
2000	51.52
2500	54.02
3000	50.31
3500	53.65
4000	52.66
4500	51.22
5000	52.70
5500	49.06
6000	46.64
6500	49.88
7000	48.31
7500	48.26
8000	47.94

**Notes**

- A. Performance and quality attributes and conditions not expressly stated in this specification document are intended to be excluded and do not form a part of this specification document.
- B. Electrical specifications and performance data contained in this specification document are based on Mini-Circuit's applicable established test performance criteria and measurement instructions.
- C. The parts covered by this specification document are subject to Mini-Circuits standard limited warranty and terms and conditions (collectively, "Standard Terms"); Purchasers of this part are entitled to the rights and benefits contained therein. For a full statement of the Standard Terms and the exclusive rights and remedies thereunder, please visit Mini-Circuits' website at [www.minicircuits.com/MC1Store/terms.jsp](http://www.minicircuits.com/MC1Store/terms.jsp)



# Programmable Attenuator

# RC4DAT-8G-120H

## Typical Performance Curves @ 0°C

**Attenuation Accuracy vs. Frequency over Attenuation settings**

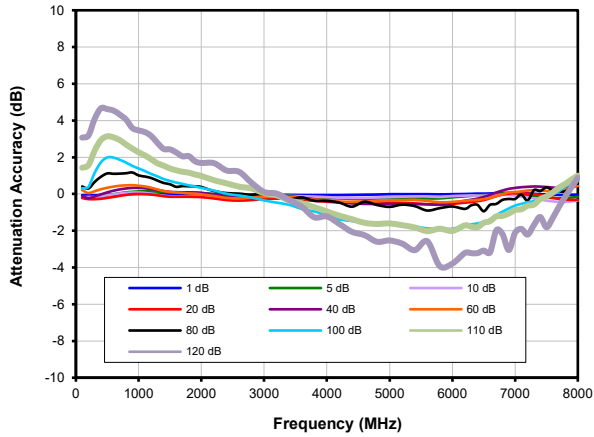

**Insertion Loss**

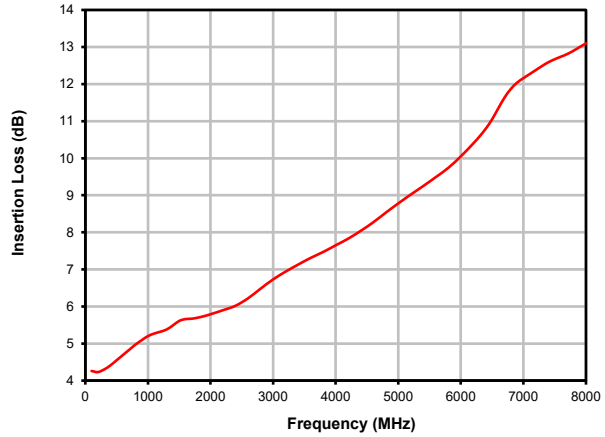

**Input VSWR vs. Frequency over Attenuation settings**

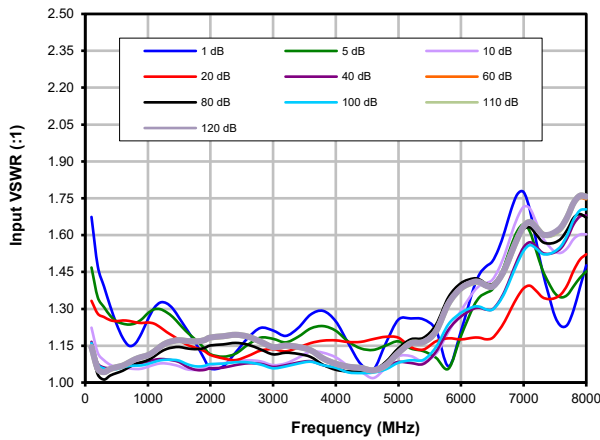

**Output VSWR vs. Frequency over Attenuation settings**

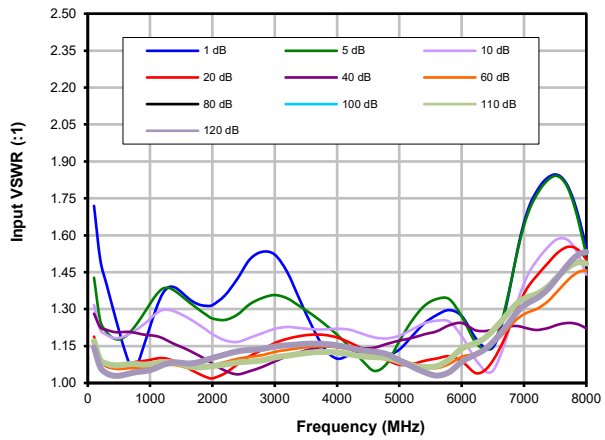

**IP3 @ 0dB Attenuation**

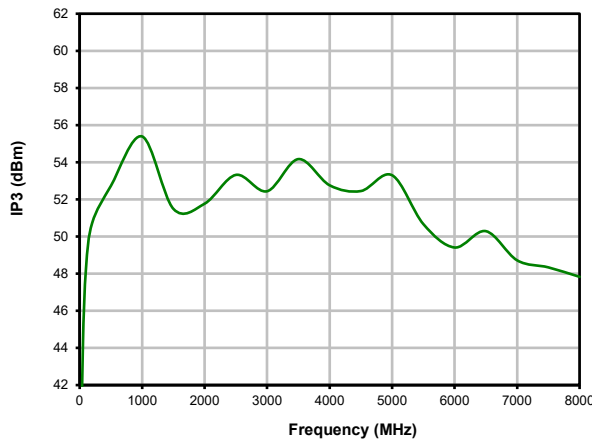

**Cross Over Isolation vs. Frequency @ Attenuation setting 0 dB**

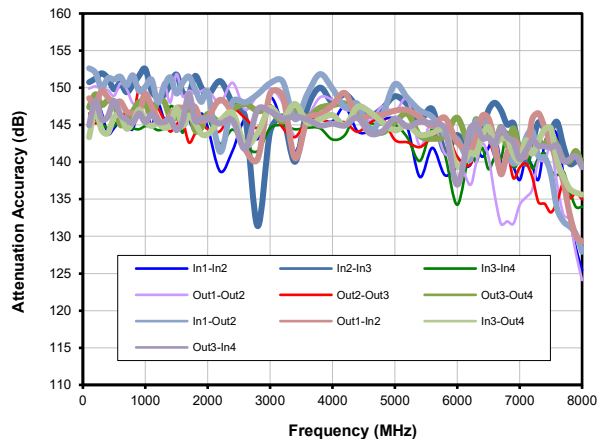

**Notes**

- A. Performance and quality attributes and conditions not expressly stated in this specification document are intended to be excluded and do not form a part of this specification document.
- B. Electrical specifications and performance data contained in this specification document are based on Mini-Circuit's applicable established test performance criteria and measurement instructions.
- C. The parts covered by this specification document are subject to Mini-Circuits standard limited warranty and terms and conditions (collectively, "Standard Terms"); Purchasers of this part are entitled to the rights and benefits contained therein. For a full statement of the Standard Terms and the exclusive rights and remedies thereunder, please visit Mini-Circuits' website at [www.minicircuits.com/MCLStore/terms.jsp](http://www.minicircuits.com/MCLStore/terms.jsp)





# Programmable Attenuator

# RC4DAT-8G-120H

## Typical Performance Curves @ 25°C

**Attenuation Accuracy vs. Frequency over Attenuation settings**

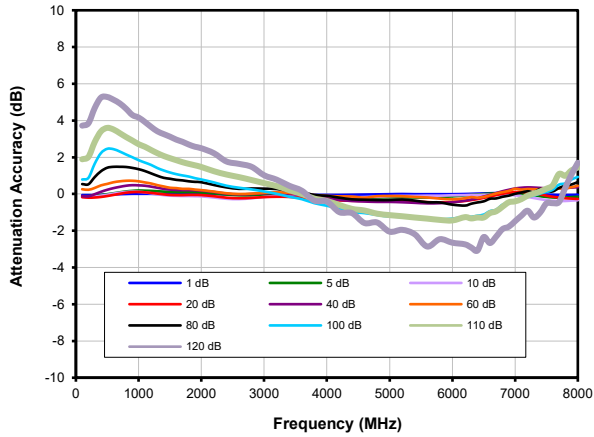

**Insertion Loss**

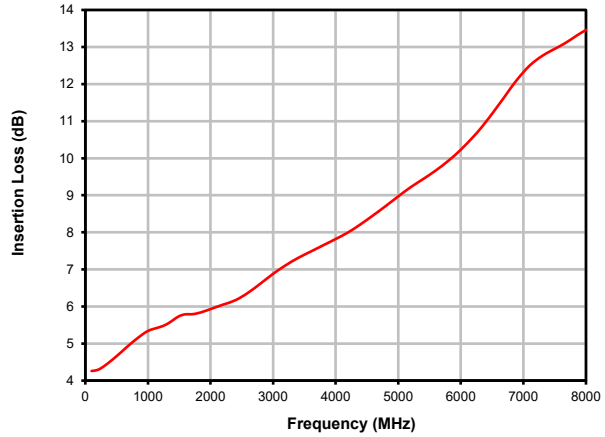

**Input VSWR vs. Frequency over Attenuation settings**

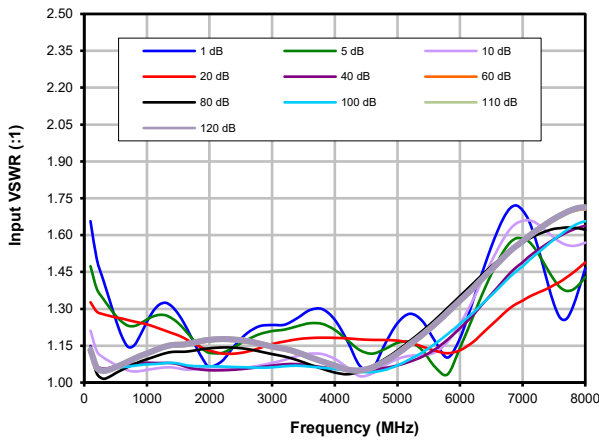

**Output VSWR vs. Frequency over Attenuation settings**

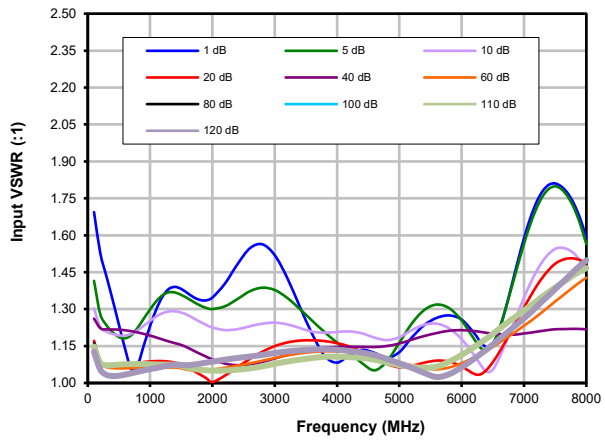

**IP3 @ 0dB Attenuation**

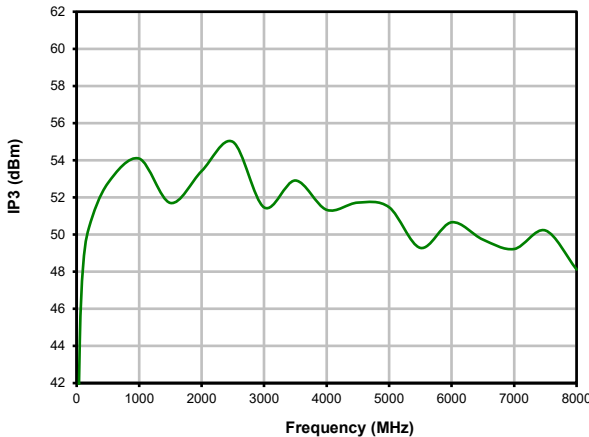

**Cross Over Isolation vs. Frequency @ Attenuation setting 0 dB**

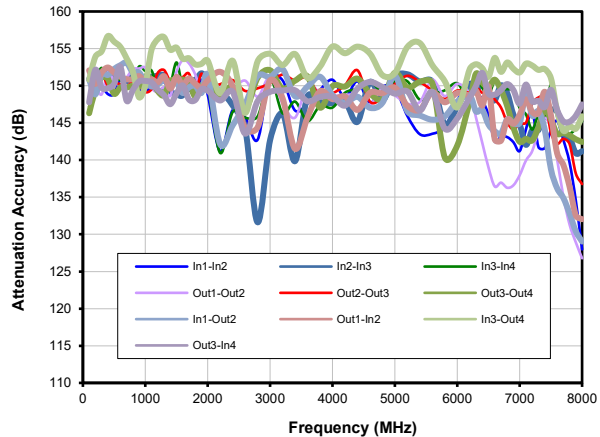

**Notes**

- A. Performance and quality attributes and conditions not expressly stated in this specification document are intended to be excluded and do not form a part of this specification document.
- B. Electrical specifications and performance data contained in this specification document are based on Mini-Circuit's applicable established test performance criteria and measurement instructions.
- C. The parts covered by this specification document are subject to Mini-Circuits standard limited warranty and terms and conditions (collectively, "Standard Terms"); Purchasers of this part are entitled to the rights and benefits contained therein. For a full statement of the Standard Terms and the exclusive rights and remedies thereunder, please visit Mini-Circuits' website at [www.minicircuits.com/MCLStore/terms.jsp](http://www.minicircuits.com/MCLStore/terms.jsp)





# Programmable Attenuator

# RC4DAT-8G-120H

## Typical Performance Curves @ 50°C

**Attenuation Accuracy vs. Frequency over Attenuation settings**

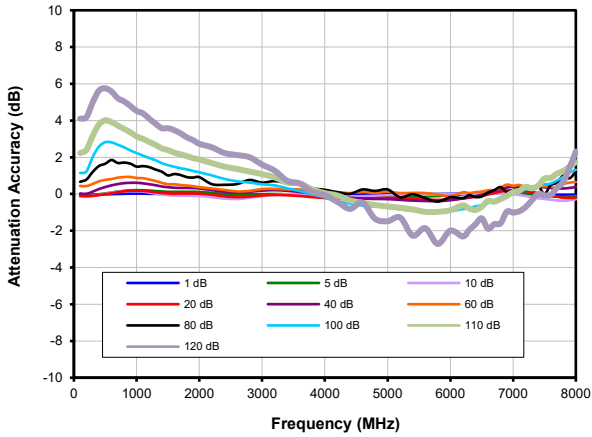

**Insertion Loss**

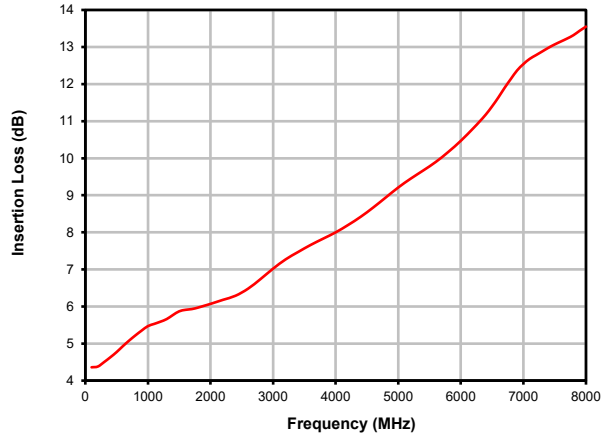

**Input VSWR vs. Frequency over Attenuation settings**

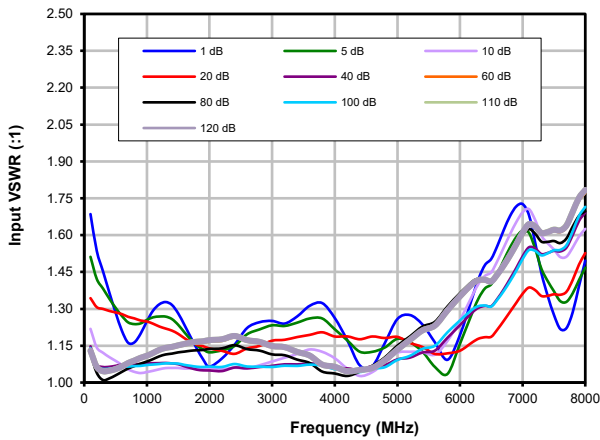

**Output VSWR vs. Frequency over Attenuation settings**

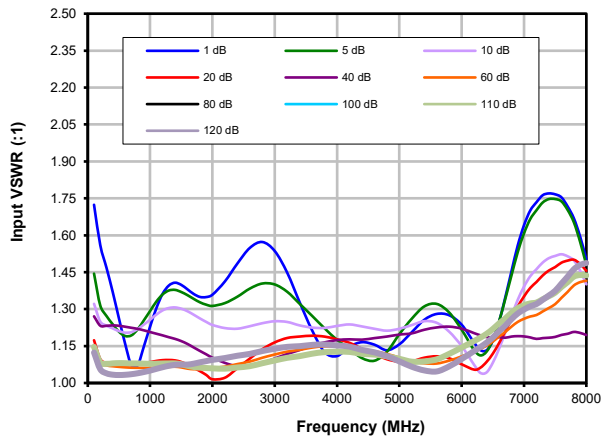

**IP3 @ 0dB Attenuation**

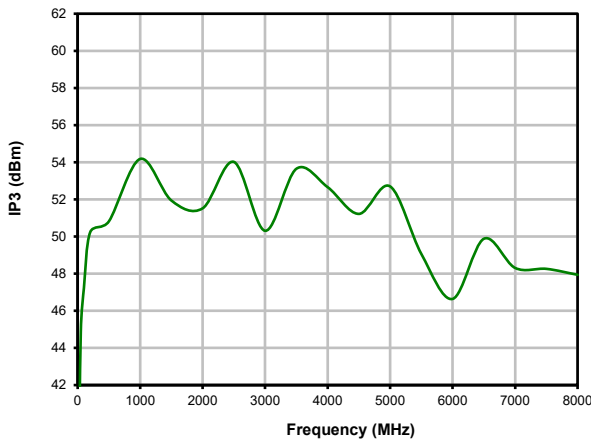

**Cross Over Isolation vs. Frequency @ Attenuation setting 0 dB**

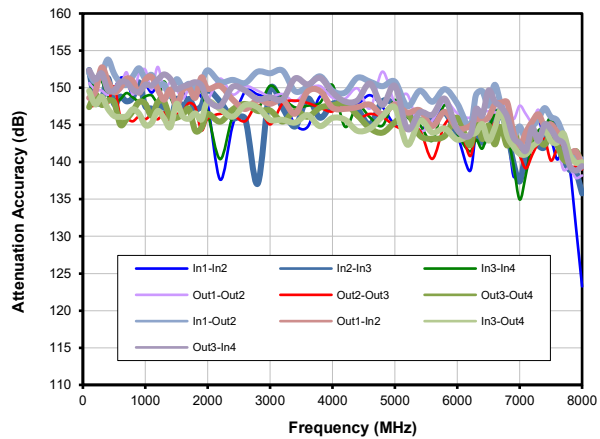

**Notes**

- A. Performance and quality attributes and conditions not expressly stated in this specification document are intended to be excluded and do not form a part of this specification document.
- B. Electrical specifications and performance data contained in this specification document are based on Mini-Circuit's applicable established test performance criteria and measurement instructions.
- C. The parts covered by this specification document are subject to Mini-Circuits standard limited warranty and terms and conditions (collectively, "Standard Terms"); Purchasers of this part are entitled to the rights and benefits contained therein. For a full statement of the Standard Terms and the exclusive rights and remedies thereunder, please visit Mini-Circuits' website at [www.minicircuits.com/MCLStore/terms.jsp](http://www.minicircuits.com/MCLStore/terms.jsp)



# Case Style

# QE

## Outline Dimensions

## QE2671

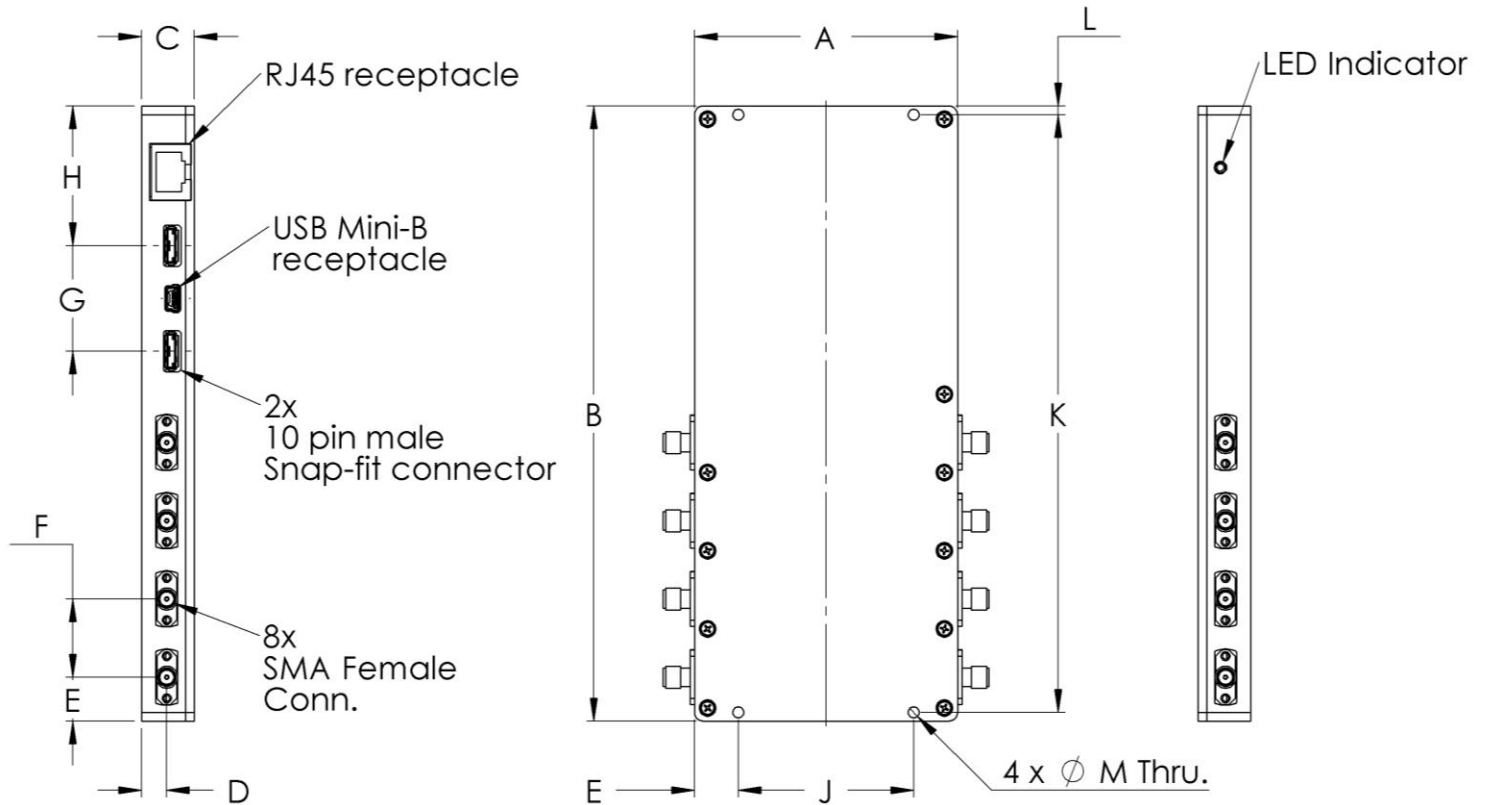

CASE#	A	B	C	D	E	F	G	H	J	K	L	M	WT. GRAMS
QE2671	3.00 (76.2)	7.00 (177.8)	.60 (15.24)	.287 (7.29)	.50 (12.7)	.890 (22.61)	1.20 (30.5)	1.59 (40.4)	2.000 (50.80)	6.800 (172.72)	.10 (2.54)	.125 (3.18)	500

Dimensions are in inches (mm). Tolerances: 2PL. +/- .03; 3PL. +/- .015

### Notes:

1. Case material: Aluminum.
2. Case finish: Clear chemical conversion coating, non-chrome or trivalent chrome based.

**Mini-Circuits**<sup>®</sup>

INTERNET <http://www.minicircuits.com>

P.O. Box 350166, Brooklyn, New York 11235-0003 (718) 934-4500 Fax (718) 332-4661

Distribution Centers NORTH AMERICA 800-654-7949 • 417-335-5935 • Fax 417-335-5945 • EUROPE 44-1252-832600 • Fax 44-1252-837010

Mini-Circuits ISO 9001 & ISO 14001 Certified



Environmental Specifications **ENV55T1**

All Mini-Circuits products are manufactured under exacting quality assurance and control standards, and are capable of meeting published specifications after being subjected to any or all of the following physical and environmental test.

Specification	Test/Inspection Condition	Reference/Spec
Operating Temperature	-0° to 50° C Ambient Environment	Individual Model Data Sheet
Storage Temperature	-20° to 85° C Ambient Environment	Individual Model Data Sheet
Operating and Storage Humidity	5% to 85% RH (non-condensing)	Ambient
Bench Handling Test	Bench Top Tip 45° & Drop	MIL-PRF-28800F
Transit Drop Test	Free Fall Drop, 20 cm (7.9 inches)	MIL-PRF-28800F Class 3