



USB & ETHERNET CONTROLLED

Millimeter Wave Switch Matrix **RC-2SP4T-50**

50Ω DC to 50 GHz 2.4 mm-Female

THE BIG DEAL

- Millimeter wave switching (up to 50 GHz)
- Excellent performance to 50 GHz
- High reliability, 2 million switch cycles
- 3W power rating (cold switching)

APPLICATIONS

- 5G node / device testing
- Automated test equipment
- Fail-safe / redundancy switching



CASE STYLE: MR2616

[DOWNLOAD](#) SOFTWARE PACKAGE

RoHS Compliant

See our website for RoHS Compliance methodologies and qualifications

PRODUCT OVERVIEW

Mini-Circuits' RC-2SP4T-50 houses a pair of electro-mechanical SP4T switch operating over an extremely wide bandwidth, from DC to 50 GHz with high isolation and low insertion loss. The absorptive switches are of a failsafe and break-before-make-configuration, with a minimum lifetime of 2 million switching cycles per switch position, when used within the noted specifications.

The switch box is constructed in a compact, rugged metal case (5.5 x 6.0 x 2.75") with all 2.4 mm (f) RF connectors on the front panel. The switches are controlled via USB or Ethernet, allowing control directly from a PC, or remotely over a network. Full software support is provided, including our user-friendly GUI application for Windows and a full API with programming instructions for Windows and Linux environments (both 32-bit and 64-bit systems).

KEY FEATURES

Feature	Advantages
Mechanical SP4T switches	Mechanical absorptive switches provide high reliability, repeatable high performance and internal terminations of input signals on the disconnected paths
Operation from DC to 50 GHz	Supports a wide range of RF test and signal routing applications, including 2G, 3G, 4G and 5G, with a single device.
Break-before-make configuration	Prevents a momentary connection of the old and new signal paths, reducing the inconsistent transient effects that could otherwise be observed during switching
USB & Ethernet control	USB HID and Ethernet (HTTP / Telnet) interfaces provide easy compatibility with a wide range of software setups and programming environments
Full software support	User friendly Windows GUI (graphical user interface) allows manual control straight out of the box, while the comprehensive API (application programming interface) with examples and instructions allows easy automation in most programming environments

REV. B
ECO-009505
RC-2SP4T-50
MCL NY
240130





USB & ETHERNET CONTROLLED

Millimeter Wave Switch Matrix **RC-2SP4T-50**

50Ω DC to 50 GHz 2.4 mm-Female

ELECTRICAL SPECIFICATIONS AT 25°C

Parameter	Conditions (GHz)	Min.	Typ.	Max.	Units
Frequency Range		DC		50	GHz
Insertion Loss	DC - 18	—	0.2	0.5	dB
	18 - 26.5	—	0.2	0.7	
	26.5 - 40	—	0.3	0.9	
	40 - 50	—	0.4	1.2	
Isolation	DC - 18	60	90	—	dB
	18 - 26.5	55	85	—	
	26.5 - 40	50	75	—	
	40 - 50	50	75	—	
VSWR	DC - 18	—	1.2	—	:1
	18 - 26.5	—	1.2	—	
	26.5 - 40	—	1.3	—	
	40 - 50	—	1.5	—	
Switching Time	—	—	25	—	ms
RF Input Power (Cold Switching) ¹	DC - 18	—	—	20	W
	18 - 26.5	—	—	10	
	26.5 - 50	—	—	3	
Switch Lifetime (per Switch)	100mW hot switching ²	2	—	—	million cycles
	1W hot switching	—	1	—	
Rated Voltage	24V _{DC} input	23	24	25	V
	USB port	—	5	—	
Rated Current (24V DC Input)	State 1-4	—	330	—	mA
	State 0	—	90	120	
Rated Current (USB)		—	10	20	mA

1. Maximum power for any connected through path as stated; maximum power into any internal termination is 1W per port, 3W total per switch

2. Hot switching powers above this level will degrade the switch lifetime

ABSOLUTE MAXIMUM RATINGS

Parameters	Ratings
Operating Temperature	0°C to 40°C
Storage Temperature	-15°C to 85°C
Supply Voltage	26V



USB & ETHERNET CONTROLLED

Millimeter Wave Switch Matrix **RC-2SP4T-50**

50Ω DC to 50 GHz 2.4 mm-Female

SWITCHING CONFIGURATION:

- Normally open (all port disconnected)
- Absorptive (internal terminations on ports J1-J4)

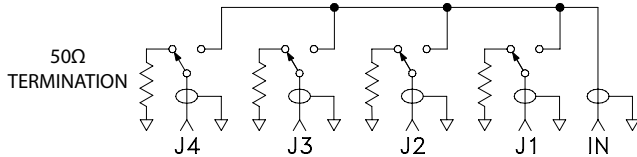

CONNECTIONS

Port Name	Connector Type
RF Switch A & B (COM & 1-4 each)	2.4 mm female
USB	USB type-B
Ethernet / LAN	RJ45
24V DC Input	2.1mm center positive DC socket

OUTLINE DRAWING (MR2616)

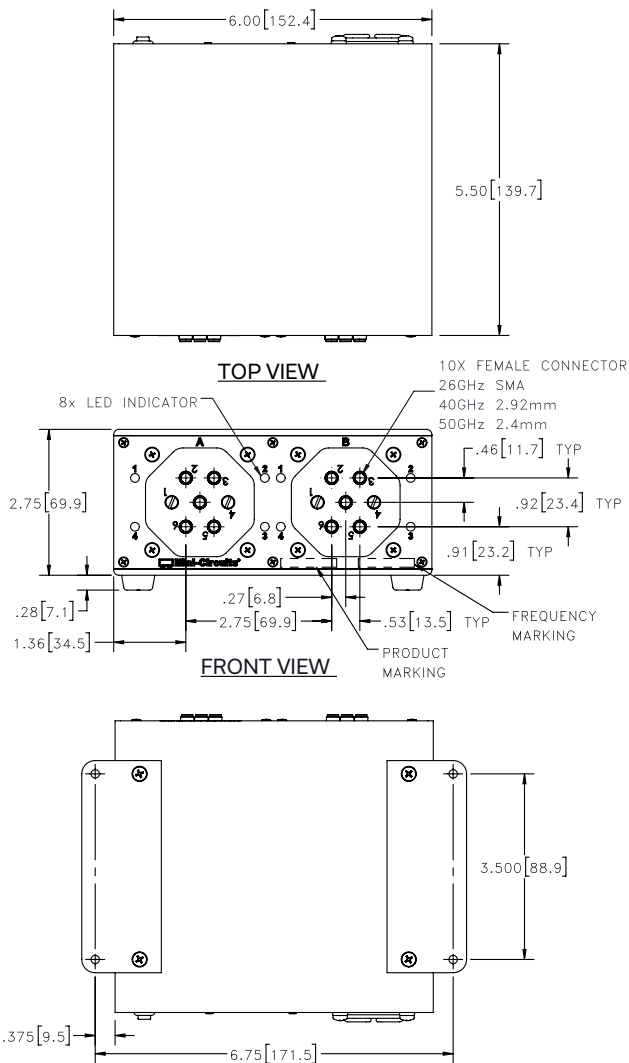

SHOWN WITH RUBBER FEET REMOVED AND BRACKETS INSTALLED.

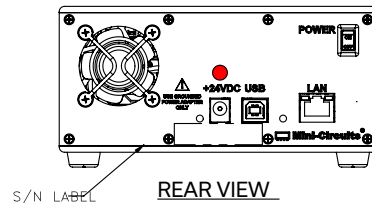

BRACKET OPTION

ONE SET OF 2 EACH

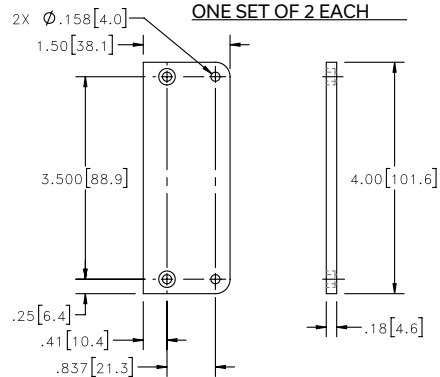

INSTRUCTIONS FOR MOUNTING BRACKETS:

- TOOL REQUIRED: PHILLIPS HEAD SCREWDRIVER
- STEP 1: REMOVE RUBBER FEET FROM THE BOTTOM OF THE UNIT. DO NOT DISCARD THE FASTENERS.
- STEP 2: MOUNT THE BRACKETS WITH THE FASTENERS REMOVED IN STEP 1, USING THE COUNTER BORE HOLES IN THE BRACKET.

Weight: 1290 grams.

Dimensions are in inches [mm]. Tolerances: 2 Pl.±.03 inch; 3 Pl.±.015 inch.





USB & ETHERNET CONTROLLED

Millimeter Wave Switch Matrix **RC-2SP4T-50**

Mini-Circuits

50Ω DC to 50 GHz 2.4 mm-Female

TYPICAL PERFORMANCE DATA (PER SWITCH)

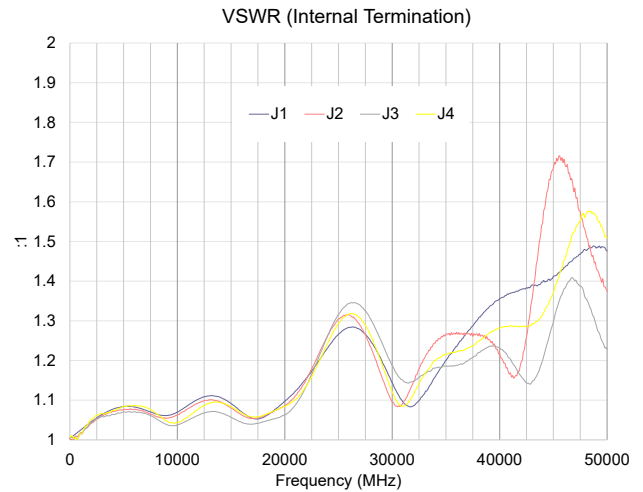
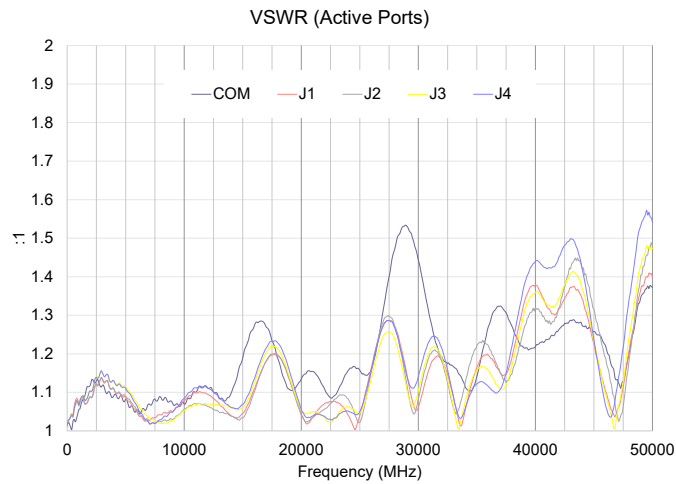
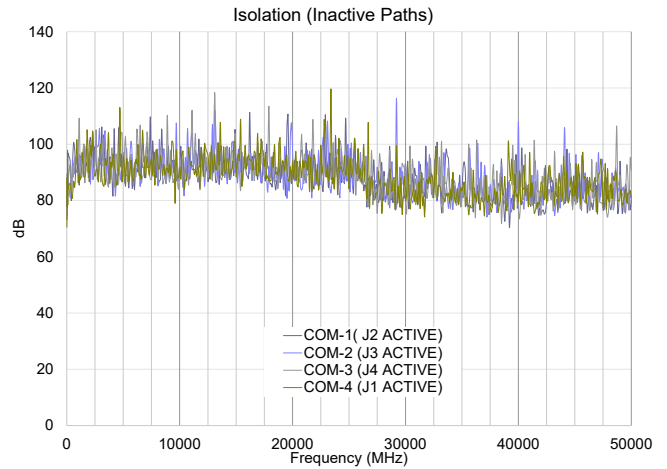
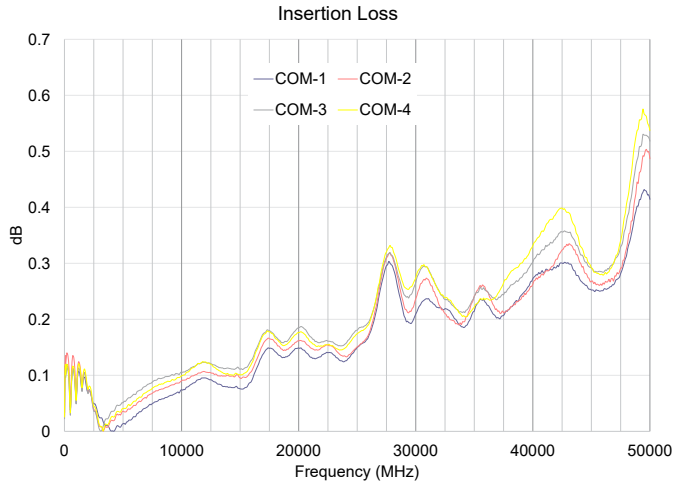



SOFTWARE SPECIFICATIONS

SOFTWARE & DOCUMENTATION DOWNLOAD:

- Mini-Circuits' full software and support package including user guide, Windows GUI, DLL files, programming manual and examples can be downloaded free of charge from: <https://www.minicircuits.com/softwaredownload/rfswitchcontroller.html>
- Please contact testsolutions@minicircuits.com for support

MINIMUM SYSTEM REQUIREMENTS:

Parameter	Requirements	
Interface	USB HID & Ethernet (HTTP & Telnet)	
System Requirements	GUI	Windows 98 or later
	USB API DLL	Windows 98 or later and programming environment with ActiveX or .NET support
	USB Direct Programming	Linux, Windows 98 or later
	Ethernet	Windows, Linux or Mac computer with a network port and Ethernet TCP/IP support
Hardware	Pentium II or later with 256 MB RAM	

APPLICATION PROGRAMMING INTERFACE (API)

ETHERNET SUPPORT:

- Simple ASCII / SCPI command set for attenuator control
- Communication via HTTP or Telnet
- Supported by most common programming environment

USB SUPPORT (WINDOWS):

- ActiveX COM DLL file for creation of 32-bit programs
- .NET library DLL file for creation of 32 / 64-bit programs
- Supported by most common programming environments (refer to application note AN-49-001 for summary of supported environments)

USB SUPPORT (LINUX):

- Direct USB programming using a series of USB interrupt codes

Full programming instructions and examples available for a wide range of programming environments / languages.



USB & ETHERNET CONTROLLED

Millimeter Wave Switch Matrix **RC-2SP4T-50**

50Ω DC to 50 GHz 2.4 mm-Female

GRAPHICAL USER INTERFACE (GUI) FOR WINDOWS - KEY FEATURES

- Connect via USB or Ethernet
- Run GUI in "demo mode" to evaluate software without a hardware connection

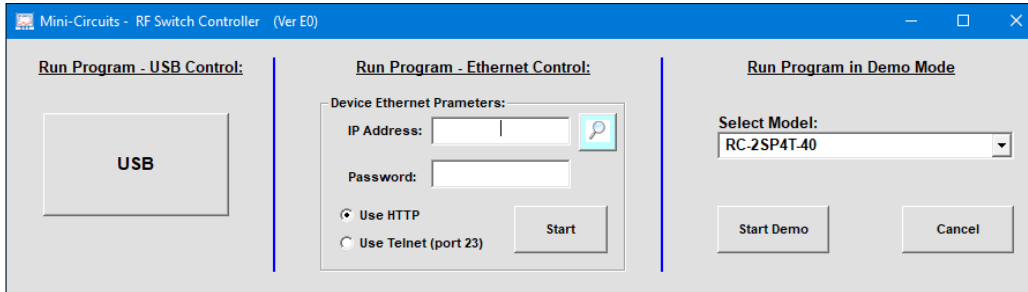

- View and set switch states at the click of a button
- Configure and run timed switching sequences
- Set start-up switch state
- Configure Ethernet IP settings

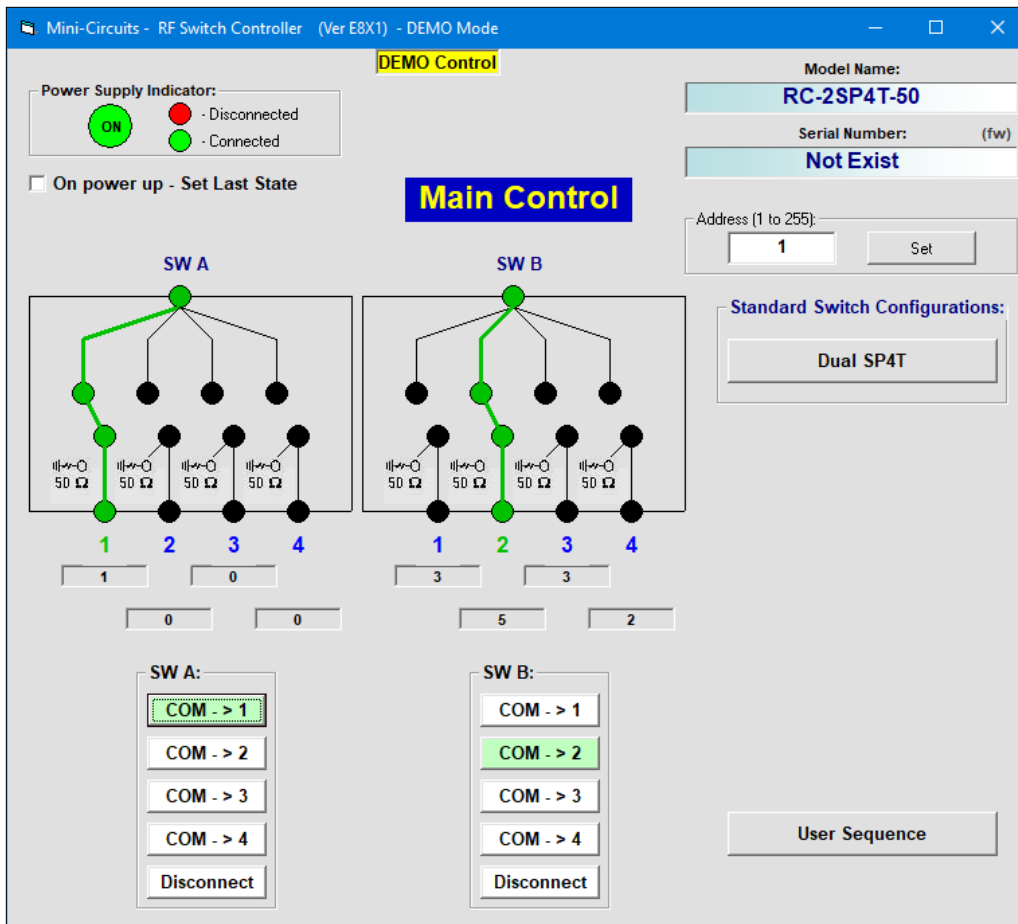



USB & ETHERNET CONTROLLED



Millimeter Wave Switch Matrix **RC-2SP4T-50**





50Ω DC to 50 GHz 2.4 mm-Female

ORDERING INFORMATION

Please contact Mini-Circuits' Test Solutions department for price and availability: testsolutions@minicircuits.com

Model	Description
RC-2SP4T-50	USB & Ethernet controlled SP4T switch matrix

Included Accessories	Part No.	Description
	AC/DC-24-3W1	AC/DC 24V _{DC} Grounded Power Adaptor. Operating temperature: 0°C to +40°C, I _{Max} =2.5A
See Below	CBL-3W1-XX	AC Power Cord (Select one power cord from below with each Switch Matrix box)
	USB-CBL-AB-3+	2.7 ft (0.8 m) USB Cable: USB type A(Male) to USB type B(Male)

AC Power Cords ³	Part No.	Description
	CBL-3W1-US	Power Cord for United States
	CBL-3W1-EU	Power Cord for Europe
	CBL-3W1-UK	Power Cord for United Kingdom
	CBL-3W1-AU	Power Cord for Australia and China
	CBL-3W1-IL	Power Cord for Israel

3. If you need a Power cord for a country not listed please contact testsolutions@minicircuits.com

OPTIONAL ACCESSORIES

USB-CBL-AB-3+	2.7 ft (0.8 m) USB Cable: USB type A(Male) to USB type B(Male)
USB-CBL-AB-7+	6.8 ft (2.1 m) USB Cable: USB type A(Male) to USB type B(Male)
USB-CBL-AB-11+	11 ft (3.4 m) USB Cable: USB type A(Male) to USB type B(Male)

- NOTES**
- A. Performance and quality attributes and conditions not expressly stated in this specification document are intended to be excluded and do not form a part of this specification document.
 - B. Electrical specifications and performance data contained in this specification document are based on Mini-Circuit's applicable established test performance criteria and measurement instructions.
 - C. The parts covered by this specification document are subject to Mini-Circuits standard limited warranty and terms and conditions (collectively, "Standard Terms"); Purchasers of this part are entitled to the rights and benefits contained therein. For a full statement of the standard. Terms and the exclusive rights and remedies thereunder, please visit Mini-Circuits' website at www.minicircuits.com/MCLStore/terms.jsp



Typical Performance Data per Switch

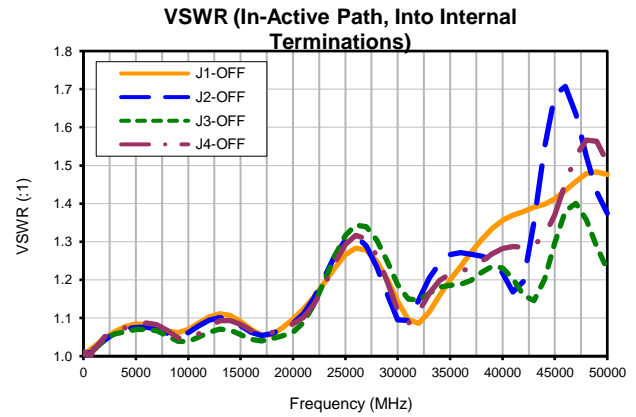
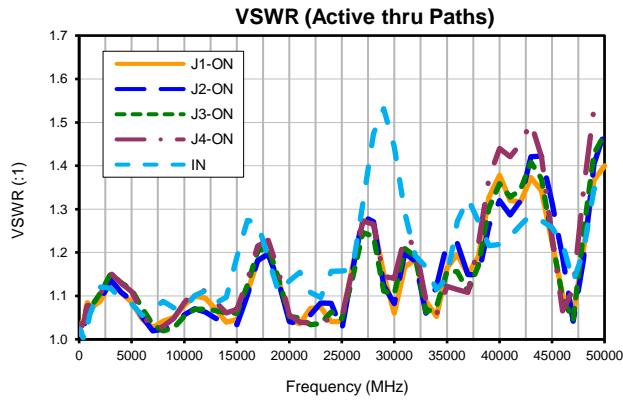
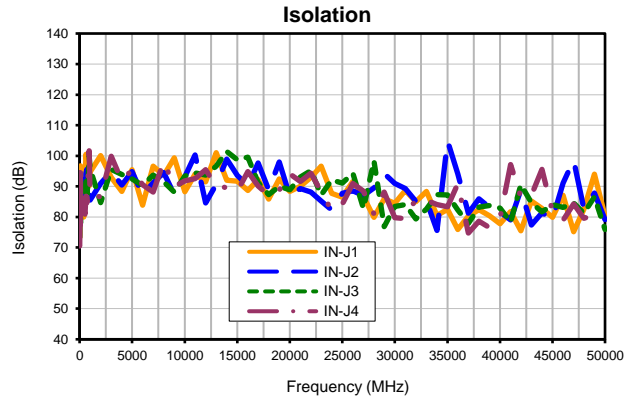
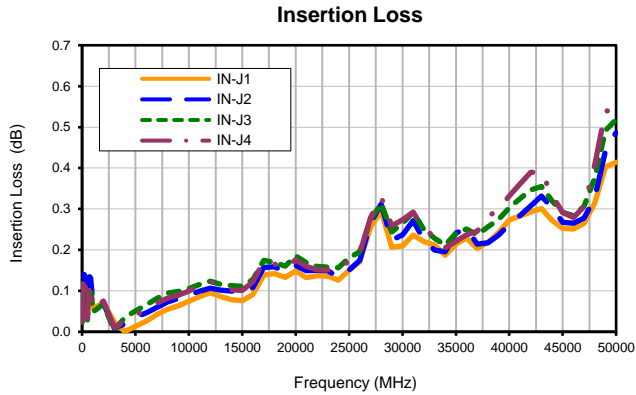

Outline Dimensions

MR2616

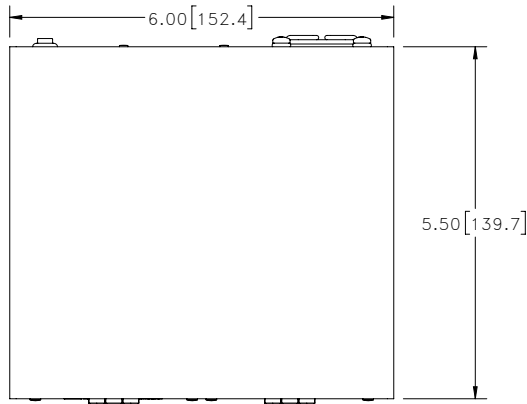

TOP VIEW

10X FEMALE CONNECTOR
26GHz SMA
40GHz 2.92mm
50GHz 2.4mm

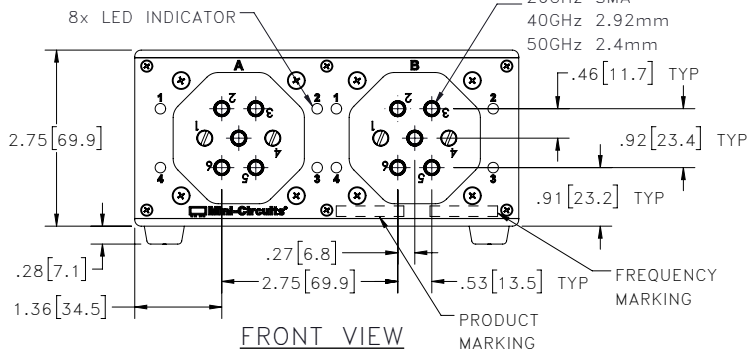

FRONT VIEW

PRODUCT MARKING

FREQUENCY MARKING

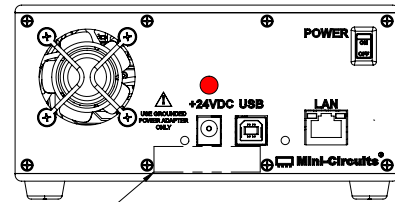

REAR VIEW

S/N LABEL

BRACKET OPTION

ONE SET OF 2 EACH

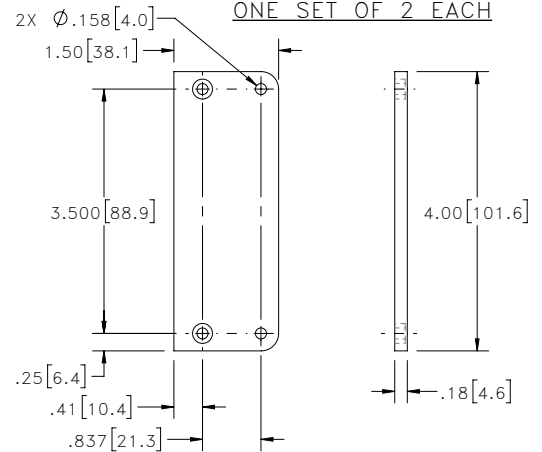

TOLERANCE: ±.005

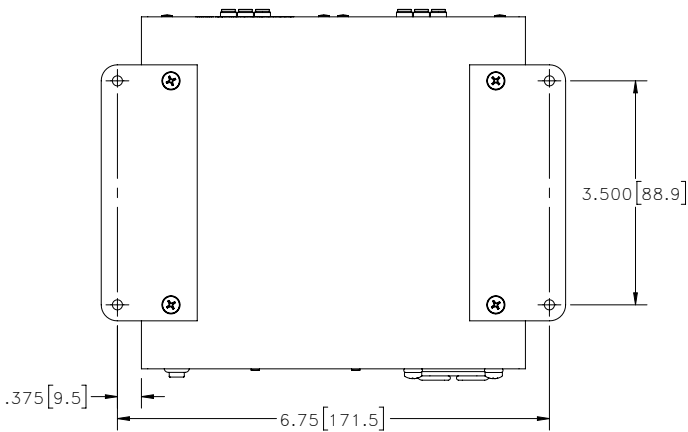

BOTTOM VIEW

SHOWN WITH RUBBER FEET REMOVED AND BRACKETS INSTALLED.

Notes:

1. Case material: Aluminum (with protective coating to prevent corrosion).
2. Dimensions are in inches [mm]. Tolerances: 2 Pl. ±.03 inch; 3 Pl. ±.015 inch.
3. Weight: 1290 grams.
4. Marking may contain other features or characters for internal lot control.

INSTRUCTIONS FOR MOUNTING BRACKETS:

TOOL REQUIRED: PHILLIPS HEAD SCREWDRIVER

- STEP 1: REMOVE RUBBER FEET FROM THE BOTTOM OF THE UNIT. DO NOT DISCARD THE FASTENERS.
- STEP 2: MOUNT THE BRACKETS WITH THE FASTENERS REMOVED IN STEP 1, USING THE COUNTER BORE HOLES IN THE BRACKET.



P.O. Box 350166, Brooklyn, New York 11235-0003 (718) 934-4500 Fax (718) 332-4661 For detailed performance specs & shopping online see Mini-Circuits web site



The Design Engineers Search Engine Provides ACTUAL Data Instantly From MINI-CIRCUITS At: www.minicircuits.com

RF/IF MICROWAVE COMPONENTS



All Mini-Circuits products are manufactured under exacting quality assurance and control standards, and are capable of meeting published specifications after being subjected to any or all of the following physical and environmental test.

Specification	Test/Inspection Condition	Reference/Spec
Operating Temperature	0° to 40° C Ambient Environment	Individual Model Data Sheet
Storage Temperature	-15° to 85°C Ambient Environment	Individual Model Data Sheet
Operating and Storage Humidity	5% to 85% RH (non-condensing)	Ambient
Bench Handling Test	Bench Top Tip 45° & Drop	MIL-PRF-28800F
Transit Drop Test	Free Fall Drop, 20 cm (7.9 inches)	MIL-PRF-28800F class 3