

# Surface Mount Bandpass Filter

## RBP-188+

50Ω 138 to 238 MHz



Generic photo used for illustration purposes only  
CASE STYLE: GP731

### The Big Deal

- Low insertion loss
- Broader bandwidth
- High Rejection
- Miniature shielded package

### Product Overview

The RBP-188+ is a broad band filter in a small shielded package (size of 0.35" x 0.35" x 0.10") fabricated using SMT technology. This filter offers outstanding close in rejection, low insertion loss for use in mobile networks and digital television.

### Key Features

Feature	Advantages
High Rejection	RBP-188+ enables the filter to attenuate spurious signals and rejects harmonics for broad band of frequency.
Low Passband VSWR	This filter maintains typical VSWR over passband frequency range making this filter easier to integrate into receiver and transmitter RF chains with less concerns for in band frequency ripple.
Small size, 0.35" x 0.35" x 0.10"	The unique surface mount package enables the RBP-188+ to be used in compact design.

#### Notes

- A. Performance and quality attributes and conditions not expressly stated in this specification document are intended to be excluded and do not form a part of this specification document.  
B. Electrical specifications and performance data contained in this specification document are based on Mini-Circuit's applicable established test performance criteria and measurement instructions.  
C. The parts covered by this specification document are subject to Mini-Circuits standard limited warranty and terms and conditions (collectively, "Standard Terms"); Purchasers of this part are entitled to the rights and benefits contained therein. For a full statement of the Standard Terms and the exclusive rights and remedies thereunder, please visit Mini-Circuits' website at [www.minicircuits.com/MCLStore/terms.jsp](http://www.minicircuits.com/MCLStore/terms.jsp)



# Surface Mount Bandpass Filter

## RBP-188+

50Ω 138 to 238 MHz



Generic photo used for illustration purposes only  
CASE STYLE: GP731

### Features

- Broader bandwidth
- Low insertion loss
- High rejection
- Miniature shielded package

### Applications

- Auxiliary broadcasting
- Biomedical telemetry devices
- Private and public land mobile
- Digital television

### Electrical Specifications at 25°C

Parameter	F#	Frequency (MHz)	Min.	Typ.	Max.	Unit	
Pass Band	Center Frequency	—	—	188	—	MHz	
	Insertion Loss	F1-F2	138-238	—	1.80	3.00	dB
	VSWR	F1-F2	138-238	—	1.38	1.92	:1
Stop Band, Lower	Insertion Loss	DC-F3	DC-96	20	27	—	dB
	VSWR	DC-F3	DC-96	—	20	—	:1
Stop Band, Upper	Insertion Loss	F4-F5	315-3600	20	25	—	dB
	VSWR	F4-F5	315-3600	—	20	—	:1

### Maximum Ratings

Operating Temperature	-40°C to 85°C
Storage Temperature	-55°C to 100°C
RF Power Input	0.25 W

Permanent damage may occur if any of these limits are exceeded.

### Functional Schematic

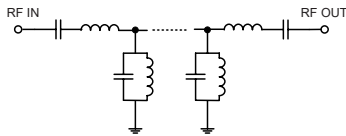

### Typical Performance Data at 25°C

Frequency (MHz)	Insertion Loss (dB)	VSWR (:1)	Frequency (MHz)	Group Delay (nsec)
1	90.54	17371.78	138	14.15
70	50.37	144.77	140	13.47
92	31.06	48.26	142	12.88
96	27.49	38.61	146	11.92
104	20.16	22.00	155	10.48
112	12.69	10.62	160	9.95
120	6.15	4.01	168	9.30
126	3.28	2.04	173	8.97
138	1.70	1.16	178	8.69
188	1.32	1.34	183	8.46
238	1.73	1.26	188	8.29
252	3.14	2.20	193	8.19
263	6.73	5.27	198	8.17
278	13.48	13.60	203	8.20
296	20.81	24.48	225	8.82
315	27.14	34.07	228	8.99
325	30.00	37.77	230	9.13
500	55.97	72.39	234	9.51
2000	75.06	31.60	236	9.75
3600	38.61	28.96	238	10.03

### Typical Frequency Response

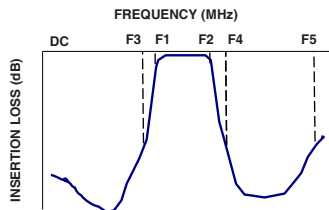

**+RoHS Compliant**  
The +Suffix identifies RoHS Compliance. See our web site for RoHS Compliance methodologies and qualifications

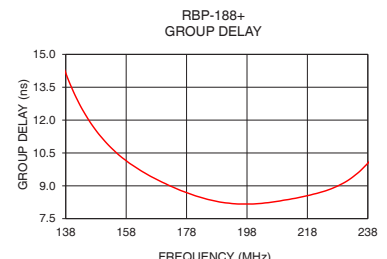
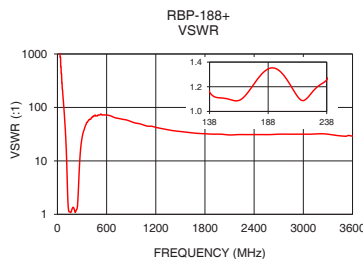
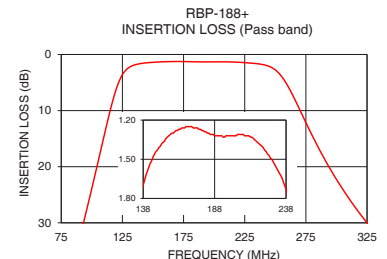
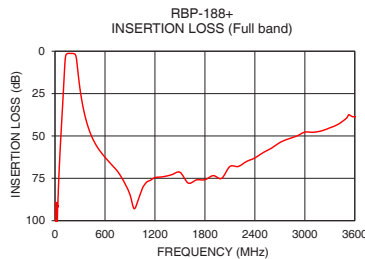

### Notes

- Performance and quality attributes and conditions not expressly stated in this specification document are intended to be excluded and do not form a part of this specification document.
- Electrical specifications and performance data contained in this specification document are based on Mini-Circuit's applicable established test performance criteria and measurement instructions.
- The parts covered by this specification document are subject to Mini-Circuits standard limited warranty and terms and conditions (collectively, "Standard Terms"); Purchasers of this part are entitled to the rights and benefits contained therein. For a full statement of the Standard Terms and the exclusive rights and remedies thereunder, please visit Mini-Circuits' website at [www.minicircuits.com/MCLStore/terms.jsp](http://www.minicircuits.com/MCLStore/terms.jsp)



[www.minicircuits.com](http://www.minicircuits.com) P.O. Box 350166, Brooklyn, NY 11235-0003 (718) 934-4500 sales@minicircuits.com

REV. C  
ECO-005139  
RBP-188+  
EDU1864  
URJ  
201128  
Page 2 of 3

## Pad Connections

INPUT	2
OUTPUT	6
GROUND	1,3,4,5,7,8

**Demo Board MCL P/N: TB-332**  
**Suggested PCB Layout (PL-176)**

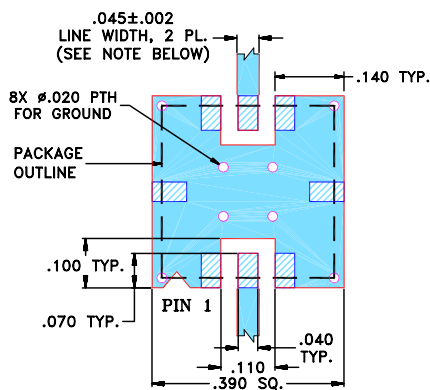

- NOTES:**
- TRACE WIDTH IS SHOWN FOR FR4 WITH DIELECTRIC THICKNESS .025" ± .002"; COPPER: 1/2 OZ. EACH SIDE. FOR OTHER MATERIALS TRACE WIDTH MAY NEED TO BE MODIFIED.
  - BOTTOM SIDE OF THE PCB IS CONTINUOUS GROUND PLANE.

- DENOTES PCB COPPER LAYOUT WITH SMOBC (SOLDER MASK OVER BARE COPPER)
- DENOTES COPPER LAND PATTERN FREE OF SOLDER MASK

## Outline Drawing

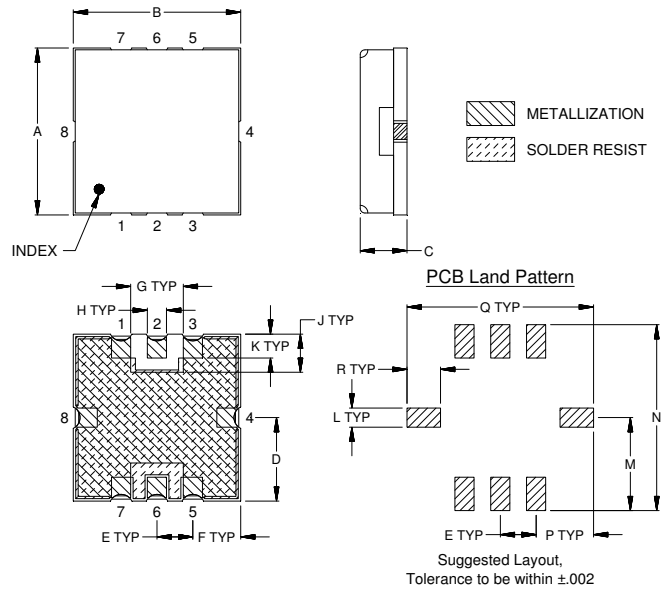

## Outline Dimensions (Inch/mm)

A	B	C	D	E	F	G	H	J
.350	.350	.100	.175	.075	.100	.110	.040	.080
8.89	8.89	2.54	4.45	1.91	2.54	2.79	1.02	2.03
K	L	M	N	P	Q	R	wt	
.050	.040	.195	.390	.120	.390	.070	grams	
1.27	1.02	4.95	9.91	3.05	9.91	1.78	0.25	

Note: Please refer to case style drawing for details

### Notes

- Performance and quality attributes and conditions not expressly stated in this specification document are intended to be excluded and do not form a part of this specification document.
- Electrical specifications and performance data contained in this specification document are based on Mini-Circuit's applicable established test performance criteria and measurement instructions.
- The parts covered by this specification document are subject to Mini-Circuits standard limited warranty and terms and conditions (collectively, "Standard Terms"); Purchasers of this part are entitled to the rights and benefits contained therein. For a full statement of the Standard Terms and the exclusive rights and remedies thereunder, please visit Mini-Circuits' website at [www.minicircuits.com/MCLStore/terms.jsp](http://www.minicircuits.com/MCLStore/terms.jsp)

## Typical Performance Data

FREQ.  (MHz)	INSERTION LOSS			INPUT RETURN LOSS			OUTPUT RETURN LOSS		
	(dB)			(dB)			(dB)		
	@-40°C	@+25°C	@+85°C	@-40°C	@+25°C	@+85°C	@-40°C	@+25°C	@+85°C
1	86.52	90.54	93.66	0.00	0.00	0.00	0.00	0.00	0.00
20	107.40	110.66	112.25	0.00	0.01	0.00	0.00	0.01	0.01
48	71.98	72.02	71.70	0.03	0.04	0.04	0.03	0.04	0.04
76	45.21	45.02	44.90	0.13	0.16	0.17	0.12	0.15	0.16
94	29.46	29.28	29.11	0.34	0.40	0.43	0.32	0.38	0.41
96	27.67	27.49	27.32	0.39	0.45	0.49	0.37	0.43	0.47
100	24.03	23.86	23.68	0.50	0.59	0.63	0.48	0.56	0.61
104	20.31	20.16	19.99	0.68	0.79	0.84	0.65	0.75	0.82
106	18.43	18.29	18.12	0.80	0.92	0.99	0.77	0.89	0.97
108	16.53	16.41	16.25	0.96	1.10	1.18	0.93	1.06	1.16
116	9.16	9.16	9.08	2.37	2.63	2.81	2.33	2.60	2.82
126	3.10	3.28	3.36	8.84	9.34	9.71	9.01	9.60	10.07
138	1.52	1.70	1.81	21.52	22.76	23.11	22.63	24.38	24.75
150	1.24	1.40	1.49	24.34	25.87	26.44	24.12	25.19	25.36
160	1.13	1.29	1.38	27.08	27.69	28.19	28.79	29.00	29.39
165	1.11	1.26	1.35	26.55	26.61	26.59	30.18	29.52	29.29
171	1.10	1.25	1.34	22.37	22.75	22.64	24.12	24.48	24.22
185	1.17	1.31	1.39	16.28	17.08	17.29	16.69	17.54	17.69
188	1.18	1.32	1.40	15.83	16.66	16.93	16.15	17.02	17.22
191	1.19	1.32	1.41	15.63	16.48	16.81	15.86	16.75	17.00
212	1.16	1.32	1.42	23.33	23.91	24.51	21.47	21.94	22.14
218	1.19	1.37	1.47	28.48	27.51	26.61	23.79	23.84	23.48
228	1.32	1.50	1.62	21.16	21.61	21.16	21.18	22.40	22.47
230	1.35	1.54	1.66	20.33	20.86	20.52	20.99	22.52	22.81
238	1.51	1.73	1.88	19.04	18.90	18.40	24.98	28.20	29.23
248	2.09	2.45	2.69	12.62	11.68	11.06	15.31	13.86	13.07
254	3.15	3.61	3.93	7.60	7.19	6.86	8.50	8.01	7.64
258	4.33	4.81	5.18	5.25	5.09	4.90	5.76	5.56	5.37
274	11.31	11.68	12.02	1.45	1.57	1.60	1.56	1.67	1.70
276	12.24	12.59	12.91	1.29	1.41	1.45	1.39	1.50	1.54
294	19.86	20.07	20.28	0.64	0.74	0.79	0.67	0.77	0.81
296	20.61	20.81	21.02	0.60	0.71	0.75	0.63	0.73	0.78
315	26.98	27.14	27.27	0.42	0.51	0.55	0.43	0.52	0.56
325	29.85	30.00	30.10	0.37	0.46	0.49	0.38	0.46	0.50
355	37.02	37.16	37.20	0.27	0.34	0.38	0.28	0.35	0.39
505	56.33	56.36	56.33	0.16	0.24	0.27	0.16	0.25	0.28
750	70.93	70.84	71.14	0.16	0.28	0.32	0.16	0.27	0.31
980	88.74	87.89	87.97	0.21	0.34	0.39	0.20	0.33	0.39
1100	77.59	77.27	77.55	0.24	0.39	0.44	0.22	0.37	0.42
1175	74.30	74.66	74.86	0.25	0.41	0.46	0.24	0.39	0.45
1525	69.71	70.17	70.59	0.32	0.49	0.55	0.30	0.46	0.53
1625	76.21	77.51	77.95	0.33	0.51	0.56	0.32	0.48	0.55
1850	71.41	72.17	72.06	0.36	0.54	0.59	0.35	0.51	0.58
2000	75.54	75.06	74.32	0.37	0.55	0.60	0.36	0.53	0.59
2100	68.96	68.00	67.04	0.39	0.57	0.61	0.37	0.53	0.59
2225	71.20	69.84	67.98	0.38	0.56	0.60	0.37	0.53	0.59
2350	62.58	62.49	61.68	0.38	0.56	0.60	0.36	0.54	0.59
2450	65.90	65.97	64.31	0.38	0.56	0.60	0.36	0.53	0.58
2550	59.48	59.22	60.00	0.37	0.56	0.60	0.37	0.54	0.59
2750	55.85	55.76	55.57	0.36	0.55	0.59	0.36	0.54	0.58
3025	46.66	46.56	47.19	0.35	0.55	0.61	0.36	0.55	0.61
3150	48.66	48.33	48.35	0.33	0.54	0.60	0.34	0.54	0.60
3200	47.07	47.01	47.72	0.33	0.54	0.60	0.35	0.55	0.62
3300	45.66	45.21	43.91	0.33	0.55	0.62	0.34	0.55	0.62
3550	38.67	38.03	37.74	0.33	0.58	0.68	0.36	0.59	0.70
3500	38.88	39.51	41.34	0.36	0.60	0.67	0.39	0.61	0.67
3525	37.51	37.53	38.42	0.35	0.60	0.70	0.37	0.61	0.70
3550	38.67	38.03	37.74	0.33	0.58	0.68	0.36	0.59	0.70
3575	39.20	38.65	38.16	0.34	0.59	0.68	0.37	0.60	0.70
3600	38.96	38.61	38.31	0.35	0.60	0.70	0.37	0.60	0.69

*Typical Performance Data*

FREQ.  (MHz)	GROUP DELAY		
	(nsec)		
	@-40°C	@+25°C	@+85°C
138	14.27	14.15	14.05
141	13.25	13.16	13.09
142	12.96	12.88	12.81
145	12.20	12.14	12.09
146	11.98	11.92	11.87
147	11.77	11.72	11.68
149	11.40	11.35	11.32
150	11.23	11.19	11.15
152	10.92	10.88	10.85
153	10.78	10.74	10.72
154	10.64	10.61	10.58
155	10.52	10.48	10.46
157	10.28	10.25	10.23
160	9.98	9.95	9.93
161	9.88	9.86	9.84
162	9.80	9.77	9.75
164	9.63	9.60	9.58
166	9.47	9.44	9.43
167	9.40	9.37	9.36
170	9.19	9.16	9.15
171	9.12	9.10	9.08
174	8.93	8.91	8.90
176	8.80	8.79	8.79
178	8.69	8.69	8.68
181	8.54	8.54	8.54
182	8.49	8.50	8.50
184	8.40	8.42	8.42
185	8.36	8.38	8.39
188	8.26	8.29	8.30
189	8.24	8.26	8.28
190	8.21	8.24	8.26
193	8.16	8.19	8.21
195	8.14	8.17	8.20
196	8.13	8.17	8.19
201	8.15	8.18	8.21
202	8.16	8.19	8.22
206	8.23	8.25	8.28
207	8.25	8.27	8.30
209	8.30	8.31	8.34
210	8.32	8.34	8.36
211	8.34	8.36	8.38
212	8.37	8.38	8.41
213	8.40	8.41	8.43
214	8.42	8.43	8.46
215	8.45	8.46	8.48
216	8.48	8.49	8.51
217	8.51	8.52	8.54
218	8.54	8.55	8.57
219	8.57	8.58	8.61
220	8.60	8.62	8.64
221	8.63	8.65	8.68
224	8.74	8.77	8.81
225	8.78	8.82	8.86
228	8.93	8.99	9.04
230	9.06	9.13	9.19
232	9.22	9.30	9.37
234	9.41	9.51	9.58
235	9.53	9.62	9.71
236	9.65	9.75	9.84
238	9.93	10.03	10.12

## Typical Performance Curves

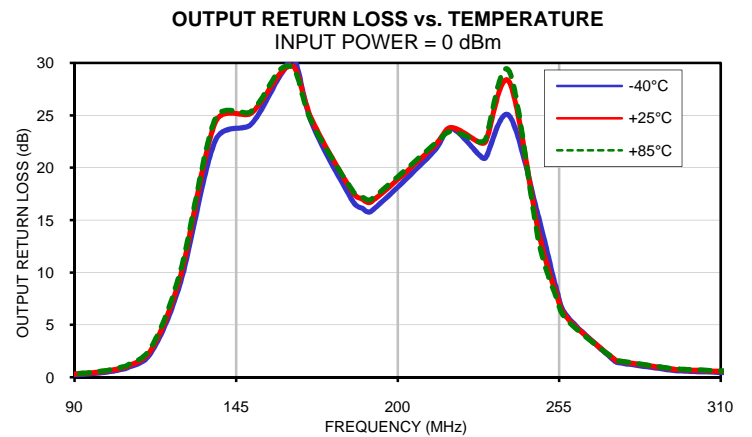
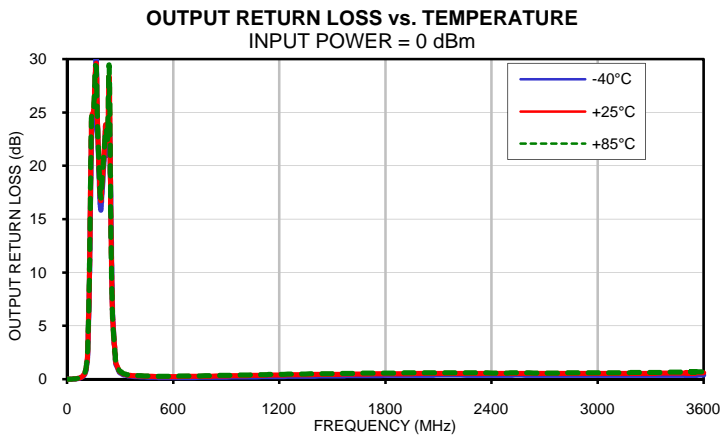
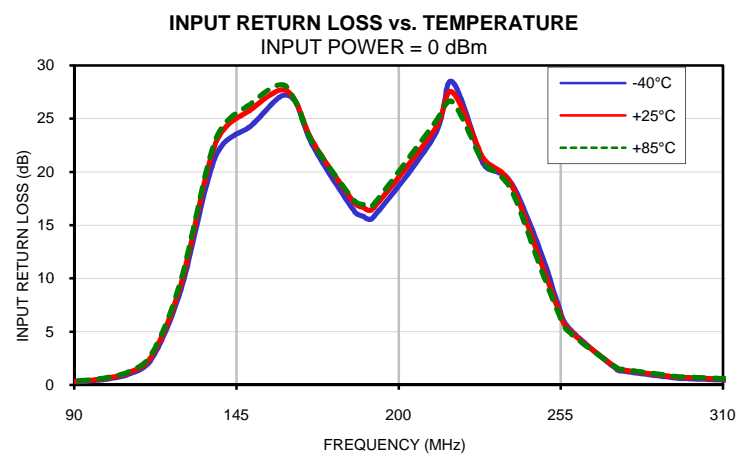
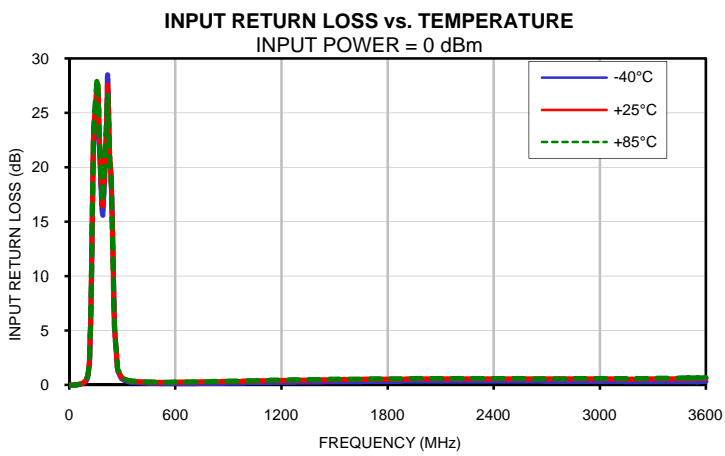
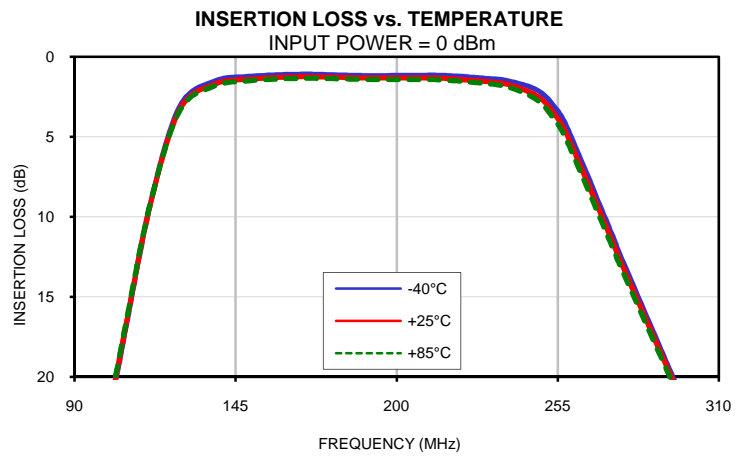
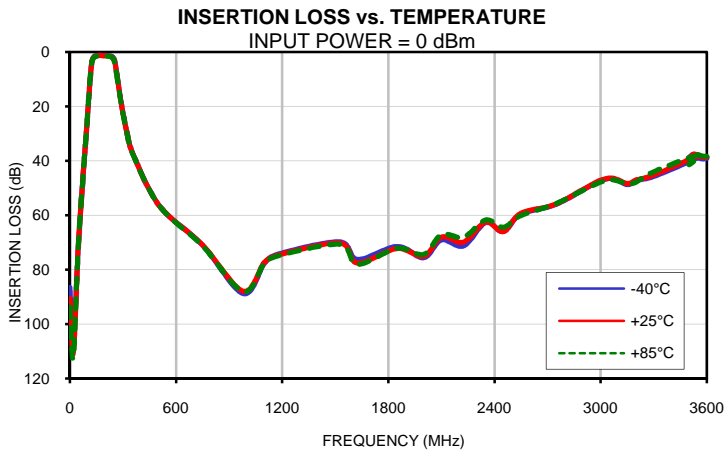

## Typical Performance Curves

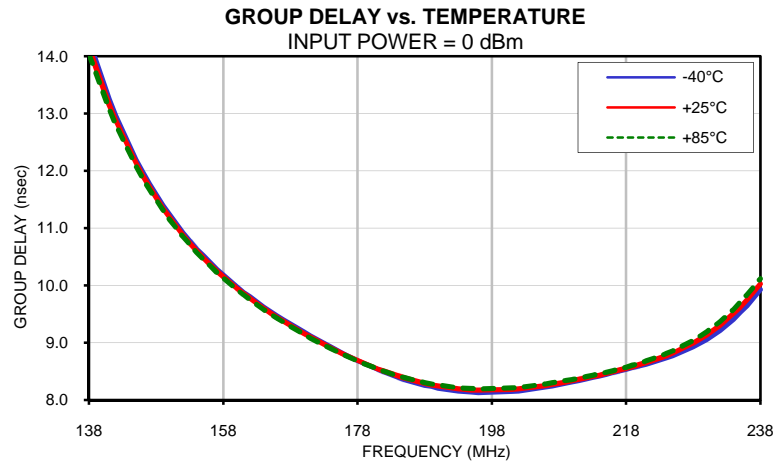

## Outline Dimensions

## GP731

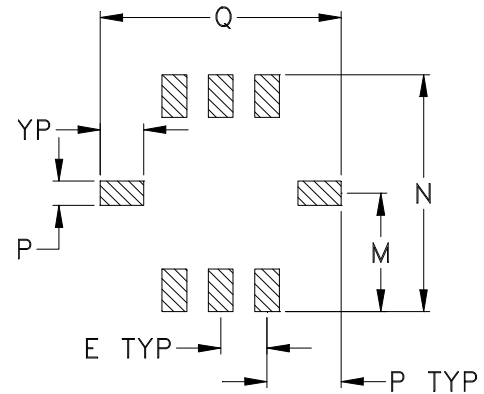
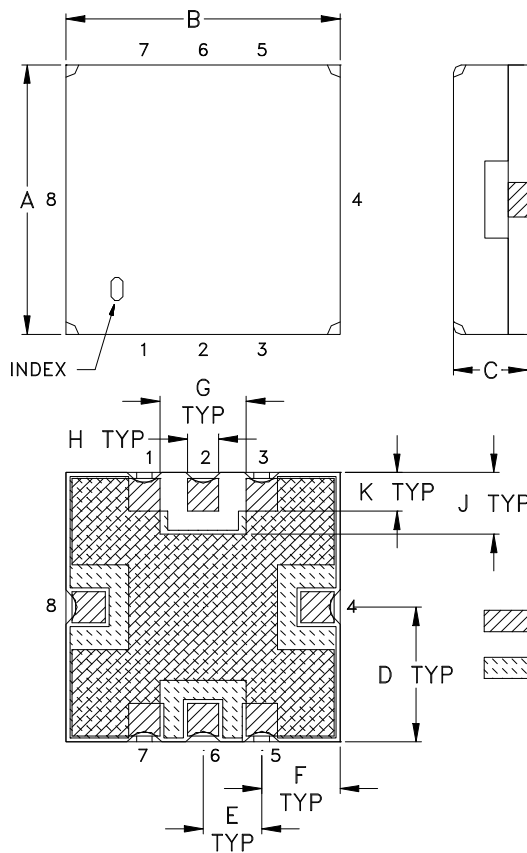

CASE #	A	B	C	D	E	F	G	H	J	K	L	M
GP731	.350 (8.89)	.350 (8.89)	.100 (2.54)	.175 (4.45)	.075 (1.91)	.100 (2.54)	.110 (2.79)	.040 (1.02)	.080 (2.03)	.050 (1.27)	.040 (1.02)	.195 (4.95)

CASE #	N	P	Q	R	WT. GRAM
GP731	.390 (9.91)	.120 (3.05)	.390 (9.91)	.070 (1.78)	.4 +0.3 -0.0

Dimensions are in inches (mm). Tolerances: 2 Pl.  $\pm .03$ ; 3Pl.  $\pm .015$

### Notes:

- Case material: Nickel-Silver alloy.
- Base: Printed wiring laminate.
- Termination finish:
  - For RoHS Case Styles: 3-5  $\mu$  inch (.08-.13 microns) Gold over 120-240  $\mu$  inch (3.05-6.10 microns) Nickel plate.
  - For RoHS-5 Case Styles: Tin-Lead plate.

**Mini-Circuits®**  
ISO 9001 ISO 14001 CERTIFIED

ALL NEW  
minicircuits.com

P.O. Box 350166, Brooklyn, New York 11235-0003 (718) 934-4500 Fax (718) 332-4661 For detailed performance specs & shopping online see Mini-Circuits web site



The Design Engineers Search Engine Provides ACTUAL Data Instantly From MINI-CIRCUITS At: [www.minicircuits.com](http://www.minicircuits.com)

RF/IF MICROWAVE COMPONENTS



# Tape & Reel Packaging TR-F78

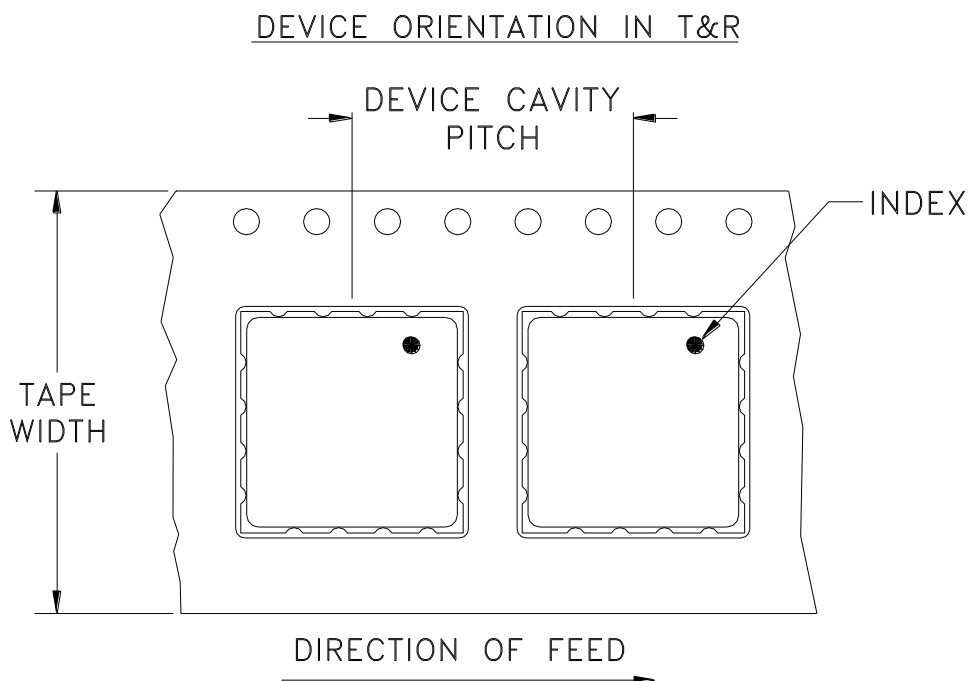

Tape Width, mm	Device Cavity Pitch, mm	Reel Size, inches	Devices per Reel see note
16	12	7	10
			20
			50
			100
			200
		13	500, 1000

Note: Please consult individual model data sheet to determine device per reel availability.

Mini-Circuits carrier tape materials provide protection from ESD (Electro-Static Discharge) during handling and transportation. Tapes are static dissipative and comply with industry standards EIA-481/EIA-541.

Go to: [www.minicircuits.com/pages/pdfs/tape.pdf](http://www.minicircuits.com/pages/pdfs/tape.pdf)



INTERNET <http://www.minicircuits.com>

P.O. Box 350166, Brooklyn, New York 11235-0003 (718) 934-4500 Fax (718) 332-4661

Distribution Centers NORTH AMERICA 800-654-7949 • 417-335-5935 • Fax 417-335-5945 • EUROPE 44-1252-832600 • Fax 44-1252-837010

Mini-Circuits ISO 9001 & ISO 14001 Certified

THIRD ANGLE PROJECTION

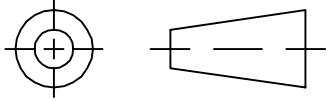

REVISIONS

REV	ECN No.	DESCRIPTION	DATE	DR	AUTH
OR	R59289	NEW RELEASE (FROM RAVON)	02/05	DK	HH
A	M101151	ADDED "RBP" & CORRECTED PIN CONNECTION TO DESCRIPTION OF PL-DWG.	10/10/05	MMG	DJ
B	M102713	UPDATED NOTES, ADDED "...WITH SMOBC"	01/20/06	GT	IL

**SUGGESTED MOUNTING CONFIGURATION FOR GP731 CASE STYLE, "qf" PIN CONNECTION.**

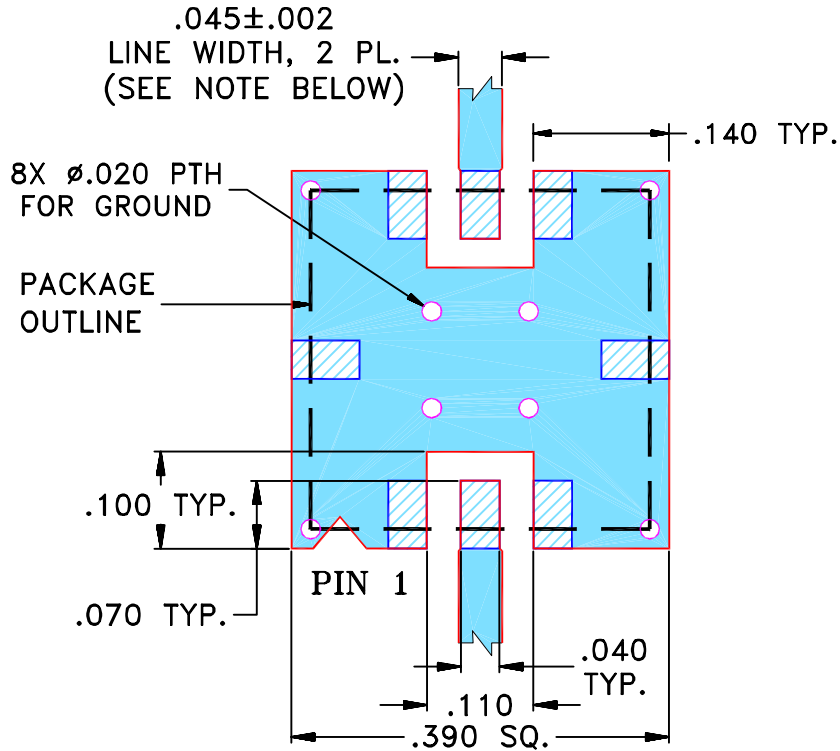

- NOTES:**
- TRACE WIDTH IS SHOWN FOR FR4 WITH DIELECTRIC THICKNESS .025" ± .002"; COPPER: 1/2 OZ. EACH SIDE. FOR OTHER MATERIALS TRACE WIDTH MAY NEED TO BE MODIFIED.
  - BOTTOM SIDE OF THE PCB IS CONTINUOUS GROUND PLANE.



DENOTES PCB COPPER LAYOUT WITH SMOBC (SOLDER MASK OVER BARE COPPER)



DENOTES COPPER LAND PATTERN FREE OF SOLDER MASK

UNLESS OTHERWISE SPECIFIED	INITIALS	DATE
DIMENSIONS ARE IN INCHES	DRAWN DK (RAVON)	10 FEB 05
TOLERANCES ON:	CHECKED RZ (RAVON)	10 FEB 05
2 PL DECIMALS ±	APPROVED HH (RAVON)	10 FEB 05
3 PL DECIMALS ± .005		
ANGLES ±		
FRACTIONS ±		



**Mini-Circuits®**

13 Neptune Avenue  
Brooklyn NY 11235

**PL, qf, GP731, RBP, TB-332**

Mini-Circuits®  
THIS DOCUMENT AND ITS CONTENTS ARE THE PROPERTY OF MINI-CIRCUITS. EXCEPT FOR USE EXPRESSLY GRANTED, IN WRITING, TO ITS VENDORS, VENDEE AND THE UNITED STATES GOVERNMENT, MINI-CIRCUITS RESERVES ALL PROPRIETARY DESIGN, USE, MANUFACTURING AND REPRODUCTION RIGHTS THERETO. THESE CONTENTS SHALL NOT BE USED, DUPLICATED OR DISCLOSED TO ANY OUTSIDE PARTY, IN WHOLE OR IN PART, WITHOUT WRITTEN PERMISSION OF MINI-CIRCUITS.

SIZE	CODE IDENT	DRAWING NO:	REV:
A	15542	98-PL-176	B
FILE:	98PL176	SCALE: 5:1	SHEET: 1 OF 1

# Evaluation Board and Circuit

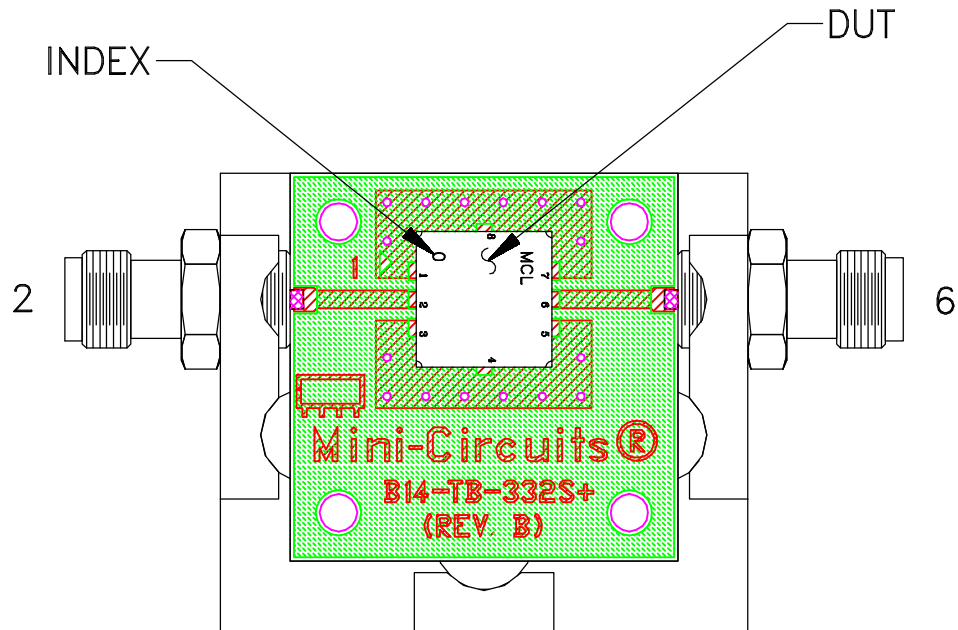

TB-332

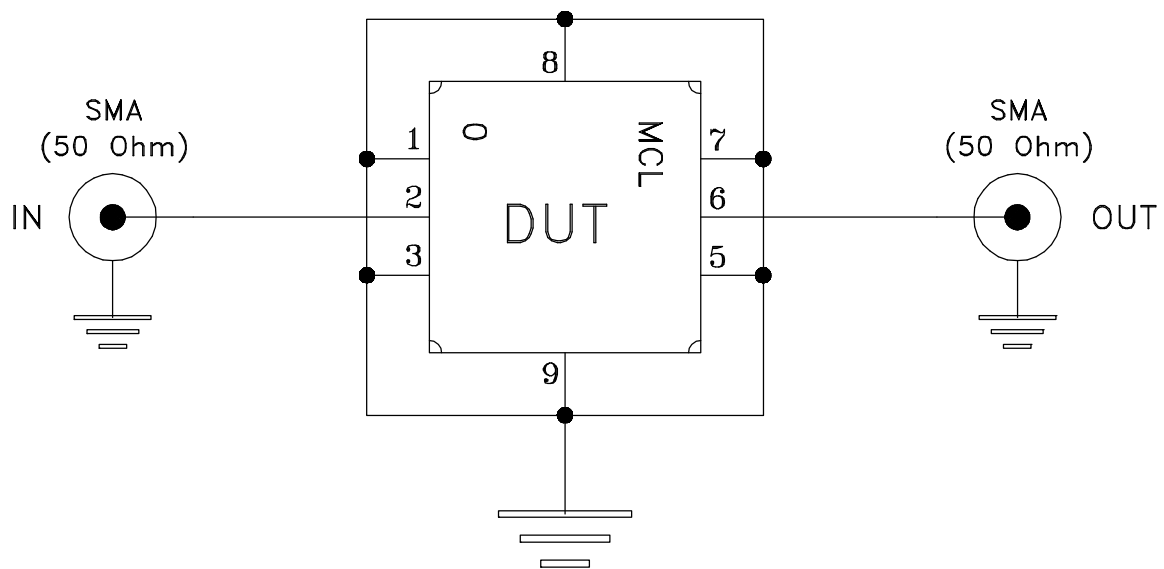

Schematic Diagram

## Notes:

1. 50 Ohm SMA Female connectors.
2. PCB Material: R04350 or equivalent,  
Dielectric Constant=3.5, Thickness=.020 inch.

 **Mini-Circuits®**

All Mini-Circuits products are manufactured under exacting quality assurance and control standards, and are capable of meeting published specifications after being subjected to any or all of the following physical and environmental test.

Specification	Test/Inspection Condition	Reference/Spec
Operating Temperature	-40° to 85° C Ambient Environment	Individual Model Data Sheet
Storage Temperature	-65° to 150° C Ambient Environment	Individual Model Data Sheet
Autoclave	15 psig, 100% RH, 121°C, 96 hours	JESD22-A102-C, Condition C
Temperature Cycling	-65° to 150°C, 100 cycles	JESD22-A104
Temperature Humidity	85°C/ 85% RH, 168 hours	JESD22-113
Solder Reflow Heat	Sn-Pb Eutetic Process: 240°C peak Pb-Free Process: 260°C peak	J-STD-020, Table 4-1, 4-2 and 5-2; Figure 5-1
Moisture Sensitivity: Level 1	Bake at 125°C for 24 hours Soak at 85°C/85% RH for 168 hours, Reflow 3 cycles at 240°C peak (Non-RoHS) or 260°C (RoHS)	J-STD-020
Solderability	10X magnification, 95% coverage	JESD22-B102, Method 1: Dip and Look Test
Mechanical Shock	50g, 11 ms, 1/2-sine, 18 shocks: 3 each direction, each of 3 axes	MIL-STD-202, Method 213, Condition A
Vibration (High Frequency)	20g peak, 10-2000 Hz, 12 times in each of three perpendicular directions (total 36)	MIL-STD-202, Method 204, Condition D