

Surface Mount

# Monolithic Amplifier

DC-2 GHz

## Product Features

- Wideband, DC to 2 GHz
- Cascadable ceramic package
- Internally Matched to 50 Ohms
- Low noise figure, 6.0 dB typ.
- Excellent repeatability
- Aqueous washable
- Protected under US Patent 6,943,629

## Typical Applications

- Cellular
- UHF/VHF
- Communication system
- Transmission receivers



Generic photo used for illustration purposes only

## RAM-3+

CASE STYLE: AF190

**+RoHS Compliant**

The +Suffix identifies RoHS Compliance. See our web site for RoHS Compliance methodologies and qualifications

## General Description

RAM-3+ (RoHS compliant) is a wideband amplifier offering high dynamic range. It has repeatable performance from lot to lot. It is enclosed in a ceramic surface-mount package. RAM-3+ uses Darlington configuration and is fabricated using InGaP HBT technology. Expected MTBF is 900 years at 100°C case temperature.

## simplified schematic and pin description

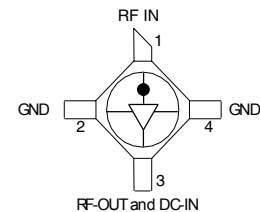

Function	Pin Number	Description
RF IN	1	RF input pin. This pin requires the use of an external DC blocking capacitor chosen for the frequency of operation.
RF-OUT and DC-IN	3	RF output and bias pin. DC voltage is present on this pin; therefore a DC blocking capacitor is necessary for proper operation. An RF choke is needed to feed DC bias without loss of RF signal due to the bias connection, as shown in "Recommended Application Circuit".
GND	2,4	Connections to ground. Use via holes as shown in "Suggested Layout for PCB Design" to reduce ground path inductance for best performance.

### Notes

- Performance and quality attributes and conditions not expressly stated in this specification document are intended to be excluded and do not form a part of this specification document.
- Electrical specifications and performance data contained in this specification document are based on Mini-Circuit's applicable established test performance criteria and measurement instructions.
- The parts covered by this specification document are subject to Mini-Circuit's standard limited warranty and terms and conditions (collectively, "Standard Terms"); Purchasers of this part are entitled to the rights and benefits contained therein. For a full statement of the Standard Terms and the exclusive rights and remedies thereunder, please visit Mini-Circuit's website at [www.minicircuits.com/MCLStore/terms.jsp](http://www.minicircuits.com/MCLStore/terms.jsp)



[www.minicircuits.com](http://www.minicircuits.com) P.O. Box 350166, Brooklyn, NY 11235-0003 (718) 934-4500 [sales@minicircuits.com](mailto:sales@minicircuits.com)

REV. D  
ECO-003934  
RAM-3+  
200902  
Page 1 of 4

Electrical Specifications at 25°C and 35mA, unless noted

Parameter	Min.	Typ.	Max.	Units
Frequency Range*	DC		2	GHz
Gain	f=0.1 GHz	—	12.5	dB
	f=1 GHz	—	12	
	f=2 GHz	8.0 <sup>2</sup>	10.5	
Input Return Loss	f=DC to 2 GHz		12.5	dB
Output Return Loss	f=DC to 2 GHz		11.5	dB
Output Power @ 1 dB compression	f=1 GHz		+10	dBm
Output IP3	f=1 GHz		+23	dBm
Noise Figure	f=1 GHz		6.0	dB
Recommended Device Operating Current			35	mA
Device Operating Voltage			5.0	V
Device Voltage Variation vs. Temperature at 35 mA			-2.6	mV/°C
Device Voltage Variation vs. Current at 25°C			15.5	mV/mA
Thermal Resistance, junction-to-case <sup>1</sup>			150	°C/W

\*Guaranteed specification DC-2 GHz. Low frequency cut off determined by external coupling capacitors.

Absolute Maximum Ratings

Parameter	Ratings
Operating Temperature	-54°C to 100°C
Storage Temperature	-65°C to 150°C
Operating Current	80mA
Power Dissipation	425mW
Input Power	13dBm

Note: Permanent damage may occur if any of these limits are exceeded. These ratings are not intended for continuous normal operation.  
<sup>1</sup>Case is defined as ground leads.  
<sup>2</sup>Full temperature range.

Notes

- A. Performance and quality attributes and conditions not expressly stated in this specification document are intended to be excluded and do not form a part of this specification document.
- B. Electrical specifications and performance data contained in this specification document are based on Mini-Circuit's applicable established test performance criteria and measurement instructions.
- C. The parts covered by this specification document are subject to Mini-Circuits standard limited warranty and terms and conditions (collectively, "Standard Terms"); Purchasers of this part are entitled to the rights and benefits contained therein. For a full statement of the Standard Terms and the exclusive rights and remedies thereunder, please visit Mini-Circuits' website at [www.minicircuits.com/MCLStore/terms.jsp](http://www.minicircuits.com/MCLStore/terms.jsp)



Product Marking

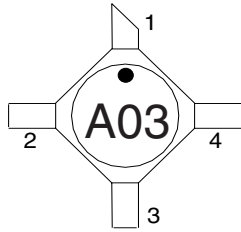

Markings in addition to model number designation may appear for internal quality control purposes.

Additional Detailed Technical Information

Additional information is available on our web site. To access this information enter the model number on our web site home page.

Performance data, graphs, s-parameter data set (.zip file)

Case Style: AF190

Ceramic surface-mount, .083 body diameter

Tape & Reel: F14

7" inch reels with 20, 50, 100, 200, 500, 1000 devices.

Suggested Layout for PCB Design: PL-254

Evaluation Board: TB-414-3+

Environmental Ratings: ENV08T6

Recommended Application Circuit

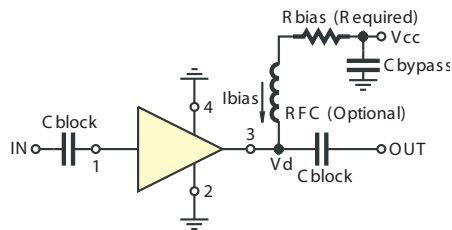

Test Board includes case, connectors, and components (in bold) soldered to PCB

R BIAS	
Vcc	"1%" Res. Values (ohms) for Optimum Biasing
7	57.6
8	86.6
9	115
10	143
11	169
12	200
13	226
14	255
15	287

Notes

- A. Performance and quality attributes and conditions not expressly stated in this specification document are intended to be excluded and do not form a part of this specification document.
- B. Electrical specifications and performance data contained in this specification document are based on Mini-Circuit's applicable established test performance criteria and measurement instructions.
- C. The parts covered by this specification document are subject to Mini-Circuits standard limited warranty and terms and conditions (collectively, "Standard Terms"); Purchasers of this part are entitled to the rights and benefits contained therein. For a full statement of the Standard Terms and the exclusive rights and remedies thereunder, please visit Mini-Circuits' website at [www.minicircuits.com/MCLStore/terms.jsp](http://www.minicircuits.com/MCLStore/terms.jsp)



**ESD Rating**

Human Body Model (HBM): Class 1B (500 v to < 1000 v) in accordance with ANSI/ESD STM 5.1 - 2001

Machine Model (MM): Class M1 (<100 v) in accordance with ANSI/ESD STM 5.2 - 1999

**Notes**

- A. Performance and quality attributes and conditions not expressly stated in this specification document are intended to be excluded and do not form a part of this specification document.
- B. Electrical specifications and performance data contained in this specification document are based on Mini-Circuit's applicable established test performance criteria and measurement instructions.
- C. The parts covered by this specification document are subject to Mini-Circuits standard limited warranty and terms and conditions (collectively, "Standard Terms"); Purchasers of this part are entitled to the rights and benefits contained therein. For a full statement of the Standard Terms and the exclusive rights and remedies thereunder, please visit Mini-Circuits' website at [www.minicircuits.com/MCLStore/terms.jsp](http://www.minicircuits.com/MCLStore/terms.jsp)



# MMIC Amplifier

# RAM-3+

## Typical Performance Data

FREQUENCY (MHz)	GAIN (dB) 35 mA	ISOLATION (dB) 35 mA	RETURN LOSS IN (dB) 35 mA	RETURN LOSS OUT (dB) 35 mA
100	13.00	18.42	23.10	16.48
500	12.80	18.42	24.44	15.92
1000	12.50	17.72	26.02	14.98
1500	11.80	17.08	27.96	13.56
2000	10.50	14.98	24.44	12.04
2500	10.30	14.42	15.39	11.70
3000	9.10	13.98	12.40	12.04
3500	7.80	13.56	9.90	12.04
4000	6.50	13.15	8.18	12.04

REV. X1  
RAM-3+  
061101  
Page 1 of 1



IF/RF MICROWAVE COMPONENTS • ISO 9001 ISO 14001 AS 9100 CERTIFIED RoHS compliant  
P.O. Box 350166, Brooklyn, New York 11235-0003 (718) 934-4500 Fax (718) 332-4661



The Design Engineers Search Engine finds the model you need, Instantly • For detailed performance specs & shopping online see



## Typical Performance Curves

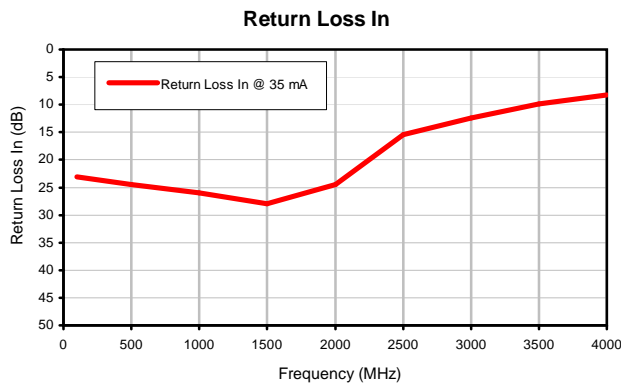
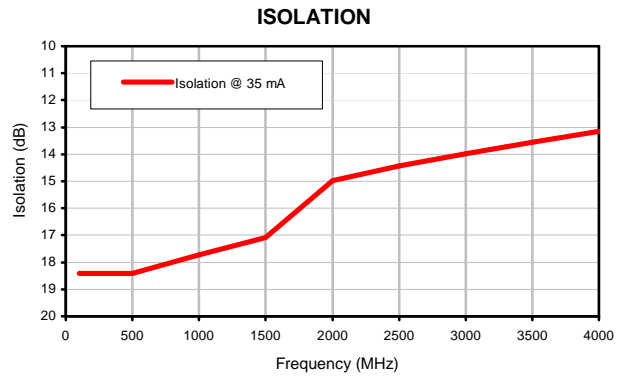
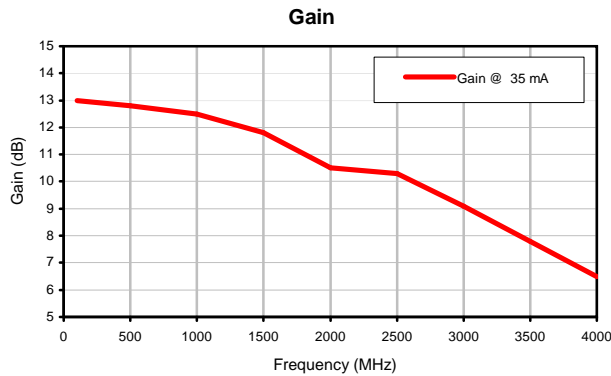

### Outline Dimensions

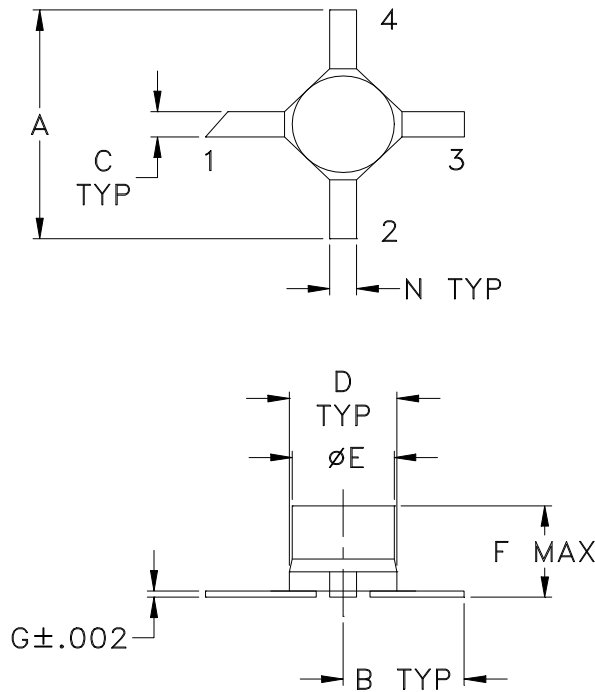

### PCB Land Pattern

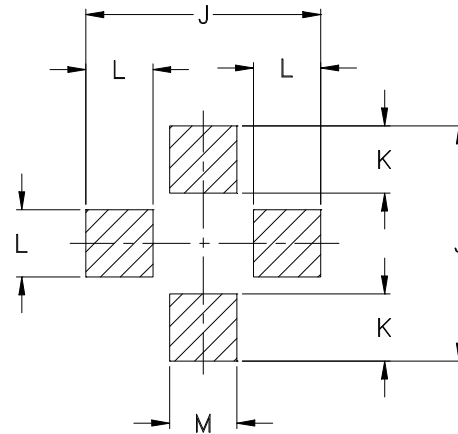

Suggested Layout,  
Tolerance to be within  $\pm .002$

CASE #	A	B	C	D	E	F	G	H	J	K	L	M	N	WT. GRAM
AF190	.180 (4.57)	.090 (2.29)	.020 (0.51)	.100 (2.54)	.083 (2.11)	.072 (1.83)	.005 (0.13)	-	.210 (5.33)	.060 (1.52)	.060 (1.52)	.060 (1.52)	.020 (0.51)	.04

Dimensions are in inches (mm). Tolerances: 2Pl.  $\pm .03$ ; 3Pl.  $\pm .015$

#### Notes:

- Case material: Ceramic.
- Termination material:  
Nickel-Iron alloy 42.
- Termination finish:  
For RoHS Case Styles: Tin-Silver alloy plate over Nickel barrier.  
For RoHS-5 Case Styles: Tin-Lead plate.
- Termination (1):  
Identified by diagonally cut lead.
- Special Tolerances: Termination width  $\pm .005$  inch, termination thickness  $\pm .002$  inch, cap diameter  $\pm .005$  inch.



INTERNET <http://www.minicircuits.com>

P.O. Box 350166, Brooklyn, New York 11235-0003 (718) 934-4500 Fax (718) 332-4661

Distribution Centers NORTH AMERICA 800-654-7949 • 417-335-5935 • Fax 417-335-5945 • EUROPE 44-1252-832600 • Fax 44-1252-837010

Mini-Circuits ISO 9001 & ISO 14001 Certified

THIRD ANGLE PROJECTION

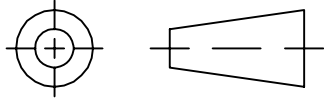

REVISIONS

REV	ECN No.	DESCRIPTION	DATE	DR	AUTH
OR	M108436	NEW RELEASE	11/14/06	PW	IG
A	M108585	UPDATED DRAWING PER TB-414+	11/24/06	PW	MM

SUGGESTED MOUNTING CONFIGURATION FOR AF190 CASE STYLE, "cb" PIN CONNECTION

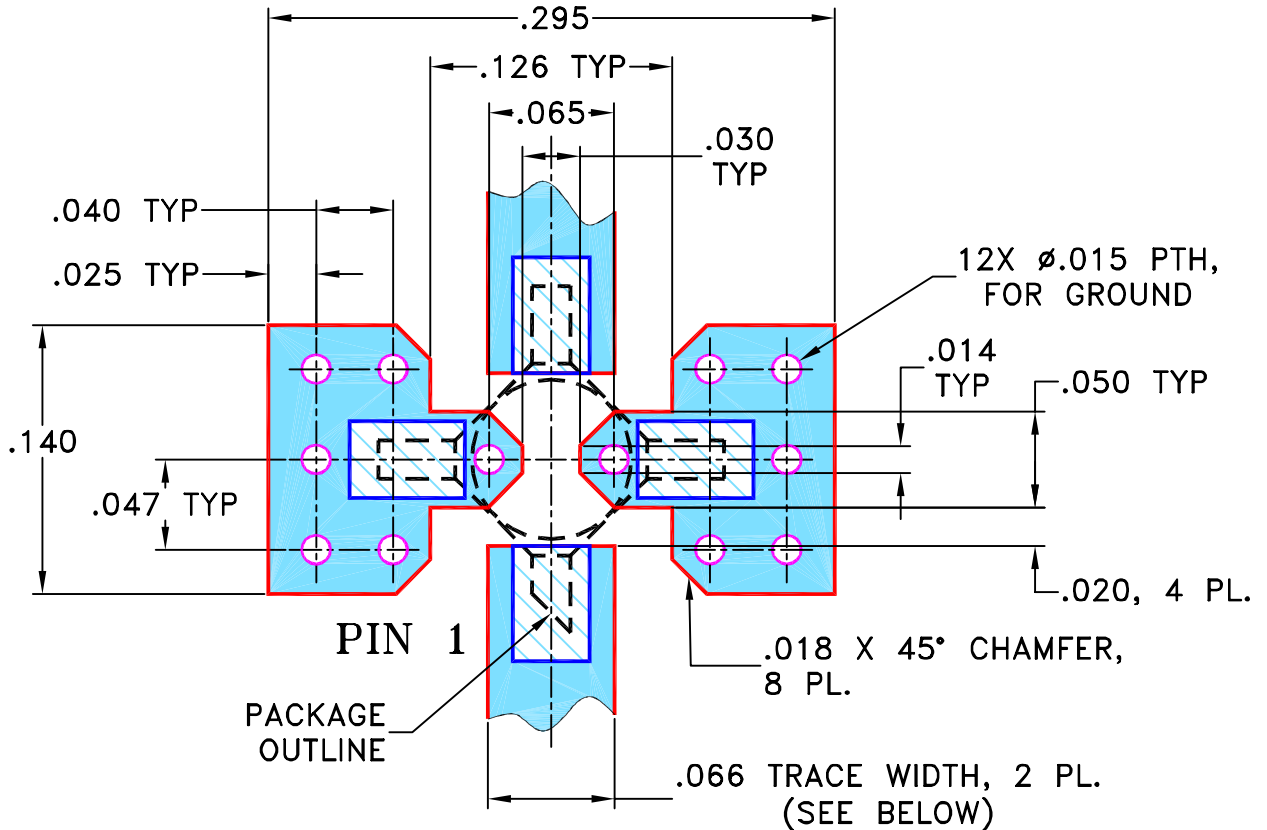

NOTES:

1. TRACE WIDTH IS SHOWN FOR ROGERS R04350B WITH DIELECTRIC THICKNESS .030" ± .002"; COPPER: 1/2 OZ. EACH SIDE. FOR OTHER MATERIALS TRACE WIDTH MAY NEED TO BE MODIFIED.
2. BOTTOM SIDE OF THE PCB IS CONTINUOUS GROUND PLANE.
3. IF PCB DESIGN RULES ALLOW, PLACE GROUND VIAS UNDER THE LAND PATTERN FOR BETTER RF PERFORMANCE. OTHERWISE PLACE GROUND VIAS AS CLOSE TO LAND PATTERN AS POSSIBLE.

- DENOTES PCB COPPER LAYOUT WITH SMOBC (SOLDER MASK OVER BARE COPPER)
- DENOTES COPPER LAND PATTERN FREE OF SOLDER MASK

UNLESS OTHERWISE SPECIFIED	INITIALS	DATE
DIMENSIONS ARE IN INCHES TOLERANCES ON: 2 PL DECIMALS ± 3 PL DECIMALS ± .005 ANGLES ± FRACTIONS ±	DRAWN	PW 11/11/06
	CHECKED	IL 11/14/06
	APPROVED	IG 11/14/06

**Mini-Circuits®** 13 Neptune Avenue  
Brooklyn NY 11235

PL, cb, AF190, RAM, TB-414-X+

Mini-Circuits®  
 THIS DOCUMENT AND ITS CONTENTS ARE THE PROPERTY OF MINI-CIRCUITS. EXCEPT FOR USE EXPRESSLY GRANTED, IN WRITING, TO ITS VENDORS, VENDEE AND THE UNITED STATES GOVERNMENT, MINI-CIRCUITS RESERVES ALL PROPRIETARY DESIGN, USE, MANUFACTURING AND REPRODUCTION RIGHTS THERETO. THESE CONTENTS SHALL NOT BE USED, DUPLICATED OR DISCLOSED TO ANY OUTSIDE PARTY, IN WHOLE OR IN PART, WITHOUT WRITTEN PERMISSION OF MINI-CIRCUITS.

SIZE A	CODE IDENT 15542	DRAWING NO: 98-PL-254	REV: A
FILE: 98PL254	SCALE: 10:1	SHEET: 1 OF 1	



# Evaluation Board and Circuit

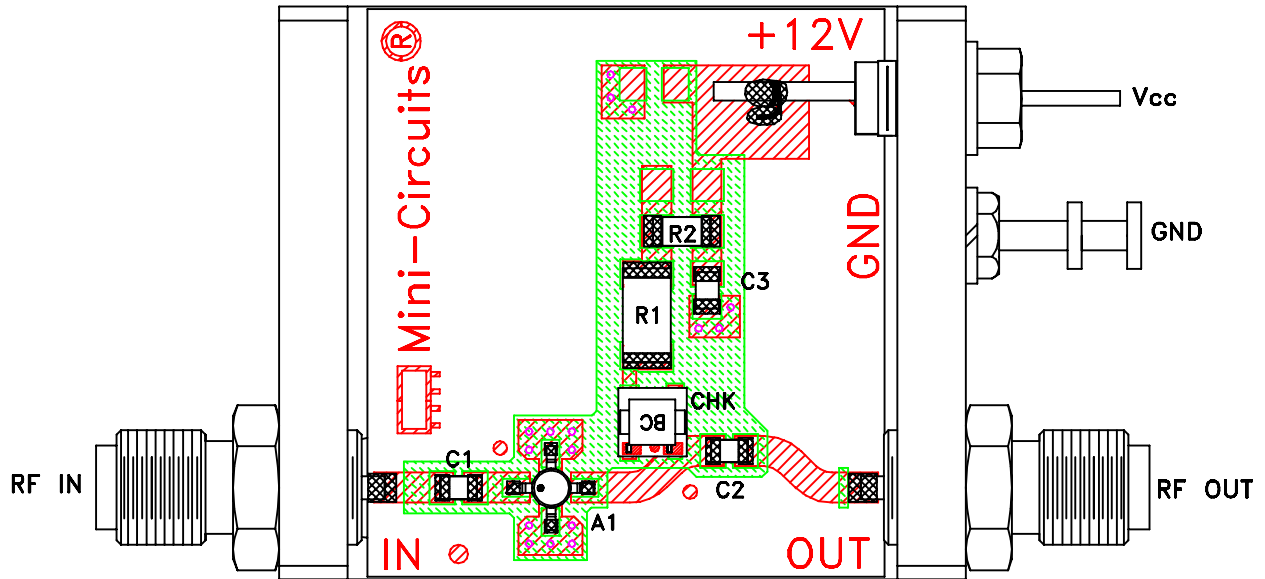

TB-414-3+

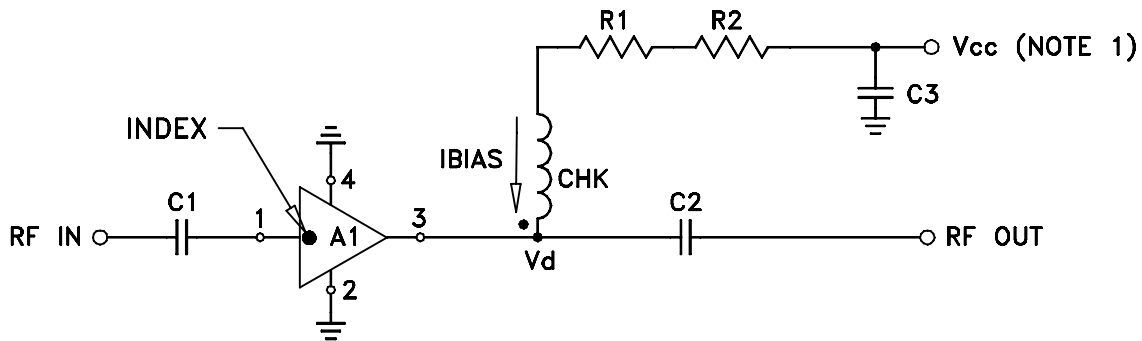

COMPONENT	VALUE
A1	RAM-3(+)
C1 (NOTE 4)	2400 pF
C2 (NOTE 4)	2400 pF
C3 (bypass)	0.1 uF
R1	200 Ohms, 0.75W
R2	0 Ohm, 0.25W
CHK	Mini-Circuits TCCH-80+

Schematic Diagram

**NOTE:**

1. Vcc voltage:  $+12 \pm 0.2V$ .
2. SMA Female connectors.
3. PCB material: Rogers R04350 or equivalent, dielectric constant=3.5, dielectric thickness=.030 inch.
4. Capacitors, C1 & C2 should be free of resonance up to the highest frequency specified.

 **Mini-Circuits®**

All Mini-Circuits products are manufactured under exacting quality assurance and control standards, and are capable of meeting published specifications after being subjected to any or all of the following physical and environmental test.

Specification	Test/Inspection Condition	Reference/Spec
Operating Temperature	-54° to 100°C Ambient Environment	Individual Model Data Sheet
Storage Temperature	-65° to 150° C Ambient Environment	Individual Model Data Sheet
HTOL	1000 hours at 125°C	MIL-STD-883, Method 1005, Condition B
Thermal Shock	-55° to 105°C, 100 cycles	MIL-STD-202, Method 107, Condition A-3, except +100°C
Mechanical Shock	1500g, 0.5 ms, 5 shock pulses, Y1 direction only	MIL-STD-883, Method 2002, Condition B, except Y1 direction only.
Vibration (Variable Frequency)	50g peak 20-2000 Hz, 4 times in each of three perpendicular directions (total 12)	MIL-STD-883, Method 2007, Condition B
Autoclave	15 psig, 100% RH, 121°C, 96 hours	JEDEC-STD-22-B, Method A102
Solderability	10X Magnification	J-STD-002, Para 4.2.5, Test S, 95% Coverage
Solder Reflow Heat	Sn-Pb Eutetic Process: 240°C peak Pb-Free Process: 260°C peak	J-STD-020, Table 4-1, 4-2 and 5-2; Figure 5-1
Moisture Sensitivity: Level 1	Bake at 125°C for 24 hours. Soak at 85°C/85%RH for 168 hours Reflow 3 cycles at 260°C peak	J-STD-020
Marking Resistance to Solvents	Isopropyl alcohol + mineral spirits at 25°C; terpene defluxer at 25°C;	MIL-STD-202, Method 215

All Mini-Circuits products are manufactured under exacting quality assurance and control standards, and are capable of meeting published specifications after being subjected to any or all of the following physical and environmental test.

**Specification****Test/Inspection Condition****Reference/Spec**

distilled water + proylene glycol monomethyl ether +  
monoethanolamine at 63°C to 70°C