



ULTRA-SMALL CERAMIC

Power Splitter/Combiner

QCN-27+

2 Way-90° 50Ω 1700 to 2700 MHz

FEATURES

- Low insertion loss, 0.4 dB typ.
- High isolation, 26 dB typ.
- Wrap-around terminal for excellent solderability
- Ultra small, 0.12"x0.06"x0.035"
- Patent pending

APPLICATIONS

- Balanced amplifiers
- Modulators
- PCS/DCS
- MMDS
- ISM

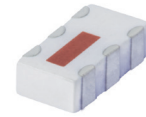

Generic photo used for illustration purposes only

CASE STYLE: FV1206-1

+RoHS Compliant

The +Suffix identifies RoHS Compliance. See our website for methodologies and qualifications

ELECTRICAL SPECIFICATIONS AT 25°C

Parameter	Frequency (MHz)	Min.	Typ.	Max.	Unit
Frequency Range		1700		2700	MHz
Insertion Loss, above 3.0 dB	1700-1800		0.4	0.7	dB
	1800-2000		0.4	0.7	
	2000-2400		0.4	0.7	
	2400-2700		0.5	0.9	
Isolation	1700-1800	18	21		dB
	1800-2000	18	22		
	2000-2400	20	30		
	2400-2700	20	30		
Phase Unbalance	1700-1800		3	6	Degree
	1800-2000		2	6	
	2000-2400		3	6	
	2400-2700		3	6	
Amplitude Unbalance	1700-1800		0.5	1.0	dB
	1800-2000		0.3	0.8	
	2000-2400		0.2	0.8	
	2400-2700		0.6	1.0	
VSWR	1700-1800		1.2		(:1)
	1800-2000		1.2		
	2000-2400		1.2		
	2400-2700		1.2		

1. For applications requiring DC voltage to be applied to the RF ports, add suffix letter "D" to part no. DC resistance to ground is 100 Mohms min.

MAXIMUM RATINGS

Parameter	Ratings
Operating Temperature	-55°C to 100°C
Storage Temperature	-55°C to 100°C
Power Input (as a splitter)	15W* max.

* Derate linearly to 7W at 100°C ambient. Permanent damage may occur if any of these limits are exceeded.

ELECTRICAL SCHEMATIC (NOTE 1)

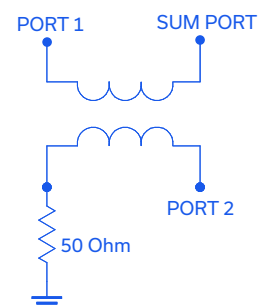



PIN CONNECTIONS

SUM PORT	1
PORT 1 (0°)	4
PORT 2 (+90°)	6
GROUND	2,5
50 OHM TERM EXTERNAL	3

PRODUCT MARKING: N/A

DEMO BOARD MCL P/N: TB-255
SUGGESTED PCB LAYOUT (PL-131)

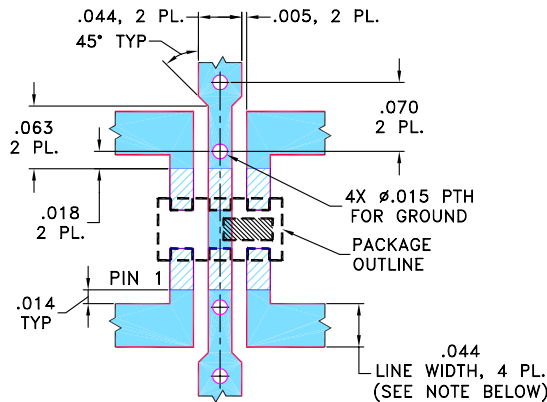

NOTES: 1. TRACE WIDTH IS SHOWN FOR ROGERS RO4350B WITH DIELECTRIC THICKNESS 0.020" ± 0.0015"; COPPER: 1/2 OZ. EACH SIDE. FOR OTHER MATERIALS TRACE WIDTH MAY NEED TO BE MODIFIED.

2. BOTTOM SIDE OF THE PCB IS CONTINUOUS GROUND PLANE.

- DENOTES PCB COPPER LAYOUT WITH SMOBC (SOLDER MASK OVER BARE COPPER)
- DENOTES COPPER LAND PATTERN FREE OF SOLDER MASK

OUTLINE DRAWING

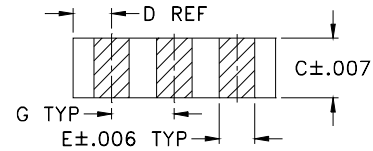
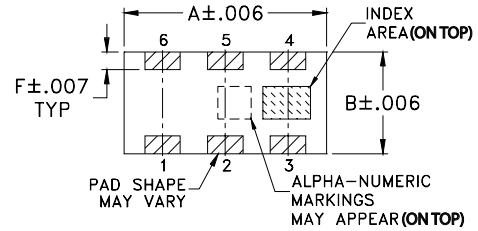

PCB Land Pattern

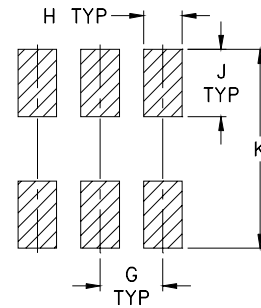

Suggested Layout,
Tolerance to be within ±.002

OUTLINE DIMENSIONS (Inches/mm)

A	B	C	D	E	F
.126	.063	.035	.024	.022	.011
3.20	1.60	0.89	0.61	0.56	0.28
G	H	J	K	wt	
.039	.024	.042	.123	grams	
0.99	0.61	1.07	3.12	.020	

TAPE & REEL INFORMATION: F75



ULTRA-SMALL CERAMIC

Power Splitter/Combiner

QCN-27+

2 Way-90° 50Ω 1700 to 2700 MHz

TYPICAL PERFORMANCE DATA

Frequency (MHz)	Total Loss ¹ (dB)		Amplitude Unbalance (dB)	Isolation (dB)	Phase Unbalance (deg.)	VSWR (:1)		
	S-1	S-2				S	1	2
1700.00	3.12	3.68	0.56	21.52	88.45	1.23	1.26	1.19
1800.00	3.24	3.55	0.31	22.55	88.66	1.21	1.24	1.17
1900.00	3.33	3.44	0.12	23.84	88.92	1.18	1.23	1.14
2000.00	3.40	3.37	0.03	25.33	88.93	1.16	1.21	1.12
2100.00	3.45	3.33	0.12	26.85	88.95	1.14	1.20	1.10
2200.00	3.48	3.32	0.16	28.90	89.07	1.12	1.19	1.09
2300.00	3.48	3.33	0.15	31.22	89.25	1.10	1.18	1.09
2400.00	3.45	3.37	0.08	34.26	89.24	1.08	1.17	1.10
2500.00	3.40	3.44	0.04	38.56	89.27	1.06	1.17	1.11
2600.00	3.33	3.54	0.22	45.07	89.20	1.04	1.16	1.12
2650.00	3.28	3.61	0.33	52.09	89.34	1.03	1.16	1.13
2700.00	3.23	3.68	0.45	57.17	89.32	1.01	1.16	1.14

1. Total Loss = Insertion Loss + 3 dB splitter loss.

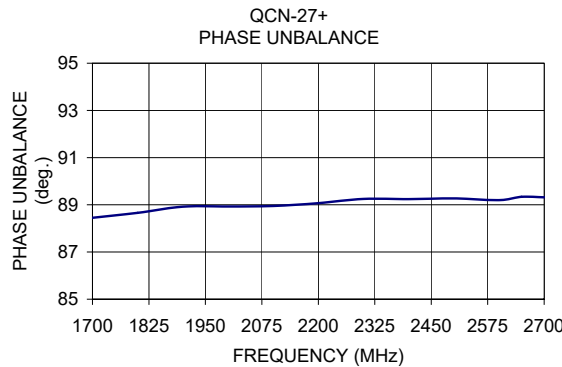
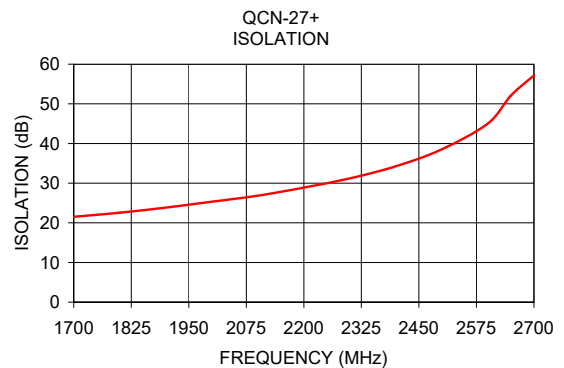
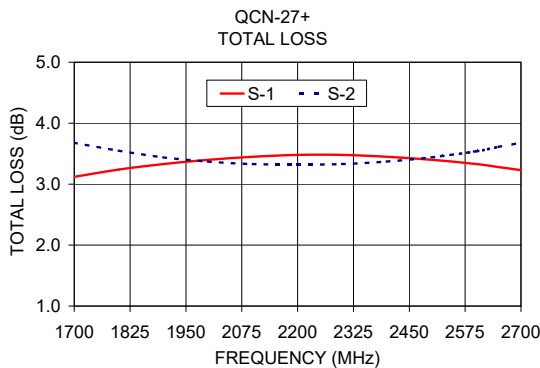

- NOTES**
- A. Performance and quality attributes and conditions not expressly stated in this specification document are intended to be excluded and do not form a part of this specification document.
 - B. Electrical specifications and performance data contained in this specification document are based on Mini-Circuit's applicable established test performance criteria and measurement instructions.
 - C. The parts covered by this specification document are subject to Mini-Circuits standard limited warranty and terms and conditions (collectively, "Standard Terms"); Purchasers of this part are entitled to the rights and benefits contained therein. For a full statement of the standard. Terms and the exclusive rights and remedies thereunder, please visit Mini-Circuits' website at www.minicircuits.com/terms/viewterm.html



2 Way-90° Power Splitter/Combiner

QCN-27+

Typical Performance Data

TEST CONDITIONS: INPUT POWER = 0dBm @Temperature = +25°C

FREQ. (MHz)	TOTAL LOSS ¹ (dB)		AMP. UNBAL. (dB)	PHASE UNBAL. From 90° (deg.)	ISOLATION (dB) 1-2	VSWR (:1)		
	S-1	S-2				S	1	2
900	1.61	6.19	4.58	3.15	18.98	1.27	1.26	1.27
950	1.72	5.91	4.19	3.15	18.95	1.27	1.27	1.27
1000	1.82	5.66	3.83	3.12	19.00	1.27	1.27	1.27
1100	2.03	5.21	3.18	3.04	19.16	1.27	1.26	1.26
1150	2.13	5.01	2.88	2.97	19.31	1.26	1.26	1.26
1200	2.23	4.82	2.60	2.90	19.48	1.26	1.26	1.25
1250	2.32	4.66	2.34	2.82	19.67	1.25	1.25	1.24
1300	2.41	4.50	2.09	2.74	19.92	1.24	1.25	1.24
1350	2.50	4.36	1.86	2.68	20.15	1.23	1.24	1.23
1400	2.58	4.23	1.65	2.60	20.45	1.23	1.23	1.22
1450	2.66	4.11	1.44	2.53	20.76	1.22	1.22	1.21
1500	2.74	4.00	1.26	2.46	21.04	1.21	1.22	1.20
1600	2.89	3.80	0.91	2.31	21.79	1.19	1.20	1.18
1650	2.95	3.71	0.76	2.30	22.22	1.18	1.19	1.17
1700	3.02	3.64	0.62	2.22	22.68	1.17	1.18	1.16
1750	3.08	3.57	0.49	2.17	23.14	1.16	1.17	1.15
1800	3.13	3.50	0.37	2.14	23.66	1.16	1.16	1.13
1850	3.18	3.45	0.27	2.09	24.23	1.15	1.15	1.12
1900	3.22	3.40	0.17	2.05	24.83	1.14	1.14	1.11
1950	3.26	3.36	0.09	2.01	25.54	1.13	1.13	1.11
2000	3.30	3.32	0.03	1.99	26.30	1.12	1.12	1.10
2050	3.33	3.29	0.03	1.96	27.01	1.11	1.11	1.09
2100	3.36	3.27	0.08	1.95	28.02	1.10	1.10	1.08
2150	3.38	3.26	0.12	1.94	28.99	1.09	1.10	1.07
2200	3.39	3.25	0.15	1.92	30.19	1.08	1.09	1.07
2300	3.41	3.25	0.16	1.88	33.06	1.07	1.07	1.06
2350	3.41	3.26	0.15	1.86	34.91	1.06	1.06	1.06
2400	3.40	3.27	0.13	1.84	37.08	1.05	1.06	1.06
2450	3.39	3.29	0.09	1.84	39.58	1.05	1.05	1.07
2500	3.37	3.32	0.05	1.83	41.74	1.04	1.04	1.07
2550	3.35	3.36	0.01	1.81	41.44	1.04	1.03	1.08
2600	3.32	3.40	0.09	1.81	39.51	1.04	1.03	1.08
2650	3.28	3.46	0.17	1.74	36.98	1.04	1.03	1.09
2700	3.24	3.52	0.27	1.69	35.03	1.04	1.03	1.10
2750	3.20	3.58	0.38	1.65	33.34	1.04	1.03	1.11
2800	3.15	3.66	0.51	1.60	31.80	1.05	1.04	1.12
2850	3.09	3.74	0.65	1.56	30.83	1.06	1.05	1.13
2900	3.03	3.84	0.81	1.46	29.72	1.07	1.06	1.14
3000	2.89	4.06	1.17	1.26	28.19	1.10	1.08	1.17
3050	2.82	4.19	1.37	1.11	27.45	1.11	1.09	1.17
3100	2.74	4.34	1.59	0.99	26.70	1.12	1.10	1.19
3150	2.66	4.50	1.84	0.83	26.11	1.14	1.12	1.20
3200	2.58	4.67	2.09	0.66	25.49	1.15	1.13	1.22
3250	2.49	4.86	2.37	0.45	24.93	1.17	1.15	1.23
3300	2.40	5.07	2.67	0.20	24.43	1.18	1.16	1.24
3350	2.31	5.30	2.99	0.06	23.93	1.20	1.18	1.26
3400	2.22	5.56	3.34	0.34	23.53	1.22	1.19	1.27
3450	2.12	5.84	3.71	0.67	23.11	1.23	1.21	1.29
3500	2.03	6.15	4.11	1.01	22.70	1.25	1.23	1.30
3550	1.94	6.49	4.55	1.42	22.38	1.27	1.25	1.32
3600	1.85	6.86	5.01	1.91	22.03	1.29	1.27	1.33
3700	1.67	7.73	6.06	3.09	21.45	1.32	1.30	1.37
3750	1.59	8.23	6.65	3.79	21.19	1.34	1.32	1.38
3800	1.50	8.80	7.29	4.59	20.90	1.36	1.34	1.39

¹ Total Loss = Insertion Loss+ 3dB Splitter Loss

REV. X2
QCN-27+
100627

Page 1 of 3



IR/RF MICROWAVE COMPONENTS • ISO 9001 ISO 14001 AS 9100 CERTIFIED • RoHS compliant
P.O. Box 350166, Brooklyn, New York 11235-0006 (718) 934-4500 Fax (718) 332-4661



The Design Engineers Search Engine finds the model you need, Instantly • For detailed performance specs & shopping online see



2 Way-90° Power Splitter/Combiner

QCN-27+

Typical Performance Data

TEST CONDITIONS: INPUT POWER = 0dBm @Temperature = -55°C

FREQ. (MHz)	TOTAL LOSS ¹ (dB)		AMP. UNBAL. (dB)	PHASE UNBAL. From 90° (deg.)	ISOLATION (dB)	VSWR (:1)		
	S-1	S-2				S	1	2
900	1.46	6.06	4.60	3.38	18.71	1.27	1.27	1.28
950	1.57	5.78	4.21	3.42	18.65	1.28	1.28	1.28
1000	1.67	5.53	3.85	3.47	18.57	1.28	1.28	1.29
1100	1.87	5.07	3.20	3.54	18.69	1.28	1.29	1.29
1150	1.97	4.88	2.91	3.48	18.72	1.28	1.29	1.29
1200	2.06	4.69	2.63	3.50	18.72	1.29	1.29	1.29
1250	2.15	4.53	2.38	3.48	18.80	1.28	1.29	1.29
1300	2.23	4.38	2.14	3.36	19.01	1.28	1.28	1.28
1350	2.31	4.23	1.92	3.31	19.32	1.27	1.28	1.28
1400	2.39	4.10	1.71	3.19	19.52	1.26	1.26	1.27
1450	2.46	3.97	1.51	3.11	19.77	1.25	1.26	1.26
1500	2.53	3.86	1.33	3.02	20.04	1.24	1.25	1.25
1600	2.66	3.65	0.99	2.79	20.78	1.21	1.23	1.22
1650	2.72	3.55	0.83	2.74	21.27	1.20	1.21	1.20
1700	2.78	3.46	0.68	2.66	21.70	1.19	1.21	1.19
1750	2.83	3.38	0.55	2.56	22.20	1.18	1.19	1.16
1800	2.88	3.31	0.42	2.52	22.74	1.17	1.17	1.14
1850	2.93	3.24	0.31	2.45	23.47	1.15	1.15	1.12
1900	2.97	3.18	0.21	2.43	24.13	1.14	1.13	1.10
1950	3.01	3.12	0.11	2.43	24.89	1.13	1.12	1.08
2000	3.05	3.08	0.04	2.47	26.02	1.12	1.11	1.06
2050	3.08	3.04	0.04	2.48	26.72	1.12	1.10	1.04
2100	3.10	3.01	0.09	2.53	27.76	1.11	1.08	1.02
2150	3.12	2.99	0.14	2.62	29.30	1.10	1.07	1.02
2200	3.14	2.97	0.17	2.69	30.60	1.10	1.06	1.04
2300	3.15	2.96	0.19	2.78	32.50	1.08	1.03	1.08
2350	3.15	2.97	0.17	2.84	32.97	1.08	1.02	1.10
2400	3.13	2.99	0.14	2.93	32.79	1.07	1.01	1.13
2450	3.11	3.01	0.10	2.91	32.10	1.06	1.02	1.15
2500	3.09	3.04	0.05	2.91	30.91	1.05	1.04	1.17
2550	3.07	3.08	0.01	2.91	29.31	1.05	1.05	1.19
2600	3.03	3.13	0.10	2.90	27.79	1.04	1.06	1.21
2650	2.99	3.19	0.19	2.77	27.00	1.04	1.08	1.24
2700	2.96	3.24	0.28	2.64	26.31	1.04	1.09	1.26
2750	2.92	3.32	0.40	2.53	25.24	1.07	1.11	1.28
2800	2.87	3.39	0.52	2.34	24.49	1.08	1.13	1.31
2850	2.82	3.47	0.64	2.20	23.99	1.10	1.14	1.33
2900	2.78	3.55	0.77	2.00	23.63	1.11	1.16	1.34
3000	2.66	3.73	1.07	1.77	23.10	1.14	1.18	1.35
3050	2.60	3.83	1.23	1.63	23.03	1.14	1.18	1.36
3100	2.53	3.94	1.41	1.55	22.86	1.14	1.19	1.35
3150	2.46	4.06	1.61	1.53	22.83	1.14	1.19	1.35
3200	2.36	4.20	1.84	1.63	23.20	1.13	1.17	1.34
3250	2.27	4.37	2.10	1.62	23.15	1.14	1.17	1.34
3300	2.18	4.54	2.36	1.63	23.27	1.12	1.17	1.33
3350	2.07	4.72	2.65	1.65	23.82	1.10	1.17	1.29
3400	1.95	4.94	2.99	1.67	24.30	1.09	1.16	1.27
3450	1.83	5.19	3.36	1.64	24.78	1.08	1.14	1.25
3500	1.71	5.46	3.75	1.54	25.20	1.07	1.13	1.22
3550	1.60	5.77	4.18	1.41	25.87	1.07	1.13	1.19
3600	1.47	6.12	4.65	1.23	26.32	1.09	1.13	1.16
3700	1.25	6.94	5.69	0.62	26.76	1.12	1.12	1.10
3750	1.14	7.42	6.28	0.29	26.48	1.15	1.12	1.06
3800	1.04	7.96	6.92	0.17	25.69	1.18	1.13	1.06

¹ Total Loss = Insertion Loss+ 3dB Splitter Loss

REV. X2
QCN-27+
100627

Page 2 of 3



RF/MICROWAVE COMPONENTS • ISO 9001 ISO 14001 AS 9100 CERTIFIED • RoHS compliant
P.O. Box 350166, Brooklyn, New York 11235-0006 (718) 934-4500 Fax (718) 332-4661



The Design Engineers Search Engine finds the model you need, Instantly • For detailed performance specs & shopping online see



2 Way-90° Power Splitter/Combiner

QCN-27+

Typical Performance Data

TEST CONDITIONS: INPUT POWER = 0dBm @Temperature = +100°C

FREQ. (MHz)	TOTAL LOSS ¹ (dB)		AMP. UNBAL. (dB)	PHASE UNBAL. From 90° (deg.)	ISOLATION (dB)	VSWR (:1)		
	S-1	S-2				S	1	2
900	1.67	6.23	4.56	2.83	19.52	1.27	1.26	1.26
950	1.78	5.95	4.17	2.76	19.55	1.26	1.26	1.26
1000	1.89	5.69	3.80	2.69	19.70	1.26	1.25	1.25
1100	2.10	5.23	3.13	2.57	20.02	1.24	1.24	1.22
1150	2.20	5.03	2.83	2.45	20.28	1.23	1.23	1.21
1200	2.30	4.84	2.55	2.36	20.59	1.22	1.22	1.20
1250	2.40	4.67	2.28	2.25	20.87	1.21	1.21	1.19
1300	2.49	4.52	2.02	2.18	21.18	1.20	1.20	1.17
1350	2.58	4.37	1.79	2.13	21.45	1.19	1.19	1.16
1400	2.67	4.25	1.57	2.05	21.84	1.18	1.18	1.15
1450	2.76	4.13	1.36	2.01	22.24	1.17	1.17	1.14
1500	2.84	4.02	1.17	1.96	22.56	1.16	1.16	1.13
1600	3.01	3.83	0.82	1.85	23.46	1.15	1.15	1.12
1650	3.08	3.75	0.67	1.82	23.93	1.14	1.14	1.12
1700	3.15	3.68	0.53	1.79	24.32	1.13	1.13	1.12
1750	3.22	3.62	0.40	1.74	24.62	1.13	1.13	1.13
1800	3.28	3.57	0.29	1.74	24.98	1.13	1.13	1.13
1850	3.33	3.52	0.19	1.73	25.37	1.12	1.13	1.14
1900	3.38	3.49	0.11	1.71	25.66	1.12	1.13	1.15
1950	3.42	3.45	0.03	1.69	25.97	1.12	1.13	1.16
2000	3.46	3.43	0.03	1.70	26.17	1.12	1.13	1.17
2050	3.50	3.41	0.08	1.69	26.28	1.12	1.13	1.17
2100	3.53	3.40	0.12	1.67	26.52	1.12	1.13	1.18
2150	3.55	3.40	0.15	1.65	26.65	1.11	1.13	1.19
2200	3.57	3.40	0.17	1.60	26.87	1.11	1.13	1.19
2300	3.58	3.42	0.16	1.55	27.32	1.10	1.14	1.20
2350	3.58	3.44	0.14	1.49	27.60	1.10	1.13	1.20
2400	3.57	3.46	0.11	1.44	27.97	1.10	1.13	1.20
2450	3.55	3.49	0.06	1.38	28.43	1.09	1.13	1.20
2500	3.53	3.53	0.01	1.30	28.93	1.08	1.12	1.19
2550	3.51	3.57	0.06	1.22	29.31	1.08	1.12	1.18
2600	3.47	3.62	0.14	1.14	29.58	1.07	1.12	1.17
2650	3.43	3.67	0.24	1.02	30.12	1.06	1.11	1.17
2700	3.39	3.73	0.34	0.90	30.73	1.05	1.11	1.16
2750	3.35	3.80	0.46	0.80	31.15	1.05	1.11	1.14
2800	3.30	3.89	0.59	0.65	31.28	1.05	1.10	1.13
2850	3.24	3.97	0.73	0.55	31.21	1.06	1.10	1.11
2900	3.18	4.07	0.89	0.42	31.05	1.07	1.09	1.09
3000	3.04	4.29	1.25	0.22	29.99	1.09	1.07	1.05
3050	2.97	4.42	1.45	0.12	29.25	1.11	1.05	1.04
3100	2.90	4.57	1.67	0.08	28.21	1.13	1.04	1.03
3150	2.82	4.74	1.92	0.00	27.16	1.16	1.02	1.05
3200	2.75	4.94	2.19	0.04	26.10	1.19	1.01	1.09
3250	2.67	5.16	2.49	0.14	25.19	1.21	1.04	1.13
3300	2.58	5.40	2.82	0.20	24.36	1.24	1.07	1.17
3350	2.49	5.68	3.19	0.31	23.49	1.27	1.12	1.22
3400	2.41	6.00	3.59	0.53	22.81	1.31	1.17	1.28
3450	2.32	6.35	4.03	0.84	22.14	1.35	1.22	1.35
3500	2.25	6.76	4.51	1.24	21.49	1.40	1.28	1.42
3550	2.18	7.20	5.01	1.79	20.98	1.46	1.35	1.50
3600	2.11	7.70	5.59	2.58	20.51	1.51	1.41	1.59
3700	2.02	8.81	6.79	4.76	19.97	1.64	1.56	1.77
3750	1.98	9.45	7.47	6.19	19.70	1.70	1.64	1.86
3800	1.95	10.12	8.18	7.76	19.48	1.76	1.71	1.94

¹ Total Loss = Insertion Loss+ 3dB Splitter Loss

REV. X2
QCN-27+
100627

Page 3 of 3



RF/MICROWAVE COMPONENTS • ISO 9001 ISO 14001 AS 9100 CERTIFIED • RoHS compliant
P.O. Box 350166, Brooklyn, New York 11235-0006 (718) 934-4500 Fax (718) 332-4661



The Design Engineers Search Engine finds the model you need, Instantly • For detailed performance specs & shopping online see



Typical Performance Curves

Total Loss

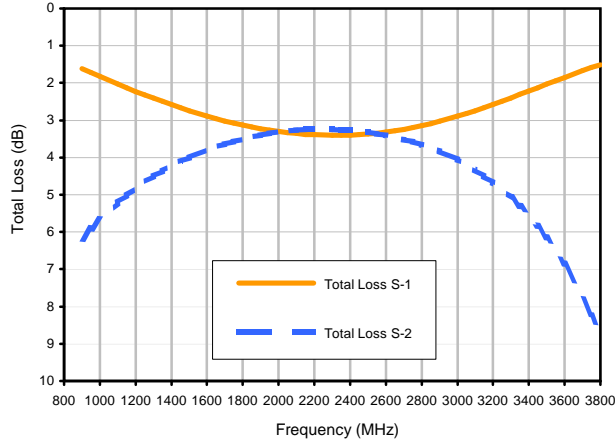

Total Loss S-1 vs. TEMPERATURE

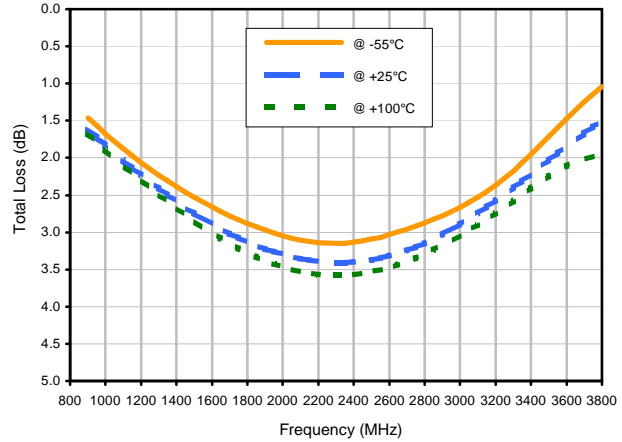

Amplitude Unbalance vs. TEMPERATURE

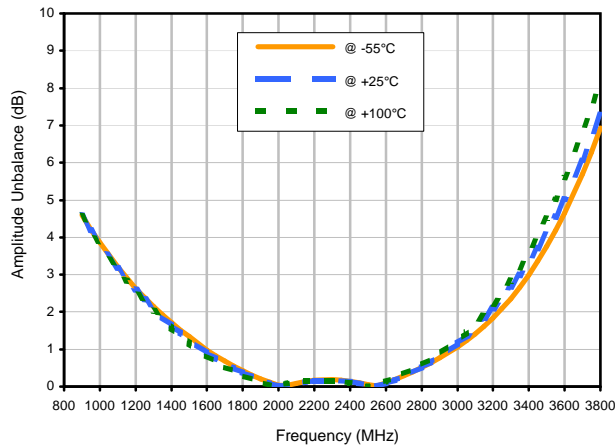

Phase Unbalance vs. TEMPERATURE

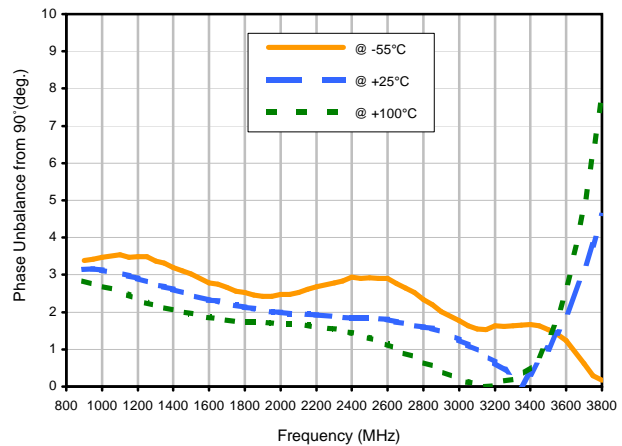

Isolation 1-2 vs. TEMPERATURE

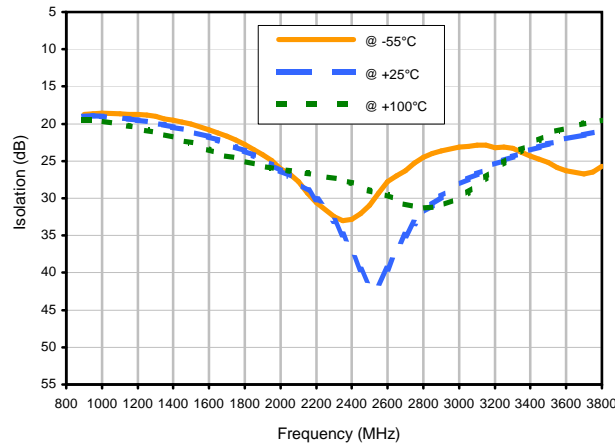

2 Way-90° Power Splitter/Combiner

QCN-27+

Typical Performance Curves

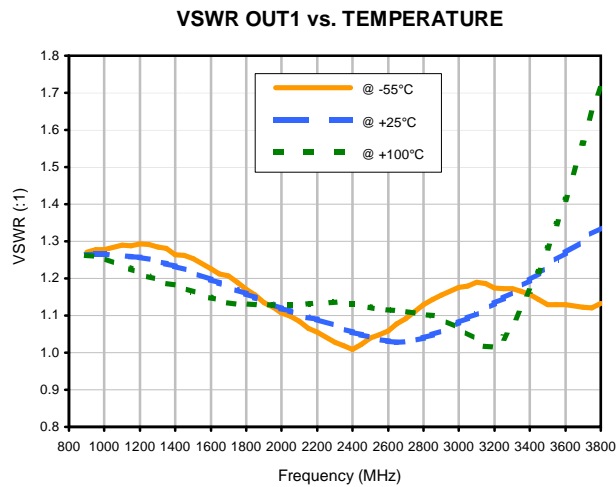
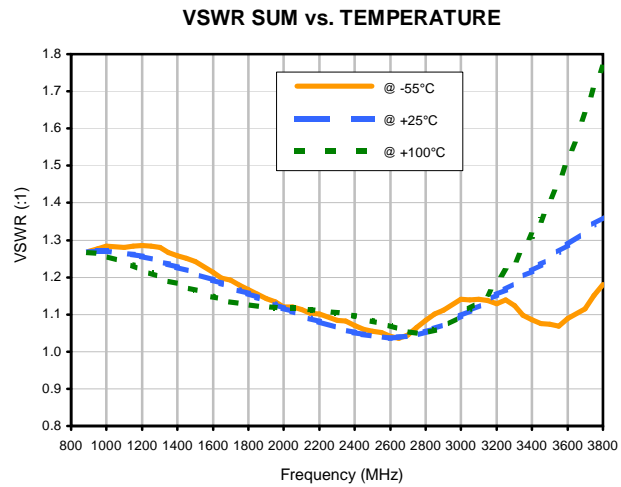
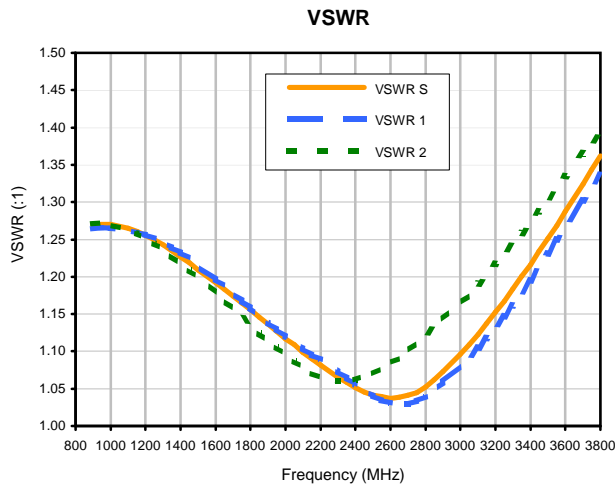

REV. X2
QCN-27+
100627
Page 2 of 2



The Design Engineers Search Engine finds the model you need, Instantly • For detailed performance specs & shopping online see minicircuits.com

IF/RF MICROWAVE COMPONENTS • ISO 9001 ISO 14001 AS 9100 CERTIFIED • RoHS compliant
P.O. Box 350166, Brooklyn, New York 11235-0003 (718) 934-4500 Fax (718) 332-4661

Mini-Circuits®

Outline Dimensions

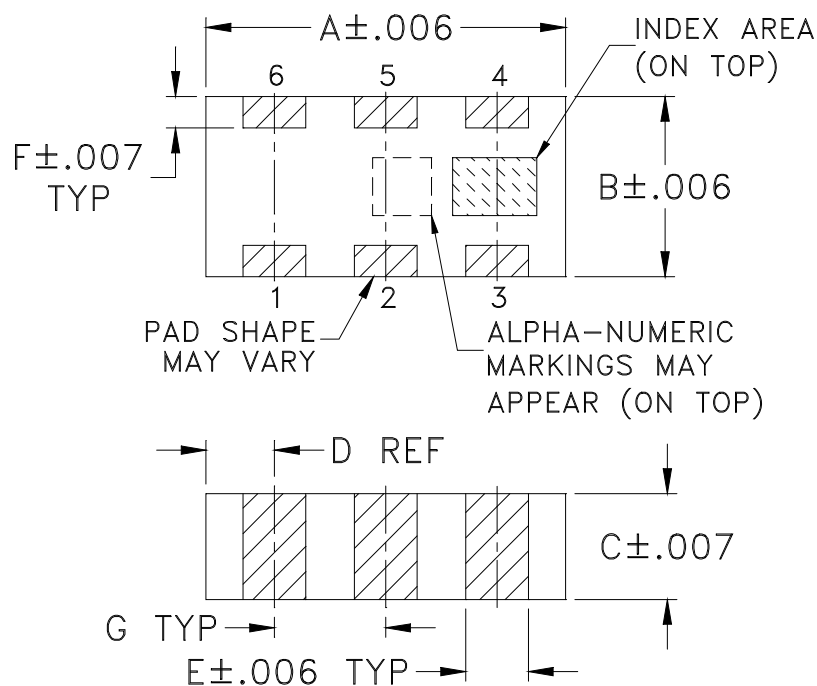

PCB Land Pattern

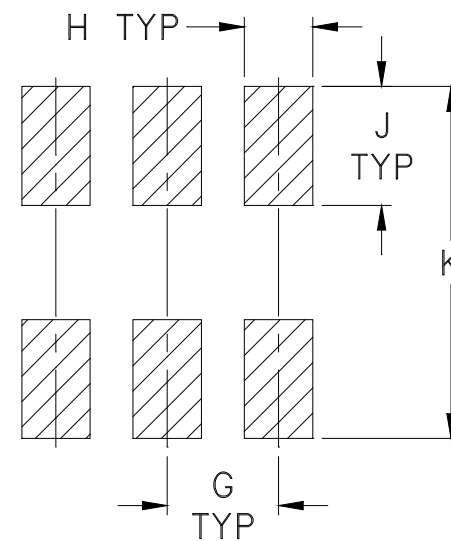

Suggested Layout,
Tolerance to be within $\pm.002$

CASE #	A	B	C	D	E	F	G	H	J	K	L	M	N	P	WT. GRAM
FV1206-1	.126 (3.20)	.063 (1.60)	.035 (0.89)	.024 (0.61)	.022 (0.56)	.011 (0.28)	.039 (0.99)	.024 (0.61)	.042 (1.07)	.123 (3.12)	--	--	--	--	.020

Dimensions are in inches (mm). Tolerances: 2 Pl. $\pm.01$; 3 Pl. $\pm.005$

Notes:

- Open style, ceramic base.
- Termination finish: **as shown below or indicated on Data Sheet.**
For RoHS Case Styles: Tin plate over Nickel plate. All models, (+) suffix.
For RoHS-5 Case Styles: Tin-Lead plate. All models, no (+) suffix.



P.O. Box 350166, Brooklyn, New York 11235-0003 (718) 934-4500 Fax (718) 332-4661 For detailed performance specs & shopping online see Mini-Circuits web site



The Design Engineers Search Engine Provides ACTUAL Data Instantly From MINI-CIRCUITS At: www.minicircuits.com

RF/IF MICROWAVE COMPONENTS

DEVICE ORIENTATION IN T&R

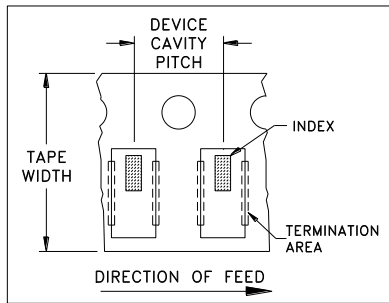

ILLUSTRATION 1

Applicable Case Styles

FV1206-1
FV1206-3

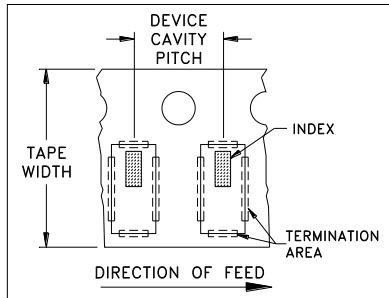

ILLUSTRATION 2

Applicable Case Styles

FV1206-4
FV1206-5
FV1206-6
FV1206-7
FV1206-9

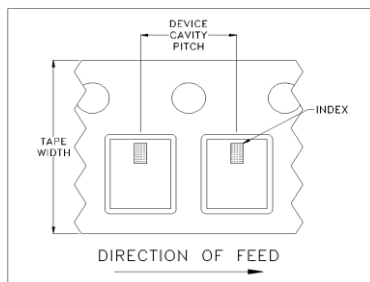

ILLUSTRATION 3

Applicable Case Styles

FV1206-12
GE0805C-18
NL1008C-6
NL1008C-7
NL1008C-9
NL1008C-10

Tape Width, mm	Device Cavity Pitch, mm	Reel Size, inches	Devices per Reel	
8	4	7	Small quantity standards (see note)	20
				50
				100
				200
				500
			1000	
			Standard	3000

Note: Please consult individual model data sheet to determine device per reel availability.

Mini-Circuits carrier tape materials provide protection from ESD (Electro-Static Discharge) during handling and transportation. Tapes are static dissipative and comply with industry standards EIA-481/EIA-541.

Go to: www.minicircuits.com/pages/pdfs/tape.pdf

Mini-Circuits ISO 9001 & ISO 14001 Certified

Mini-Circuits[®]

INTERNET <http://www.minicircuits.com>

P.O. Box 350166, Brooklyn, New York 11235-0003 (718) 934-4500 Fax (718) 332-4661

Distribution Centers NORTH AMERICA 800-654-7949 • 417-335-5935 • Fax 417-335-5945 • EUROPE 44-1252-832600 • Fax 44-1252-837010

Mini-Circuits ISO 9001 & ISO 14001 Certified

THIRD ANGLE PROJECTION

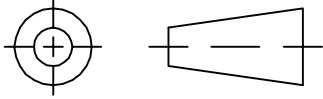

REVISIONS

REV	ECN No.	DESCRIPTION	DATE	DR	AUTH
OR	M87001	NEW RELEASE	05/20/03	MMG	ABD
A	M87231	CORRECTED DWG.	05/28/03	MMG	ABD
B	M91636	ADDED "pn" PIN CONNECTION	04/07/04	AV	ABD
C	M102713	ADDED "...WITH SMOBC"	01/16/06	GF	IL

**SUGGESTED MOUNTING CONFIGURATION
FOR FV1206-1 CASE STYLE, "pb/pn" PIN CONNECTIONS**

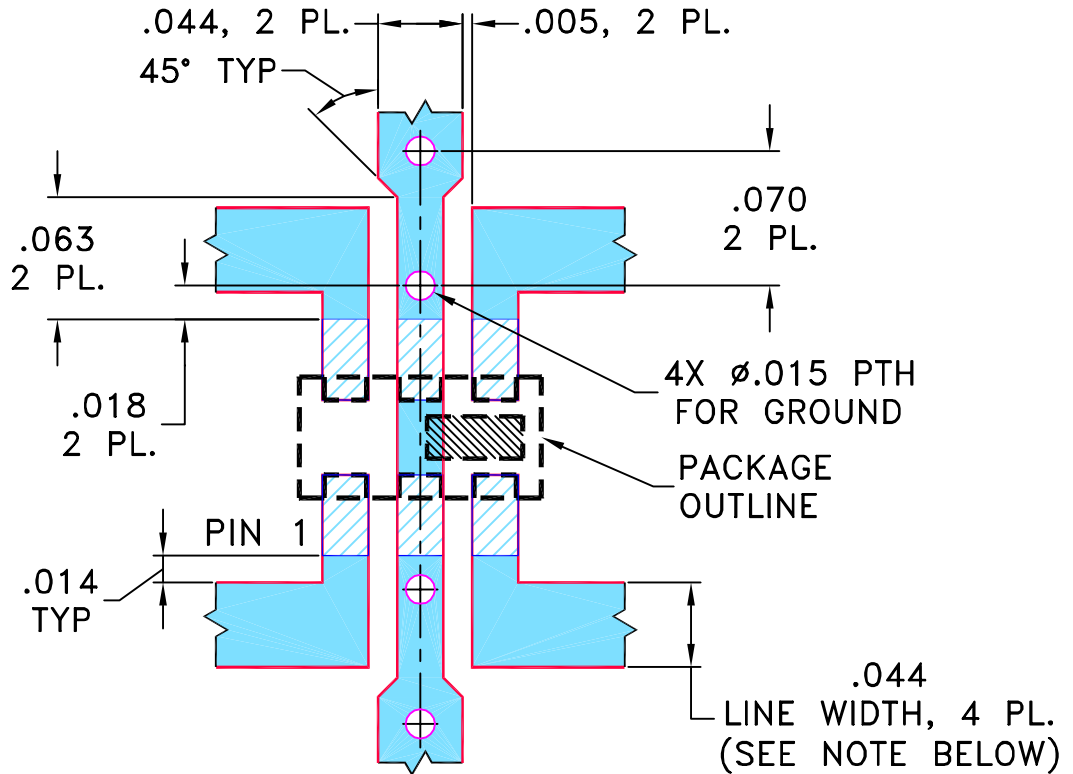

NOTES: 1. TRACE WIDTH IS SHOWN FOR ROGERS RO4350B WITH DIELECTRIC THICKNESS 0.020" ± 0.0015"; COPPER: 1/2 OZ. EACH SIDE. FOR OTHER MATERIALS TRACE WIDTH MAY NEED TO BE MODIFIED.

2. BOTTOM SIDE OF THE PCB IS CONTINUOUS GROUND PLANE.



DENOTES PCB COPPER LAYOUT WITH SMOBC (SOLDER MASK OVER BARE COPPER)

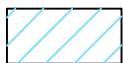

DENOTES COPPER LAND PATTERN FREE OF SOLDER MASK

UNLESS OTHERWISE SPECIFIED	INITIALS		DATE
DIMENSIONS ARE IN INCHES TOLERANCES ON: 2 PL DECIMALS ± 3 PL DECIMALS ± .005 ANGLES ± FRACTIONS ±	DRAWN	MMG	05/14/03
	CHECKED	AV	05/19/03
	APPROVED	ABD	05/20/03



Mini-Circuits®

13 Neptune Avenue
Brooklyn NY 11235

PL, pb/pn, FV1206-1, QCN/BDCN, TB-255

Mini-Circuits®
THIS DOCUMENT AND ITS CONTENTS ARE THE PROPERTY OF MINI-CIRCUITS. EXCEPT FOR USE EXPRESSLY GRANTED, IN WRITING, TO ITS VENDORS, VENDEE AND THE UNITED STATES GOVERNMENT, MINI-CIRCUITS RESERVES ALL PROPRIETARY DESIGN, USE, MANUFACTURING AND REPRODUCTION RIGHTS THERETO. THESE CONTENTS SHALL NOT BE USED, DUPLICATED OR DISCLOSED TO ANY OUTSIDE PARTY, IN WHOLE OR IN PART, WITHOUT WRITTEN PERMISSION OF MINI-CIRCUITS.

SIZE	CODE IDENT	DRAWING NO:	REV:
A	15542	98-PL-131	C
FILE:	98PL131	SCALE:	10:1
		SHEET:	1 OF 1

Evaluation Board and Circuit

For Pin Connections refer to Data Sheet of the DUT

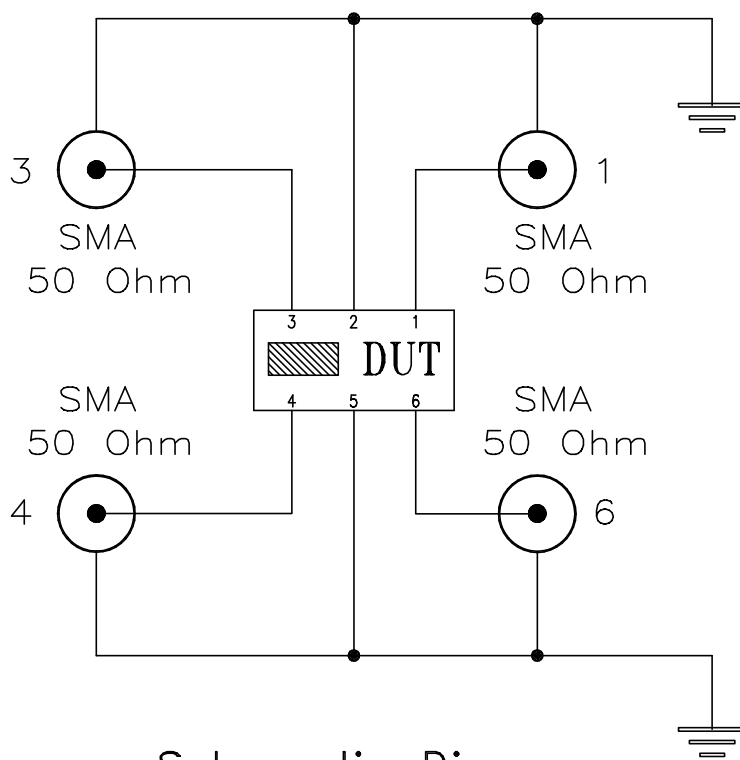
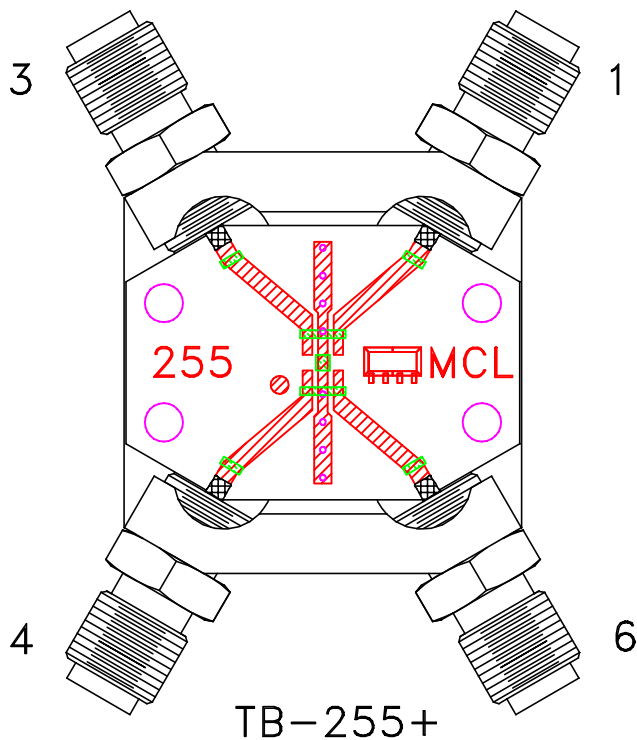

Schematic Diagram

Notes:

1. SMA Female connectors.
2. PCB Material: Rogers R04350 or equivalent, Dielectric Constant=3.5, Thickness=.020 inch.

 **Mini-Circuits®**

All Mini-Circuits products are manufactured under exacting quality assurance and control standards, and are capable of meeting published specifications after being subjected to any or all of the following physical and environmental test.

Specification	Test/Inspection Condition	Reference/Spec
Operating Temperature	-55° to 100°C Ambient Environment	Individual Model Data Sheet
Storage Temperature	-55° to 100° C Ambient Environment	Individual Model Data Sheet
Humidity	90 to 95% RH, 240 hours, 50°C	MIL-STD-202, Method 103, Condition A, Except 50°C and end-point electrical test done within 12 hours
Solder Reflow Heat	Sn-Pb Eutetic Process: 225°C peak Pb-Free Process 245° - 250°C peak	J-STD-020, Table 4-1, 4-2 and 5-2, Figure 5-1
Solderability	10X Magnification	J-STD-002, Para 4.2.5, Test S, 95% Coverage
Vibration (High Frequency)	20g peak, 10-2000 Hz, 12 times in each of three perpendicular directions (total 36)	MIL-STD-202, Method 204, Condition D
Mechanical Shock	50g, 11 ms, 1/2-sine, 18 shocks: 3 each direction, each of 3 axes	MIL-STD-202, Method 213, Condition A