

USB / Ethernet true RMS

# Smart Power Sensor

# PWR-6LRMS-RC

50Ω -45 dBm to +10 dBm, 50 to 6000 MHz

## The Big Deal

- **USB and Ethernet control**
- True RMS power sensor  
(Measure CW and modulated signals)
- Measure power levels as low as -45 dBm
- Fast Measurement rate: 30 ms



## Typical Applications

- Turn any Windows or Linux PC into a Power Meter
- Lab & benchtop testing
- Signal level calibration in production test systems
- Power monitoring in remote installations / base-stations
- Bluetooth / Wi-Fi / 2G /3G / 4G testing

Model No.	Description
<b>PWR-6LRMS-RC</b>	<b>USB/Ethernet smart True RMS Power Sensor</b>
<b>Included Accessories</b>	
PWRSN-6LRMS-RC	Power Sensor Head
USB-RJ45-CBL-7+	6.6 ft "Y" data cable (USB & RJ45)

**FC, CE, UK & RoHS Compliant**  
See our web site for RoHS Compliance methodologies and qualifications

## Product Overview

Mini-Circuits' PWR-6LRMS-RC is a low cost, compact sensor-head that turns any PC with a USB port into a true RMS power meter for CW (continuous waveform), modulated and multi-tone signals. The sensor has a 55 dB input dynamic range allowing measurement of RF powers down to -45 dBm, over 50 to 6000 MHz.

The USB HID interface is "plug & play" compatible, meaning no driver installation is required. Full software support is provided, including our user-friendly GUI application for Windows and a full API with programming instructions for Windows and Linux environments (both 32-bit and 64-bit systems).

Download from <http://www.minicircuits.com/softwaredownload/pm.html>

## Key Features

Feature	Advantages
True RMS	Allows measurement of CW, modulated and multi tone signals
USB & Ethernet control	USB HID and Ethernet (HTTP / Telnet) interfaces provide easy compatibility with a wide range of software setups and programming environments
Automatic measurement compensation	Power measurements are automatically adjusted by the sensor to maintain accuracy with variations in the ambient temperature and across the bandwidth of the sensor
No User calibration required	Accurate power measurements can commence as soon as the sensor is connected since it does not require any zero or reference measurements
Excellent impedance match	Input VSWR of 1.10:1 typ reduces measurement errors due to impedance mismatch

**Trademarks:** Windows is a registered trademark of Microsoft Corporation in the United States and other countries. Linux is a registered trademark of Linus Torvalds. Pentium is a registered trademark of Intel Corporation. Neither Mini-Circuits nor the Mini-Circuits PWR-series power sensors are affiliated with or endorsed by the owners of the above referenced trademarks

Mini-Circuits and the Mini-Circuits logo are registered trademarks of Scientific Components Corporation.



[www.minicircuits.com](http://www.minicircuits.com) P.O. Box 35166, Brooklyn, NY 11235-0003 (718) 934-4500 sales@minicircuits.com

Rev. F  
ECO-021930  
EDR-11185/1  
PWR-6LRMS-RC  
MCIL  
240529  
Page 1 of 9

**Electrical Specifications, -45 dBm to +10 dBm, 50 to 6000 MHz**

Parameter		Freq. Range (MHz)	Min.	Typ.	Max.	Units
Dynamic Range <sup>1</sup>		50 - 6000	-45	-	+10	dBm
VSWR		50 - 6000	-	1.10	1.30	:1
Uncertainty of Power Measurement <sup>2</sup> @ 25°C	@ -45 to -40 dBm <sup>3,4</sup>	50 - 3000	-	±0.15	±0.40	dB
		3000 - 6000	-	±0.20	±0.45	dB
	@ -40 to -10 dBm	50 - 3000	-	±0.15	±0.30	dB
		3000 - 6000	-	±0.15	±0.30	dB
	@ -10 to +10 dBm	50 - 3000	-	±0.15	±0.30	dB
		3000 - 6000	-	±0.15	±0.30	dB
Uncertainty of Power Measurement <sup>2</sup> @ 0°C to 50°C	@ -45 to -40 dBm <sup>3,4</sup>	50 - 3000	-	±0.15	-	dB
		3000 - 6000	-	±0.20	-	dB
	@ -40 to -10 dBm	50 - 3000	-	±0.15	-	dB
		3000 - 6000	-	±0.15	-	dB
	@ -10 to +10 dBm	50 - 3000	-	±0.15	-	dB
		3000 - 6000	-	±0.15	-	dB
Linearity @ 25°C		50 - 6000	-	± 1.6	-	%
Measurement Resolution		50 - 6000	0.01	-	-	dB
Averaging Range		50 - 6000	1	-	999	-
Measurement Speed	@ Low Noise Mode	50 - 6000	-	100	-	msec
	@ Faster Mode		-	30	-	
Current (via host USB)		50 - 6000	-	230	300	mA

<sup>1</sup> Maximum continuous safe operational power limit: +13 dBm. Performance is guaranteed up to +10 dBm.

<sup>2</sup> Tested with CW signal

<sup>3</sup> When using Faster mode at high frequencies below -30dBm, use of averaging is recommended to prevent noise errors.

<sup>4</sup> When using Faster mode below -30dBm, uncertainty value may increase by up to 0.2 dB relative to Low noise mode

**Electrical Specifications (Continued), -45 dBm to +10 dBm, 50 to 6000 MHz**

Parameter		Freq. Range (MHz)	Min.	Typ.	Max.	Units	
Uncertainty of Power Measurement (digital modulation) <sup>5</sup> @ 25°C	QPSK, QAM16 & QAM64 in LTE uplink setup (1.4 MHz channels, 3.7 MHz offsets)	@ -40 dBm	50 - 1000 & 1500 - 6000	-	±0.35	-	dB
		@ -30 dBm	-	±0.25	-		
		@ -15 dBm	-	±0.25	-		
		@ 0 dBm	-	±0.40	-		
	QPSK in WiMax setup (10MHz channel, 22.4MHz sample clock)	@ -40 dBm	2000 - 6000	-	±0.35	-	dB
		@ -30 dBm	-	±0.30	-		
		@ -15 dBm	-	±0.50	-		
		@ 0 dBm	-	±0.30	-		
	64QAM in WLAN setup (10MHz channel, 22.4MHz sample clock)	@ -40 dBm	2000 - 6000	-	±0.35	-	dB
		@ -30 dBm	-	±0.25	-		
		@ -15 dBm	-	±0.4	-		
		@ 0 dBm	-	±0.35	-		
	MSK in GSM setup (Gaussian filter @270,833 sps)	@ -40 dBm	50 - 6000	-	±0.35	-	dB
		@ -30 dBm	-	±0.30	-		
		@ -15 dBm	-	±0.30	-		
		@ 0 dBm	-	±0.30	-		
	DQPSK in NADC setup (RNYQ filter@24.3 ksps)	@ -40 dBm	50 - 6000	-	±0.30	-	dB
		@ -30 dBm	-	±0.25	-		
		@ -15 dBm	-	±0.25	-		
		@ 0 dBm	-	±0.30	-		
	DQPSK in PWT setup (RNYQ filter@576 ksps)	@ -40 dBm	50 - 6000	-	±0.35	-	dB
		@ -30 dBm	-	±0.25	-		
		@ -15 dBm	-	±0.20	-		
		@ 0 dBm	-	±0.25	-		
	256QAM in DECT setup (Gaussian filter@1.152Msps)	@ -40 dBm	50 - 6000	-	±0.35	-	dB
		@ -30 dBm	-	±0.30	-		
		@ -15 dBm	-	±0.30	-		
		@ 0 dBm	-	±0.30	-		
4QAM in PHS setup (RNYQ filter@192ksps)	@ -40 dBm	50 - 6000	-	±0.35	-	dB	
	@ -30 dBm	-	±0.35	-			
	@ -15 dBm	-	±0.30	-			
	@ 0 dBm	-	±0.35	-			
Pulse Modulation, modulating signal frequency <sup>6</sup>		50 - 6000	0.5	-	100	kHz	
Effect of multi-tone signals (within span of 15 MHz) <sup>7,8</sup>		50 - 100	-	±0.1	±0.3	dB	
Effect of multi-tone signals (within span of 50 MHz) <sup>7,8</sup>		100 - 6000	-	±0.1	±0.3		

<sup>5</sup> Digital modulation transmission rates are measured in 'symbols per second' (sps) and use a bandpass filter on the output to limit spectral spreading.

<sup>6</sup> Tested with 30% duty cycle.

<sup>7</sup> Relative to an equivalent CW signal @+25°C

<sup>8</sup> Tested at -40 to 0 dBm @+25°C average modulated power. Be careful that peak power does not exceed specified Maximum power.

## Absolute Maximum Ratings

Parameter	Ratings
Operating Temperature	0°C to 50°C
Storage Temperature	-30°C to 70°C
DC Voltage at RF port	16 V
CW Power	+15 dBm

## Outline Drawing (JL1941)

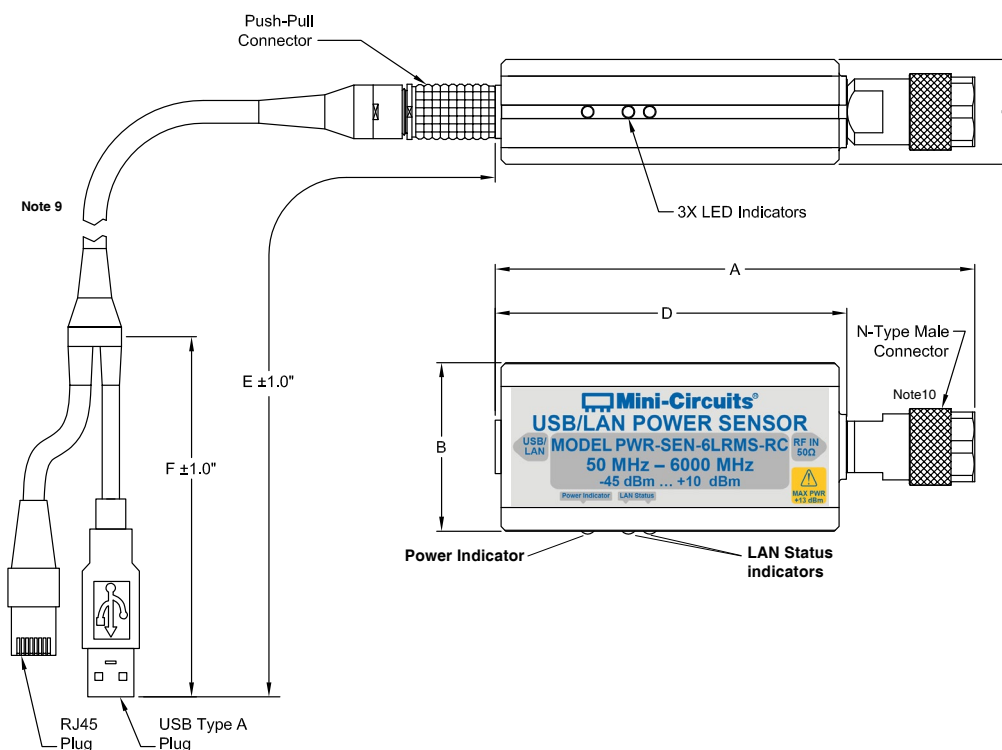

## Outline Dimensions ( $\frac{\text{inch}}{\text{mm}}$ )

A	B	C	D	E	F	WT. GRAMS
4.95	1.74	1.08	3.63	81.0	20.0	250
125.7	44.2	27.4	92.2	2057	508	

<sup>9</sup> Power sensor to be used with the supplied control cable only.

<sup>10</sup> Maximum torque 8 in-lb (90 N-cm).

Typical Performance Curves

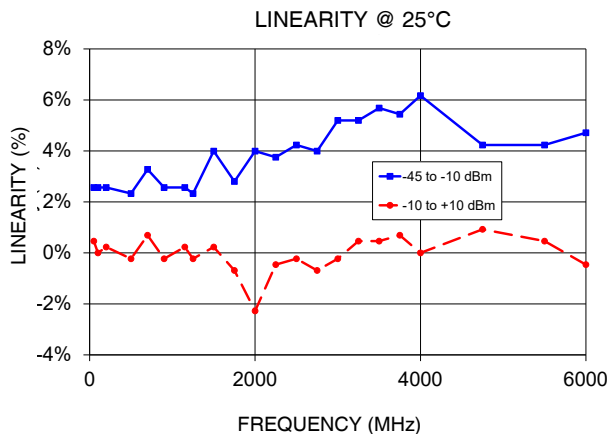
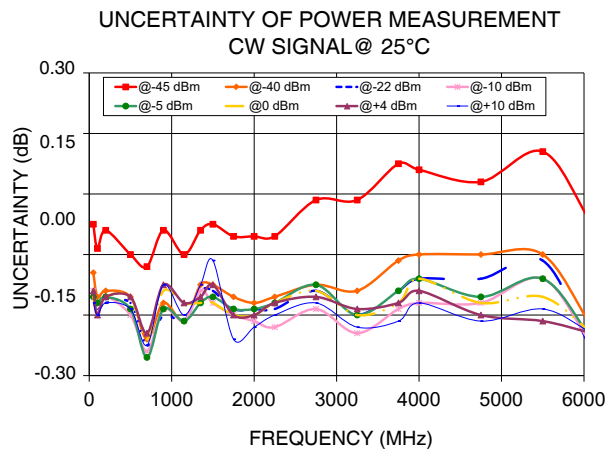
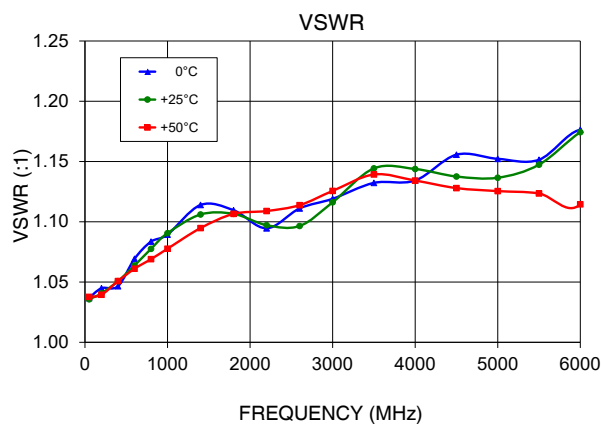

Typical Performance Curves (Continued)

UNCERTAINTY OF POWER MEASUREMENT  
MODULATED SIGNALS @ 25°C, -40 dBm

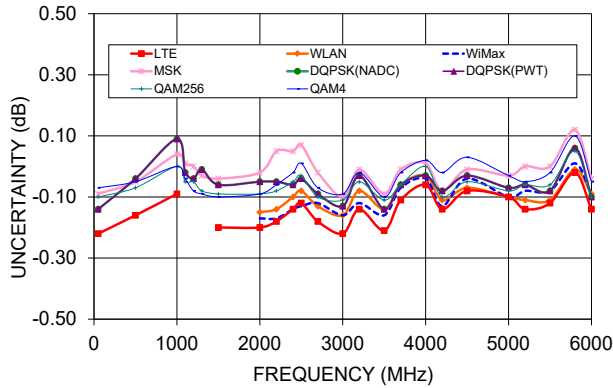

UNCERTAINTY OF POWER MEASUREMENT  
MODULATED SIGNALS @ 25°C, -30 dBm

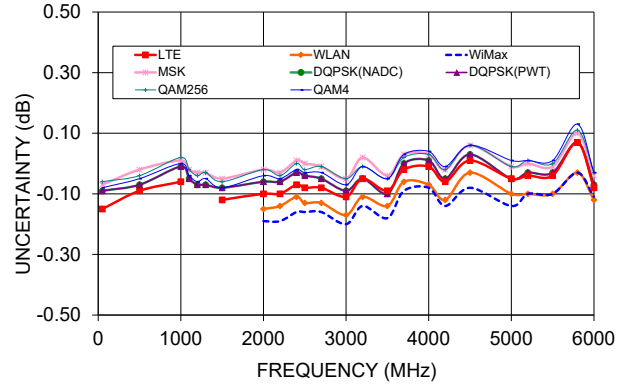

UNCERTAINTY OF POWER MEASUREMENT  
MODULATED SIGNALS @ 25°C, -15 dBm

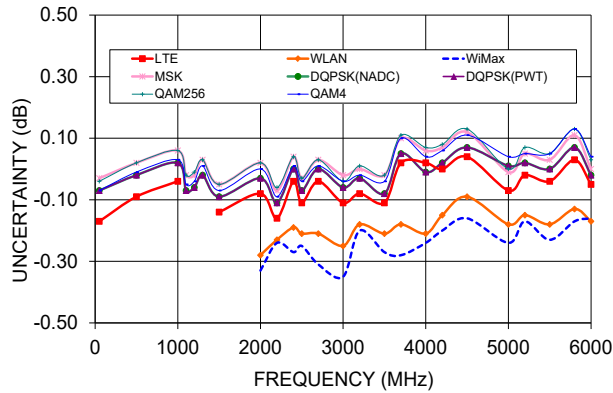

UNCERTAINTY OF POWER MEASUREMENT  
MODULATED SIGNALS @ 25°C, 0 dBm

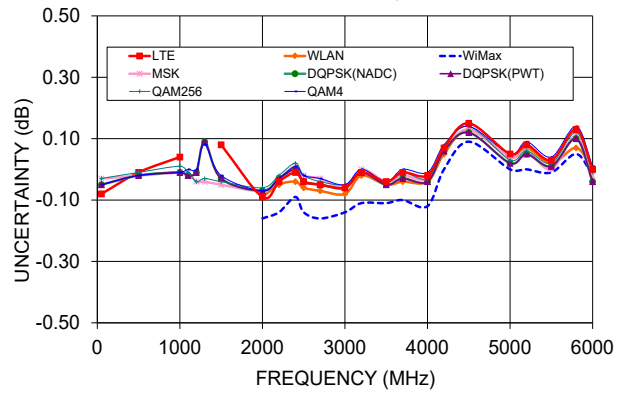

## Connection diagrams

### Connection diagram for USB control

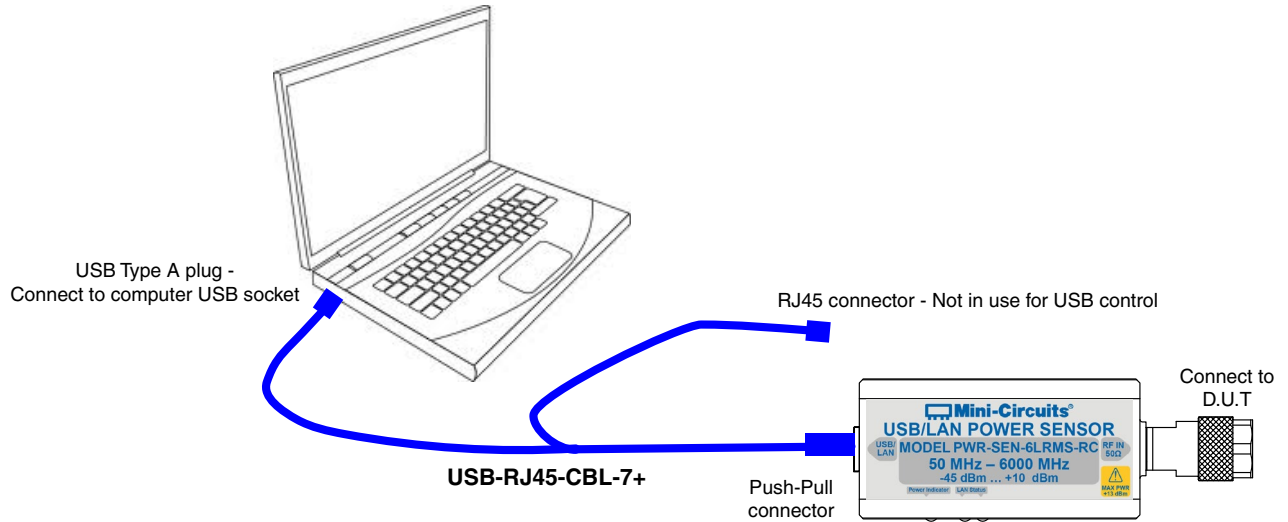

### Connection diagram for Ethernet control, using power adaptor

Connect USB-AC/DC-5 to mains power

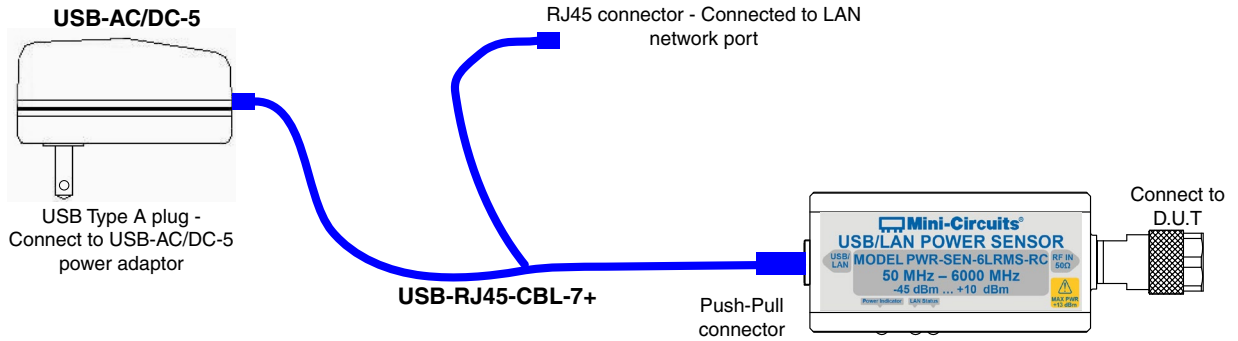

### Connection diagram for Ethernet control, using PoE system

Note: Commercially available PoE splitter not supplied by Mini-Circuits

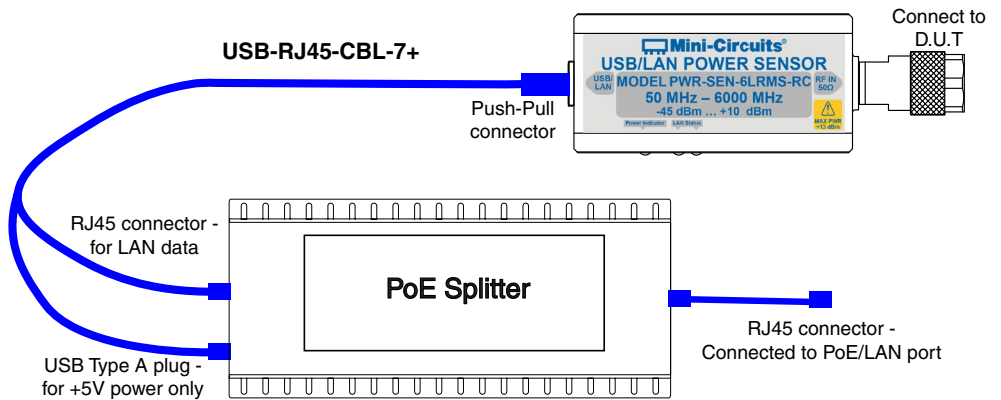

## Software & Documentation Download:

- Mini-Circuits' full software and support package including user guide, Windows GUI, DLL files, programming manual and examples can be downloaded free of charge from <http://www.minicircuits.com/softwaredownload/pm.html>.
- Please contact [testsolutions@minicircuits.com](mailto:testsolutions@minicircuits.com) for support

## Minimum System Requirements

Parameter	Requirements	
Interface	USB HID or HTTP Get/Post or Telnet protocols	
System requirements	GUI:	Windows 32 & 64 bit systems from Windows 98 up to Windows 10
	USB API (ActiveX & .Net)	Windows 32 & 64 bit systems with ActiveX or .Net support from Windows 98 up to Windows 10
	USB direct programming support	Linux, Windows systems from Windows 98 up to Windows 10
	HTTP or Telnet	Any computer with a network port and Ethernet-TCP/IP (HTTP or Telnet protocols) support
Hardware	Pentium® II or higher, RAM 256 MB	
Y control cable for USB and Ethernet (supplied)	Power sensor to be used with the supplied control cable only	

## Graphical User Interface (GUI) for Windows

### Key Features:

- Set compensation frequency and monitor power measurement
- Configure measurement offsets and relative power readings
- Set measurement mode (speed and averaging)
- Control multiple power sensors at once
- Schedule data recording
- Guided measurements for a variety of applications (characterizing a two port device, power monitoring, etc.)

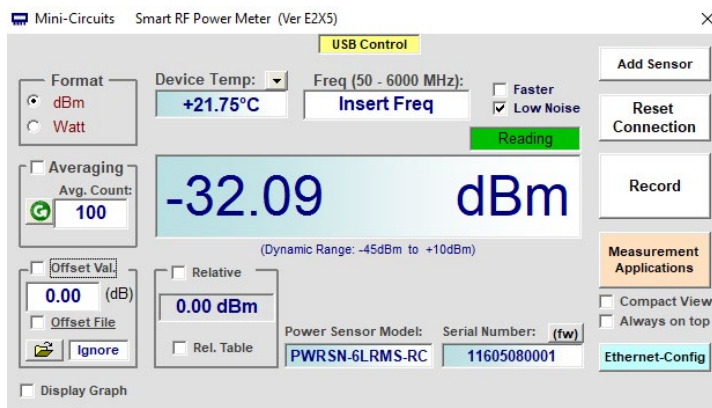

## Application Programming Interface (API)

### Windows Support:

- API DLL files exposing the full power sensor functionality. See programming manual at [https://www.minicircuits.com/softwaredownload/Prog\\_Manual-4-Power\\_Meter.pdf](https://www.minicircuits.com/softwaredownload/Prog_Manual-4-Power_Meter.pdf) for details.
  - ActiveX COM DLL file for creation of 32-bit programs
  - .Net library DLL file for creation of 32 / 64-bit programs
- Supported by most common programming environments (refer to application note [AN-49-001](#) for summary of tested environments)

### Linux Support:



- Full power sensor control in a Linux environment is achieved by way of USB interrupt commands. See programming manual at [https://www.minicircuits.com/softwaredownload/Prog\\_Manual-4-Power\\_Meter.pdf](https://www.minicircuits.com/softwaredownload/Prog_Manual-4-Power_Meter.pdf) for details.





## Ordering Information

Model	Description
PWR-6LRMS-RC	USB/Ethernet <i>Smart</i> True RMS Power Sensor

Included Accessories	Part No.	Description
	PWRSN-6LRMS-RC	Power Sensor Head
	USB-RJ45-CBL-7+	6.6 ft (2 m) "Y" data cable with USB Type-A and RJ45 plug connectors <sup>11</sup>

<sup>11</sup> Power sensor to be used with the supplied control cable only.

Optional Accessories	Description
USB-AC/DC-5+	AC/DC 5V <sub>DC</sub> Power Adapter with US, EU, IL, UK, AUS, and China power plugs <sup>12</sup>
USB-RJ45-CBL-7+ (spare)	6.6 ft (2 m) "Y" data cable with USB Type-A and RJ45 plug connectors
NF-SM50+	N-Type Female to SMA Male Adapter.
NF-SF50+	N-Type Female to SMA Female Adapter
NF-BM50+	N-Type Female to BNC Male Adapter.

<sup>12</sup> Power plugs for other countries are also available, Plugs for other countries are also available, if you need a power plug for a country not listed please contact [testsolutions@minicircuits.com](mailto:testsolutions@minicircuits.com).

Calibration	Description
CALSN-6LRMS-RC	Calibration Service <a href="#">Click Here</a>

## Additional Notes

- A. Performance and quality attributes and conditions not expressly stated in this specification document are intended to be excluded and do not form a part of this specification document.
- B. Electrical specifications and performance data contained in this specification document are based on Mini-Circuit's applicable established test performance criteria and measurement instructions.
- C. The parts covered by this specification document are subject to Mini-Circuits standard limited warranty and terms and conditions (collectively, "Standard Terms"); Purchasers of this part are entitled to the rights and benefits contained therein. For a full statement of the Standard Terms and the exclusive rights and remedies thereunder, please visit Mini-Circuits' website at [www.minicircuits.com/MCLStore/terms.jsp](http://www.minicircuits.com/MCLStore/terms.jsp)

## Typical Performance Data

FREQ. (MHz)	VSWR (:1)		
	0°C	+25°C	+50°C
1.00	1.04	1.04	1.04
10.00	1.04	1.04	1.04
20.00	1.04	1.04	1.04
50.00	1.04	1.04	1.04
100.00	1.04	1.04	1.04
200.00	1.04	1.04	1.04
300.00	1.04	1.05	1.04
400.00	1.05	1.05	1.05
500.00	1.06	1.06	1.06
600.00	1.07	1.06	1.06
700.00	1.08	1.07	1.06
800.00	1.08	1.08	1.07
900.00	1.09	1.08	1.07
1000.00	1.09	1.09	1.08
1200.00	1.11	1.10	1.09
1400.00	1.11	1.11	1.09
1600.00	1.11	1.11	1.10
1800.00	1.11	1.11	1.11
2000.00	1.10	1.10	1.11
2200.00	1.09	1.10	1.11
2400.00	1.10	1.09	1.11
2600.00	1.11	1.10	1.11
2800.00	1.11	1.10	1.12
3000.00	1.12	1.12	1.13
3250.00	1.13	1.13	1.13
3500.00	1.13	1.14	1.14
3750.00	1.13	1.15	1.14
4000.00	1.13	1.14	1.13
4250.00	1.15	1.14	1.13
4500.00	1.16	1.14	1.13
4750.00	1.15	1.14	1.13
5000.00	1.15	1.14	1.13
5250.00	1.15	1.14	1.12
5500.00	1.15	1.15	1.12
5750.00	1.16	1.16	1.11
6000.00	1.18	1.17	1.11
6250.00	1.18	1.19	1.15
6500.00	1.16	1.19	1.18
7000.00	1.18	1.17	1.20
7500.00	1.11	1.11	1.17

**Notes**

- A. Performance and quality attributes and conditions not expressly stated in this specification document are intended to be excluded and do not form a part of this specification document.
- B. Electrical specifications and performance data contained in this specification document are based on Mini-Circuits' applicable established test performance criteria and measurement instructions.
- C. The parts covered by this specification document are subject to Mini-Circuits' standard limited warranty and terms and conditions (collectively, "Standard Terms"); Purchasers of this part are entitled to the rights and benefits contained therein. For a full statement of the Standard Terms and the exclusive rights and remedies thereunder, please visit Mini-Circuits' website at [www.minicircuits.com/MCLStore/terms.jsp](http://www.minicircuits.com/MCLStore/terms.jsp)



## Typical Performance Data

LINEARITY @ -35 to 0 dBm	
FREQ (MHz)	- (%)
40	2.33
50	2.57
67	3.51
82	2.80
100	2.57
200	2.57
284	3.28
350	3.04
388	2.80
500	2.33
576	2.33
650	3.28
700	3.28
786	3.51
850	3.04
900	2.57
1150	2.57
1250	2.33
1350	3.04
1500	3.99
1650	3.04
1750	2.80
1850	3.28
2000	3.99
2150	3.51
2250	3.75
2500	4.23
2750	3.99
3000	5.20
3250	5.20
3500	5.68
3750	5.44
3850	5.20
4000	6.17
4500	4.71
4750	4.23
5250	4.95
5500	4.23
6000	4.71
6100	5.20

LINEARITY @ 0 to +20 dBm	
FREQ (MHz)	- (%)
40	0.46
50	0.46
67	0.69
82	0.46
100	0.00
200	0.23
284	-1.60
350	-1.83
388	-1.83
500	-0.23
576	-0.23
650	-0.23
700	0.69
786	-0.46
850	-0.92
900	-0.23
1150	0.23
1250	-0.23
1350	-1.60
1500	0.23
1650	0.93
1750	-0.69
1850	0.23
2000	-2.28
2150	-0.46
2250	-0.46
2500	-0.23
2750	-0.69
3000	-0.23
3250	0.46
3500	0.46
3750	0.69
3850	0.00
4000	0.00
4500	0.69
4750	0.93
5250	1.16
5500	0.46
6000	-0.46
6100	-0.69

**Notes**

- A. Performance and quality attributes and conditions not expressly stated in this specification document are intended to be excluded and do not form a part of this specification document.
- B. Electrical specifications and performance data contained in this specification document are based on Mini-Circuits' applicable established test performance criteria and measurement instructions.
- C. The parts covered by this specification document are subject to Mini-Circuits' standard limited warranty and terms and conditions (collectively, "Standard Terms"); Purchasers of this part are entitled to the rights and benefits contained therein. For a full statement of the Standard Terms and the exclusive rights and remedies thereunder, please visit Mini-Circuits' website at [www.minicircuits.com/MCLStore/terms.jsp](http://www.minicircuits.com/MCLStore/terms.jsp)



## Typical Performance Data

FREQ. (MHz)	UNCERTAINTY OF POWER MEASUREMENTS AT CW @ 25°C (dB)							
	-45	-40	-22	-10	-5	0	+4	+10
40	0.63	0.56	0.52	0.53	0.53	0.53	0.53	0.51
50	0.15	0.07	0.04	0.04	0.03	0.03	0.04	0.02
67	0.16	0.05	0.02	0.01	0.02	0.01	0.01	-0.02
82	0.14	0.04	0.02	0.02	0.02	0.01	0.01	0.00
100	0.11	0.03	0.01	0.00	0.02	0.00	0.00	0.00
200	0.14	0.04	0.02	0.03	0.03	0.03	0.03	0.02
284	0.14	0.04	0.01	0.00	0.00	0.00	0.02	0.07
350	0.07	-0.01	-0.05	-0.06	-0.05	-0.04	-0.03	0.02
388	0.06	-0.03	-0.04	-0.06	-0.05	-0.04	-0.03	0.02
500	0.10	0.03	0.02	0.00	0.01	0.03	0.03	0.01
576	0.00	-0.09	-0.11	-0.10	-0.11	-0.08	-0.08	-0.09
650	0.08	-0.04	-0.05	-0.06	-0.07	-0.04	-0.03	-0.05
700	0.14	0.02	-0.01	0.00	-0.05	-0.01	0.01	-0.03
786	0.17	0.03	0.02	0.02	0.00	0.04	0.06	0.04
850	0.14	0.02	0.00	0.01	0.01	0.04	0.05	0.05
900	0.10	-0.01	-0.01	-0.01	-0.01	0.02	0.02	0.00
1150	0.12	0.02	0.02	0.01	0.01	0.02	0.00	0.00
1250	0.14	0.05	0.04	0.04	0.02	0.02	0.03	0.05
1350	0.15	0.05	0.04	0.02	0.03	0.02	0.05	0.09
1500	0.16	0.04	0.01	-0.01	0.00	0.00	0.01	-0.02
1650	0.13	0.03	0.01	0.00	0.01	0.00	0.00	-0.04
1750	0.11	0.01	0.02	-0.01	0.02	0.01	0.02	0.02
1850	0.13	0.02	0.01	-0.01	0.01	0.00	0.00	-0.02
2000	0.21	0.09	0.04	0.04	0.09	0.09	0.09	0.14
2150	0.13	0.03	0.01	-0.02	0.02	0.02	0.02	0.00
2250	0.16	0.02	0.01	0.00	0.03	0.03	0.05	0.02
2500	0.19	0.05	0.04	0.01	0.05	0.04	0.03	0.02
2750	0.18	0.07	0.04	0.01	0.04	0.05	0.04	0.04
3000	0.19	0.04	0.00	-0.03	0.00	0.00	0.01	-0.02
3250	0.20	0.01	-0.01	-0.02	-0.01	-0.01	-0.02	-0.04
3500	0.25	0.09	0.04	0.01	0.04	0.02	0.02	-0.01
3750	0.25	0.09	0.05	0.02	0.04	0.03	0.03	-0.01
3850	0.24	0.10	0.06	0.02	0.06	0.06	0.04	0.02
4000	0.23	0.04	0.00	-0.03	0.00	0.00	-0.01	-0.03
4500	0.22	0.10	0.06	0.02	0.03	0.02	0.00	-0.01
4750	0.21	0.08	0.05	0.03	0.05	0.01	0.00	-0.01
5250	0.27	0.10	0.09	0.06	0.06	0.03	-0.01	0.01
5500	0.16	0.00	-0.01	-0.02	-0.02	-0.03	-0.04	-0.04
6000	0.15	-0.02	-0.06	-0.05	-0.04	-0.03	-0.03	-0.03
6100	0.15	-0.02	-0.06	-0.07	-0.05	-0.04	-0.04	-0.04

**Notes**

- A. Performance and quality attributes and conditions not expressly stated in this specification document are intended to be excluded and do not form a part of this specification document.
- B. Electrical specifications and performance data contained in this specification document are based on Mini-Circuits' applicable established test performance criteria and measurement instructions.
- C. The parts covered by this specification document are subject to Mini-Circuits' standard limited warranty and terms and conditions (collectively, "Standard Terms"); Purchasers of this part are entitled to the rights and benefits contained therein. For a full statement of the Standard Terms and the exclusive rights and remedies thereunder, please visit Mini-Circuits' website at [www.minicircuits.com/MCLStore/terms.jsp](http://www.minicircuits.com/MCLStore/terms.jsp)



## UNCERTAINTY OF POWER MEASUREMENT MODULATED SIGNAL @ 25°C

FREQ. (MHZ)	LTE	DQPSK (PWT)	4QAM	DQPSK (NADC)	256 QAM	MSK	WLAN	WiMax
(dB)								
50	-0.22	-0.13	-0.07	-0.14	-0.10	-0.09	-	-
500	0.00	-0.09	-0.05	-0.04	-0.07	-0.05	-	-
1000	-0.09	-0.02	0.00	0.09	0.00	0.04	-	-
1100	-	-0.04	-0.04	-0.02	-0.05	0.01	-	-
1200	-	-0.07	-0.08	-0.04	-0.05	0.00	-	-
1300	-	-0.10	-0.09	-0.01	-0.08	-0.03	-	-
1500	-0.20	-0.15	-0.10	-0.06	-0.09	-0.04	-	-
2000	-0.20	-0.12	-0.09	-0.05	-0.09	-0.02	-0.15	-0.17
2200	-0.18	-0.11	-0.06	-0.05	-0.08	0.05	-0.14	-0.17
2400	-0.14	-0.09	-0.02	-0.06	-0.05	0.05	-0.10	-0.14
2500	-0.12	-0.07	0.01	-0.04	-0.03	0.07	-0.08	-0.13
2700	-0.18	-0.10	-0.07	-0.09	-0.10	-0.02	-0.13	-0.12
3000	-0.22	-0.17	-0.09	-0.13	-0.11	-0.10	-0.16	-0.16
3200	-0.14	-0.10	-0.02	-0.03	-0.05	-0.01	-0.08	-0.12
3500	-0.21	-0.15	-0.10	-0.14	-0.11	-0.09	-0.14	-0.16
3700	-0.11	-0.06	-0.02	-0.06	-0.06	-0.01	-0.06	-0.07
4000	-0.06	-0.03	0.02	-0.03	0.00	0.01	-0.03	-0.04
4200	-0.14	-0.12	-0.02	-0.08	-0.10	-0.08	-0.11	-0.13
4500	-0.08	-0.05	0.03	-0.03	-0.05	-0.01	-0.07	-0.04
5000	-0.10	-0.10	-0.03	-0.07	-0.08	-0.03	-0.10	-0.10
5200	-0.14	-0.13	-0.05	-0.06	-0.06	0.00	-0.11	-0.08
5500	-0.12	-0.12	-0.02	-0.08	-0.06	0.00	-0.11	-0.08
5800	-0.02	-0.01	0.10	0.06	0.05	0.12	-0.01	0.01
6000	-0.14	-0.15	-0.05	-0.10	-0.10	-0.04	-0.09	-0.09

**Notes**

- A. Performance and quality attributes and conditions not expressly stated in this specification document are intended to be excluded and do not form a part of this specification document.
- B. Electrical specifications and performance data contained in this specification document are based on Mini-Circuits' applicable established test performance criteria and measurement instructions.
- C. The parts covered by this specification document are subject to Mini-Circuits' standard limited warranty and terms and conditions (collectively, "Standard Terms"); Purchasers of this part are entitled to the rights and benefits contained therein. For a full statement of the Standard Terms and the exclusive rights and remedies thereunder, please visit Mini-Circuits' website at [www.minicircuits.com/MCLStore/terms.jsp](http://www.minicircuits.com/MCLStore/terms.jsp)



## Typical Performance Curves

VSWR

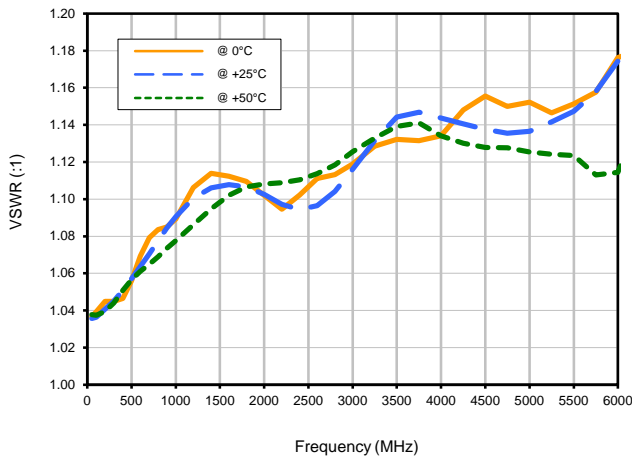

UNCERTAINTY OF POWER MEASUREMENT  
CW SIGNAL @ 25°C

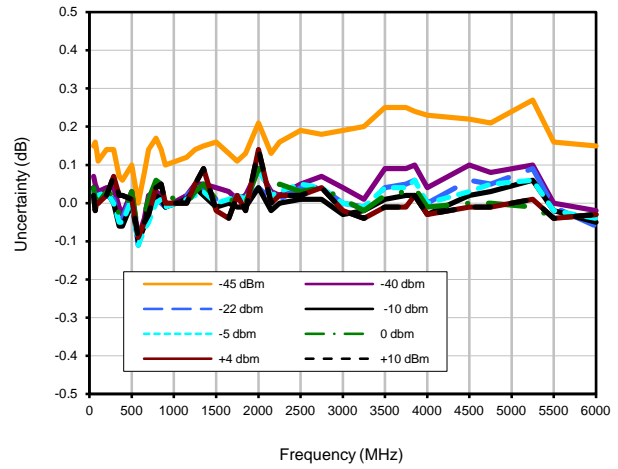

LINEARITY @ 25°C

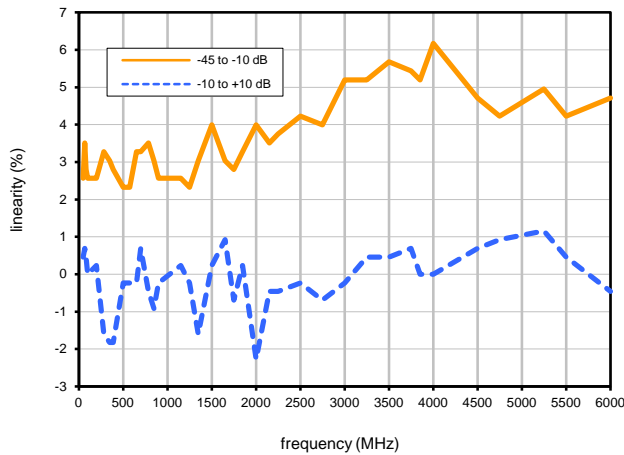

UNCERTAINTY OF POWER MEASUREMENT  
MODULATED SIGNAL @ 25°C

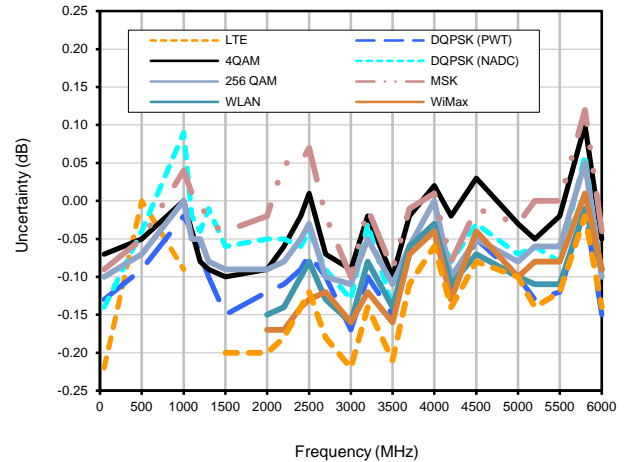

**Notes**

- A. Performance and quality attributes and conditions not expressly stated in this specification document are intended to be excluded and do not form a part of this specification document.
- B. Electrical specifications and performance data contained in this specification document are based on Mini-Circuits' applicable established test performance criteria and measurement instructions.
- C. The parts covered by this specification document are subject to Mini-Circuits' standard limited warranty and terms and conditions (collectively, "Standard Terms"); Purchasers of this part are entitled to the rights and benefits contained therein. For a full statement of the Standard Terms and the exclusive rights and remedies thereunder, please visit Mini-Circuits' website at [www.minicircuits.com/MCLStore/terms.jsp](http://www.minicircuits.com/MCLStore/terms.jsp)



# Case Style

# JL

## Outline Dimensions

## JL1941

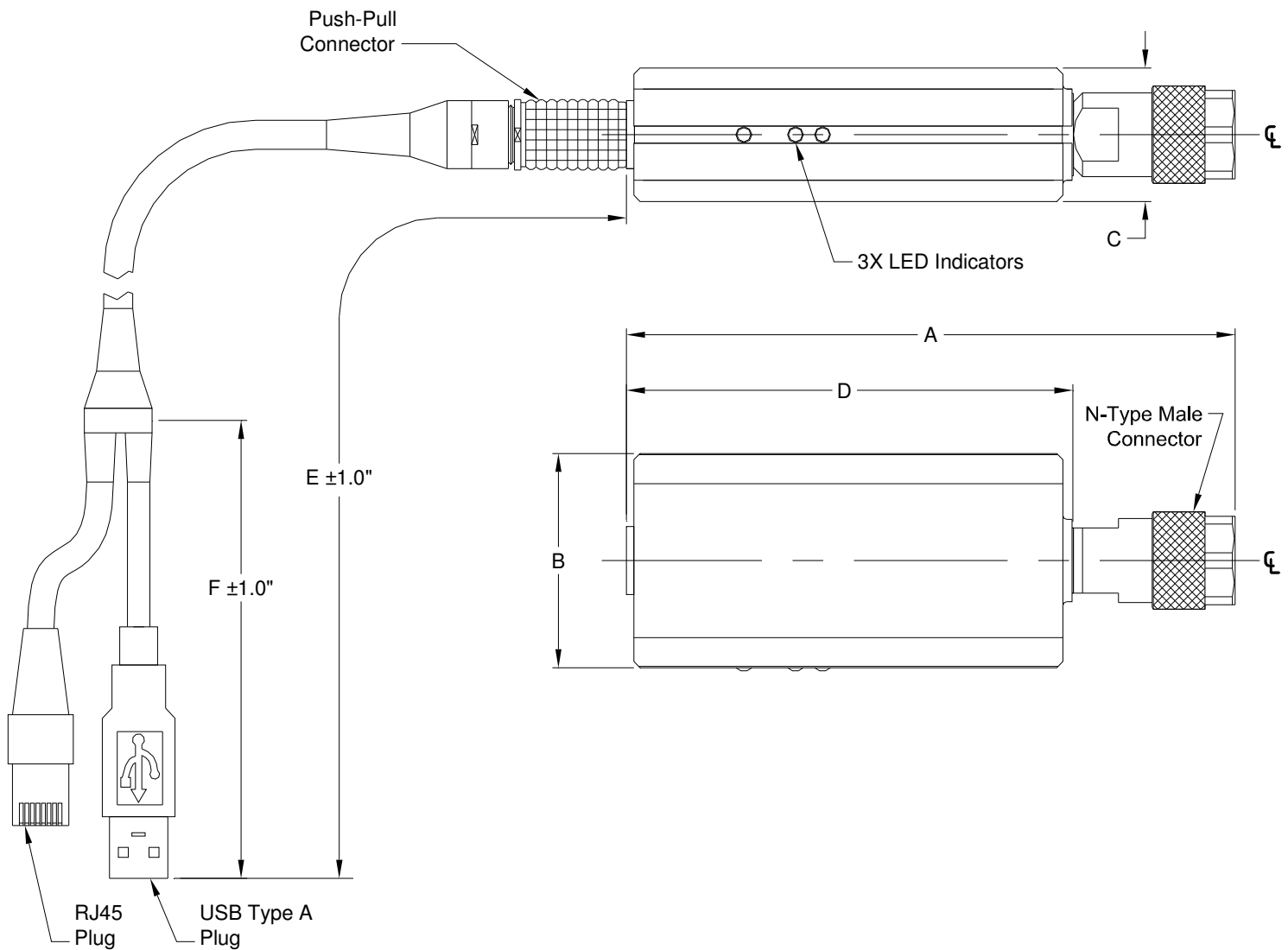

CASE#	A	B	C	D	E	F	WT. GRAMS
JL1941	4.95 (125.7)	1.74 (44.2)	1.08 (27.4)	3.63 (92.2)	80 (2032)	20 (508)	250

Dimensions are in inches (mm). Tolerances: 2 Pl. ± .03; 3 Pl. ± .015

### Notes:

- Case material: Plastic.

**Mini-Circuits®**

INTERNET <http://www.minicircuits.com>

P.O. Box 350166, Brooklyn, New York 11235-0003 (718) 934-4500 Fax (718) 332-4661

Distribution Centers NORTH AMERICA 800-654-7949 • 417-335-5935 • Fax 417-335-5945 • EUROPE 44-1252-832600 • Fax 44-1252-837010

Mini-Circuits ISO 9001 & ISO 14001 Certified



Environmental Specifications **ENV50**

All Mini-Circuits products are manufactured under exacting quality assurance and control standards, and are capable of meeting published specifications after being subjected to any or all of the following physical and environmental test.

Specification	Test/Inspection Condition	Reference/Spec
Operating Temperature	-0° to 50° C Ambient Environment	Individual Model Data Sheet
Storage Temperature	-30° to 70° C Ambient Environment	Individual Model Data Sheet
Operating and Storage Humidity	5% to 85% RH (non-condensing)	Ambient
Bench Handling Test	Bench Top Tip 45° & Drop	MIL-PRF-28800F
Transit Drop Test	Free Fall Drop, 20 cm (7.9 inches)	MIL-PRF-28800F Class 3