



MMIC SURFACE MOUNT

Voltage Variable Attenuator **PVA-453-34+**

50Ω 10 to 45 GHz

THE BIG DEAL

- Ultra-broad band, 10 to 45 GHz
- Wide attenuation range, up to 51 dB typ. at 30 GHz
- Excellent return loss for all attenuation states
- Low insertion loss, 2 dB typ.
- High IIP3 in all attenuation states



Generic photo used for illustration purposes only

CASE STYLE: JV2579

+RoHS Compliant

The +Suffix identifies RoHS Compliance. See our website for methodologies and qualifications

APPLICATIONS

- 5G MIMO and Back Haul Radio Systems
- Satellite Communications
- Test and Measurement Equipment
- Radar, EW, and ECM Defense Systems

PRODUCT OVERVIEW

The PVA-453-34+ is an absorptive voltage variable attenuator MMIC die fabricated using GaAs pHEMT technology packaged in a small 3.5x2.5 mm SMT package. This VVA covers the frequency range of 10 to 45 GHz offering high dynamic range, low distortion, and low insertion loss. It features two independently controlled attenuators using analog control voltages from -4V to 0V. This product is ideal for applications where a DC voltage is utilized to control RF signal levels such as temperature compensation and AGC circuits.

KEY FEATURES

Feature	Advantages
High IIP3, +26 to +43 dBm typ. over attenuation range	Low distortion enabling improved system performance.
Wide attenuation range, • 45 dB typ. at 20 GHz • 51 dB typ. at 30 GHz • 38 dB typ. at 40 GHz	Low insertion loss and high dynamic range simplify the use of analog signal control.



MMIC SURFACE MOUNT

Voltage Variable Attenuator **PVA-453-34+**

50Ω 10 to 45 GHz

ELECTRICAL SPECIFICATIONS AT 25°C, 50Ω, UNLESS NOTED OTHERWISE

Frequency (GHz)	Condition ¹	Min Attenuation (dB) ²		Max Attenuation (dB)		Attenuation Range (dB)		Return Loss (dB)		IIP3 (dBm) Worst Case, Typ
		Typ.	Max.	Min.	Typ.	Min.	Typ.	Min.	Typ.	
10-20	VCTL1 = -4 V to 0 V, VCTL2 = -4 V	2.1	3.5	18.8	23.8	15.3	21.7	7	17	30
20-30		2.2	3.7	22.9	27.6	19.2	25.4	7.5	14	
30-40		3.0	5.9	26.4	31.1	20.5	28.1	6.5	16	
40-45		4.1	6.3	28.8	34.0	22.5	29.9	10	19	
10-20	VCTL1 = 0 V, VCTL2 = -4 V to 0 V	23.8	28.3	32.1	41.6	3.8	17.7	7	14	30
20-30		27.6	31.8	41.8	51.9	10.0	24.3	7.5	13	
30-40		31.2	36.2	38.3	48.0	-	16.8	6.5	15	
40-45		34.0	36.5	34.7	38.0	-	4.0	10	18	
10-20	VCTL1 = -4 V to 0 V, VCTL2 = -4 V to 0 V VCTL1 = VCTL2	2.1	3.5	32.1	41.5	28.6	39.5	8	17	26
20-30		2.2	3.7	41.4	51.9	37.7	49.7	7.5	14	
30-40		3.0	5.9	37.9	48.0	32.0	45.0	6.5	16	
40-45		4.1	6.3	34.6	38.0	28.3	33.9	10	19	

1. VCTL1 and VCTL2: -4V (min. attenuation) to 0V (max. attenuation). Maximum current for VCTL1 or VCTL2: 5 mA (max at VCTL= -4V)

2. Min attenuation state is the insertion loss.

MAXIMUM RATINGS³

Parameter	Ratings
Operating Case Temperature	-40°C to 85°C
Storage Temperature	-65°C to 150°C
Control Voltage (Vctl1/Vctl2)	-5 to +1V
Absolute Max. RF Input Level	+23 dBm
Thermal Resistance at max. attenuation	44.8°C/W

3. Permanent damage may occur if any of these limits are exceeded.



MMIC SURFACE MOUNT

Voltage Variable Attenuator **PVA-453-34+**

50Ω 10 to 45 GHz

APPLICATION CIRCUIT & PAD DESCRIPTION

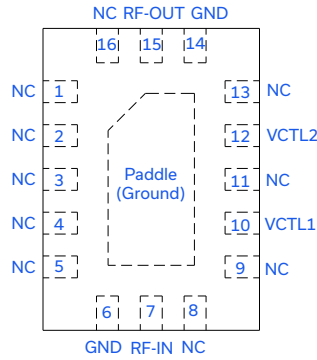
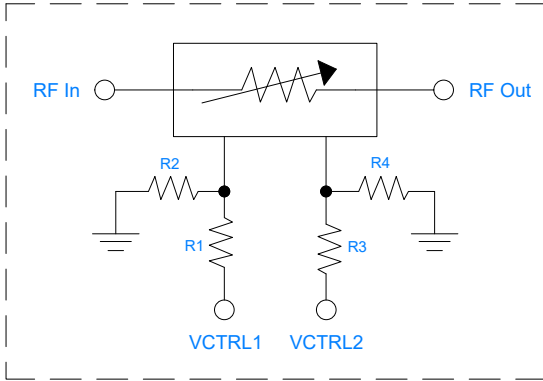

PAD CONNECTIONS

NO CONNECTION	1, 2, 3, 4, 5, 8, 9, 11, 13, 16
RF IN	7
VCTL1	10
VCTL2	12
RF OUT	15
GROUND	6, 14

Components	Size	Value	Qty	Part Number
R1, R3	0201	6.2 kΩ	2	RK73414TTC6201F
R2, R4	0201	2.1 kΩ	2	RK73H1HT2010F

Note: The voltage divider network is required to increase the tuning voltage range of the VVA

PRODUCT MARKING

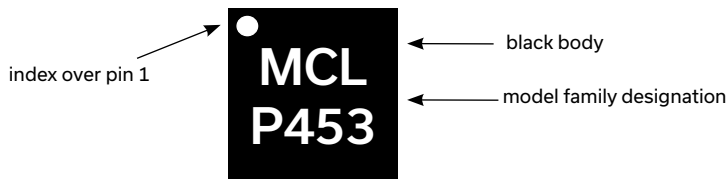

Marking may contain other features or characters for internal lot control





TYPICAL PERFORMANCE CURVES

Attenuation vs. Frequency at Various Control Voltages
VCTRL 1 = -4 V to 0 V, VCTRL 2 = -4 V

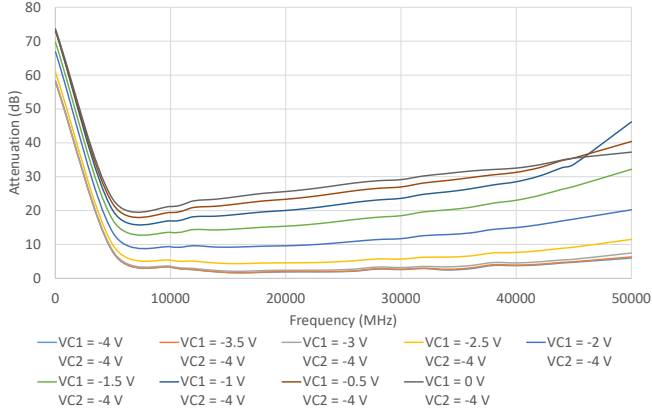

Input Return Loss vs. Frequency at Various Control Voltages
VCTRL 1 = -4 V to 0 V, VCTRL 2 = -4 V

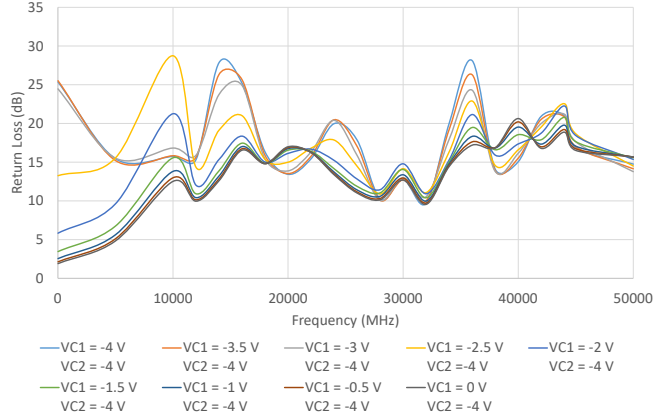

Output Return Loss vs. Frequency at Various Control Voltages
VCTRL 1 = -4 V to 0 V, VCTRL 2 = -4 V

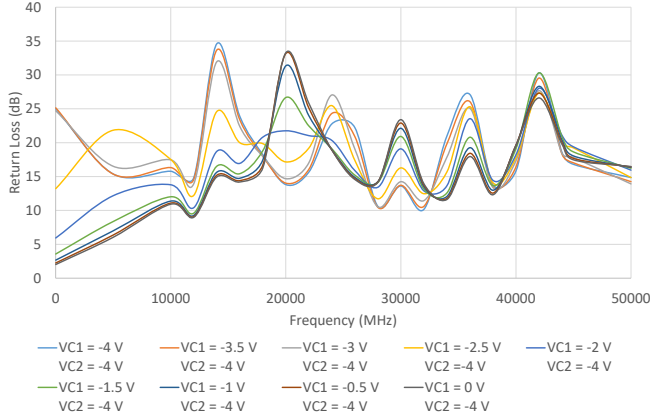

Attenuation vs. Frequency at Various Control Voltages
VCTRL 1 = 0 V, VCTRL 2 = -4 V to 0 V

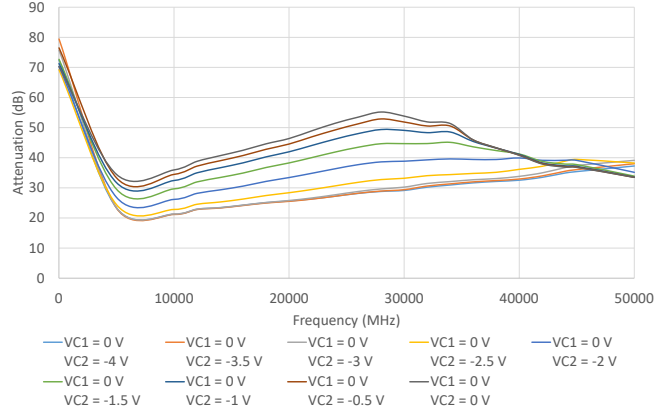

Input Return Loss vs. Frequency at Various Control Voltages
VCTRL 1 = 0 V, VCTRL 2 = -4 V to 0 V

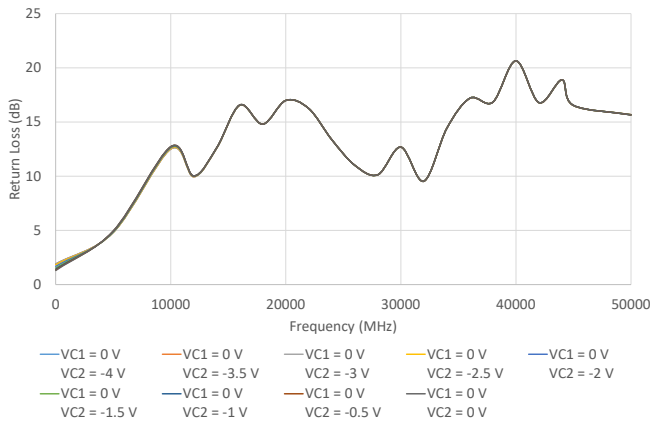

Output Return Loss vs. Frequency at Various Control Voltages
VCTRL 1 = 0 V, VCTRL 2 = -4 V to 0 V

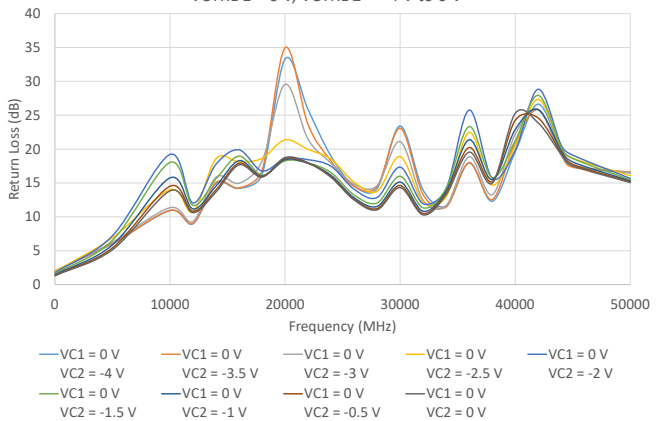



Attenuation vs. Frequency at Various Control Voltages
VCTRL1 = VCTRL2 = -4 V to 0 V

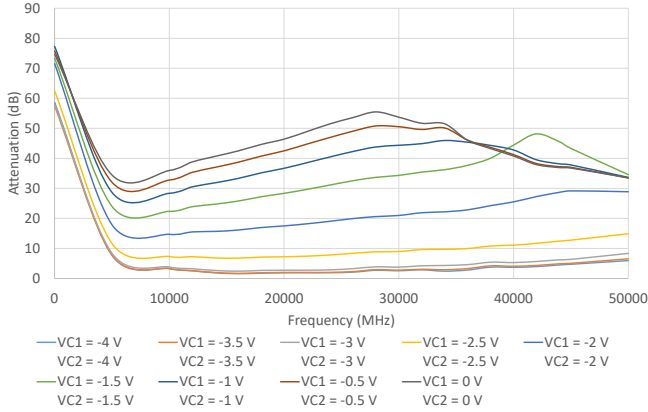

Input Return Loss vs. Frequency at Various Control Voltages
VCTRL1 = VCTRL2 = -4 V to 0 V

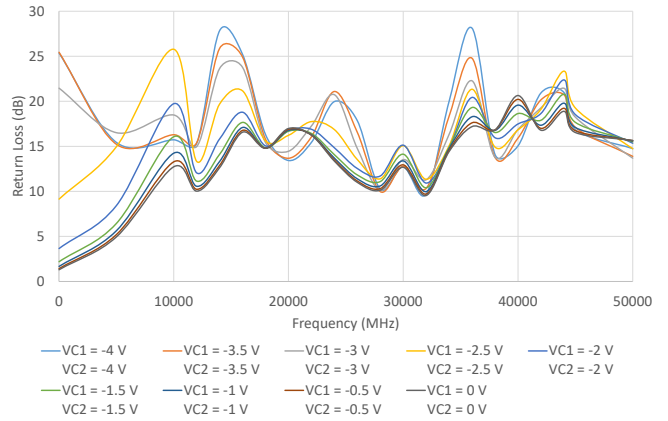

Output Return Loss vs. Frequency at Various Control Voltages
VCTRL1 = VCTRL2 = -4 V to 0 V

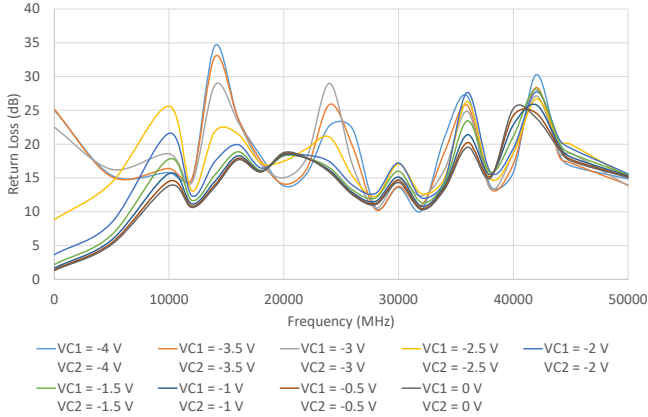

Attenuation vs. Control Voltage at Various Frequencies
(VCTRL1 = VCTRL2)

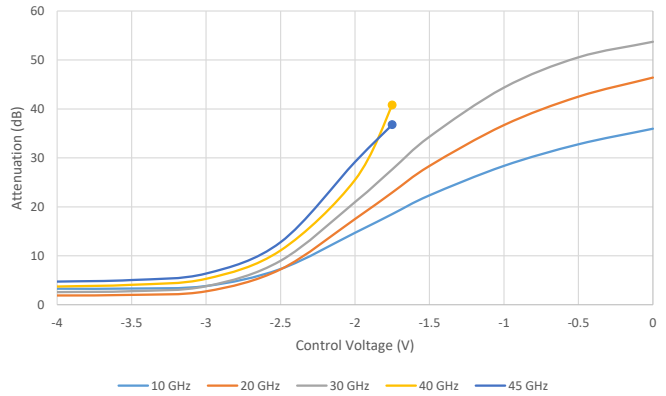

Noise Figure vs. Frequency

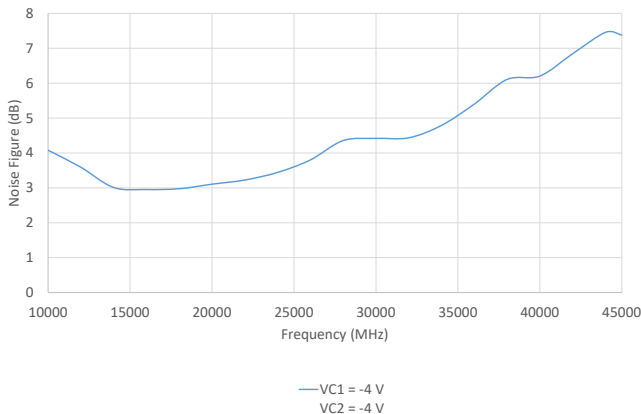



Attenuation vs. Input Power Over Control Voltages at 10 GHz (Fixed VCTRL2)

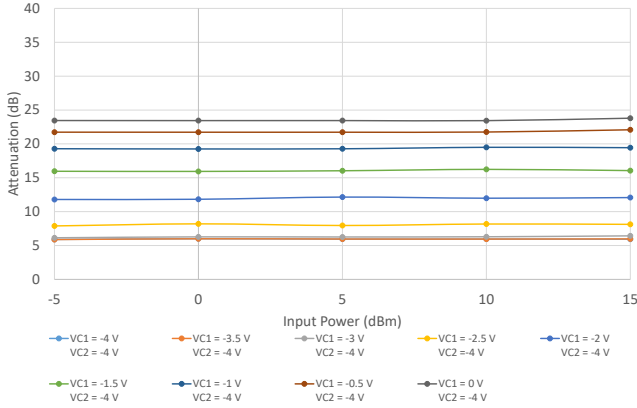

Attenuation vs. Input Power Over Control Voltages at 10 GHz (Fixed VCTRL1)

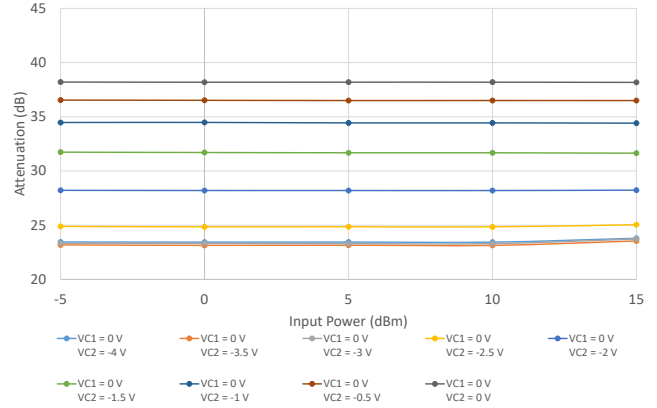

Attenuation vs. Input Power Over Control Voltages at 10 GHz (VCTRL1 = VCTRL2)

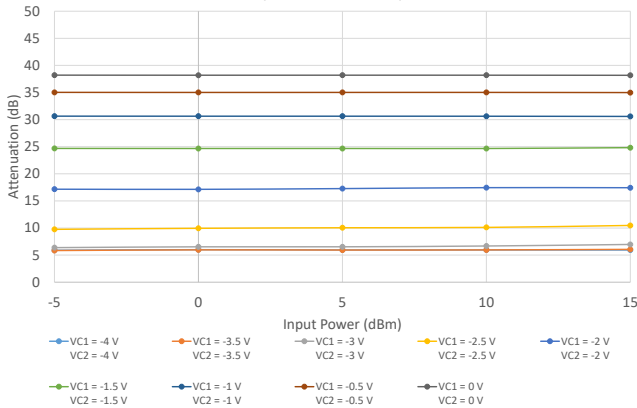

Attenuation vs. Input Power Over Control Voltages at 20 GHz (Fixed VCTRL2)

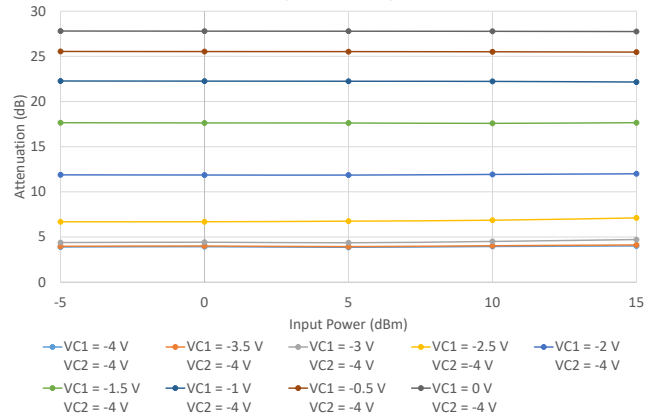

Attenuation vs. Input Power Over Control Voltages at 20 GHz (Fixed VCTRL1)

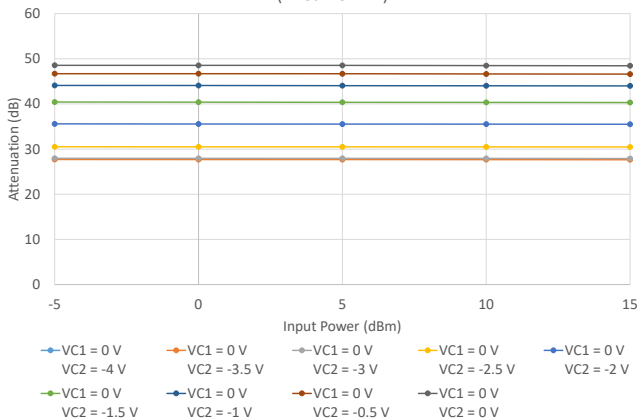

Attenuation vs. Input Power Over Control Voltages at 20 GHz (VCTRL1 = VCTRL2)

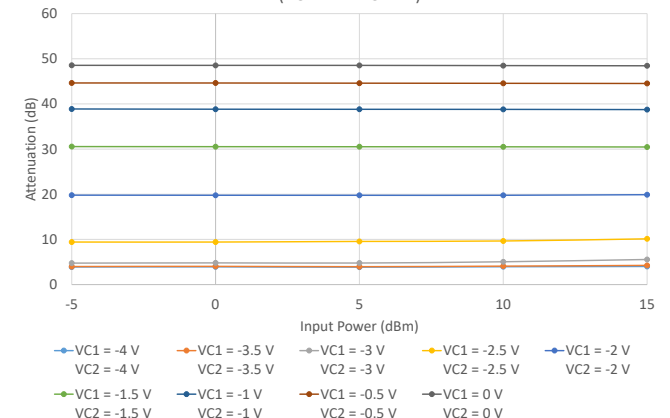

1. Package parasitics limit maximum attenuation range above 30 GHz and may cause attenuator to be non-monotonic with control voltages greater than -1.5V



MMIC SURFACE MOUNT

Voltage Variable Attenuator PVA-453-34+

50Ω 10 to 45 GHz

Attenuation vs. Input Power Over Control Voltages at 44 GHz (Fixed VCTRL2)

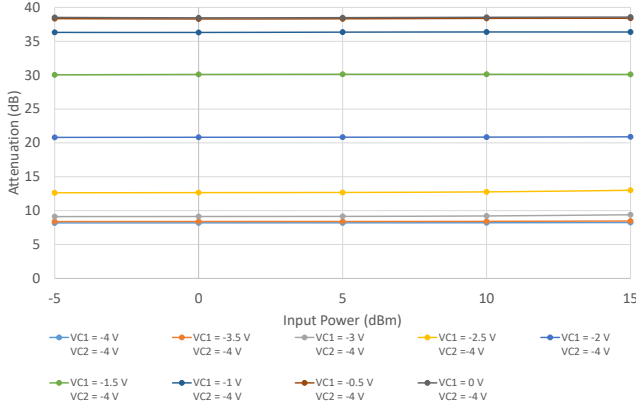

Attenuation vs. Input Power Over Control Voltages at 44 GHz (Fixed VCTRL1)

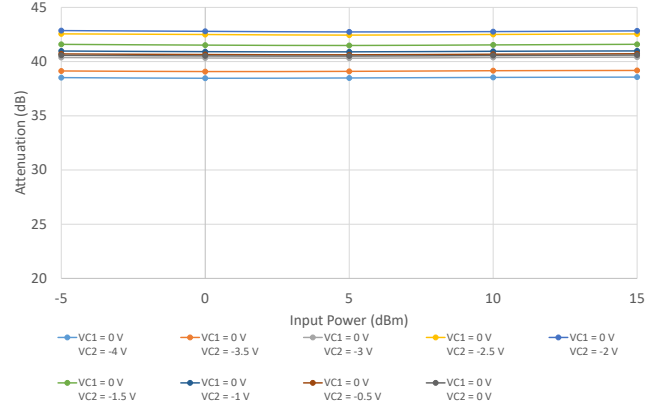

Attenuation vs. Input Power Over Control Voltages at 44 GHz (VCTRL1 = VCTRL2)

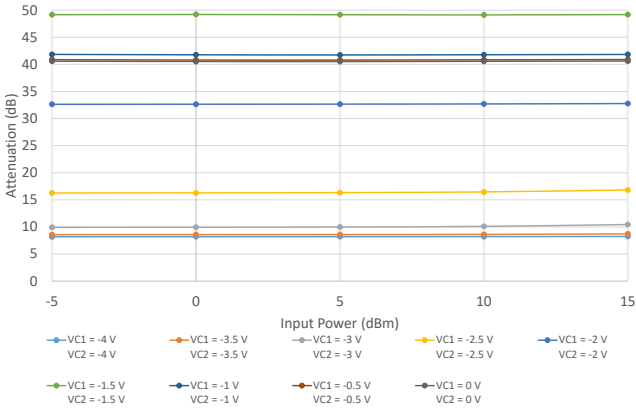

IIP3 vs. Input Power Over Control Voltages at 10 GHz (Fixed VCTRL2)

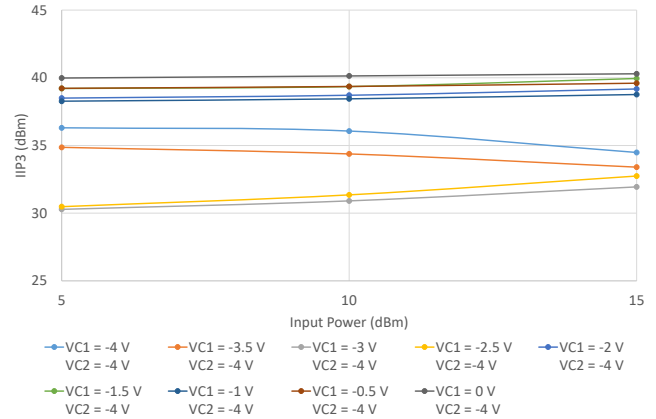

IIP3 vs. Input Power Over Control Voltages at 10 GHz (Fixed VCTRL1)

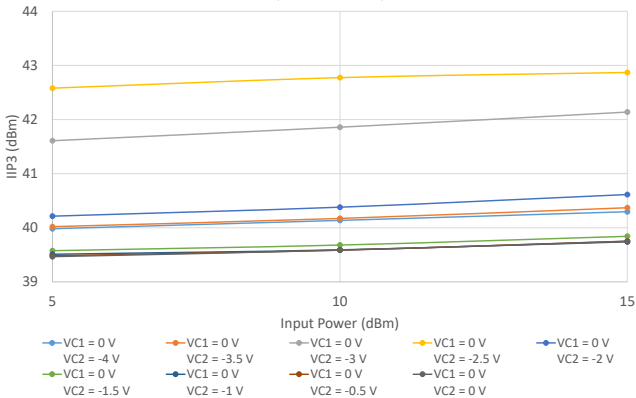

IIP3 vs. Input Power Over Control Voltages at 10 GHz (VCTRL1 = VCTRL2)

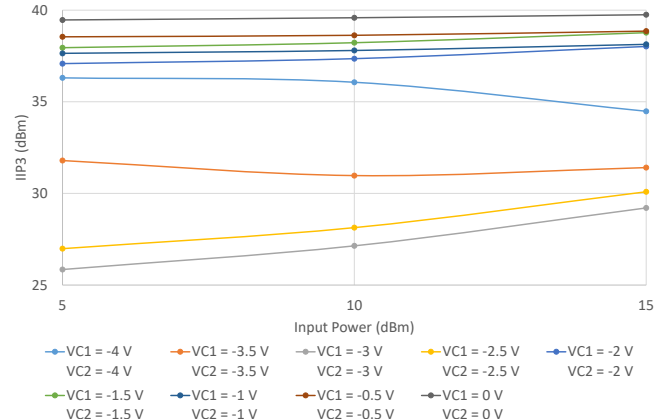



IIP3 vs. Input Power Over Control Voltages at 20 GHz (Fixed VCTRL2)

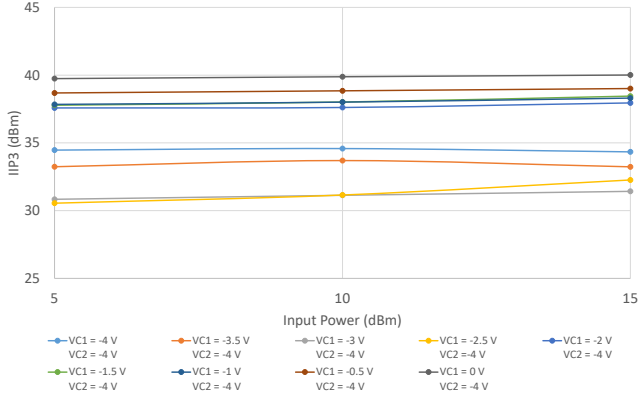

IIP3 vs. Input Power Over Control Voltages at 20 GHz (VCTRL1 = VCTRL2)

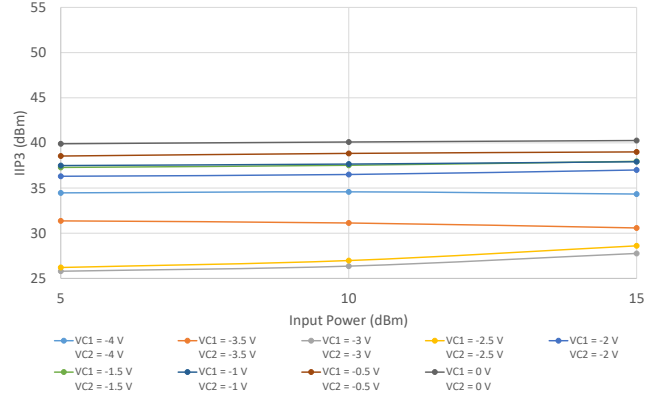

IIP3 vs. Input Power Over Control Voltages at 20 GHz (Fixed VCTRL1)

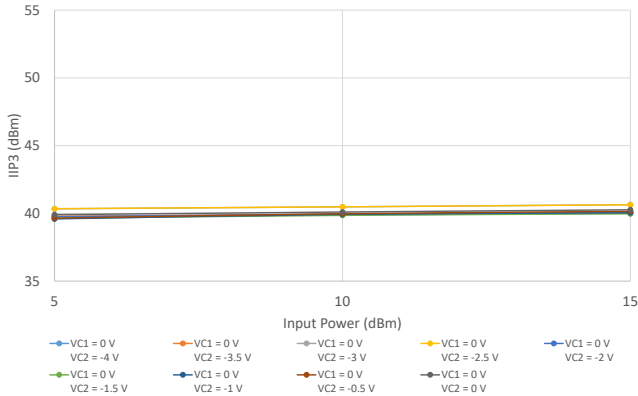

IIP3 vs. Input Power Over Control Voltages at 44 GHz (Fixed VCTRL2)

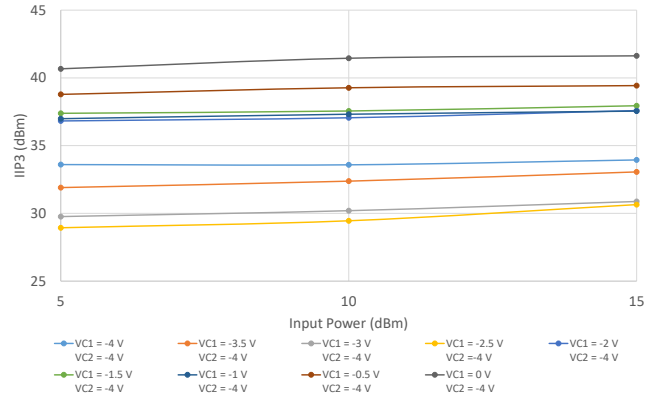

IIP3 vs. Input Power Over Control Voltages at 44 GHz (Fixed VCTRL1)

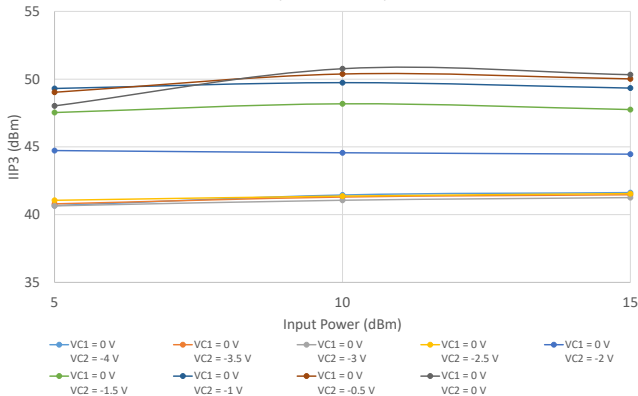

IIP3 vs. Input Power Over Control Voltages at 44 GHz (VCTRL1 = VCTRL2)

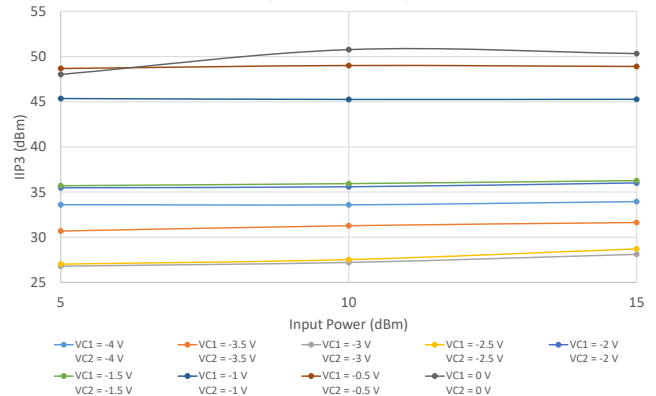



MMIC SURFACE MOUNT

Voltage Variable Attenuator **PVA-453-34+**

50Ω 10 to 45 GHz

ADDITIONAL DETAILED TECHNICAL INFORMATION IS AVAILABLE ON OUR DASH BOARD. TO ACCESS [CLICK HERE](#)

Performance Data	Data Table Swept Graphs S-Parameter (S2P Files) Data Set (.zip file)
Case Style	JV2579 Plastic package, exposed paddle, lead finish: Matte Tin
Tape & Reel	F104
Standard quantities available on reel	7" reels with 20, 50, 100, 200, 500, 1K or 2K devices
Suggested Layout for PCB Design	PL-726
Evaluation Board	TB-PVA-453-34+ (without connectors), TB-PVA-453-34C+ (with connectors)
Environmental Ratings	ENV08T1

ESD RATING

Human Body Model (HBM): Class 1A (250 V to < 500 V) in accordance with ANSI/ESD STM 5.1 - 2001

MSL TEST FLOW CHART

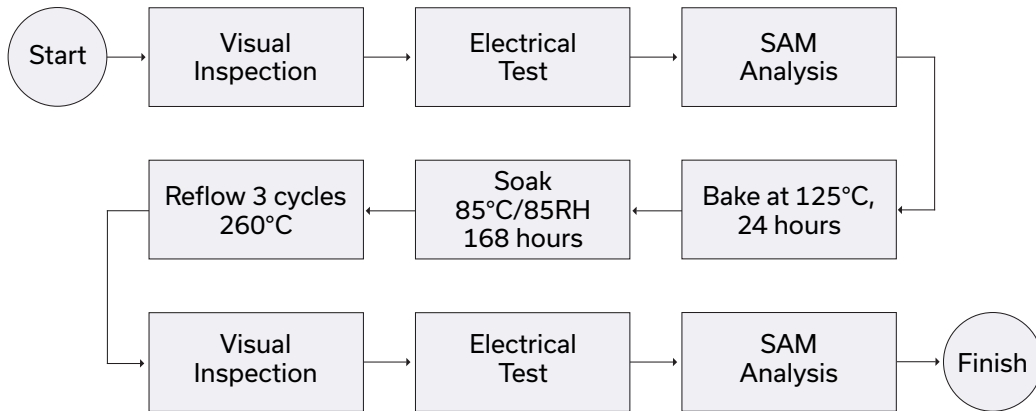

NOTES

- A. Performance and quality attributes and conditions not expressly stated in this specification document are intended to be excluded and do not form a part of this specification document.
- B. Electrical specifications and performance data contained in this specification document are based on Mini-Circuit's applicable established test performance criteria and measurement instructions.
- C. The parts covered by this specification document are subject to Mini-Circuits standard limited warranty and terms and conditions (collectively, "Standard Terms"); Purchasers of this part are entitled to the rights and benefits contained therein. For a full statement of the standard terms and the exclusive rights and remedies thereunder, please visit Mini-Circuits' website at www.minicircuits.com/terms/viewterm.html



Typical Performance Data

Frequency (MHz)	Attenuation relative to control voltage @ Temperature = -40°C					
	(dB)					
	VCTRL1 = -4 V VCTRL2 = -4 V	VCTRL1 = -2 V VCTRL2 = -4 V	VCTRL1 = 0 V VCTRL2 = -4 V	VCTRL1 = -2 V VCTRL2 = -2 V	VCTRL1 = 0 V VCTRL2 = -2 V	VCTRL1 = 0 V VCTRL2 = 0 V
2000	14.74	22.55	34.70	26.90	36.43	41.95
2500	13.00	20.51	32.59	24.85	34.49	40.57
3000	11.61	18.74	30.70	23.06	32.81	39.49
3500	10.45	17.11	28.93	21.40	31.27	38.55
4000	9.43	15.55	27.18	19.82	29.80	37.66
4500	8.53	14.11	25.55	18.33	28.46	36.82
5000	7.71	12.89	24.23	17.07	27.37	36.11
5500	6.95	11.98	23.42	16.15	26.70	35.73
6000	6.26	11.39	23.12	15.64	26.51	35.82
6500	5.66	11.00	23.11	15.38	26.63	36.22
7000	5.14	10.65	23.14	15.20	26.82	36.79
7500	4.66	10.25	23.04	14.98	26.95	37.34
8000	4.21	9.75	22.76	14.65	26.93	37.67
8500	3.85	9.25	22.42	14.25	26.80	37.85
9000	3.61	8.84	22.15	13.88	26.67	37.91
9500	3.46	8.63	22.12	13.66	26.66	37.99
10000	3.31	8.62	22.39	13.65	26.91	38.30
11000	2.88	8.85	23.47	14.06	28.00	39.74
12000	2.52	8.89	24.27	14.40	29.07	41.44
13000	2.10	8.61	24.60	14.47	29.76	42.64
14000	1.84	8.36	24.80	14.41	30.21	43.36
15000	1.62	8.26	25.14	14.46	30.71	44.19
16000	1.55	8.40	25.80	14.80	31.53	45.22
17000	1.59	8.54	26.40	15.23	32.43	46.42
18000	1.74	8.58	26.74	15.53	33.11	47.39
19000	1.94	8.65	27.00	15.80	33.77	48.08
20000	1.84	8.66	27.29	16.03	34.45	49.56
21000	1.75	8.65	27.58	16.20	35.03	50.70
22000	1.83	8.84	27.99	16.59	35.77	51.75
23000	1.89	9.10	28.50	17.06	36.67	53.45
24000	1.87	9.27	28.92	17.40	37.36	54.76
25000	1.89	9.50	29.35	17.79	37.99	55.82
26000	2.05	9.85	29.88	18.29	38.79	57.32
27000	2.46	10.16	30.26	18.65	39.33	58.62
28000	2.79	10.39	30.51	18.94	39.69	59.99
29000	2.56	10.41	30.57	19.03	39.86	58.08
30000	2.42	10.40	30.52	19.06	39.57	55.80
31000	2.81	10.96	31.18	19.70	39.98	54.66
32000	3.00	11.57	31.95	20.34	40.60	54.01
33000	2.50	11.70	32.25	20.42	40.38	52.89
34000	2.39	11.71	32.47	20.43	40.32	51.71
35000	2.64	11.86	32.84	20.60	40.36	50.11
36000	2.87	12.22	33.49	21.09	40.43	46.60
37000	3.17	12.57	33.43	21.52	39.79	44.52
38000	3.65	12.94	33.12	21.99	39.27	42.94
39000	3.80	13.21	33.19	22.43	39.46	41.74
40000	3.53	13.35	33.10	22.87	39.29	40.14
41000	3.55	13.72	33.19	23.60	38.62	38.50
42000	3.83	14.22	33.22	24.39	37.71	37.13
43000	4.23	14.80	34.33	24.99	38.41	37.11
44000	4.30	14.40	34.48	23.20	38.27	36.40
45000	4.62	14.87	35.01	23.64	38.49	36.46
46000	4.68	15.31	35.37	24.05	38.45	36.40
47000	4.72	15.78	36.12	24.33	38.33	36.10
48000	4.71	16.33	35.60	24.72	36.82	34.87
49000	4.91	16.91	35.51	25.08	36.22	34.49
50000	5.32	17.13	36.03	24.72	35.76	33.81

Typical Performance Data

Frequency (MHz)	Attenuation relative to control voltage @ Temperature = 25°C					
	(dB)					
	VCTRL1 = -4 V VCTRL 2 = -4 V	VCTRL1 = -2 V VCTRL 2 = -4 V	VCTRL1 = 0 V VCTRL 2 = -4 V	VCTRL1 = -2 V VCTRL 2 = -2 V	VCTRL1 = 0 V VCTRL 2 = -2 V	VCTRL1 = 0 V VCTRL 2 = 0 V
2000	14.77	23.38	33.80	27.79	35.89	40.82
2500	13.02	21.33	31.71	25.77	33.96	39.31
3000	11.62	19.51	29.79	23.96	32.26	38.11
3500	10.45	17.82	27.96	22.28	30.71	37.02
4000	9.43	16.23	26.19	20.69	29.22	36.04
4500	8.52	14.77	24.57	19.23	27.89	35.12
5000	7.68	13.55	23.27	18.00	26.83	34.36
5500	6.91	12.66	22.45	17.13	26.17	33.93
6000	6.22	12.08	22.12	16.63	25.96	33.96
6500	5.62	11.71	22.07	16.41	26.05	34.29
7000	5.09	11.40	22.08	16.29	26.26	34.82
7500	4.61	11.00	21.93	16.09	26.37	35.29
8000	4.16	10.50	21.62	15.78	26.32	35.54
8500	3.78	9.99	21.24	15.39	26.17	35.60
9000	3.52	9.60	20.97	15.05	26.02	35.64
9500	3.38	9.43	20.96	14.87	26.02	35.69
10000	3.24	9.45	21.25	14.91	26.29	36.04
11000	2.82	9.71	22.21	15.36	27.30	37.36
12000	2.44	9.77	22.92	15.76	28.33	38.94
13000	2.02	9.54	23.19	15.88	29.00	40.07
14000	1.75	9.30	23.33	15.87	29.42	40.79
15000	1.53	9.22	23.63	15.96	29.90	41.51
16000	1.45	9.38	24.22	16.35	30.69	42.62
17000	1.46	9.55	24.79	16.84	31.58	43.72
18000	1.56	9.62	25.11	17.21	32.29	44.65
19000	1.79	9.67	25.32	17.48	32.89	45.47
20000	1.73	9.70	25.59	17.74	33.54	46.65
21000	1.55	9.75	25.89	18.01	34.20	47.75
22000	1.71	9.95	26.28	18.41	34.92	48.86
23000	1.79	10.21	26.76	18.89	35.74	50.22
24000	1.72	10.45	27.23	19.32	36.51	51.50
25000	1.74	10.71	27.65	19.74	37.16	52.47
26000	1.88	11.07	28.16	20.24	37.88	53.62
27000	2.22	11.44	28.64	20.70	38.45	55.00
28000	2.58	11.63	28.82	20.93	38.89	55.05
29000	2.50	11.61	28.84	20.97	38.87	55.06
30000	2.19	11.76	29.00	21.17	38.81	53.90
31000	2.64	12.32	29.66	21.77	39.29	52.54
32000	2.96	12.89	30.39	22.36	39.68	52.03
33000	2.35	13.11	30.80	22.54	39.69	51.53
34000	2.13	13.14	31.01	22.55	39.67	50.79
35000	2.38	13.27	31.33	22.73	39.82	49.41
36000	2.62	13.72	32.01	23.34	39.99	46.12
37000	2.81	14.13	32.10	23.86	39.65	44.42
38000	3.28	14.50	32.00	24.41	39.30	42.60
39000	3.57	14.77	32.17	24.97	39.92	41.80
40000	3.26	15.01	32.48	25.61	39.97	40.31
41000	3.18	15.47	32.87	26.50	39.34	38.67
42000	3.43	16.02	33.05	27.54	38.35	37.27
43000	3.78	16.69	34.39	28.24	39.17	37.22
44000	4.52	16.96	34.93	28.70	39.17	36.93
45000	4.73	17.48	35.49	29.17	39.13	36.77
46000	4.85	18.03	36.19	29.38	38.84	36.48
47000	4.93	18.62	37.12	29.50	38.51	36.10
48000	5.04	19.21	37.53	29.47	37.44	35.32
49000	5.43	19.78	37.27	29.31	36.11	34.23
50000	5.97	20.23	37.25	28.88	35.16	33.49

Typical Performance Data

Frequency (MHz)	Attenuation relative to control voltage @ Temperature = 85°C					
	(dB)					
	VCTRL1 = -4 V VCTRL2 = -4 V	VCTRL1 = -2 V VCTRL2 = -4 V	VCTRL1 = 0 V VCTRL2 = -4 V	VCTRL1 = -2 V VCTRL2 = -2 V	VCTRL1 = 0 V VCTRL2 = -2 V	VCTRL1 = 0 V VCTRL2 = 0 V
2000	14.74	23.85	32.88	28.34	35.25	39.63
2500	13.02	21.79	30.77	26.31	33.35	38.07
3000	11.65	19.97	28.83	24.52	31.64	36.77
3500	10.49	18.25	26.97	22.83	30.05	35.57
4000	9.48	16.64	25.20	21.24	28.57	34.47
4500	8.59	15.18	23.60	19.81	27.25	33.49
5000	7.77	13.98	22.33	18.62	26.22	32.72
5500	7.01	13.10	21.51	17.78	25.57	32.27
6000	6.33	12.54	21.15	17.30	25.32	32.23
6500	5.74	12.18	21.06	17.10	25.38	32.49
7000	5.22	11.86	21.00	16.98	25.54	32.93
7500	4.75	11.46	20.81	16.81	25.63	33.30
8000	4.31	10.97	20.47	16.51	25.56	33.47
8500	3.96	10.47	20.08	16.14	25.38	33.51
9000	3.73	10.11	19.82	15.83	25.24	33.49
9500	3.57	9.97	19.83	15.69	25.26	33.56
10000	3.41	10.02	20.11	15.75	25.52	33.89
11000	2.99	10.31	21.00	16.25	26.50	35.17
12000	2.64	10.37	21.61	16.68	27.47	36.59
13000	2.24	10.14	21.81	16.83	28.09	37.62
14000	2.00	9.93	21.93	16.85	28.49	38.23
15000	1.81	9.91	22.25	17.03	29.01	39.00
16000	1.77	10.10	22.81	17.47	29.81	40.06
17000	1.81	10.26	23.29	17.96	30.64	41.20
18000	1.96	10.31	23.55	18.32	31.31	42.06
19000	2.12	10.38	23.78	18.63	31.92	42.86
20000	2.03	10.44	24.07	18.92	32.56	43.91
21000	2.01	10.56	24.38	19.27	33.25	44.94
22000	2.09	10.79	24.79	19.72	33.96	45.98
23000	2.10	11.06	25.29	20.20	34.78	47.36
24000	2.08	11.30	25.72	20.63	35.50	48.54
25000	2.12	11.57	26.15	21.07	36.15	49.34
26000	2.32	11.96	26.69	21.61	36.89	50.47
27000	2.76	12.35	27.16	22.09	37.56	51.26
28000	3.04	12.52	27.37	22.27	37.86	52.11
29000	2.76	12.52	27.45	22.35	37.92	52.19
30000	2.69	12.75	27.73	22.62	38.02	51.48
31000	3.09	13.34	28.44	23.23	38.50	50.72
32000	3.18	13.88	29.16	23.76	38.95	50.32
33000	2.73	14.07	29.53	23.92	38.96	50.37
34000	2.75	14.10	29.76	23.96	38.95	49.56
35000	3.00	14.30	30.10	24.21	39.25	48.68
36000	3.32	14.88	30.90	24.96	39.58	45.88
37000	3.67	15.27	31.09	25.53	39.62	44.57
38000	4.10	15.65	31.17	26.15	39.46	42.63
39000	4.20	15.97	31.55	26.83	40.31	42.08
40000	3.97	16.29	32.18	27.69	40.73	40.62
41000	4.05	16.78	32.75	28.68	40.41	39.09
42000	4.35	17.38	33.28	29.86	39.15	37.35
43000	4.79	18.11	34.60	30.76	39.93	37.44
44000	5.21	17.74	35.60	29.46	39.92	36.90
45000	5.36	18.23	36.35	29.83	39.99	36.81
46000	5.34	18.68	36.98	30.27	39.83	36.67
47000	5.42	19.21	38.21	30.34	39.29	36.24
48000	5.64	19.96	38.76	30.69	37.46	34.97
49000	6.07	20.55	38.83	30.57	36.51	34.34
50000	6.68	20.87	40.63	29.88	35.85	33.77

Typical Performance Data

Frequency (MHz)	Input Return Loss Relative To Control Voltage @ Temperature = -40°C					
	(dB)					
	VCTRL1 = -4 V VCTRL 2 = -4 V	VCTRL1 = -2 V VCTRL 2 = -4 V	VCTRL1 = 0 V VCTRL 2 = -4 V	VCTRL1 = -2 V VCTRL 2 = -2 V	VCTRL1 = 0 V VCTRL 2 = -2 V	VCTRL1 = 0 V VCTRL 2 = 0 V
2000	19.51	5.66	1.93	3.82	1.82	1.69
2500	17.03	5.67	2.01	3.97	1.92	1.85
3000	15.72	5.92	2.24	4.36	2.17	2.15
3500	15.16	6.45	2.60	5.00	2.56	2.59
4000	15.05	7.35	3.13	5.99	3.11	3.19
4500	15.27	8.67	3.82	7.29	3.82	3.93
5000	15.42	10.31	4.61	8.80	4.64	4.77
5500	16.02	11.85	5.35	10.03	5.39	5.53
6000	17.68	12.42	5.79	10.38	5.83	5.96
6500	20.90	11.95	5.91	10.13	5.95	6.06
7000	25.86	11.21	5.88	9.84	5.92	6.02
7500	31.38	10.80	5.91	9.87	5.94	6.03
8000	31.49	11.07	6.18	10.50	6.22	6.29
8500	22.17	12.10	6.81	11.86	6.85	6.93
9000	16.97	14.16	8.02	14.38	8.07	8.15
9500	14.76	17.70	9.94	18.66	10.01	10.11
10000	14.80	23.53	12.24	22.32	12.36	12.47
11000	18.65	16.10	11.86	14.38	11.92	11.99
12000	15.07	11.75	9.39	11.67	9.39	9.43
13000	18.78	12.28	9.52	12.53	9.52	9.54
14000	28.24	15.51	12.13	16.11	12.14	12.16
15000	31.50	21.03	16.76	22.36	16.83	16.87
16000	23.05	17.82	15.74	18.24	15.70	15.75
17000	21.07	15.71	14.21	15.73	14.20	14.21
18000	15.56	14.96	14.47	14.99	14.52	14.51
19000	12.17	13.94	15.03	14.44	14.93	14.95
20000	13.59	15.27	16.30	15.70	16.03	16.08
21000	16.00	19.96	19.65	20.67	19.72	19.69
22000	15.37	16.98	17.18	17.33	17.28	17.26
23000	15.60	14.45	13.33	14.03	13.15	13.21
24000	18.62	15.43	13.09	14.96	13.12	13.14
25000	22.21	14.47	12.11	13.92	12.15	12.16
26000	17.99	12.08	10.11	11.55	9.98	10.01
27000	11.58	11.04	9.37	11.11	9.38	9.38
28000	9.45	10.67	9.27	11.05	9.28	9.28
29000	11.33	12.55	10.88	12.78	10.77	10.80
30000	13.32	16.75	13.50	17.43	13.67	13.66
31000	10.04	11.60	9.78	11.77	9.70	9.74
32000	8.63	9.31	7.98	9.21	7.85	7.89
33000	12.46	10.56	9.18	10.20	9.20	9.20
34000	18.57	14.21	13.37	13.88	13.53	13.48
35000	21.31	20.88	20.08	19.83	19.53	19.68
36000	32.10	22.79	16.61	21.87	16.89	16.86
37000	16.29	15.46	13.66	15.06	13.62	13.65
38000	11.36	13.32	14.80	13.34	14.69	14.73
39000	10.79	13.60	18.11	14.03	18.16	18.15
40000	13.80	14.39	17.12	14.48	17.17	17.18
41000	18.80	15.12	14.15	14.64	13.94	14.01
42000	21.35	17.29	14.23	16.82	13.99	14.06
43000	22.86	22.96	17.75	23.54	17.99	17.92
44000	22.34	23.51	19.14	22.97	18.79	18.70
45000	17.74	19.94	17.63	20.08	17.47	17.44
46000	12.48	13.61	12.16	13.55	12.14	12.13
47000	11.62	11.37	10.19	11.15	10.12	10.10
48000	14.75	12.36	11.21	12.24	11.37	11.38
49000	14.38	11.72	11.50	11.01	10.85	10.73
50000	12.32	12.84	13.60	12.61	13.26	13.21

Typical Performance Data

Frequency (MHz)	Input Return Loss Relative To Control Voltage @ Temperature = 25°C					
	(dB)					
	VCTRL1 = -4 V VCTRL2 = -4 V	VCTRL1 = -2 V VCTRL2 = -4 V	VCTRL1 = 0 V VCTRL2 = -4 V	VCTRL1 = -2 V VCTRL2 = -2 V	VCTRL1 = 0 V VCTRL2 = -2 V	VCTRL1 = 0 V VCTRL2 = 0 V
2000	19.21	5.25	2.13	3.65	1.98	1.83
2500	16.90	5.29	2.22	3.82	2.11	2.02
3000	15.62	5.59	2.47	4.23	2.38	2.35
3500	14.94	6.16	2.87	4.91	2.81	2.82
4000	14.81	7.02	3.40	5.85	3.37	3.43
4500	15.12	8.19	4.08	7.04	4.07	4.15
5000	15.38	9.62	4.86	8.41	4.87	4.98
5500	16.11	10.97	5.61	9.59	5.64	5.76
6000	18.03	11.60	6.11	10.09	6.15	6.27
6500	21.56	11.33	6.27	9.97	6.32	6.43
7000	26.61	10.71	6.24	9.71	6.30	6.40
7500	31.62	10.42	6.29	9.79	6.36	6.44
8000	36.62	10.77	6.61	10.45	6.68	6.76
8500	23.95	11.92	7.36	11.89	7.44	7.52
9000	17.45	14.04	8.68	14.37	8.77	8.86
9500	14.53	17.38	10.62	18.06	10.72	10.83
10000	14.12	21.32	12.67	20.33	12.80	12.91
11000	18.06	15.34	11.94	14.28	12.02	12.08
12000	14.53	11.74	9.74	11.83	9.78	9.81
13000	18.26	12.28	9.97	12.58	9.99	10.02
14000	26.52	15.43	12.59	15.96	12.61	12.64
15000	29.09	19.64	16.52	20.64	16.56	16.58
16000	22.79	17.58	15.86	18.10	15.88	15.90
17000	21.43	15.31	14.14	15.34	14.13	14.14
18000	16.99	14.37	14.13	14.41	14.12	14.13
19000	11.94	14.56	15.46	15.10	15.47	15.47
20000	12.40	16.74	17.58	17.35	17.59	17.59
21000	17.26	18.82	19.09	19.26	19.10	19.10
22000	14.93	16.93	16.77	17.12	16.78	16.78
23000	14.79	14.90	13.93	14.77	13.93	13.93
24000	20.00	14.32	12.68	13.98	12.67	12.68
25000	21.24	14.20	12.23	13.81	12.23	12.23
26000	17.35	12.68	10.91	12.42	10.91	10.91
27000	11.95	10.92	9.55	10.98	9.55	9.55
28000	9.39	11.00	9.76	11.29	9.76	9.76
29000	10.19	13.80	12.05	14.13	12.04	12.05
30000	14.21	15.48	13.07	15.84	13.08	13.08
31000	9.94	11.80	10.18	12.03	10.19	10.19
32000	7.62	10.03	8.76	10.04	8.76	8.76
33000	11.30	10.97	9.86	10.65	9.85	9.85
34000	19.66	14.61	14.37	14.19	14.35	14.35
35000	20.98	24.55	22.56	23.92	22.56	22.55
36000	30.97	20.37	16.20	19.67	16.20	16.21
37000	18.10	15.11	14.16	14.87	14.15	14.15
38000	11.75	13.66	15.45	13.78	15.44	15.43
39000	10.32	14.05	17.73	14.33	17.72	17.72
40000	12.05	15.27	16.69	15.31	16.71	16.72
41000	16.57	16.44	15.11	16.29	15.11	15.12
42000	20.05	18.36	15.54	18.21	15.53	15.54
43000	23.99	22.42	18.41	22.37	18.39	18.41
44000	20.99	22.26	18.88	22.38	20.56	18.89
45000	16.84	18.45	16.52	18.53	19.12	16.54
46000	13.94	14.47	13.11	14.43	17.36	13.11
47000	13.77	12.51	11.51	12.38	14.89	11.50
48000	15.59	12.55	11.94	12.39	13.81	11.92
49000	15.61	14.05	13.93	13.94	14.54	13.90
50000	14.75	15.36	15.69	15.35	15.66	15.65

Typical Performance Data

Frequency (MHz)	Input Return Loss Relative To Control Voltage @ Temperature = 85°C					
	(dB)					
	VCTRL1 = -4 V VCTRL 2 = -4 V	VCTRL1 = -2 V VCTRL 2 = -4 V	VCTRL1 = 0 V VCTRL 2 = -4 V	VCTRL1 = -2 V VCTRL 2 = -2 V	VCTRL1 = 0 V VCTRL 2 = -2 V	VCTRL1 = 0 V VCTRL 2 = 0 V
2000	19.39	5.06	2.34	3.58	2.15	1.98
2500	16.87	5.12	2.44	3.76	2.28	2.17
3000	15.51	5.44	2.71	4.20	2.58	2.53
3500	14.94	6.06	3.16	4.91	3.06	3.06
4000	14.82	6.98	3.77	5.90	3.70	3.75
4500	15.07	8.19	4.52	7.12	4.48	4.56
5000	15.28	9.60	5.35	8.48	5.33	5.44
5500	15.93	10.89	6.13	9.62	6.13	6.25
6000	17.63	11.44	6.60	10.10	6.62	6.74
6500	20.85	11.14	6.71	9.96	6.76	6.86
7000	25.91	10.53	6.62	9.70	6.69	6.79
7500	32.15	10.27	6.65	9.79	6.73	6.82
8000	29.65	10.70	7.04	10.51	7.11	7.20
8500	21.10	11.97	7.91	12.05	7.99	8.09
9000	16.52	14.26	9.43	14.66	9.51	9.62
9500	14.74	17.77	11.56	18.31	11.64	11.78
10000	15.12	21.05	13.54	19.91	13.62	13.77
11000	18.68	14.94	12.18	14.18	12.30	12.36
12000	15.17	11.69	9.97	11.84	10.07	10.10
13000	19.11	12.25	10.29	12.56	10.31	10.34
14000	27.21	15.56	13.13	16.15	13.15	13.17
15000	34.85	19.75	17.12	20.53	17.07	17.12
16000	22.78	17.33	15.82	17.82	15.97	15.98
17000	20.65	15.16	14.17	15.24	14.22	14.21
18000	15.05	14.32	14.25	14.39	14.13	14.12
19000	12.40	14.75	15.42	15.30	15.52	15.50
20000	14.22	17.08	17.35	17.88	17.95	17.89
21000	16.02	18.91	19.30	19.22	19.10	19.10
22000	15.50	16.87	16.88	16.86	16.58	16.60
23000	16.45	14.97	13.86	14.91	14.17	14.17
24000	19.32	14.36	12.98	14.06	12.94	12.95
25000	21.92	14.26	12.69	13.98	12.59	12.59
26000	17.59	12.60	10.98	12.55	11.23	11.21
27000	11.15	10.80	9.70	10.87	9.67	9.67
28000	9.39	11.15	10.16	11.36	10.07	10.08
29000	12.20	14.71	12.94	15.06	13.13	13.13
30000	13.77	15.80	13.86	15.97	13.58	13.60
31000	10.11	11.67	10.26	11.92	10.37	10.36
32000	9.09	10.04	8.83	10.12	9.06	9.05
33000	13.35	11.08	10.27	10.78	10.20	10.20
34000	17.09	15.23	15.87	14.75	15.31	15.31
35000	21.89	29.56	23.98	29.89	25.30	25.32
36000	28.41	19.20	16.39	18.39	15.83	15.88
37000	15.15	14.94	14.49	14.68	14.38	14.38
38000	11.49	14.10	15.82	14.27	16.00	15.98
39000	11.52	14.57	17.53	14.79	17.52	17.50
40000	14.92	15.55	16.44	15.62	16.30	16.29
41000	19.39	16.63	15.08	16.87	15.44	15.39
42000	21.42	18.67	15.83	18.97	16.43	16.38
43000	22.23	22.29	19.44	21.87	18.80	18.84
44000	21.67	23.32	20.09	23.49	20.28	20.26
45000	16.77	18.24	16.54	18.53	16.86	16.90
46000	14.30	14.23	13.12	14.26	13.16	13.19
47000	13.66	12.43	11.60	12.36	11.63	11.64
48000	14.55	12.20	11.80	12.01	11.64	11.64
49000	14.83	13.51	13.15	13.58	13.57	13.58
50000	14.09	14.78	14.93	14.96	15.24	15.23

Typical Performance Data

Frequency (MHz)	Output Return Loss Relative To Control Voltage @ Temperature = -40°C					
	(dB)					
	VCTRL1 = -4 V VCTRL2 = -4 V	VCTRL1 = -2 V VCTRL2 = -4 V	VCTRL1 = 0 V VCTRL2 = -4 V	VCTRL1 = -2 V VCTRL2 = -2 V	VCTRL1 = 0 V VCTRL2 = -2 V	VCTRL1 = 0 V VCTRL2 = 0 V
2000	20.14	5.89	2.04	3.83	2.10	1.74
2500	17.57	6.04	2.18	3.95	2.34	1.93
3000	16.07	6.49	2.50	4.27	2.77	2.21
3500	15.34	7.37	3.04	4.85	3.44	2.63
4000	15.06	8.79	3.81	5.75	4.38	3.21
4500	15.16	10.71	4.72	6.97	5.59	3.93
5000	15.26	12.83	5.67	8.56	7.05	4.82
5500	15.93	13.32	6.17	10.09	8.29	5.78
6000	17.62	11.91	6.08	10.59	8.68	6.38
6500	20.82	10.53	5.81	10.08	8.45	6.44
7000	25.26	9.95	5.82	9.51	8.27	6.23
7500	30.28	10.23	6.24	9.40	8.50	6.11
8000	37.69	11.58	7.25	9.95	9.35	6.27
8500	22.92	14.35	8.97	11.44	11.14	6.93
9000	17.08	18.11	11.13	14.20	14.26	8.23
9500	14.59	17.64	12.13	19.34	19.35	10.44
10000	14.39	14.12	10.87	24.84	20.33	13.51
11000	17.12	10.17	8.23	14.03	12.76	12.95
12000	14.43	9.88	8.32	11.47	11.15	9.67
13000	18.66	13.52	11.13	13.22	13.28	10.13
14000	36.98	20.07	15.42	18.28	18.87	13.43
15000	31.95	19.12	15.78	23.88	24.21	17.87
16000	22.73	16.40	13.86	19.96	19.83	17.35
17000	24.99	17.14	13.44	17.16	17.22	15.39
18000	17.57	18.95	14.62	15.65	15.97	14.86
19000	12.37	18.06	18.27	15.11	15.51	15.40
20000	12.98	18.85	27.11	16.35	16.52	16.92
21000	15.70	22.30	30.27	19.35	19.33	19.24
22000	16.43	22.37	29.36	19.47	19.53	19.16
23000	16.90	20.66	22.76	17.59	17.62	16.74
24000	20.59	20.48	19.92	17.07	17.18	15.67
25000	27.55	17.81	16.73	15.13	15.30	13.81
26000	19.42	14.12	13.11	12.36	12.60	11.08
27000	11.87	12.13	11.81	11.14	11.41	9.69
28000	9.56	11.83	12.51	11.38	11.59	9.66
29000	11.67	14.24	16.14	13.84	13.89	11.47
30000	14.50	21.01	27.60	18.93	19.07	14.72
31000	10.45	14.13	17.45	12.72	12.92	10.63
32000	8.84	10.52	11.85	9.74	9.68	8.12
33000	12.98	10.55	9.86	10.19	9.91	8.65
34000	17.78	12.71	10.54	13.46	13.02	11.98
35000	17.81	16.65	13.24	19.08	18.59	17.38
36000	29.23	23.91	17.33	26.72	25.06	18.92
37000	22.76	18.70	14.48	18.70	17.91	14.53
38000	13.39	13.90	11.24	14.79	14.52	12.96
39000	11.54	13.05	11.43	14.62	14.74	15.08
40000	15.10	15.84	15.61	17.38	17.87	22.70
41000	24.51	21.08	25.81	21.39	22.07	29.65
42000	28.28	24.69	34.68	23.30	23.77	23.98
43000	24.59	27.14	23.47	25.40	24.87	21.13
44000	19.94	22.48	21.03	21.99	21.78	20.19
45000	15.30	18.83	17.16	18.39	18.16	16.57
46000	15.55	18.89	16.12	18.95	18.32	16.28
47000	15.15	17.06	14.47	17.16	16.55	15.03
48000	16.28	13.53	12.06	12.96	12.84	11.61
49000	16.52	12.75	12.35	12.13	12.27	11.23
50000	14.17	15.40	16.17	15.34	15.53	14.84

Typical Performance Data

Frequency (MHz)	Output Return Loss Relative To Control Voltage @ Temperature = 25°C					
	(dB)					
	VCTRL1 = -4 V VCTRL 2 = -4 V	VCTRL1 = -2 V VCTRL 2 = -4 V	VCTRL1 = 0 V VCTRL 2 = -4 V	VCTRL1 = -2 V VCTRL 2 = -2 V	VCTRL1 = 0 V VCTRL 2 = -2 V	VCTRL1 = 0 V VCTRL 2 = 0 V
2000	19.90	5.52	2.29	3.68	2.29	1.91
2500	17.48	5.69	2.45	3.82	2.55	2.10
3000	16.00	6.19	2.81	4.18	3.00	2.42
3500	15.26	7.11	3.40	4.80	3.71	2.89
4000	14.99	8.53	4.23	5.73	4.69	3.53
4500	15.10	10.32	5.18	6.95	5.91	4.30
5000	15.26	12.14	6.13	8.47	7.38	5.24
5500	16.00	12.48	6.60	9.91	8.64	6.22
6000	17.81	11.31	6.48	10.46	9.09	6.85
6500	21.00	10.11	6.19	10.03	8.85	6.90
7000	25.14	9.62	6.17	9.49	8.62	6.66
7500	29.33	9.98	6.63	9.39	8.80	6.52
8000	36.65	11.42	7.73	10.00	9.65	6.74
8500	24.24	14.23	9.60	11.56	11.48	7.50
9000	17.65	17.42	11.72	14.50	14.76	9.02
9500	14.62	16.34	12.23	19.75	19.91	11.51
10000	14.07	13.25	10.73	23.24	20.24	14.65
11000	16.57	10.05	8.44	14.00	13.13	12.96
12000	13.98	10.07	8.72	11.81	11.61	10.15
13000	18.47	13.47	11.44	13.31	13.39	10.64
14000	35.25	19.45	15.61	17.92	18.41	13.86
15000	31.30	18.56	15.83	23.43	23.73	18.42
16000	22.27	16.27	14.00	19.46	19.46	17.32
17000	25.11	17.08	13.81	16.81	16.91	15.38
18000	18.41	19.15	15.39	15.71	15.96	15.07
19000	12.11	19.21	19.66	15.77	16.03	15.97
20000	12.32	19.93	27.56	16.86	16.95	17.32
21000	16.52	21.54	28.69	18.59	18.60	18.68
22000	15.75	22.28	26.41	19.25	19.28	18.88
23000	15.86	21.01	22.65	18.07	18.10	17.36
24000	20.61	19.52	19.19	16.74	16.81	15.70
25000	24.70	17.24	16.29	14.97	15.11	13.85
26000	20.04	14.34	13.46	12.71	12.88	11.57
27000	12.17	12.33	12.09	11.31	11.48	10.04
28000	9.49	12.37	13.07	11.78	11.90	10.23
29000	10.55	15.71	17.60	14.97	14.98	12.67
30000	14.81	20.65	25.81	18.06	18.20	14.81
31000	10.19	14.57	17.32	13.03	13.10	11.11
32000	7.86	11.20	12.14	10.41	10.33	8.91
33000	11.90	10.76	10.10	10.55	10.37	9.26
34000	19.87	12.50	10.72	13.48	13.23	12.54
35000	18.37	17.89	14.72	21.67	21.32	20.85
36000	24.99	25.84	19.36	25.38	24.50	18.91
37000	28.80	17.22	14.15	17.52	17.11	14.63
38000	14.09	14.23	12.01	15.63	15.45	14.40
39000	10.40	14.56	13.20	16.53	16.63	17.46
40000	12.98	17.63	17.84	19.21	19.60	24.89
41000	22.78	22.34	28.50	22.30	22.85	29.37
42000	27.59	25.88	33.05	24.12	24.34	24.50
43000	28.09	25.07	24.06	23.51	23.42	21.74
44000	18.56	21.09	19.78	20.24	18.88	19.21
45000	16.80	19.39	17.47	18.65	16.53	17.53
46000	16.02	17.60	15.71	16.92	13.11	15.92
47000	16.29	15.19	13.70	14.54	11.50	13.73
48000	18.77	14.17	13.24	13.50	11.93	12.84
49000	16.81	14.86	14.69	14.27	13.91	13.73
50000	14.86	15.95	16.48	15.47	15.67	15.05

Typical Performance Data

Frequency (MHz)	Output Return Loss Relative To Control Voltage @ Temperature = 85°C					
	(dB)					
	VCTRL1 = -4 V VCTRL 2 = -4 V	VCTRL1 = -2 V VCTRL 2 = -4 V	VCTRL1 = 0 V VCTRL 2 = -4 V	VCTRL1 = -2 V VCTRL 2 = -2 V	VCTRL1 = 0 V VCTRL 2 = -2 V	VCTRL1 = 0 V VCTRL 2 = 0 V
2000	20.04	5.33	2.53	3.59	2.44	2.04
2500	17.39	5.52	2.70	3.75	2.70	2.24
3000	15.88	6.05	3.09	4.12	3.16	2.58
3500	15.16	7.01	3.74	4.78	3.90	3.09
4000	14.88	8.45	4.64	5.74	4.91	3.78
4500	14.98	10.21	5.66	6.98	6.17	4.63
5000	15.14	11.91	6.63	8.50	7.65	5.63
5500	15.88	12.14	7.06	9.91	8.93	6.65
6000	17.62	11.01	6.85	10.43	9.37	7.27
6500	20.97	9.90	6.51	10.00	9.09	7.27
7000	25.96	9.53	6.52	9.51	8.86	7.01
7500	33.17	10.00	7.04	9.47	9.04	6.90
8000	33.84	11.55	8.25	10.15	9.93	7.19
8500	21.79	14.36	10.21	11.79	11.81	8.07
9000	16.80	16.99	12.20	14.83	15.14	9.77
9500	14.75	15.60	12.31	20.01	20.21	12.45
10000	14.85	12.80	10.73	22.45	20.24	15.55
11000	17.33	9.99	8.61	14.03	13.37	13.14
12000	14.65	10.19	8.99	11.94	11.81	10.47
13000	19.19	13.67	11.85	13.45	13.54	11.09
14000	38.54	19.03	15.78	18.18	18.54	14.52
15000	34.92	18.01	15.66	22.40	22.58	18.48
16000	22.91	16.49	14.38	19.07	19.12	17.20
17000	25.91	17.54	14.47	16.88	16.97	15.65
18000	17.03	19.58	16.25	15.93	16.12	15.41
19000	12.60	19.81	20.63	16.13	16.30	16.28
20000	13.56	20.50	26.99	17.28	17.29	17.62
21000	15.59	21.16	26.97	18.28	18.28	18.46
22000	16.36	20.92	23.81	18.33	18.38	18.09
23000	18.09	20.30	20.83	17.83	17.86	17.11
24000	22.78	19.61	18.84	17.19	17.22	16.13
25000	30.08	17.59	16.67	15.44	15.54	14.44
26000	18.39	14.11	13.35	12.60	12.73	11.67
27000	11.17	11.99	11.86	10.99	11.12	9.93
28000	9.45	12.45	13.21	11.78	11.86	10.43
29000	12.43	16.54	18.34	15.64	15.63	13.51
30000	14.96	21.65	27.13	18.43	18.52	15.48
31000	10.36	14.37	16.54	12.80	12.84	11.17
32000	9.29	11.02	11.52	10.31	10.25	9.03
33000	14.30	10.75	10.01	10.71	10.57	9.66
34000	16.68	13.12	11.57	14.36	14.16	13.72
35000	18.84	19.88	16.58	25.15	24.69	23.77
36000	33.28	24.49	19.37	23.80	23.28	18.94
37000	20.61	17.24	14.74	17.68	17.38	15.34
38000	13.23	14.75	12.83	16.35	16.23	15.51
39000	12.63	15.79	14.62	18.11	18.18	19.47
40000	17.89	20.00	20.92	21.83	22.16	29.02
41000	27.09	24.53	31.09	24.66	25.14	33.17
42000	26.03	24.84	33.20	23.73	24.04	26.12
43000	21.74	22.75	22.66	21.41	21.42	20.76
44000	16.54	19.00	18.06	18.73	18.54	17.47
45000	16.39	18.69	16.62	19.01	18.68	17.15
46000	18.82	20.00	17.91	19.90	19.58	17.95
47000	18.31	17.47	16.05	17.17	16.95	15.74
48000	18.50	14.11	13.08	13.97	13.85	13.00
49000	15.32	13.65	13.25	13.54	13.50	12.88
50000	13.54	15.21	15.86	14.93	14.96	14.59

Voltage Variable Attenuator **PVA-453-34+**

Typical Performance Data

Frequency (MHz)	Noise Figure Vs. temperature (dB)		
	-40°C	+25°C	+85°C
	VCTRL1 = -4 V VCTRL 2 = -4 V	VCTRL1 = -4 V VCTRL 2 = -4 V	VCTRL1 = -4 V VCTRL 2 = -4 V
10000	3.50	4.14	4.82
11000	3.27	4.05	4.38
12000	2.76	3.57	4.15
13000	2.59	3.56	3.78
14000	2.26	2.90	3.53
15000	2.13	3.00	3.37
16000	2.06	2.82	3.52
17000	2.46	3.11	3.65
18000	2.23	3.13	3.98
19000	2.49	3.55	4.01
20000	2.29	2.97	3.45
21000	2.46	3.32	3.84
22000	2.46	3.46	4.08
23000	2.42	3.45	3.99
24000	2.25	3.19	4.12
25000	2.75	3.39	4.09
26000	2.83	3.89	4.55
27000	2.93	4.17	4.66
28000	3.50	4.48	4.65
29000	3.26	4.23	5.03
30000	3.17	4.41	4.94
31000	3.04	4.35	4.91
32000	3.32	4.65	5.12
33000	3.52	4.34	5.22
34000	3.51	4.73	5.38
35000	3.53	4.89	5.55
36000	3.79	5.47	5.98
37000	4.22	5.52	6.40
38000	4.79	5.73	6.83
39000	5.51	6.75	7.29
40000	4.86	6.37	6.90
41000	5.82	6.07	7.06
42000	5.32	6.86	7.65
43000	6.60	7.57	8.28
43500	6.43	7.26	8.21
44000	6.15	7.74	8.89
45000	6.26	6.60	7.88

Typical Performance Data

Attenuation vs. input power at 10 GHz @ 25°C						
Input Power	(dB)					
(dBm)	VCTRL1 = -4 V VCTRL 2 = -4 V	VCTRL1 = -2 V VCTRL 2 = -4 V	VCTRL1 = 0 V VCTRL 2 = -4 V	VCTRL1 = -2 V VCTRL 2 = -2 V	VCTRL1 = 0 V VCTRL 2 = -2 V	VCTRL1 = 0 V VCTRL 2 = 0 V
-5	6.00	11.81	23.52	17.29	28.36	38.41
0	6.12	11.87	23.52	17.28	28.35	38.41
5	6.01	12.24	23.53	17.44	28.35	38.41
10	6.07	12.02	23.52	17.66	28.35	38.41
15	6.05	12.21	23.76	17.49	28.34	38.39

Attenuation vs. input power at 20 GHz @ 25°C						
Input Power	(dB)					
(dBm)	VCTRL1 = -4 V VCTRL 2 = -4 V	VCTRL1 = -2 V VCTRL 2 = -4 V	VCTRL1 = 0 V VCTRL 2 = -4 V	VCTRL1 = -2 V VCTRL 2 = -2 V	VCTRL1 = 0 V VCTRL 2 = -2 V	VCTRL1 = 0 V VCTRL 2 = 0 V
-5	3.88	11.89	27.86	19.90	35.76	48.75
0	3.92	11.87	27.84	19.88	35.70	48.75
5	3.84	11.88	27.83	19.88	35.69	48.74
10	3.94	12.06	27.82	19.89	35.68	48.70
15	3.99	12.04	27.80	19.98	35.66	48.66

Attenuation vs. input power at 44 GHz @ 25°C						
Input Power	(dB)					
(dBm)	VCTRL1 = -4 V VCTRL 2 = -4 V	VCTRL1 = -2 V VCTRL 2 = -4 V	VCTRL1 = 0 V VCTRL 2 = -4 V	VCTRL1 = -2 V VCTRL 2 = -2 V	VCTRL1 = 0 V VCTRL 2 = -2 V	VCTRL1 = 0 V VCTRL 2 = 0 V
-5	8.67	21.39	38.72	33.08	42.88	40.78
0	8.67	21.40	38.66	33.12	42.78	40.73
5	8.68	21.41	38.68	33.17	42.74	40.71
10	8.69	21.43	38.75	33.22	42.78	40.78
15	8.72	21.46	38.77	33.27	42.82	40.81

Typical Performance Data

Attenuation vs. input power at 20 GHz @ temperature -40°C						
Input Power	(dBm)					
(dBm)	VCTRL1 = -4 V VCTRL 2 = -4 V	VCTRL1 = -2 V VCTRL 2 = -4 V	VCTRL1 = 0 V VCTRL 2 = -4 V	VCTRL1 = -2 V VCTRL 2 = -2 V	VCTRL1 = 0 V VCTRL 2 = -2 V	VCTRL1 = 0 V VCTRL 2 = 0 V
-5	3.07	10.21	28.68	17.61	35.86	50.60
0	3.22	10.22	28.67	17.60	35.82	50.57
5	3.14	10.27	28.67	17.61	35.81	50.58
10	3.20	10.25	28.65	17.71	35.80	50.56
15	3.06	10.42	28.61	17.77	35.77	50.50

Attenuation vs. input power at 20 GHz @ temperature 25°C						
Input Power	(dBm)					
(dBm)	VCTRL1 = -4 V VCTRL 2 = -4 V	VCTRL1 = -2 V VCTRL 2 = -4 V	VCTRL1 = 0 V VCTRL 2 = -4 V	VCTRL1 = -2 V VCTRL 2 = -2 V	VCTRL1 = 0 V VCTRL 2 = -2 V	VCTRL1 = 0 V VCTRL 2 = 0 V
-5	3.88	11.89	27.86	19.90	35.76	48.75
0	3.92	11.87	27.84	19.88	35.70	48.75
5	3.84	11.88	27.83	19.88	35.69	48.74
10	3.94	12.06	27.82	19.89	35.68	48.70
15	3.99	12.04	27.80	19.98	35.66	48.66

Attenuation vs. input power at 20 GHz @ temperature 85°C						
Input Power	(dBm)					
(dBm)	VCTRL1 = -4 V VCTRL 2 = -4 V	VCTRL1 = -2 V VCTRL 2 = -4 V	VCTRL1 = 0 V VCTRL 2 = -4 V	VCTRL1 = -2 V VCTRL 2 = -2 V	VCTRL1 = 0 V VCTRL 2 = -2 V	VCTRL1 = 0 V VCTRL 2 = 0 V
-5	4.01	12.56	26.17	20.88	34.54	45.90
0	4.16	12.55	26.16	20.87	34.50	45.89
5	3.96	12.52	26.16	20.86	34.50	45.88
10	4.16	12.52	26.15	20.84	34.49	45.85
15	4.15	12.68	26.13	20.88	34.47	45.83

Typical Performance Data

IIP3 vs. input power at 10 GHz @ temperature 25°C						
Input Power	(dBm)					
(dBm)	VCTRL1 = -4 V VCTRL 2 = -4 V	VCTRL1 = -2 V VCTRL 2 = -4 V	VCTRL1 = 0 V VCTRL 2 = -4 V	VCTRL1 = -2 V VCTRL 2 = -2 V	VCTRL1 = 0 V VCTRL 2 = -2 V	VCTRL1 = 0 V VCTRL 2 = 0 V
5	36.04	38.53	40.14	37.29	40.34	39.63
10	36.12	38.62	40.27	37.54	40.50	39.79
15	34.51	38.96	40.41	38.13	40.71	39.93

IIP3 vs. input power at 20 GHz @ temperature 25°C						
Input Power	(dBm)					
(dBm)	VCTRL1 = -4 V VCTRL 2 = -4 V	VCTRL1 = -2 V VCTRL 2 = -4 V	VCTRL1 = 0 V VCTRL 2 = -4 V	VCTRL1 = -2 V VCTRL 2 = -2 V	VCTRL1 = 0 V VCTRL 2 = -2 V	VCTRL1 = 0 V VCTRL 2 = 0 V
5	34.23	38.19	39.89	36.67	39.86	40.12
10	34.43	38.06	40.01	36.79	40.10	40.24
15	34.28	38.24	40.15	37.27	40.19	40.39

IIP3 vs. input power at 44 GHz @ temperature 25°C						
Input Power	(dBm)					
(dBm)	VCTRL1 = -4 V VCTRL 2 = -4 V	VCTRL1 = -2 V VCTRL 2 = -4 V	VCTRL1 = 0 V VCTRL 2 = -4 V	VCTRL1 = -2 V VCTRL 2 = -2 V	VCTRL1 = 0 V VCTRL 2 = -2 V	VCTRL1 = 0 V VCTRL 2 = 0 V
5	33.88	37.44	41.49	36.01	44.92	48.67
10	33.84	37.74	42.14	36.25	45.76	51.61
15	34.18	38.21	42.47	36.70	45.65	50.85

Typical Performance Data

IIP3 vs. input power at 20 GHz @ temperature -40°C						
Input Power	(dBm)					
(dBm)	VCTRL1 = -4 V VCTRL 2 = -4 V	VCTRL1 = -2 V VCTRL 2 = -4 V	VCTRL1 = 0 V VCTRL 2 = -4 V	VCTRL1 = -2 V VCTRL 2 = -2 V	VCTRL1 = 0 V VCTRL 2 = -2 V	VCTRL1 = 0 V VCTRL 2 = 0 V
5	35.57	33.54	38.42	31.58	38.56	38.66
10	34.97	33.94	38.45	32.01	38.56	38.90
15	34.54	34.96	38.62	33.08	38.72	39.10

IIP3 vs. input power at 20 GHz @ temperature 25°C						
Input Power	(dBm)					
(dBm)	VCTRL1 = -4 V VCTRL 2 = -4 V	VCTRL1 = -2 V VCTRL 2 = -4 V	VCTRL1 = 0 V VCTRL 2 = -4 V	VCTRL1 = -2 V VCTRL 2 = -2 V	VCTRL1 = 0 V VCTRL 2 = -2 V	VCTRL1 = 0 V VCTRL 2 = 0 V
5	34.24	38.29	39.80	36.53	39.78	39.96
10	34.41	38.01	39.97	36.63	39.97	40.12
15	34.22	38.19	40.08	37.10	40.10	40.30

IIP3 vs. input power at 20 GHz @ temperature 85°C						
Input Power	(dBm)					
(dBm)	VCTRL1 = -4 V VCTRL 2 = -4 V	VCTRL1 = -2 V VCTRL 2 = -4 V	VCTRL1 = 0 V VCTRL 2 = -4 V	VCTRL1 = -2 V VCTRL 2 = -2 V	VCTRL1 = 0 V VCTRL 2 = -2 V	VCTRL1 = 0 V VCTRL 2 = 0 V
5	33.61	39.59	41.16	41.02	41.21	40.95
10	34.09	39.67	41.27	41.06	41.16	41.19
15	33.68	40.08	41.28	41.17	41.18	41.29

Voltage Variable Attenuator

Typical Performance Curves

PVA-453-34+

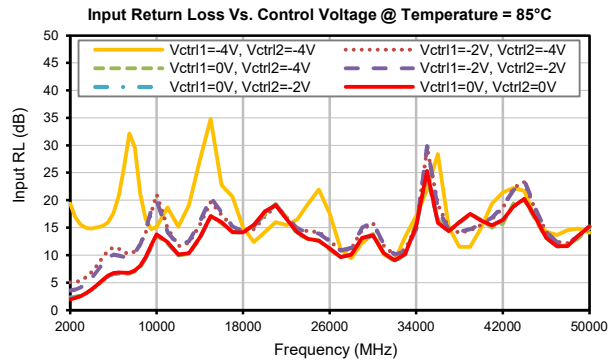
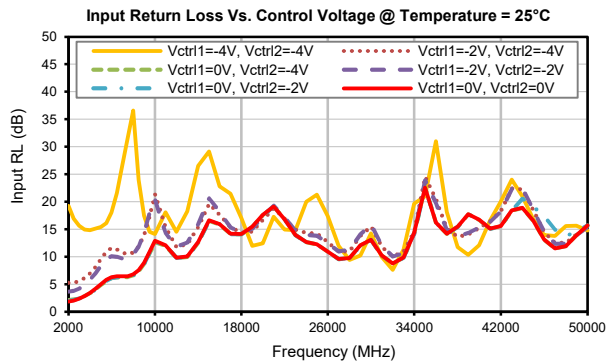
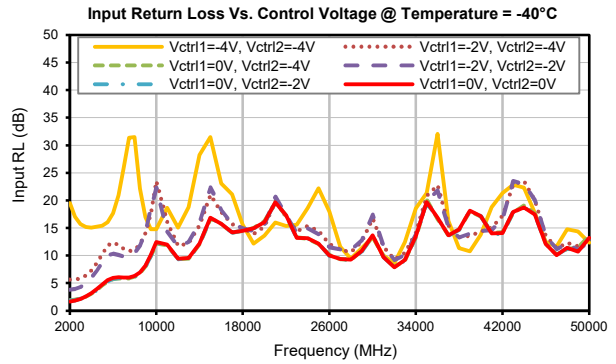
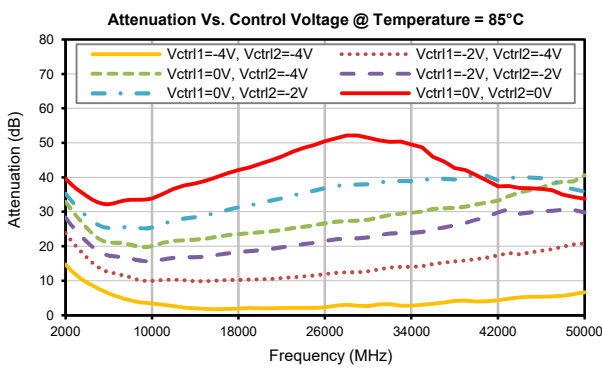
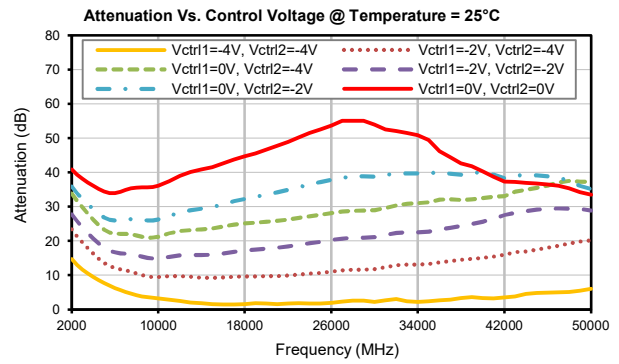
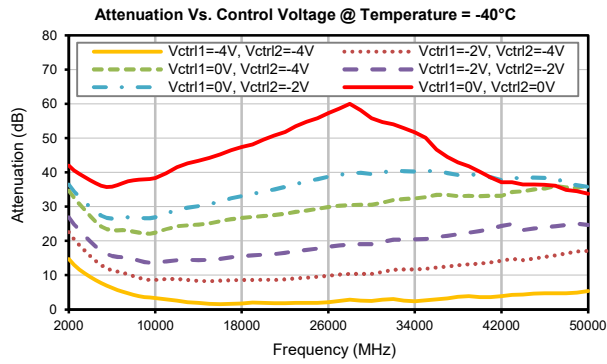

Typical Performance Curves

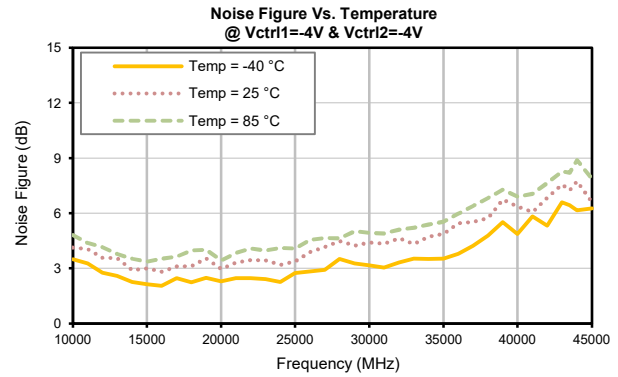
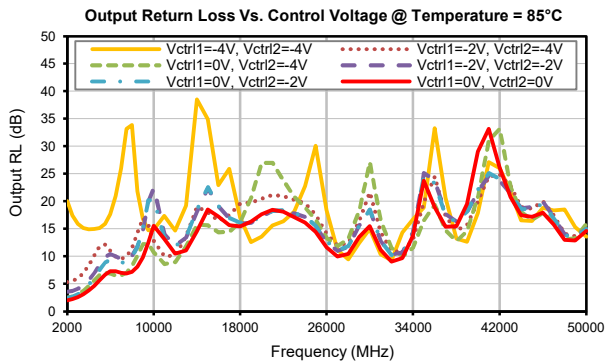
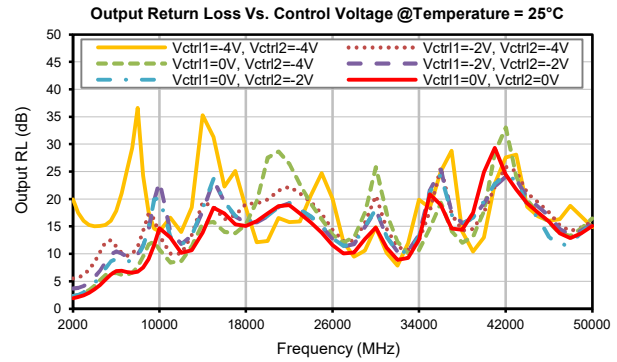
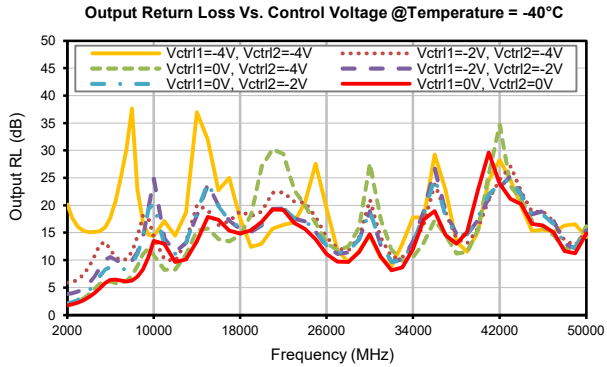

Outline Dimensions

JV2579

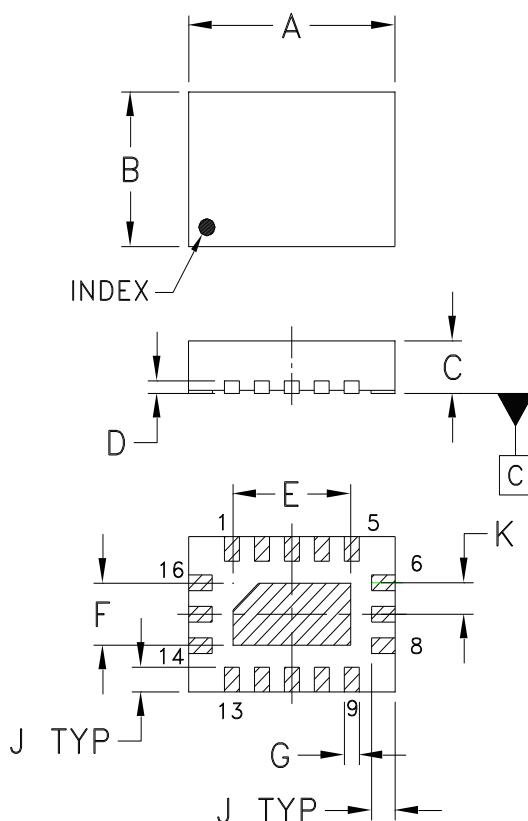

PCB Land Pattern

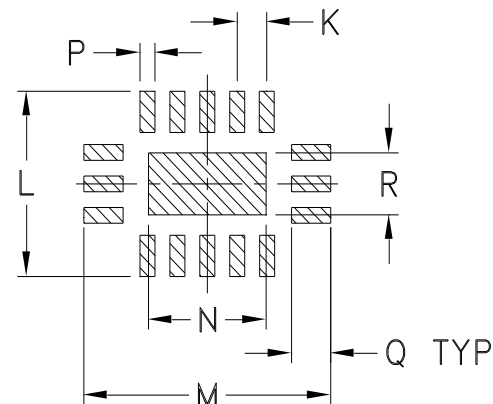

Suggested Layout,
Tolerance to be within ± 0.002

CASE #	A	B	C	D	E	F	G	H	J	K	L	M	N
JV2579	.138 (3.5)	.098 (2.5)	.033 (0.85)	.008 (0.20)	.079 (2.01)	.039 (0.99)	.010 (0.25)	-	.016 (0.41)	.020 (.51)	.118 (3.00)	.165 (4.19)	.079 (2.01)

CASE #	P	Q	R	WT. GRAM
JV2579	.010 (0.25)	.026 (0.66)	.039 (0.99)	.03

Dimensions are in inches (mm). Tolerances: 2 Pl. $\pm .01$; 3 Pl. $\pm .005$

Notes:

1. Case material: Plastic.
2. Termination finish: **as shown below or indicated on Data Sheet.**
For RoHS Case Styles: Matte-Tin plate.



P.O. Box 350166, Brooklyn, New York 11235-0003 (718) 934-4500 Fax (718) 332-4661 For detailed performance specs & shopping online see Mini-Circuits web site



The Design Engineers Search Engine Provides ACTUAL Data Instantly From MINI-CIRCUITS At: www.minicircuits.com

RF/IF MICROWAVE COMPONENTS

Tape & Reel Packaging TR-F104

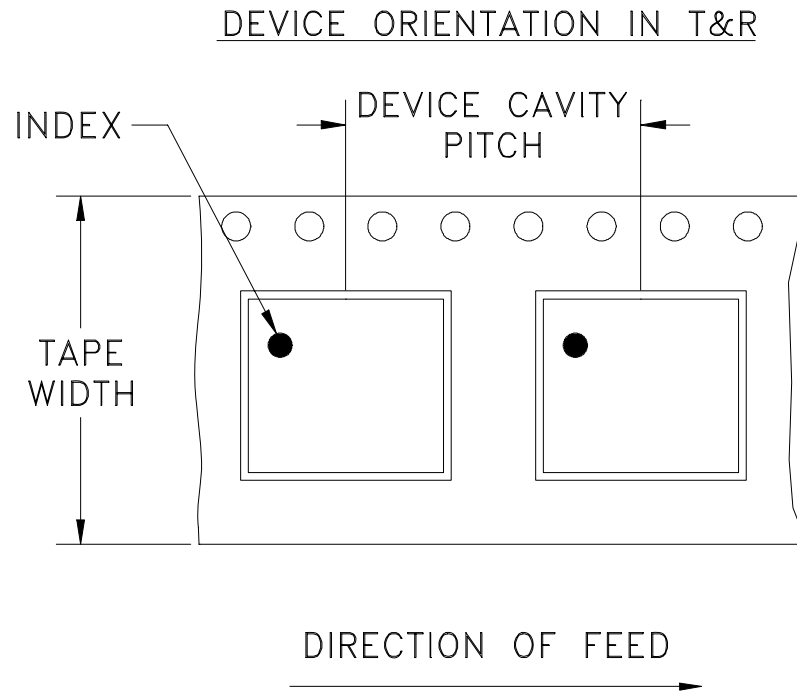

Tape Width, mm	Device Cavity Pitch, mm	Reel Size, inches	Devices per Reel	
8	4	7	Small quantity standards (see note)	20
				50
				100
				200
				500
				1000
		7	Standard	2000

Note: Please Consult individual model data sheet to determine device per reel availability.

Mini-Circuits carrier tape materials provide protection from ESD (Electro-Static Discharge) during handling and transportation. Tapes are static dissipative and comply with industry standards EIA-481/EIA-541.

Go to: www.minicircuits.com/pages/pdfs/tape.pdf



INTERNET <http://www.minicircuits.com>

P.O. Box 350166, Brooklyn, New York 11235-0003 (718) 934-4500 Fax (718) 332-4661

Distribution Centers NORTH AMERICA 800-654-7949 • 417-335-5935 • Fax 417-335-5945 • EUROPE 44-1252-832600 • Fax 44-1252-837010

Mini-Circuits ISO 9001 & ISO 14001 Certified

THIRD ANGLE PROJECTION

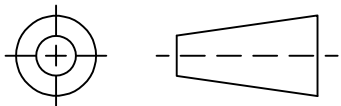

REVISIONS

REV	ECN No.	DESCRIPTION	DATE	DR	AUTH
OR	ECO-011500	NEW RELEASE	01/19/22	ITG	IL

SUGGESTED MOUNTING CONFIGURATION
FOR JV2579 CASE STYLE

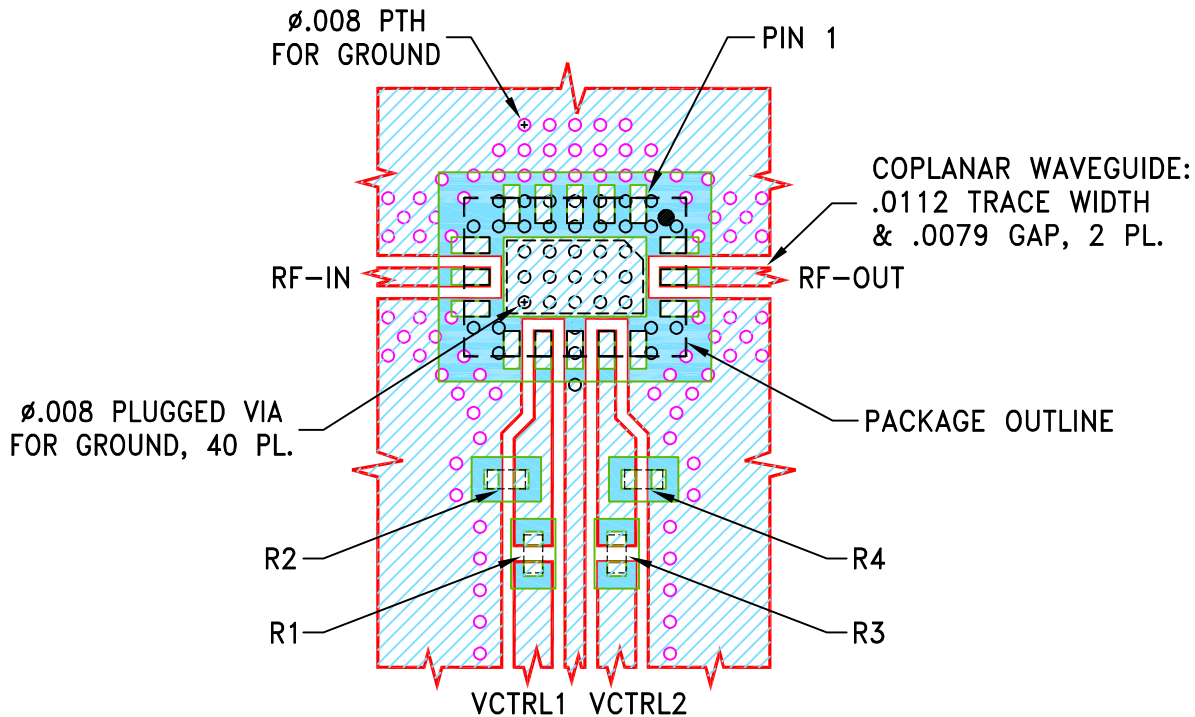

COMPONENT	SIZE
R1...R4	0201

NOTES:

1. TRACE WIDTH & GAP PARAMETERS ARE SHOWN FOR ROGERS R04350B WITH DIELECTRIC THICKNESS $.0066 \pm .0007$ ".
COPPER: 1/2 OZ. EACH SIDE. FOR OTHER MATERIALS TRACE WIDTH & GAP MAY NEED TO BE MODIFIED.
2. CHIP COMPONENT FOOT PRINTS SHOWN FOR REFERENCE. FOR COMPONENT VALUES REFER TO TB-PVA-453-34(C)+.
3. BOTTOM SIDE OF THE PCB IS CONTINUOUS GROUND PLANE.

DENOTES PCB COPPER LAYOUT WITH SMOBC (SOLDER MASK OVER BARE COPPER).

DENOTES COPPER LAND PATTERN FREE OF SOLDER MASK.

UNLESS OTHERWISE SPECIFIED	INITIALS		DATE
DIMENSIONS ARE IN INCHES	DRAWN	ITG	01/19/22
TOLERANCES ON:	CHECKED	GF	01/19/22
2 PL DECIMALS \pm	APPROVED	IL	01/19/22
3 PL DECIMALS \pm .005			
ANGLES \pm			
FRACTIONS \pm			

Mini-Circuits® 13 Neptune Avenue
Brooklyn NY 11235

PL, JV2579, TB-PVA-453-34(C)+

Mini-Circuits®
THIS DOCUMENT AND ITS CONTENTS ARE THE PROPERTY OF MINI-CIRCUITS. EXCEPT FOR USE EXPRESSLY GRANTED, IN WRITING, TO ITS VENDORS, VENDEE AND THE UNITED STATES GOVERNMENT, MINI-CIRCUITS RESERVES ALL PROPRIETARY DESIGN, USE, MANUFACTURING AND REPRODUCTION RIGHTS THERETO. THESE CONTENTS SHALL NOT BE USED, DUPLICATED OR DISCLOSED TO ANY OUTSIDE PARTY, IN WHOLE OR IN PART, WITHOUT WRITTEN PERMISSION OF MINI-CIRCUITS.

SIZE	CODE IDENT	DRAWING NO:	REV:
A	15542	98-PL-726	OR
FILE:	98PL726	SCALE: 8:1	SHEET: 1 OF 1

Evaluation Board and Circuit

SEE DETAIL "A"

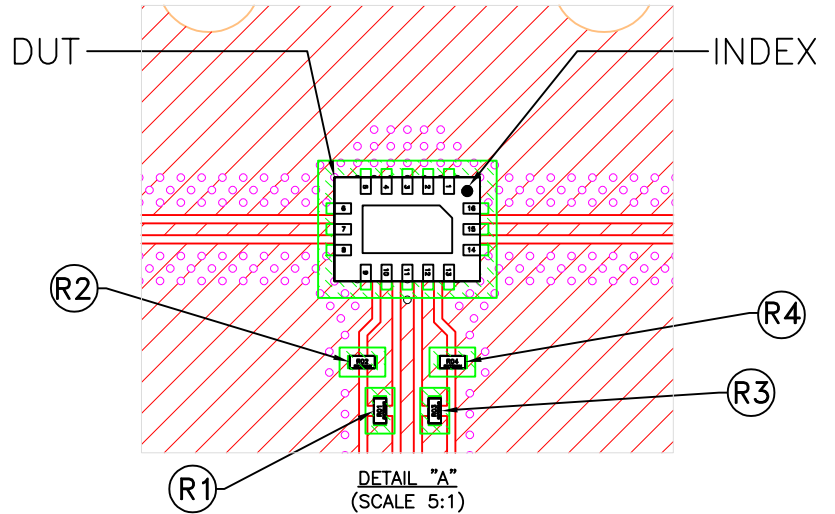
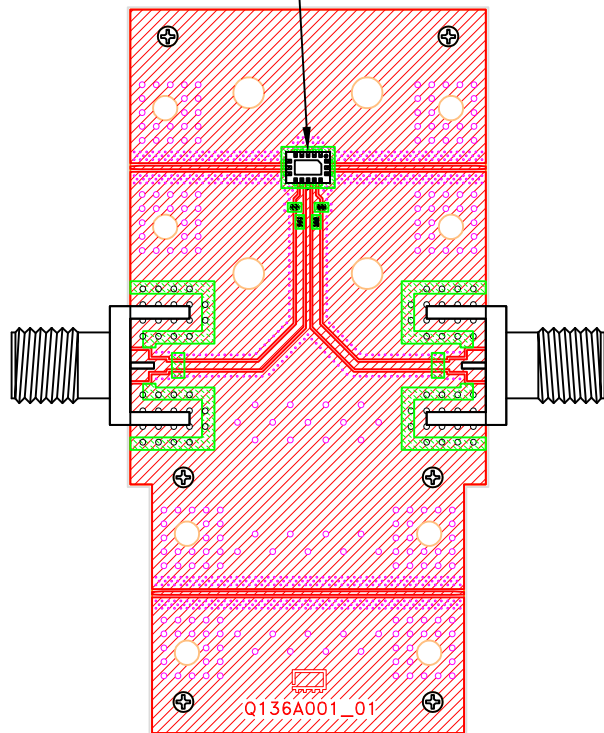

Function	Pad
RF-IN	7
RF-OUT	15
GND	6,14
NC	1,2,3,4,5,8,9,11,13,16
VCTRL1	10
VCTRL2	12

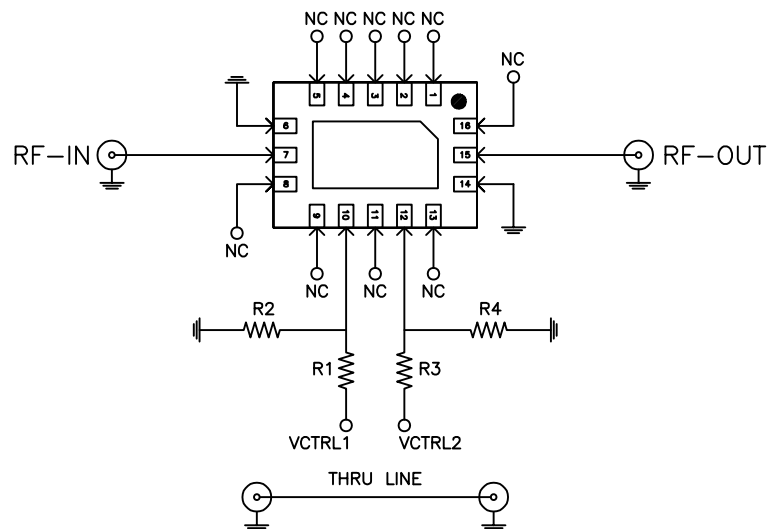

SCHEMATIC DIAGRAM
(SCALE 5:1)

Components	Size	Value	Part Numbers	Manufacturer
R1,R3	0201	6.2k Ω	RK73H1HTTC6201F	KOA Speer
R2,R4	0201	1.8k Ω	RK73H1HTTC1801F	KOA Speer

NOTES:

- 2.4mm Female Connectors.
- PCB Material: Roger R04350B or equivalent,
Dielectric constant=3.5, Thickness=0.0066 inch

 **Mini-Circuits[®]**

Evaluation Board and Circuit

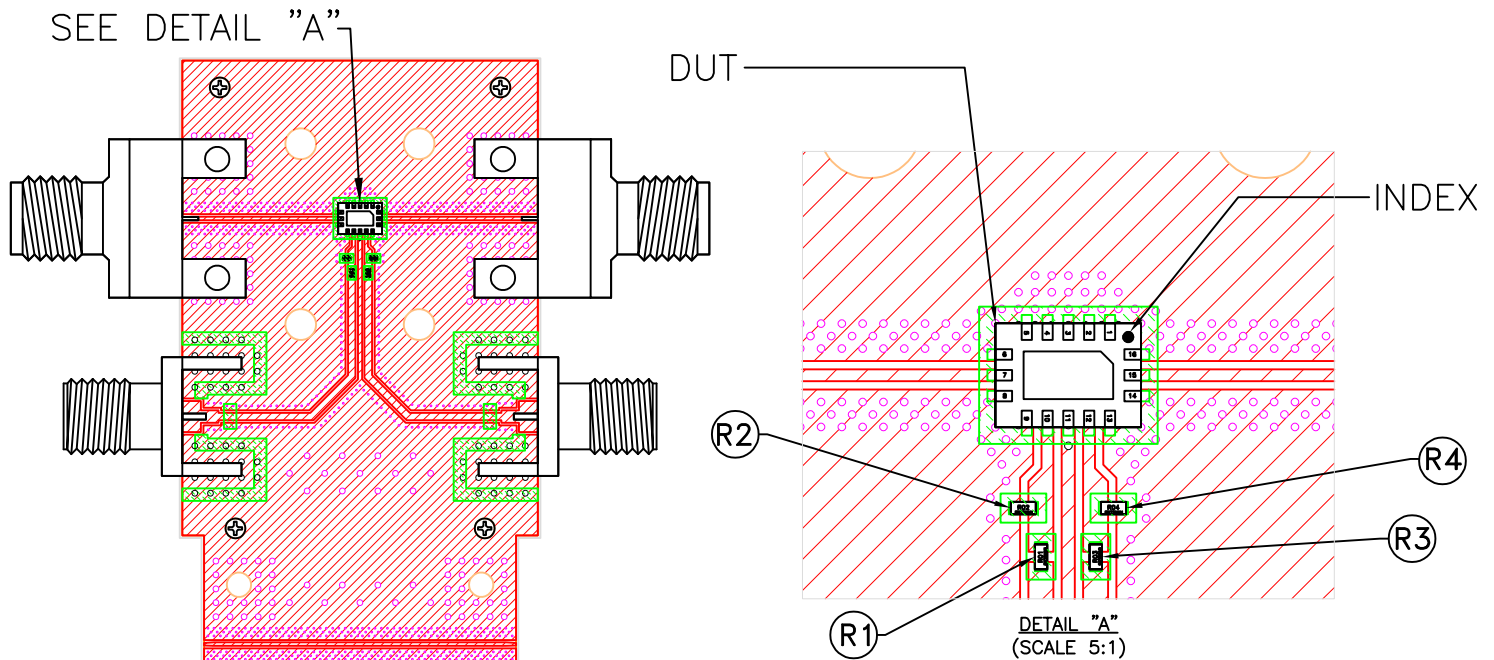

Function	Pad
RF-IN	7
RF-OUT	15
GND	6,14
NC	1,2,3,4,5,8,9,11,13,16
VCTRL1	10
VCTRL2	12

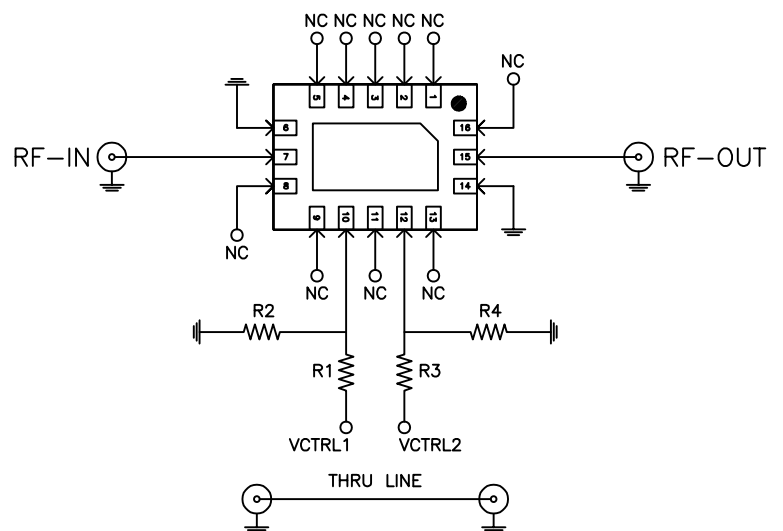

SCHEMATIC DIAGRAM
(SCALE 5:1)

Components	Size	Value	Part Numbers	Manufacturer
R1,R3	0201	6.2k Ω	RK73H1HTTC6201F	KOA Speer
R2,R4	0201	1.8k Ω	RK73H1HTTC1801F	KOA Speer

NOTES:

- 2.4mm Female Connectors.
- PCB Material: Roger R04350B or equivalent,
Dielectric constant=3.5, Thickness=0.0066 inch



All Mini-Circuits products are manufactured under exacting quality assurance and control standards, and are capable of meeting published specifications after being subjected to any or all of the following physical and environmental test.

Specification	Test/Inspection Condition	Reference/Spec
Operating Temperature	-40° to 85°C or -45° to 85°C Ambient Environment	Individual Model Data Sheet
Storage Temperature	-55° to 100° C or -65° to 150° Ambient Environment	Individual Model Data Sheet
Thermal Shock	-55° to 100°C, 100 cycles	MIL-STD-202, Method 107, Condition A-3, except +100°C
Mechanical Shock	1.5Kg, 0.5 ms, 5 shock pulses, Y1 direction only	MIL-STD-883, Method 2002, Condition B, except Y1 direction only
Vibration (Variable Frequency)	50g peak	MIL-STD-883, Method 2007, Condition B
Autoclave	15 psig, 100% RH, 121°C, 96 hours	JESD22-A102, Condition C
HAST	130°C, 85% RH, 96 hours	JESD22-A110
Solderability	10X Magnification	J-STD-002, Para 4.2.5, Test S, 95% Coverage
Solder Reflow Heat	Sn-Pb Eutetic Process: 240°C peak Pb-Free Process: 260°C peak	J-STD-020, Table 4-1, 4-2 and 5-2; Figure 5-1
Moisture Sensitivity: Level 1	Bake at 125°C for 24 hours Soak at 85°C/85% RH for 168 hours, Reflow 3 cycles at 260°C peak	J-STD-020
Marking Resistance to Solvents	Isopropyl alcohol + mineral spirits at 25°C; terpene defluxer at 25°C; distilled water + proylene glycol monomethyl ether +	MIL-STD-202, Method 215



All Mini-Circuits products are manufactured under exacting quality assurance and control standards, and are capable of meeting published specifications after being subjected to any or all of the following physical and environmental test.

Specification	Test/Inspection Condition	Reference/Spec
	monoethanolamine at 63°C to 70°C	