



MMIC SURFACE MOUNT

Low Noise Amplifier

PMA3-10203+

Mini-Circuits

50Ω 12.5 to 20 GHz Shutdown Feature

THE BIG DEAL

- Low Noise Figure, Typ. 1.5 dB
- High OIP3, Typ. +24 dBm
- High P1dB, Typ. +16 dBm
- Shutdown Feature
- Single +5 V Supply Voltage
- 3x3 mm, 16-Lead QFN-Style Package

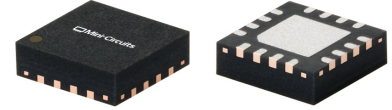

Generic photo used for illustration purposes only

APPLICATIONS

- Test & Measurement Equipment
- Back Haul Radio Systems
- Satellite Communications
- Radar, EW, and ECM Defense Systems

FUNCTIONAL DIAGRAM

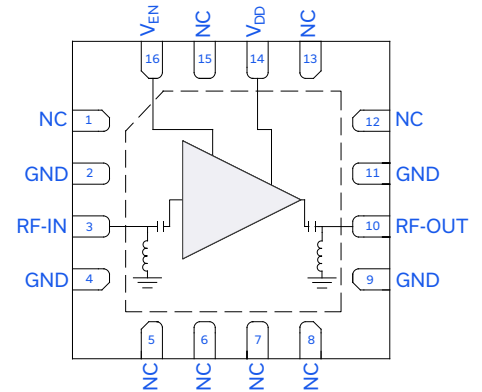

PRODUCT OVERVIEW

The PMA3-10203+ is a pHEMT-based wideband, ultra-low noise MMIC amplifier with high IP3, flat gain, and voltage-controlled shutdown capability. Operating from 12.5 to 20 GHz, this amplifier features high dynamic range with typical 1.5 dB noise figure, 21 dB gain, +16 dBm P1dB, and +24 dBm OIP3. This combination of characteristics makes it ideal for sensitive, high dynamic range receiver applications. The device is internally DC blocked, and a DC path to ground is present at the RF input and output ports for ESD protection. PMA3-10203+ operates on a single +5 V supply, is well matched to 50Ω, and comes in a small, low profile 3x3 mm QFN-style package for easy integration into dense circuit board layouts.

KEY FEATURES

Features	Advantages
Low Noise Figure, Typ. 1.5 dB	This ultra-low noise MMIC device enables low system noise figure performance without the need for complicated discrete-based solutions.
High Dynamic Range <ul style="list-style-type: none"> • Gain, Typ. 21 dB • OIP3, Typ. +24 dBm • P1dB, Typ. +16 dBm 	The MMIC amplifier's unique combination of low noise figure, high gain, high P1dB, and high OIP3 enables optimum performance in sensitive high dynamic range receivers.
Shutdown Feature	A shutdown feature allows the part to be quickly disabled to conserve power when not in use.
3x3mm 16-Lead QFN-Style Package	Small footprint saves space in dense layouts while providing low inductance, repeatable transitions, and excellent thermal contact to the PCB. Industry-standard packaging allows for ease of assembly in high-volume manufacturing processes.





MMIC SURFACE MOUNT

Low Noise Amplifier

PMA3-10203+

Mini-Circuits

50Ω 12.5 to 20 GHz Shutdown Feature

ELECTRICAL SPECIFICATIONS¹ AT +25°C, V_{DD} = +5 V, V_{EN} = +5 V UNLESS NOTED OTHERWISE

Parameter	Condition (GHz)	Min.	Typ.	Max.	Units
Frequency Range		12.5		20	GHz
Gain	12.5	17.5	20.8		dB
	14	18.0	21.3		
	16	19.2	22.2		
	18	17.8	20.7		
	20	15.5	18.8		
Input Return Loss	12.5		13		dB
	14		9		
	16		8		
	18		8		
	20		9		
Output Return Loss	12.5		19		dB
	14		15		
	16		12		
	18		20		
	20		15		
Isolation	12.5 - 20		48		dB
Output Power at 1 dB Compression (P _{1dB})	12.5		+15.2		dBm
	14		+16.0		
	16		+16.1		
	18		+16.4		
	20		+15.7		
Output Third-Order Intercept (P _{OUT} = +5 dBm/Tone)	12.5		+23		dBm
	14		+25		
	16		+25		
	18		+24		
	20		+23		
Noise Figure	12.5		1.4		dB
	14		1.3		
	16		1.4		
	18		1.5		
	20		2.1		
FALL Time (90% RF to 10% RF) ²			13		ns
RISE Time (10% RF to 90% RF) ²			108		ns
Device Operating Voltage (V _{DD})		+4.75	+5	+5.25	V
Device Operating Current (I _{DD}) ³			56		mA
Enable Voltage (V _{EN}) ⁴		+4.75	+5	+5.25	V
Enable Current (I _{EN}) at V _{EN} = +5 V			0.86		mA
DC Current Variation vs. Temperature ⁵			-86.7		μA/°C
DC Current Variation vs. Voltage ⁶			0.004		mA/mV

1. Tested on Mini-Circuits Characterization Test Board TB-PMA3-10203C+. See Figure 2. Board loss de-embedded to the device.

2. Measured with bypass capacitors C2 and C4 removed from TB-PMA3-10203C+.

3. Current at P_N = -25 dBm. Increases to 61 mA at P_{1dB}.4. V_{EN} ≤ V_{DD} under nominal operating conditions.

5. (Current at +105°C - Current at -45°C) / (+150°C)

6. (Current at +5.25 V - Current at +4.75 V) / (+5.25 V - +4.75 V)





TYPICAL PERFORMANCE GRAPHS

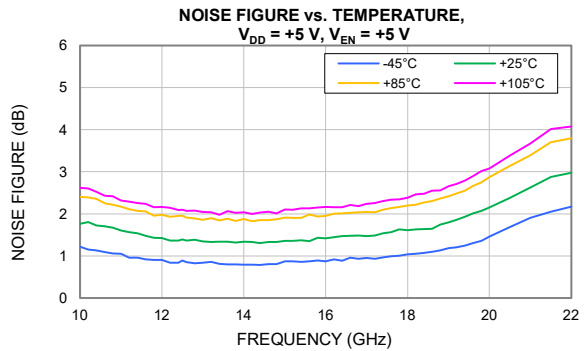
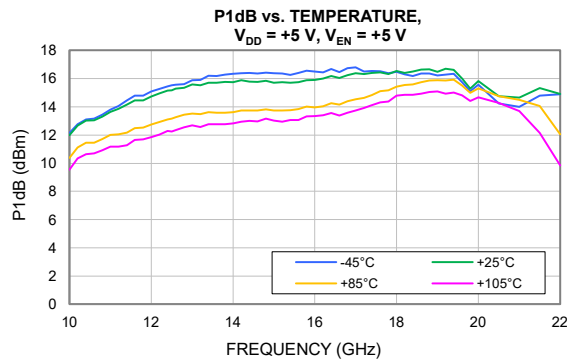
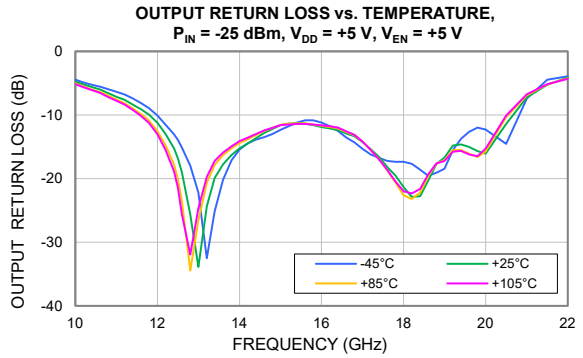
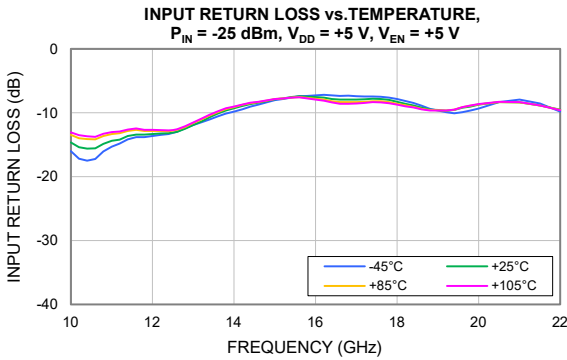
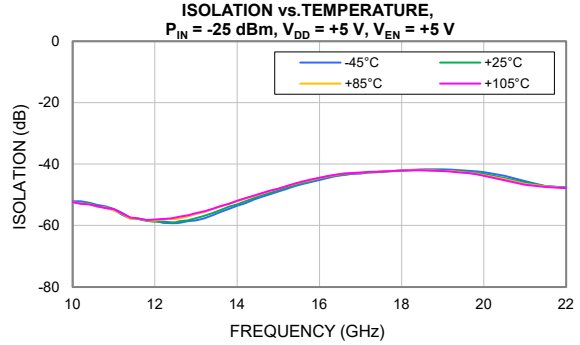
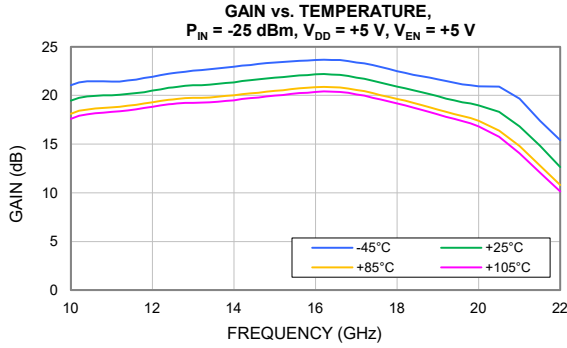



TYPICAL PERFORMANCE GRAPHS

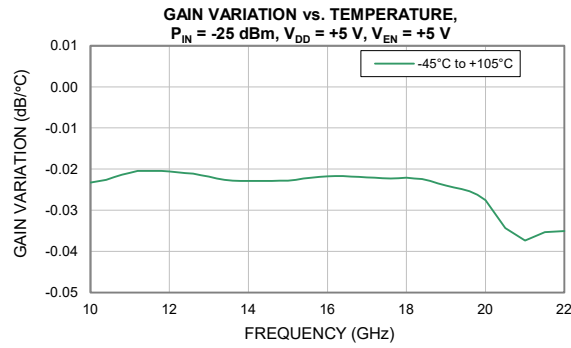
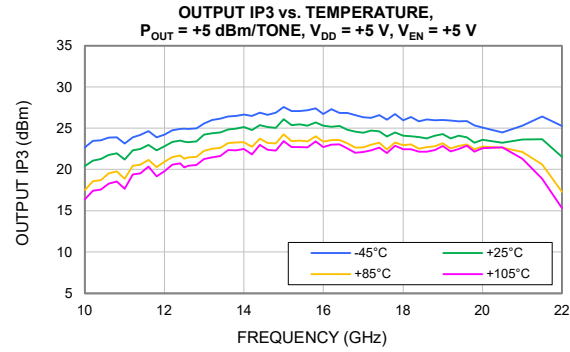
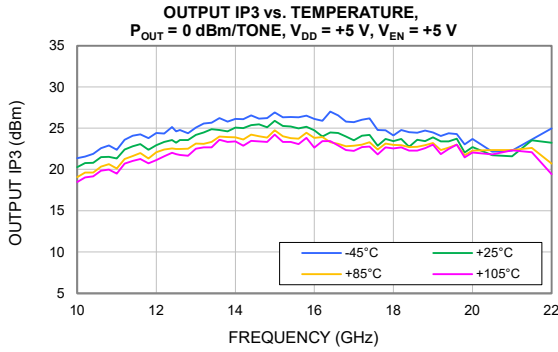



MMIC SURFACE MOUNT

Low Noise Amplifier

PMA3-10203+

Mini-Circuits

50Ω 12.5 to 20 GHz Shutdown Feature

ABSOLUTE MAXIMUM RATINGS⁷

Parameter	Ratings
Operating Temperature	-45°C to +105°C
Storage Temperature	-65°C to +150°C
Junction Temperature ⁸	+150°C
Total Power Dissipation	0.7 W
Input Power (CW), V _{DD} = +5 V	+19 dBm
DC Voltage at V _{DD}	+7 V
Current I _{DD}	100 mA
DC Voltage at V _{EN}	+7 V

7. Permanent damage may occur if any of these limits are exceeded. Maximum ratings are not intended for continuous normal operation.

8. Peak temperature on top of Die.

ENABLE VOLTAGE (V_{EN})

	Min.	Typ.	Max.	Units
Amplifier-ON	+4.75	+5.0	+5.25	V
Amplifier-OFF	0	-	+1.5	V

THERMAL RESISTANCE

Parameter	Ratings
Thermal Resistance (Θ _{JC}) ⁹	61.1°C/W

9. Θ_{JC} = (Hot Spot Temperature on Die - Temperature at Ground Lead)/Dissipated Power

ESD RATING

	Class	Voltage Range	Reference Standard
HBM	1C	1000 V to < 2000 V	ANSI/ESDA/JEDEC JS-001-2017
CDM	C3	≥1000 V	JESD22-C101F



ESD HANDLING PRECAUTION: This device is designed to be Class 1C for HBM. Static charges may easily produce potentials higher than this with improper handling and can discharge into DUT and damage it. As a preventive measure Industry standard ESD handling precautions should be used at all times to protect the device from ESD damage.

MSL RATING

Moisture Sensitivity: MSL1 in accordance with IPC/JEDEC J-STD-020E /JEDEC J-STD-033C



FUNCTIONAL DIAGRAM

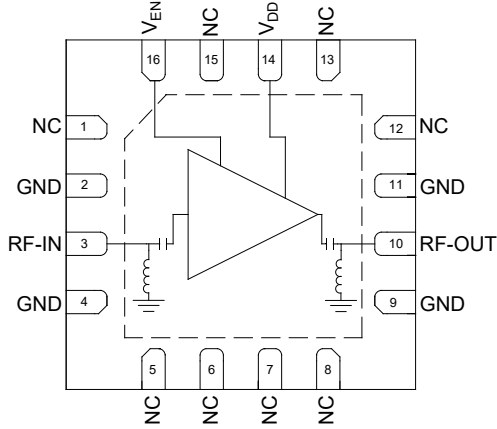

Figure 1. PMA3-10203+ Functional Diagram

PAD DESCRIPTION

Function	Pad Number	Description (Refer to Figure 2)
RF-IN	3	RF-IN Pad connects to RF Input port.
RF-OUT	10	RF-OUT Pad connects to RF Output port.
V _{DD}	14	DC Input Pad connects to voltage input port V _{DD} .
V _{EN}	16	DC Input Pad connects to enable voltage input port V _{EN} .
GND	2, 4, 9, 11 & Paddle	Connects to ground.
NC	1, 5-8, 12, 13, 15	Not used internally. Connected to ground on test board.

CHARACTERIZATION TEST BOARD

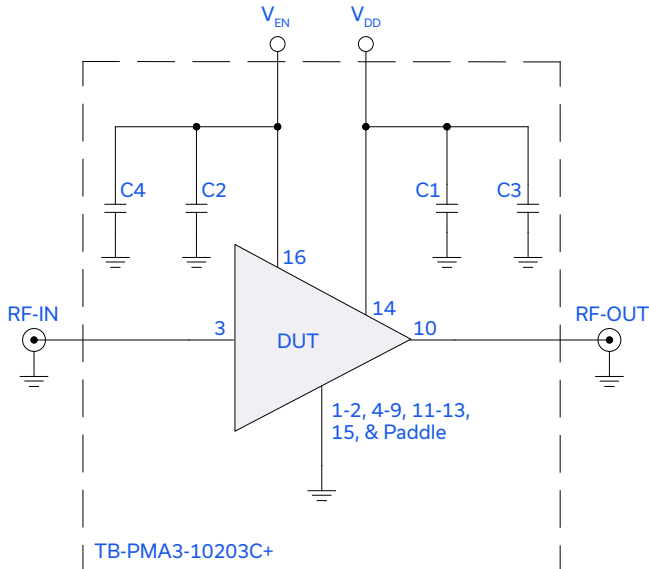

Figure 2. PMA3-10203+ Characterization and Application Circuit.

Electrical Parameters and Conditions

Gain, Return Loss, Output Power at 1dB Compression (P1dB), Output IP3 (OIP3), and Noise Figure measured using N5242A PNA-X Microwave Network Analyzer. For Switching Speed measurements, bypass capacitors C2 and C4 were removed from TB-PMA3-10203C+.

Conditions:

- Gain and Return Loss: P_{IN} = -25 dBm
- Output IP3 (OIP3): Two tones, spaced 1 MHz apart, +5 dBm/Tone at output.
- V_{DD} = +5 V

Component	Vendor	Vendor P/N	Value	Size
C1, C2	Murata	GRM1555C1H101JA01D	100 pF	0402
C3, C4	Murata	GRM155R71H104KE14J	0.1 μF	0402

Power ON/Power OFF Sequence:

Parts are not sensitive to power ON/OFF sequence. V_{DD} and V_{EN} can be applied in any order.



MMIC SURFACE MOUNT

Low Noise Amplifier

PMA3-10203+

Mini-Circuits

50Ω 12.5 to 20 GHz Shutdown Feature

CASE STYLE DRAWING

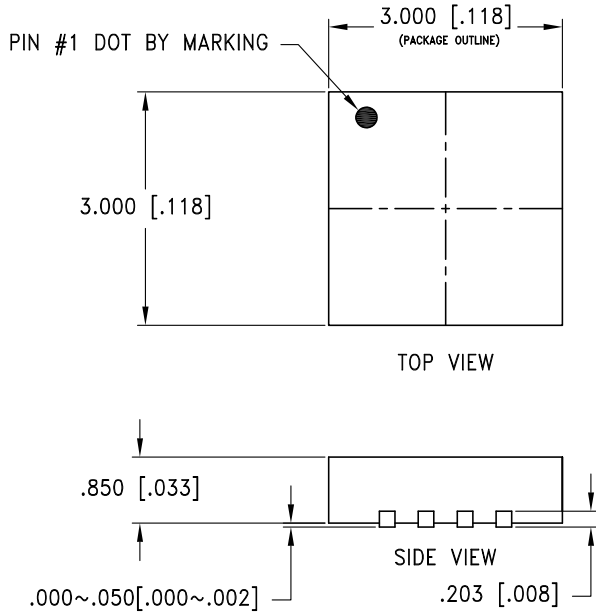

PCB Land Pattern

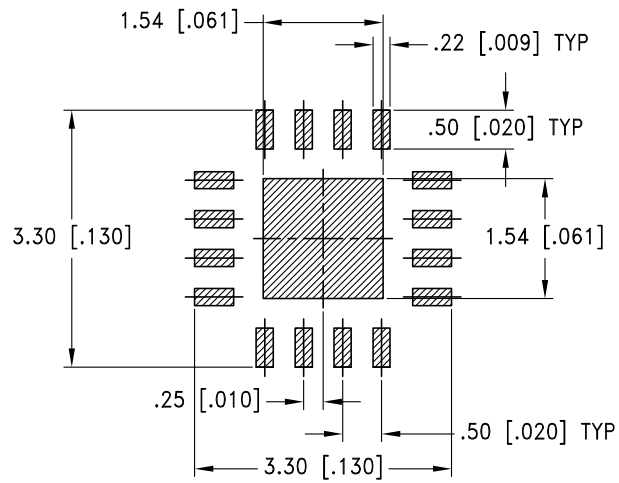

Suggested Layout

Tolerances to be within ± 0.05 [.002]

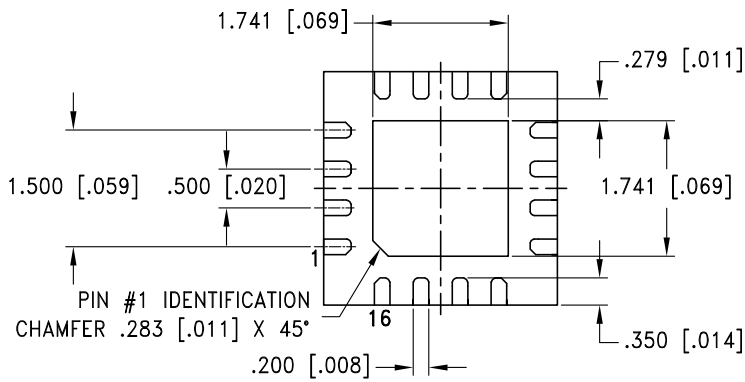

Weight: .02 grams

Dimensions are in mm [Inches]. Tolerances: 3 Pl. ± 0.05 [.002]

PRODUCT MARKING

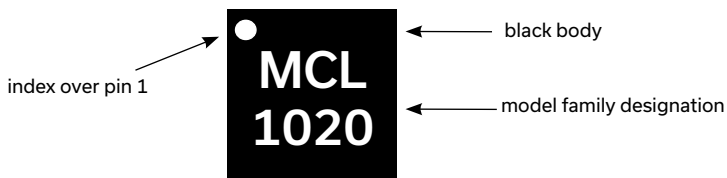

Marking may contain other features or characters for internal lot control



MMIC SURFACE MOUNT

Low Noise Amplifier

PMA3-10203+

Mini-Circuits

50Ω 12.5 to 20 GHz Shutdown Feature

ADDITIONAL DETAILED INFORMATION IS AVAILABLE ON OUR DASH BOARD [CLICK HERE](#)

Performance Data	Data Graphs S-Parameter (S2P Files) Data Set (.zip file)
Case Style	DQ3005. Plastic package, exposed paddle, lead finish: Matte-Tin
RoHS Status	Compliant
Tape & Reel Standard quantities available on reel	F104 7" reels with 20, 50, 100, 200, 500, 1000, or 2000 devices
Suggested Layout for PCB Design	PL-784
Evaluation Board	TB-PMA3-10203C+ Gerber File
Environmental Ratings	ENV08T1

NOTES

- A. Performance and quality attributes and conditions not expressly stated in this specification document are intended to be excluded and do not form a part of this specification document.
- B. Electrical specifications and performance data contained in this specification document are based on Mini-Circuit's applicable established test performance criteria and measurement instructions.
- C. The parts covered by this specification document are subject to Mini-Circuits standard limited warranty and terms and conditions (collectively, "Standard Terms"); Purchasers of this part are entitled to the rights and benefits contained therein. For a full statement of the standard terms and the exclusive rights and remedies thereunder, please visit Mini-Circuits' website at www.minicircuits.com/terms/viewterm.html



Typical Performance Data

NOTE: Use PDF Bookmarks to view DATA at required conditions

Definitions:

Input Return Loss = -S11 (dB)

Gain(Power Gain) = S21 (dB)

Reverse Isolation = -S12 (dB)

Output Return Loss = -S22 (dB)

TEST CONDITIONS: $V_{DD} = +5\text{ V}$, $I_{DD} = 54\text{ mA}$ @ Temperature = +25°C

FREQ	Gain	Isolation	Input Return Loss	Output Return Loss	Stability		IP-3 Output $P_{OUT} = 0\text{ dBm/ Tone}$	IP-3 Output $P_{OUT} = +5\text{ dBm/ Tone}$	1dB Comp. Output	Noise Figure
					K	Measure				
(GHz)	(dB)	(dB)	(dB)	(dB)			(dBm)	(dBm)	(dBm)	(dB)
10.0	19.47	52.30	14.67	4.73	17.75	0.74	20.28	20.42	11.99	1.77
10.2	19.75	52.71	15.39	5.22	19.10	0.76	20.77	21.07	12.66	1.80
10.4	19.89	52.79	15.62	5.60	21.30	0.79	20.81	21.28	13.04	1.72
10.6	19.95	53.66	15.57	5.99	22.31	0.81	21.48	21.75	13.05	1.71
10.8	20.00	54.24	14.85	6.56	25.09	0.83	21.51	21.96	13.30	1.67
11.0	20.04	54.89	14.40	7.11	27.70	0.85	21.34	21.20	13.64	1.60
11.2	20.07	56.48	14.17	7.65	33.46	0.88	22.42	22.31	13.85	1.56
11.4	20.16	57.78	13.65	8.35	36.99	0.90	22.81	22.49	14.16	1.54
11.6	20.24	57.96	13.39	9.10	36.78	0.93	23.08	22.97	14.46	1.48
11.8	20.35	58.52	13.42	9.93	40.84	0.96	22.39	22.32	14.46	1.43
12.0	20.48	58.79	13.33	11.25	51.30	0.98	22.94	22.82	14.73	1.43
12.2	20.63	58.77	13.25	12.98	49.98	1.00	23.34	23.34	14.94	1.37
12.4	20.77	59.01	13.22	15.23	50.90	1.03	23.55	23.51	15.14	1.37
12.5	20.83	58.98	13.14	16.85	52.85	1.04	23.22	23.37	15.16	1.39
12.6	20.88	58.59	12.99	18.99	53.43	1.04	23.57	23.32	15.28	1.37
12.8	20.98	58.31	12.49	25.65	38.72	1.06	23.55	23.41	15.34	1.39
13.0	21.03	57.55	11.94	33.86	39.87	1.07	24.21	24.24	15.60	1.35
13.2	21.07	56.86	11.33	24.38	36.94	1.08	24.46	24.39	15.52	1.33
13.4	21.13	55.93	10.72	19.92	31.52	1.08	24.89	24.51	15.72	1.35
13.6	21.19	54.93	10.13	17.74	26.42	1.09	24.81	24.86	15.71	1.34
13.8	21.28	53.86	9.63	16.31	22.56	1.09	24.63	24.96	15.76	1.32
14.0	21.36	53.13	9.29	15.26	19.14	1.10	25.07	25.17	15.74	1.34
14.2	21.48	52.05	8.94	14.48	17.22	1.11	24.99	24.80	15.87	1.33
14.4	21.57	51.12	8.64	13.65	15.45	1.11	25.38	25.37	15.79	1.31
14.6	21.65	50.16	8.44	12.83	13.59	1.12	25.47	25.15	15.76	1.33
14.8	21.74	49.35	8.19	12.18	11.50	1.12	25.13	25.02	15.84	1.33
15.0	21.81	48.57	7.89	11.59	10.49	1.11	25.91	26.11	15.69	1.36
15.2	21.89	47.72	7.74	11.35	9.21	1.10	25.26	25.36	15.75	1.36
15.4	21.98	46.99	7.57	11.29	8.42	1.10	25.22	25.48	15.71	1.37
15.6	22.05	46.20	7.41	11.35	7.57	1.09	24.98	25.30	15.74	1.36
15.8	22.11	45.50	7.48	11.61	6.82	1.09	25.19	25.72	15.89	1.43
16.0	22.18	44.86	7.56	11.88	6.49	1.10	24.75	25.29	15.90	1.42
16.2	22.20	44.27	7.64	12.13	6.14	1.10	24.00	25.18	16.00	1.45
16.4	22.16	43.73	7.83	12.40	5.83	1.11	24.50	25.28	16.18	1.47
16.6	22.12	43.44	7.95	12.90	5.67	1.12	24.40	24.82	16.04	1.48
16.8	22.00	43.16	7.94	13.33	5.66	1.12	24.01	24.60	16.24	1.49
17.0	21.84	42.93	7.91	14.24	5.62	1.13	23.52	24.43	16.38	1.48
17.2	21.71	42.76	7.87	15.35	5.70	1.14	24.09	24.71	16.32	1.49
17.4	21.51	42.61	7.79	16.57	5.78	1.14	24.18	24.63	16.39	1.54
17.6	21.31	42.51	7.82	18.17	5.99	1.14	22.89	24.00	16.45	1.56
17.8	21.11	42.35	7.99	19.53	6.27	1.14	23.71	24.51	16.32	1.63
18.0	20.90	42.17	8.26	21.30	6.28	1.14	23.43	24.09	16.53	1.62
18.2	20.74	41.98	8.59	22.86	6.25	1.13	23.69	24.03	16.39	1.63
18.4	20.54	41.94	8.87	22.79	6.53	1.13	22.77	23.95	16.49	1.64
18.6	20.35	41.93	9.23	20.32	6.55	1.12	23.63	23.78	16.65	1.65
18.8	20.14	41.97	9.49	17.72	6.93	1.12	23.44	24.07	16.66	1.74
19.0	19.92	42.02	9.57	16.72	6.95	1.11	23.90	24.29	16.48	1.80
19.2	19.67	42.19	9.68	14.82	7.21	1.11	23.41	23.78	16.69	1.86
19.4	19.49	42.37	9.56	14.62	7.64	1.11	23.42	24.08	16.63	1.93
19.6	19.31	42.64	9.23	15.00	7.73	1.10	23.74	23.91	16.00	2.02
19.8	19.18	42.81	9.00	15.68	8.14	1.09	22.04	23.22	15.28	2.08
20.0	18.99	43.19	8.73	16.09	8.57	1.08	22.69	23.60	15.82	2.15
20.5	18.32	44.54	8.30	11.38	10.75	1.03	21.73	23.23	14.74	2.38
21.0	16.82	46.05	8.39	7.22	12.82	0.90	21.61	23.65	14.67	2.62
21.5	14.82	47.16	8.87	5.27	15.83	0.78	23.53	23.69	15.32	2.88
22.0	12.65	47.66	9.54	4.09	19.41	0.69	23.23	21.53	14.90	2.98

Typical Performance Data

NOTE: Use PDF Bookmarks to view DATA at required conditions

Definitions:

Input Return Loss = -S11 (dB)

Gain(Power Gain) = S21 (dB)

Reverse Isolation = -S12 (dB)

Output Return Loss = -S22 (dB)

TEST CONDITIONS: $V_{DD} = +5\text{ V}$, $I_{DD} = 60\text{ mA}$ @ Temperature = -45°C

FREQ	Gain	Isolation	Input Return Loss	Output Return Loss	Stability		IP-3 Output $P_{OUT} = 0\text{ dBm/}$ Tone	IP-3 Output $P_{OUT} = +5\text{ dBm/}$ Tone	1dB Comp. Output	Noise Figure
					K	Measure				
(GHz)	(dB)	(dB)	(dB)	(dB)			(dBm)	(dBm)	(dBm)	(dB)
10.0	21.08	52.1	16.00	4.44	12.19	0.66	21.37	22.69	12.15	1.21
10.2	21.34	52.1	17.21	4.90	12.64	0.69	21.59	23.47	12.76	1.15
10.4	21.44	52.6	17.50	5.24	13.65	0.72	21.91	23.53	13.11	1.13
10.6	21.45	53.4	17.22	5.52	15.33	0.74	22.57	23.85	13.16	1.09
10.8	21.44	53.8	16.05	5.93	16.57	0.77	22.91	23.87	13.44	1.06
11.0	21.43	54.5	15.28	6.33	18.65	0.79	22.38	23.14	13.81	1.05
11.2	21.44	55.9	14.83	6.75	22.27	0.82	23.61	23.90	14.05	0.96
11.4	21.54	57.5	14.15	7.40	27.65	0.85	24.08	24.19	14.44	0.96
11.6	21.65	57.9	13.80	8.15	29.13	0.88	24.27	24.65	14.78	0.92
11.8	21.78	58.3	13.81	8.96	31.04	0.91	23.78	23.92	14.79	0.91
12.0	21.93	58.4	13.65	10.10	32.10	0.94	24.40	24.24	15.08	0.90
12.2	22.09	59.1	13.45	11.50	35.09	0.97	24.34	24.74	15.27	0.84
12.4	22.22	59.3	13.32	13.02	35.90	0.99	25.15	24.90	15.45	0.84
12.5	22.29	59.2	13.18	13.94	35.59	1.00	24.63	24.94	15.52	0.89
12.6	22.34	59.1	12.97	15.07	35.45	1.02	24.80	24.92	15.57	0.85
12.8	22.45	58.6	12.43	18.00	33.23	1.04	24.39	24.98	15.61	0.83
13.0	22.53	58.4	11.93	22.17	32.22	1.06	25.07	25.57	15.88	0.84
13.2	22.61	57.7	11.47	32.52	29.35	1.07	25.55	26.01	15.91	0.86
13.4	22.70	56.7	11.04	25.14	25.83	1.08	25.66	26.17	16.20	0.81
13.6	22.78	55.6	10.56	20.16	22.12	1.08	26.22	26.43	16.17	0.81
13.8	22.87	54.6	10.14	17.15	19.21	1.08	25.81	26.48	16.29	0.80
14.0	22.95	53.6	9.83	15.41	16.65	1.07	26.14	26.66	16.34	0.79
14.2	23.06	52.7	9.44	14.45	14.60	1.07	26.09	26.49	16.38	0.79
14.4	23.15	51.6	9.02	13.85	12.45	1.08	26.54	26.90	16.40	0.79
14.6	23.23	50.7	8.70	13.44	10.99	1.08	26.16	26.62	16.35	0.81
14.8	23.33	49.9	8.39	13.00	9.71	1.09	26.21	26.89	16.43	0.81
15.0	23.40	49.0	8.04	12.34	8.49	1.09	26.93	27.56	16.37	0.88
15.2	23.45	48.1	7.83	11.76	7.50	1.09	26.33	27.06	16.37	0.87
15.4	23.51	47.2	7.63	11.20	6.60	1.09	26.37	27.06	16.28	0.86
15.6	23.55	46.5	7.42	10.84	5.97	1.08	26.34	27.19	16.39	0.88
15.8	23.58	45.9	7.35	10.86	5.54	1.08	26.51	27.40	16.55	0.89
16.0	23.65	45.2	7.30	11.21	5.10	1.09	26.12	26.72	16.50	0.88
16.2	23.66	44.6	7.21	11.74	4.78	1.10	25.89	27.30	16.44	0.92
16.4	23.64	44.0	7.26	12.49	4.58	1.10	27.00	26.84	16.69	0.89
16.6	23.64	43.6	7.34	13.53	4.45	1.11	26.57	26.85	16.46	0.96
16.8	23.54	43.2	7.34	14.31	4.38	1.12	25.80	26.59	16.73	0.94
17.0	23.41	43.0	7.38	15.33	4.40	1.12	25.74	26.34	16.80	0.96
17.2	23.30	42.7	7.44	16.20	4.36	1.13	26.03	26.27	16.49	0.94
17.4	23.11	42.7	7.43	16.76	4.43	1.13	26.19	26.59	16.54	0.97
17.6	22.93	42.4	7.48	17.23	4.45	1.13	24.77	26.03	16.52	1.00
17.8	22.72	42.3	7.62	17.34	4.52	1.13	24.74	26.71	16.38	1.00
18.0	22.49	42.1	7.84	17.35	4.56	1.12	24.11	25.97	16.48	1.04
18.2	22.32	41.9	8.16	17.67	4.63	1.11	24.81	26.37	16.30	1.06
18.4	22.13	41.8	8.45	18.56	4.73	1.11	24.54	25.84	16.18	1.08
18.6	21.97	41.8	8.91	19.55	4.89	1.10	24.46	26.07	16.35	1.10
18.8	21.83	41.7	9.36	19.03	5.03	1.09	24.71	25.97	16.35	1.13
19.0	21.67	41.7	9.64	18.46	5.14	1.08	24.47	26.01	16.22	1.19
19.2	21.47	41.8	9.95	15.47	5.32	1.06	24.05	25.92	16.29	1.21
19.4	21.31	42.0	10.08	13.74	5.47	1.04	24.37	25.84	16.34	1.25
19.6	21.15	42.1	9.87	12.63	5.58	1.03	24.29	25.85	15.75	1.31
19.8	21.05	42.4	9.63	11.98	5.73	1.03	23.04	25.33	15.11	1.36
20.0	20.94	42.7	9.34	12.28	5.96	1.04	23.69	25.08	15.58	1.47
20.5	20.90	43.8	8.37	14.55	6.75	1.09	22.18	24.47	14.23	1.68
21.0	19.66	45.6	7.95	7.38	8.13	0.93	22.29	25.31	13.99	1.90
21.5	17.38	47.2	8.55	4.46	10.28	0.72	23.65	26.41	14.79	2.05
22.0	15.40	47.6	9.82	3.93	13.03	0.65	24.99	25.28	14.89	2.17

Typical Performance Data

NOTE: Use PDF Bookmarks to view DATA at required conditions

Definitions:

Input Return Loss = -S11 (dB)

Gain(Power Gain) = S21 (dB)

Reverse Isolation = -S12 (dB)

Output Return Loss = -S22 (dB)

TEST CONDITIONS: $V_{DD} = +5\text{ V}$, $I_{DD} = 49\text{ mA}$ @ Temperature = +85°C

FREQ	Gain	Isolation	Input Return Loss	Output Return Loss	Stability		IP-3 Output $P_{OUT} = 0\text{ dBm/}$ Tone	IP-3 Output $P_{OUT} = +5\text{ dBm/}$ Tone	1dB Comp. Output	Noise Figure
					K	Measure				
(GHz)	(dB)	(dB)	(dB)	(dB)			(dBm)	(dBm)	(dBm)	(dB)
10.0	18.12	52.5	13.50	5.02	18.98	0.72	19.08	17.50	10.39	2.41
10.2	18.41	52.8	13.98	5.53	20.25	0.75	19.64	18.56	11.11	2.39
10.4	18.56	53.1	14.13	5.95	21.37	0.78	19.63	18.72	11.46	2.35
10.6	18.65	54.0	14.17	6.36	24.21	0.80	20.34	19.54	11.47	2.25
10.8	18.73	54.2	13.65	6.96	25.50	0.84	20.66	19.76	11.70	2.22
11.0	18.78	55.1	13.31	7.55	29.08	0.86	20.12	18.87	12.01	2.17
11.2	18.84	56.1	13.20	8.15	33.30	0.89	21.29	20.47	12.05	2.11
11.4	18.94	57.9	12.85	8.96	41.45	0.92	21.64	20.56	12.18	2.07
11.6	19.04	57.6	12.70	9.86	40.98	0.94	22.00	21.15	12.49	2.05
11.8	19.16	58.4	12.83	10.89	45.18	0.97	21.33	20.28	12.52	1.96
12.0	19.29	58.4	12.86	12.53	45.91	0.99	22.08	20.97	12.75	1.98
12.2	19.43	58.0	12.87	14.76	44.42	1.01	22.44	21.49	12.93	1.93
12.4	19.55	57.8	12.88	17.77	43.53	1.03	22.56	21.69	13.11	1.95
12.5	19.60	58.0	12.82	20.07	44.73	1.04	22.49	21.31	13.16	1.96
12.6	19.64	57.7	12.69	23.47	43.11	1.05	22.50	21.47	13.27	1.91
12.8	19.71	57.1	12.21	34.45	39.81	1.06	22.52	21.56	13.45	1.89
13.0	19.74	56.3	11.64	26.53	35.82	1.07	23.13	22.25	13.52	1.86
13.2	19.76	55.7	11.05	20.67	33.07	1.07	23.12	22.53	13.47	1.90
13.4	19.80	54.7	10.45	17.81	28.73	1.07	23.35	22.62	13.62	1.85
13.6	19.86	53.9	9.87	16.32	25.37	1.08	23.99	23.22	13.58	1.89
13.8	19.94	53.0	9.40	15.26	22.32	1.08	23.94	23.26	13.59	1.83
14.0	20.02	52.2	9.08	14.42	19.88	1.08	23.92	23.29	13.63	1.88
14.2	20.13	51.4	8.77	13.82	17.52	1.09	23.64	22.75	13.75	1.83
14.4	20.22	50.5	8.49	13.16	15.42	1.09	24.22	23.74	13.74	1.85
14.6	20.30	49.7	8.31	12.50	13.73	1.08	24.04	23.19	13.74	1.85
14.8	20.38	48.8	8.09	12.01	12.04	1.08	23.86	23.18	13.81	1.87
15.0	20.47	48.1	7.84	11.54	10.85	1.08	24.74	24.26	13.74	1.91
15.2	20.55	47.2	7.74	11.36	9.71	1.08	24.02	23.45	13.73	1.90
15.4	20.65	46.5	7.62	11.32	8.78	1.09	23.81	23.50	13.77	1.90
15.6	20.72	45.7	7.53	11.33	7.96	1.09	23.75	23.40	13.84	1.98
15.8	20.78	45.2	7.66	11.50	7.46	1.08	24.44	24.04	14.02	1.94
16.0	20.85	44.5	7.81	11.71	6.96	1.08	23.82	23.38	13.97	1.96
16.2	20.87	44.0	7.96	11.88	6.63	1.07	23.94	23.55	14.04	2.01
16.4	20.85	43.5	8.19	12.12	6.38	1.07	23.33	23.57	14.26	2.01
16.6	20.83	43.1	8.35	12.65	6.22	1.07	23.12	23.16	14.15	2.03
16.8	20.71	42.9	8.36	13.16	6.22	1.07	22.82	22.65	14.38	2.04
17.0	20.57	42.7	8.32	14.17	6.24	1.09	22.87	22.66	14.54	2.04
17.2	20.44	42.6	8.27	15.47	6.34	1.10	23.02	22.98	14.63	2.04
17.4	20.24	42.5	8.18	16.92	6.42	1.11	23.30	23.24	14.84	2.10
17.6	20.04	42.4	8.19	18.72	6.52	1.12	22.40	22.44	15.10	2.14
17.8	19.85	42.2	8.34	20.60	6.63	1.12	23.14	23.27	15.15	2.16
18.0	19.63	42.0	8.57	22.59	6.71	1.12	22.96	22.94	15.43	2.20
18.2	19.45	42.0	8.84	23.22	6.91	1.12	22.94	23.05	15.56	2.22
18.4	19.23	42.0	9.06	22.17	7.16	1.11	22.72	22.53	15.60	2.27
18.6	19.02	42.0	9.38	19.63	7.40	1.10	22.76	22.71	15.76	2.31
18.8	18.79	42.1	9.59	17.61	7.68	1.08	22.94	22.82	15.86	2.37
19.0	18.56	42.2	9.60	17.12	8.00	1.08	23.19	23.18	15.89	2.42
19.2	18.30	42.3	9.66	15.54	8.27	1.07	22.36	22.55	15.86	2.49
19.4	18.09	42.5	9.50	15.49	8.69	1.07	22.65	22.84	15.92	2.55
19.6	17.87	42.8	9.14	16.07	9.10	1.09	23.03	23.05	15.50	2.66
19.8	17.66	43.1	8.91	16.58	9.63	1.10	21.74	22.45	14.98	2.75
20.0	17.38	43.6	8.66	15.70	10.38	1.10	22.30	22.79	15.30	2.87
20.5	16.40	44.9	8.29	10.38	12.56	1.04	22.33	22.65	14.74	3.14
21.0	14.78	46.5	8.40	6.90	16.07	0.90	22.35	22.14	14.50	3.39
21.5	12.80	47.3	8.87	5.21	19.87	0.78	22.61	20.61	14.06	3.70
22.0	10.78	47.8	9.57	4.24	24.16	0.69	20.71	17.30	12.05	3.79

Typical Performance Data

NOTE: Use PDF Bookmarks to view DATA at required conditions

Definitions:

Input Return Loss = -S11 (dB)

Gain(Power Gain) = S21 (dB)

Reverse Isolation = -S12 (dB)

Output Return Loss = -S22 (dB)

TEST CONDITIONS: $V_{DD} = +5\text{ V}$, $I_{DD} = 47\text{ mA}$ @ Temperature = $+105^{\circ}\text{C}$

FREQ	Gain	Isolation	Input Return Loss	Output Return Loss	Stability		IP-3 Output $P_{OUT} = 0\text{ dBm/}$ Tone	IP-3 Output $P_{OUT} = +5\text{ dBm/}$ Tone	1dB Comp. Output	Noise Figure
					K	Measure				
(GHz)	(dB)	(dB)	(dB)	(dB)			(dBm)	(dBm)	(dBm)	(dB)
10.0	17.59	52.4	13.09	5.14	20.18	0.73	18.48	16.38	9.55	2.62
10.2	17.89	52.9	13.53	5.66	21.97	0.76	19.04	17.43	10.33	2.61
10.4	18.05	53.2	13.69	6.10	23.15	0.79	19.17	17.56	10.63	2.52
10.6	18.15	53.8	13.75	6.53	25.34	0.81	19.87	18.27	10.69	2.43
10.8	18.24	54.3	13.30	7.15	27.63	0.85	19.99	18.54	10.93	2.42
11.0	18.30	54.7	13.00	7.75	29.62	0.87	19.50	17.65	11.17	2.32
11.2	18.36	56.0	12.92	8.36	35.01	0.90	20.72	19.41	11.17	2.29
11.4	18.47	57.4	12.61	9.20	42.03	0.93	21.05	19.53	11.28	2.26
11.6	18.58	57.7	12.47	10.16	43.66	0.95	21.29	20.34	11.66	2.24
11.8	18.71	58.3	12.64	11.27	47.42	0.98	20.76	19.18	11.68	2.16
12.0	18.84	58.1	12.70	13.04	47.25	1.00	21.15	19.82	11.84	2.16
12.2	18.97	57.9	12.73	15.49	46.64	1.02	21.60	20.57	12.03	2.14
12.4	19.08	57.7	12.77	18.85	45.66	1.04	22.01	20.75	12.28	2.09
12.5	19.13	57.4	12.72	21.48	44.41	1.05	21.87	20.25	12.25	2.10
12.6	19.17	57.2	12.58	25.58	43.11	1.05	21.77	20.45	12.36	2.08
12.8	19.23	56.7	12.10	31.93	40.32	1.06	21.68	20.54	12.55	2.08
13.0	19.26	56.0	11.53	24.60	36.59	1.07	22.54	21.29	12.69	2.05
13.2	19.27	55.5	10.92	19.74	33.83	1.07	22.66	21.46	12.56	2.03
13.4	19.31	54.5	10.32	17.23	29.67	1.07	22.66	21.63	12.76	1.98
13.6	19.36	53.7	9.76	15.88	26.09	1.08	23.62	22.35	12.77	2.07
13.8	19.43	52.9	9.30	14.91	23.42	1.08	23.35	22.31	12.76	2.03
14.0	19.51	51.9	9.00	14.11	20.37	1.08	23.42	22.48	12.83	2.04
14.2	19.63	51.1	8.71	13.57	17.94	1.09	22.87	21.83	12.95	2.00
14.4	19.72	50.2	8.44	12.98	15.85	1.09	23.48	22.97	13.00	2.03
14.6	19.80	49.5	8.28	12.41	14.17	1.08	23.41	22.38	12.95	2.05
14.8	19.90	48.6	8.07	12.01	12.57	1.08	23.36	22.30	13.15	2.02
15.0	19.98	48.0	7.83	11.61	11.35	1.09	24.24	23.45	13.01	2.10
15.2	20.06	47.2	7.74	11.47	10.22	1.09	23.34	22.73	12.95	2.10
15.4	20.16	46.4	7.64	11.41	9.19	1.09	23.35	22.72	13.07	2.13
15.6	20.24	45.7	7.58	11.39	8.42	1.09	23.10	22.68	13.07	2.13
15.8	20.30	45.0	7.74	11.48	7.83	1.08	23.81	23.40	13.31	2.15
16.0	20.38	44.4	7.92	11.64	7.33	1.08	22.65	22.70	13.34	2.16
16.2	20.40	43.9	8.11	11.76	6.96	1.07	23.43	23.01	13.40	2.16
16.4	20.38	43.5	8.38	12.00	6.75	1.06	23.45	23.05	13.55	2.16
16.6	20.37	43.2	8.57	12.57	6.64	1.06	22.91	22.56	13.39	2.21
16.8	20.25	42.9	8.59	13.13	6.61	1.07	22.34	22.02	13.59	2.19
17.0	20.11	42.8	8.54	14.17	6.71	1.08	22.27	22.10	13.74	2.24
17.2	19.99	42.6	8.48	15.48	6.70	1.09	22.73	22.33	13.92	2.26
17.4	19.78	42.5	8.36	16.94	6.86	1.11	22.79	22.66	14.12	2.31
17.6	19.58	42.4	8.37	18.60	6.95	1.12	21.81	21.98	14.32	2.34
17.8	19.39	42.2	8.50	20.45	7.04	1.12	22.67	22.88	14.38	2.34
18.0	19.17	42.1	8.71	22.00	7.18	1.12	22.55	22.47	14.78	2.39
18.2	18.97	42.0	8.96	22.35	7.41	1.11	22.67	22.48	14.85	2.46
18.4	18.76	42.0	9.17	21.62	7.62	1.11	22.28	22.16	14.86	2.47
18.6	18.53	42.1	9.47	19.35	7.93	1.09	22.28	22.16	14.93	2.55
18.8	18.30	42.2	9.66	17.61	8.26	1.08	22.59	22.35	15.05	2.56
19.0	18.07	42.3	9.64	17.24	8.61	1.08	23.01	22.83	15.08	2.66
19.2	17.81	42.4	9.66	15.75	8.95	1.07	21.87	22.21	14.93	2.71
19.4	17.58	42.7	9.47	15.66	9.44	1.08	22.50	22.49	15.02	2.79
19.6	17.35	42.9	9.10	16.19	9.83	1.09	23.03	22.89	14.82	2.89
19.8	17.12	43.3	8.85	16.49	10.48	1.10	21.46	22.16	14.41	3.01
20.0	16.81	43.8	8.61	15.28	11.35	1.10	22.04	22.59	14.68	3.07
20.5	15.75	45.2	8.25	10.10	14.01	1.03	21.82	22.66	14.27	3.39
21.0	14.05	46.7	8.36	6.72	17.80	0.90	22.33	21.30	13.70	3.67
21.5	12.07	47.5	8.84	5.12	22.01	0.78	22.09	18.89	12.15	4.01
22.0	10.15	47.8	9.61	4.31	26.56	0.70	19.41	15.32	9.85	4.07

Typical Performance Curves

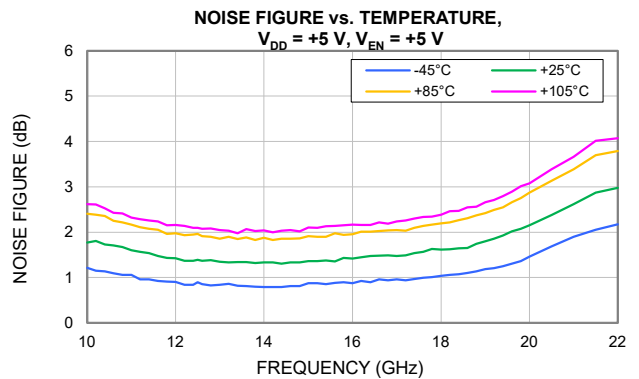
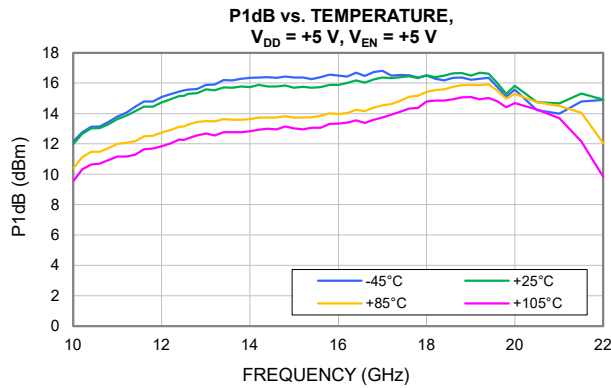
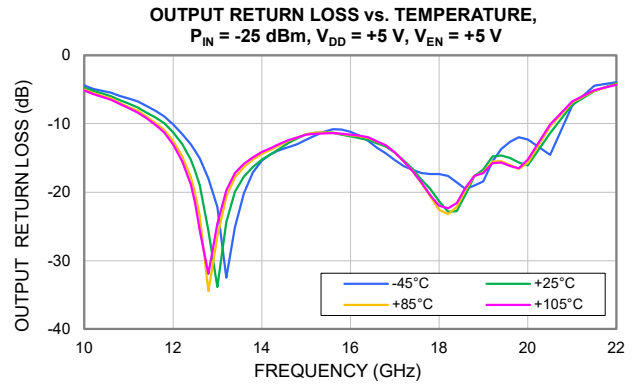
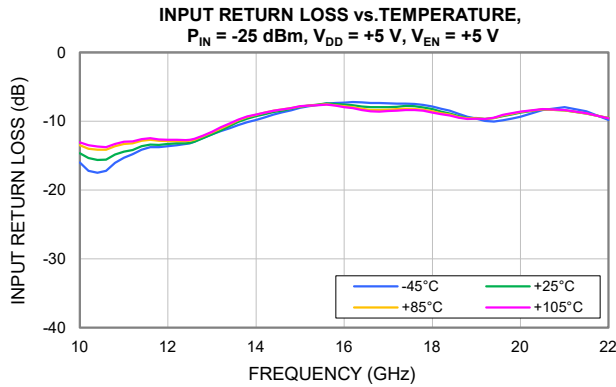
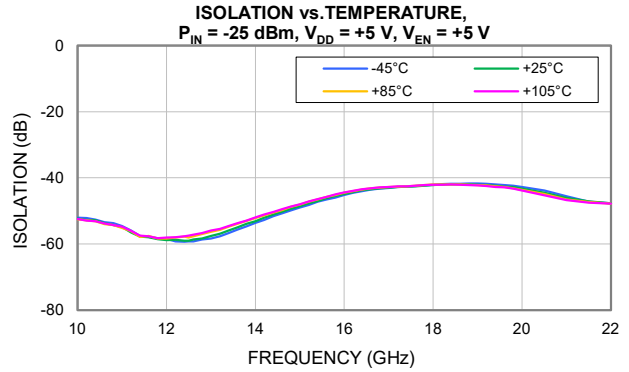
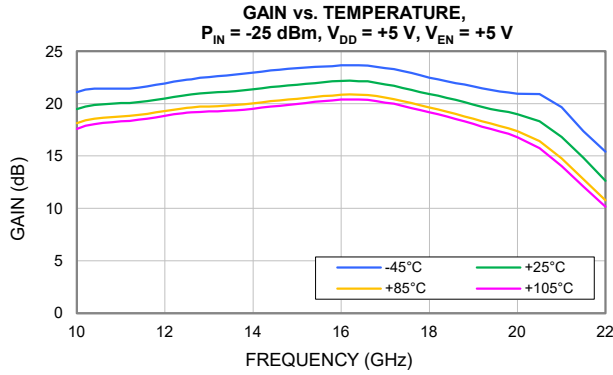

Typical Performance Curves

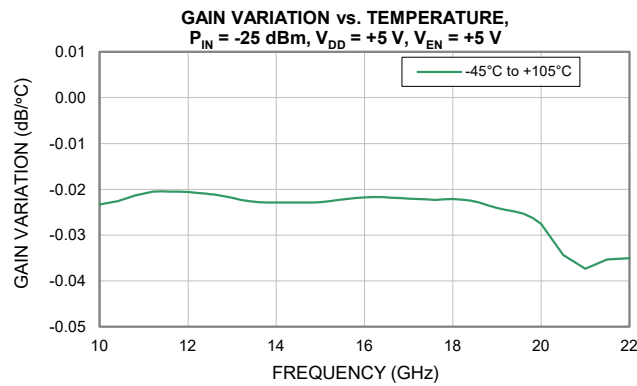
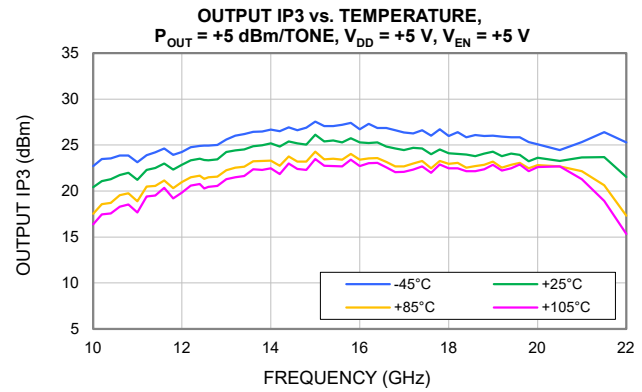
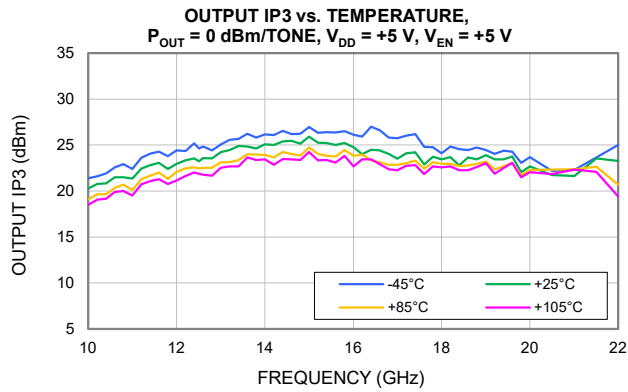

Case Style

DQ

Outline Dimensions

DQ3005

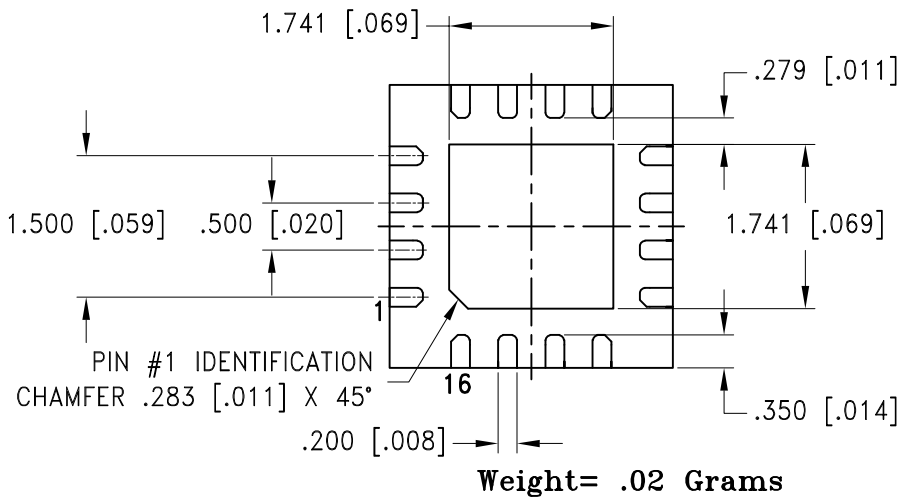
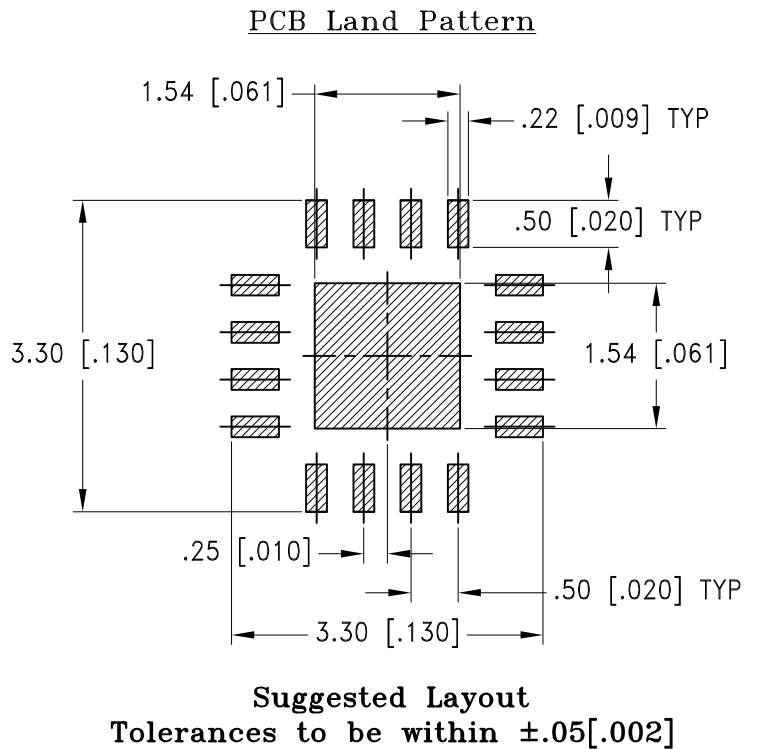
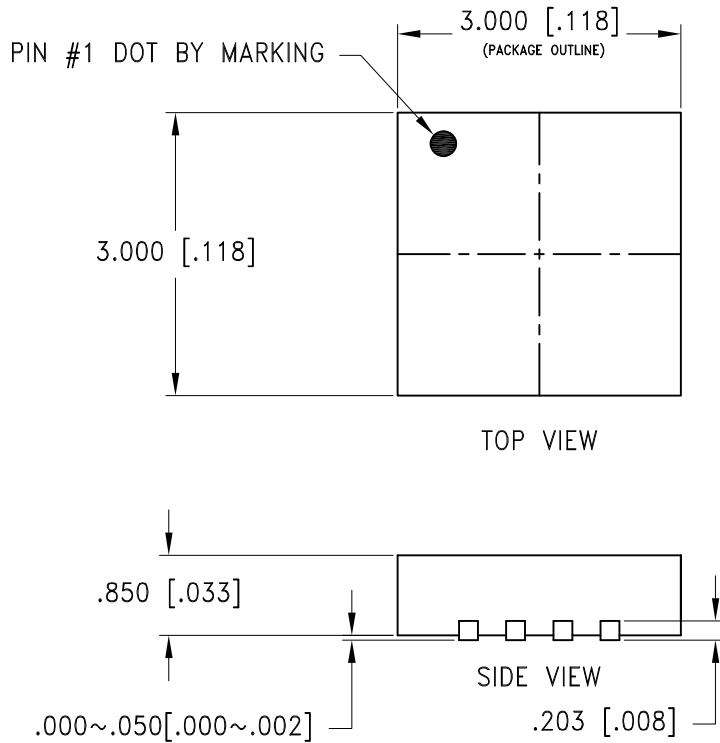

Dimensions are in mm[inches]. Tolerances: 3 Pl. ± 0.05 [.002]

Notes:

1. Case material: Plastic.
2. Termination finish:
For RoHS Case Styles: Matte-Tin. All models, (+) suffix.
For RoHS-5 Case Styles: Tin-Lead plate. All models, no (+) suffix.

Mini-Circuits[®]

INTERNET <http://www.minicircuits.com>

P.O. Box 350166, Brooklyn, New York 11235-0003 (718) 934-4500 Fax (718) 332-4661

Distribution Centers NORTH AMERICA 800-654-7949 • 417-335-5935 • Fax 417-335-5945 • EUROPE 44-1252-832600 • Fax 44-1252-837010

Mini-Circuits ISO 9001 & ISO 14001 Certified

THIRD ANGLE PROJECTION

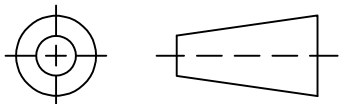

REVISIONS

REV	ECN No.	DESCRIPTION	DATE	DR	AUTH
OR	ECO-021935	NEW RELEASE	06/10/24	GF	IL

SUGGESTED MOUNTING CONFIGURATION FOR
DQ3005 CASE STYLE

∅.008 PTH FOR GROUND,
PLUGGED FROM TOP SIDE
& CAPPED WITH COPPER, 90 PL.

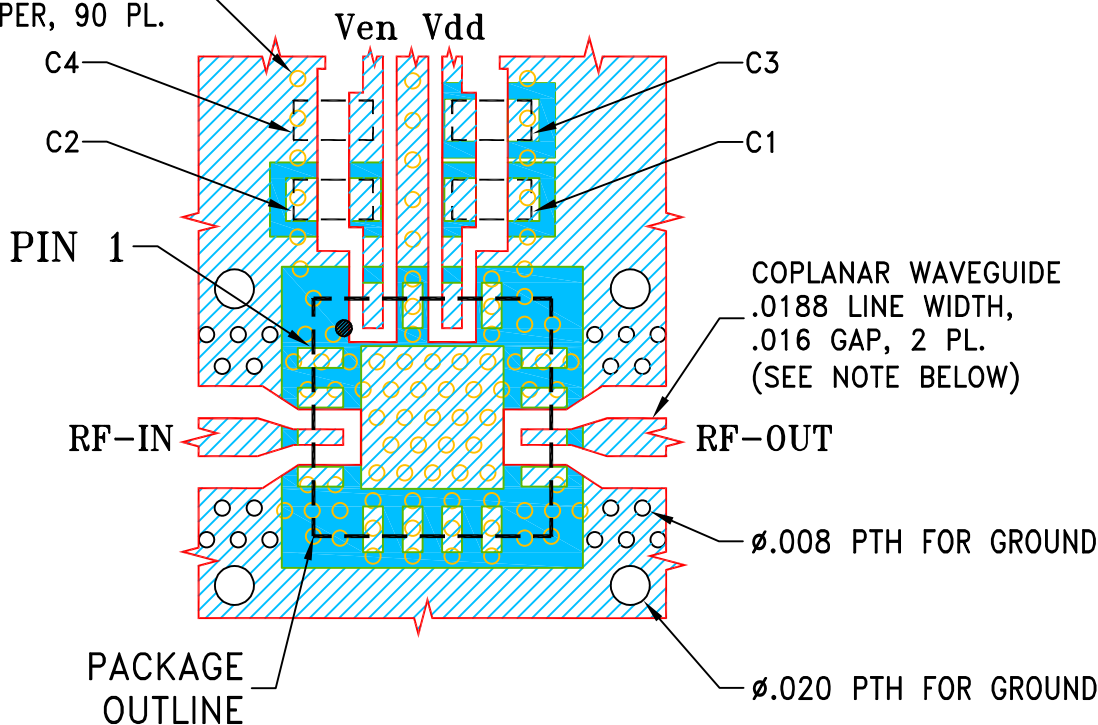

COMPONENT	SIZE
C1,C2,C3,C4	0402

NOTES:

1. TRACE WIDTH AND GAP ARE SHOWN FOR ROGERS R04350B WITH DIELECTRIC THICKNESS .010"; COPPER: 1 OZ. ON EACH SIDE.
FOR OTHER MATERIALS TRACE WIDTH AND GAP MAY NEED TO BE MODIFIED.
2. CHIP COMPONENT FOOT PRINTS SHOWN FOR REFERENCE. FOR COMPONENT VALUES REFER TO TB-PMA3-10203+ OR TB-PMA3-10203C+.
3. BOTTOM SIDE OF THE PCB IS CONTINUOUS GROUND PLANE.



DENOTES PCB COPPER LAYOUT WITH SMOBC (SOLDER MASK OVER BARE COPPER).

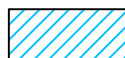

DENOTES COPPER LAND PATTERN FREE OF SOLDER MASK.

UNLESS OTHERWISE SPECIFIED	INITIALS	DATE
DIMENSIONS ARE IN INCHES	DRAWN GF	06/07/24
TOLERANCES ON:	CHECKED IL	06/10/24
2 PL DECIMALS ±	APPROVED IL	06/10/24
3 PL DECIMALS ± .005		
ANGLES ±		
FRACTIONS ±		

 **Mini-Circuits®** 13 Neptune Avenue
Brooklyn NY 11235

PL,DQ3005,TB-PMA3-10203+/10203C+

SIZE A	CODE IDENT 15542	DRAWING NO: 98-PL-784	REV: OR
FILE: 98PL784	SCALE: 10:1	SHEET: 1 OF 1	

 Mini-Circuits®
THIS DOCUMENT AND ITS CONTENTS ARE THE PROPERTY OF MINI-CIRCUITS.
EXCEPT FOR USE EXPRESSLY GRANTED, IN WRITING, TO ITS VENDORS, VENDEE
AND THE UNITED STATES GOVERNMENT, MINI-CIRCUITS RESERVES ALL PROPRIETARY
DESIGN, USE, MANUFACTURING AND REPRODUCTION RIGHTS THERETO.
THESE CONTENTS SHALL NOT BE USED, DUPLICATED OR DISCLOSED TO ANY OUTSIDE
PARTY, IN WHOLE OR IN PART, WITHOUT WRITTEN PERMISSION OF MINI-CIRCUITS.

Evaluation Board and Circuit

SEE DETAIL "A"

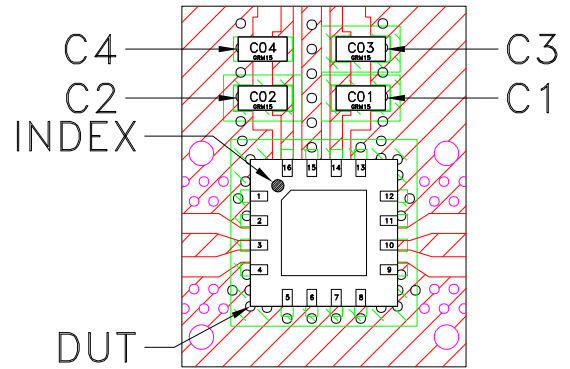
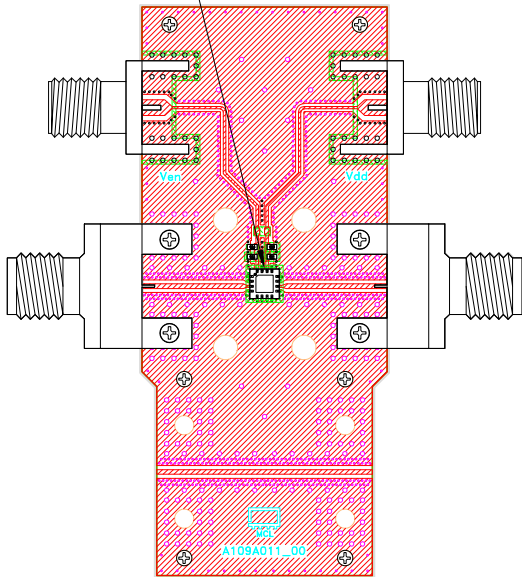

DETAIL "A"
LOCATION OF
UNITS COMPONENTS
(SCALE 5:1)

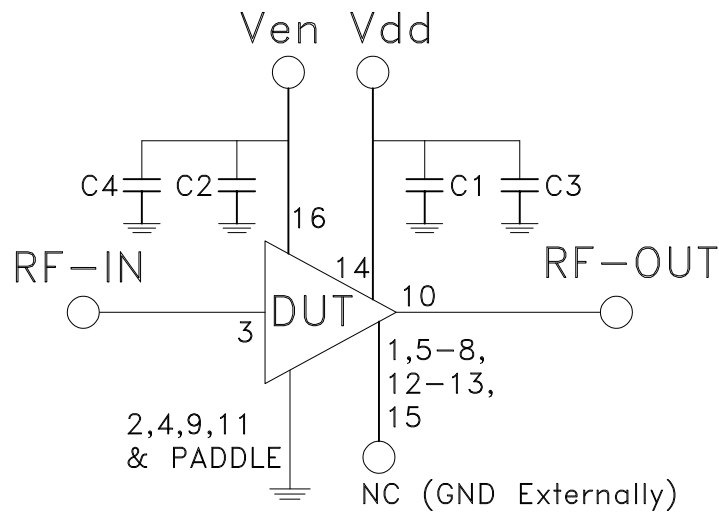

SCHEMATIC DIAGRAM

Component	Size	Value	Part Number	Manufacturer
C1,C2	0402	100pF	GRM1555C1H101JA01D	Murata
C3,C4	0402	0.1uF	GRM155R71H104KE14J	Murata

Notes:

1. 2.92mm Female Connectors.
2. PCB Material: Roger R04350B or equivalent,
Dielectric constant=3.5, Thickness=0.010 inch

 **Mini-Circuits®**

All Mini-Circuits products are manufactured under exacting quality assurance and control standards, and are capable of meeting published specifications after being subjected to any or all of the following physical and environmental test.

Specification	Test/Inspection Condition	Reference/Spec
Operating Temperature	-40° to 85°C or -45° to 85°C Ambient Environment	Individual Model Data Sheet
Storage Temperature	-55° to 100° C or -65° to 150° Ambient Environment	Individual Model Data Sheet
Thermal Shock	-55° to 100°C, 100 cycles	MIL-STD-202, Method 107, Condition A-3, except +100°C
Mechanical Shock	1.5Kg, 0.5 ms, 5 shock pulses, Y1 direction only	MIL-STD-883, Method 2002, Condition B, except Y1 direction only
Vibration (Variable Frequency)	50g peak	MIL-STD-883, Method 2007, Condition B
Autoclave	15 psig, 100% RH, 121°C, 96 hours	JESD22-A102, Condition C
HAST	130°C, 85% RH, 96 hours	JESD22-A110
Solderability	10X Magnification	J-STD-002, Para 4.2.5, Test S, 95% Coverage
Solder Reflow Heat	Sn-Pb Eutetic Process: 240°C peak Pb-Free Process: 260°C peak	J-STD-020, Table 4-1, 4-2 and 5-2; Figure 5-1
Moisture Sensitivity: Level 1	Bake at 125°C for 24 hours Soak at 85°C/85% RH for 168 hours, Reflow 3 cycles at 260°C peak	J-STD-020
Marking Resistance to Solvents	Isopropyl alcohol + mineral spirits at 25°C; terpene defluxer at 25°C; distilled water + proylene glycol monomethyl ether +	MIL-STD-202, Method 215



All Mini-Circuits products are manufactured under exacting quality assurance and control standards, and are capable of meeting published specifications after being subjected to any or all of the following physical and environmental test.

Specification	Test/Inspection Condition	Reference/Spec
	monoethanolamine at 63°C to 70°C	